

SOJAG

produits saisonniers • seasonal products



Sojag code: 448-8163018

CUP/UPC code: 772830163018

QUESTIONS? 1 866-901-1649

Assembly Manual / Guide d'assemblage / Manual de ensamblaje / 조립설명서 / Montageanleitung

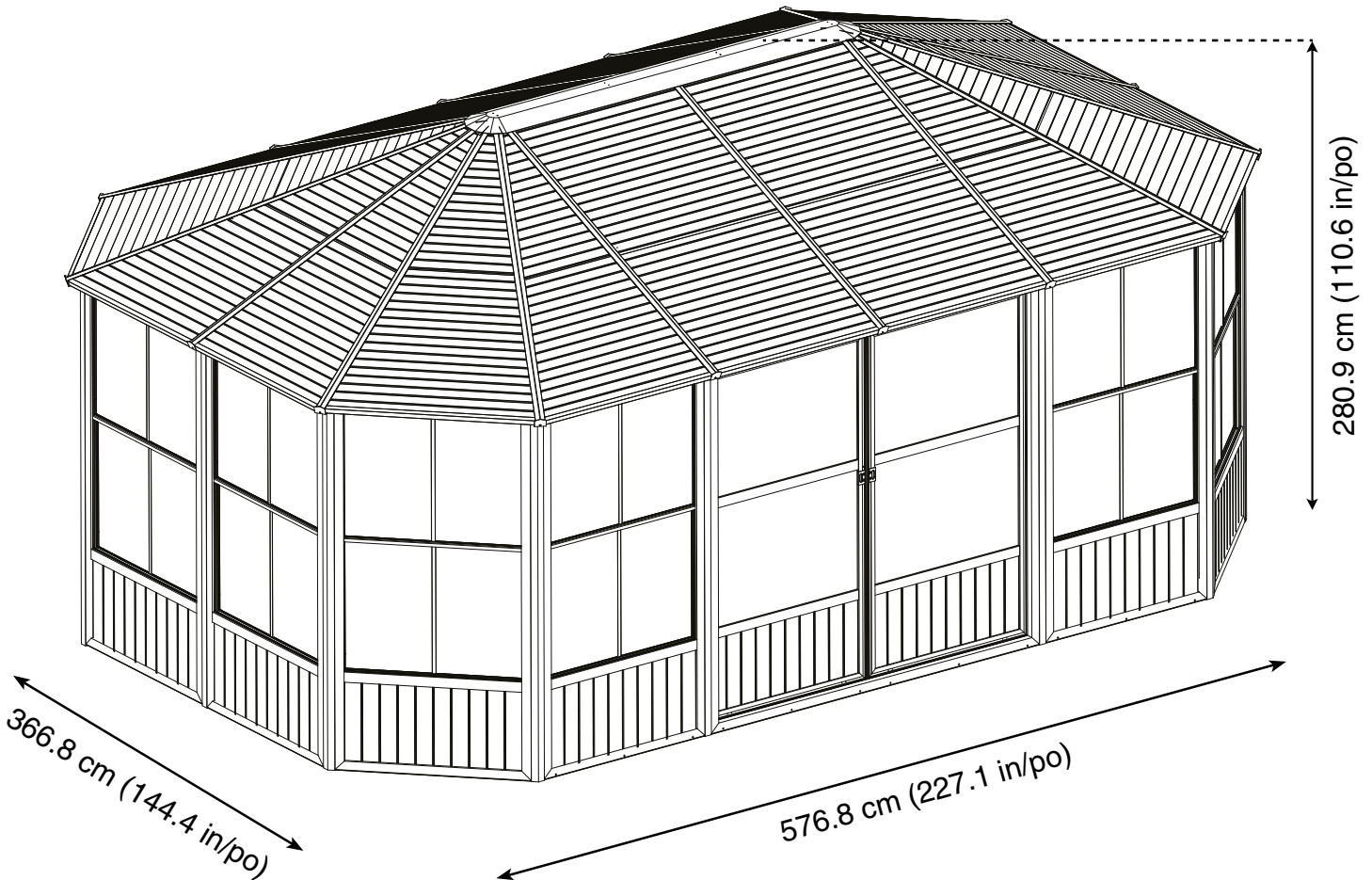

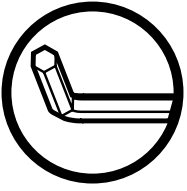

Use the hex keys in the box. / Utiliser les clés hexagonales fournies dans la boîte. /
Utilice las llaves hexagonales en la caja. / 상자에 육각 키를 사용 하십시오. / Verwenden Sie
die Sechskantschlüssel in der Box.

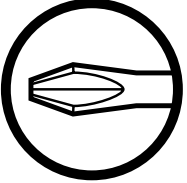

Please use a Phillips screwdriver. / Utiliser un tournevis de type Phillips / Por favor, use
un destornillador Phillips / 십자 드라이버를 사용 하십시오. / Bitte verwenden Sie einen
Kreuzschraubenzieher.



You may need to use a drill for this step. / Cette étape peut nécessiter l'utilisation
d'une perceuse. / puede que tenga que utilizar un taladro para este paso. /
이 단계에선 드릴을 사용해야 할 수도 있습니다. / Für diesen Schritt können Sie einen
Bohrer verwenden.



Wearing protective gloves is recommended. / Le port de gants de protection est recommandé /
El uso de guantes de protección se recomienda / 보호 장갑을 착용 하는 것이 좋습니다. /
Das Tragen von Schutzhandschuhen wird empfohlen.



Two or more people are required at this stage. / Deux personnes ou plus sont nécessaires à cette
étape. / Dos o más personas se requieren en esta etapa. / 이 단계에서는 두 명 이상이 필요합니다. /
Für diesen Bauschritt sind 2 oder mehr Personen erforderlich.



Do not screw firmly for now. / Ne pas visser fermement pour l'instant. / No atornille con
firmeza por ahora. / 아직 나사를 단단히 조이지 마십시오. / Bitte die Schrauben zum
jetzigen Zeitpunkt noch nicht fest anziehen.



Sold separately / Vendus séparément / vendido en las opciones /
옵션 판매 / Optional erhältlich

B6 X 8 (+2)

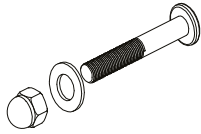

R X 2 (+1)

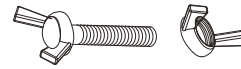

S X 64 (+6)

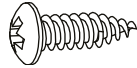

S1 X 16 (+2)

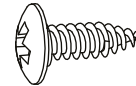

T X 40 (+6)

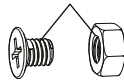

U X 80 (+8)

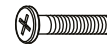

V X 70 (+7)



V1 X 4 (+1)

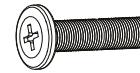

V2 X 8 (+2)



V3 X 2 (+1)

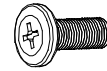

W X 12 (+2)

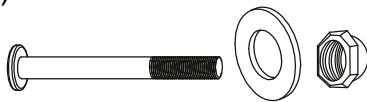

X X 12 (+2)



Y X 3 (+1)



Z1 X 8

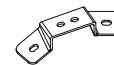

Z2 X 8

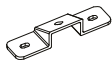



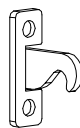



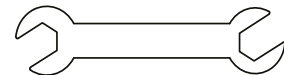

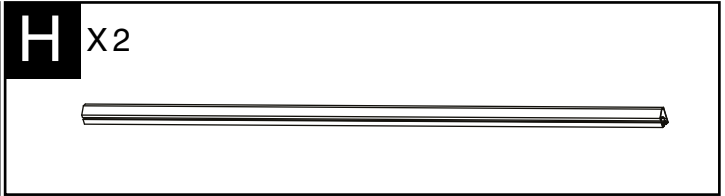
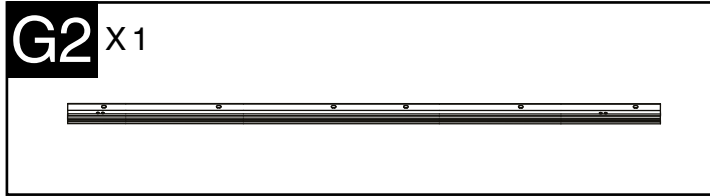
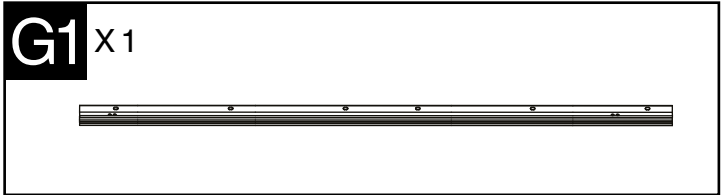
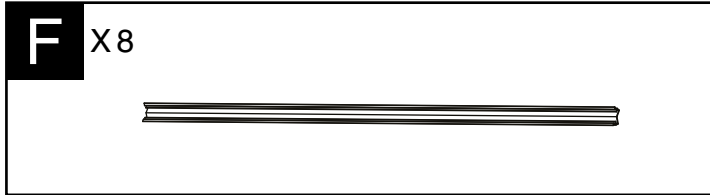
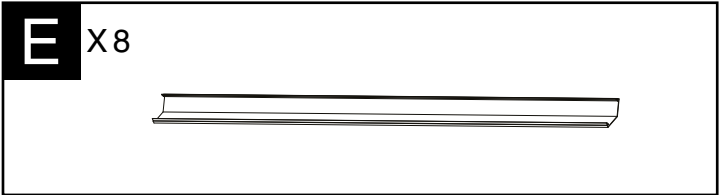
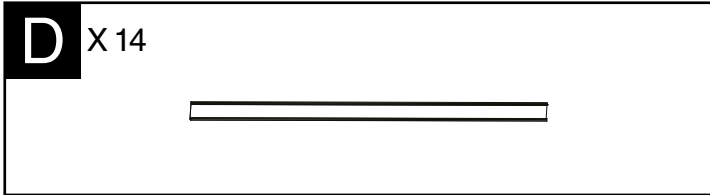
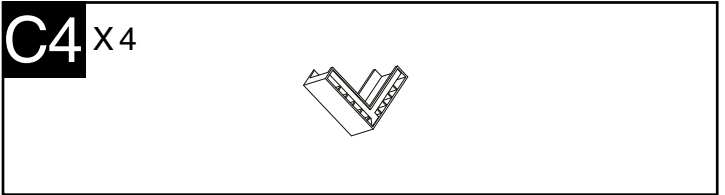
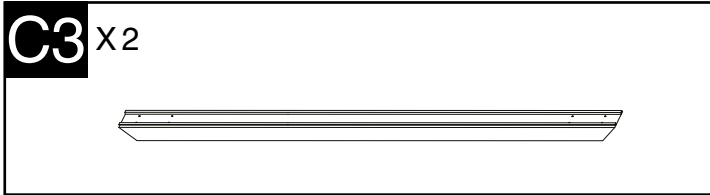
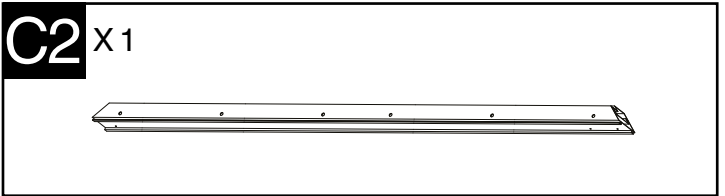
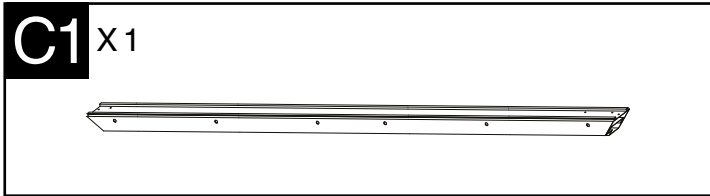
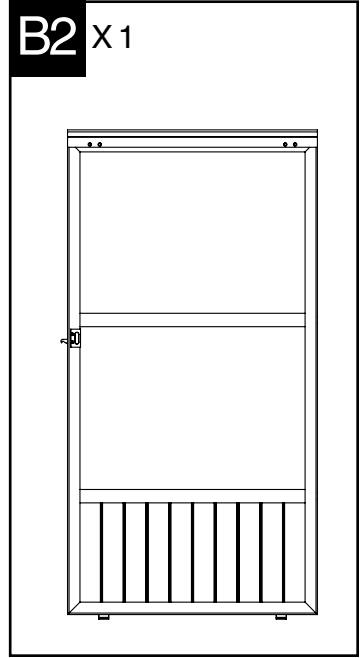
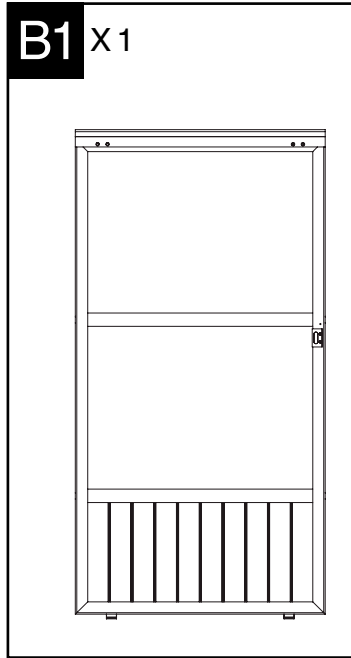
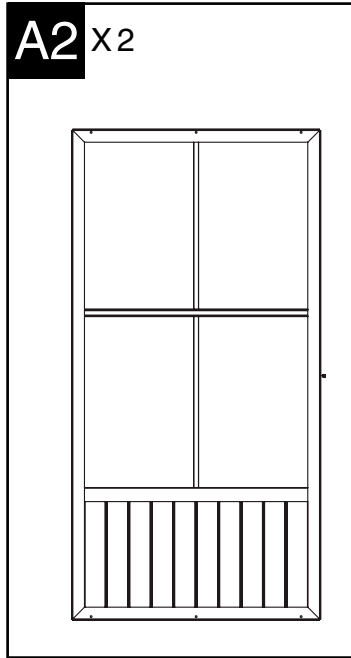
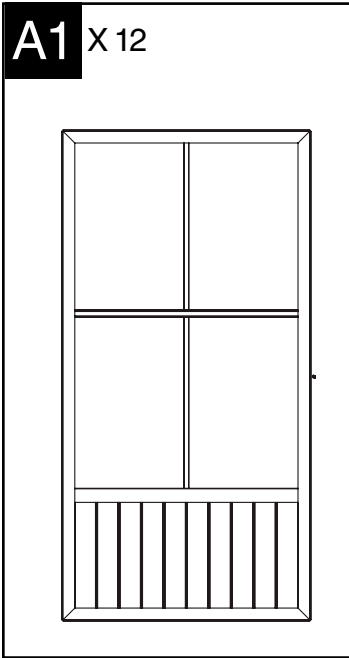



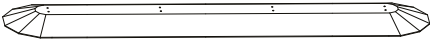

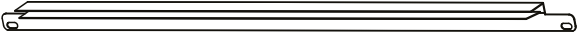
Z3 X 1

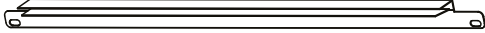

Z4 X 1



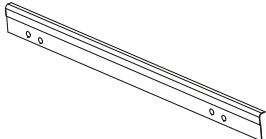

I X4 	J X1 
K X1 	L1 X8 
L2 X8 	M X8 
M1 X4 	M2 X4 
N X8 	N1 X4 
N2 X4 	P X8 
P1 X4 	P2 X4 
O X8 	O1 X8 

B7 X2 

B5 X4



Q X16



Qa X4

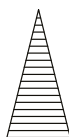

Qb X4

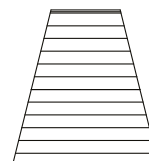

Qc X4

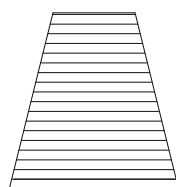

R1 X2

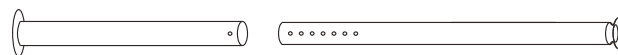

Ra X4

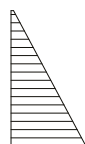

Rb X4

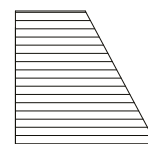

R1a X4

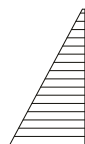

R1b X4

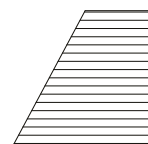

Sa X4

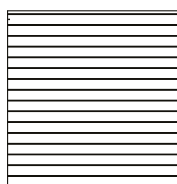

Sb X4

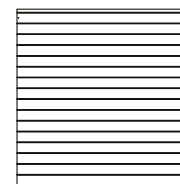

Z X3

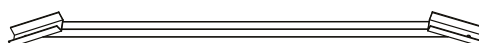

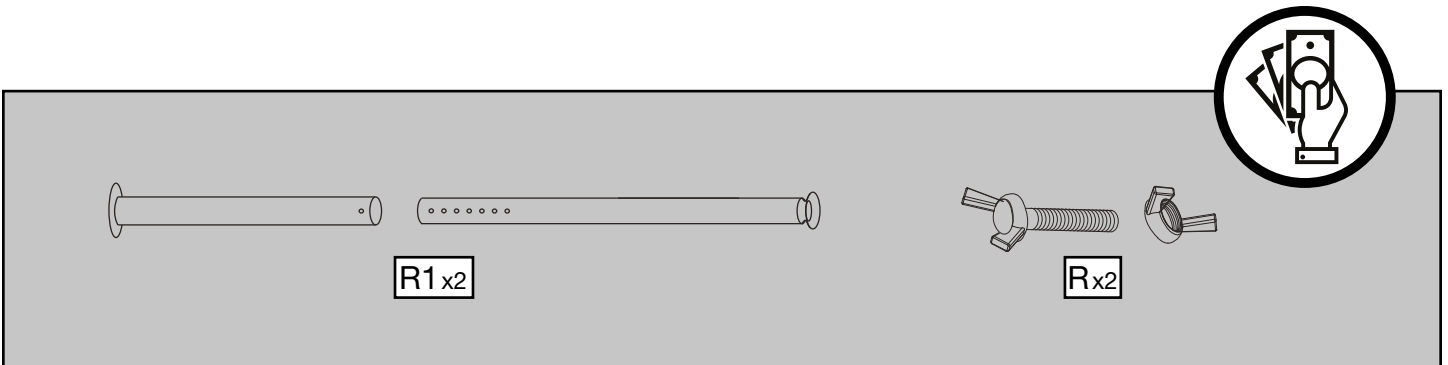
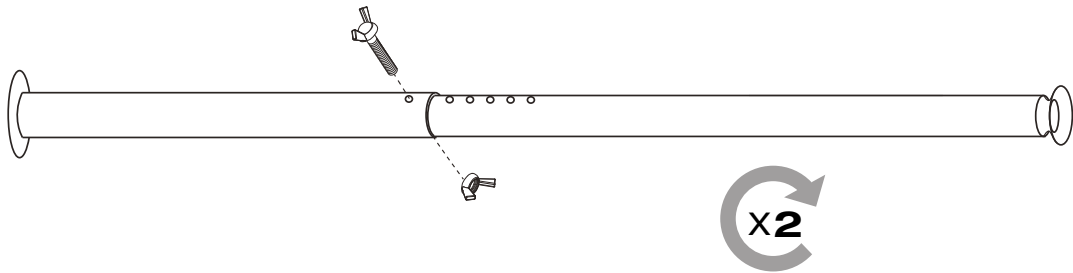
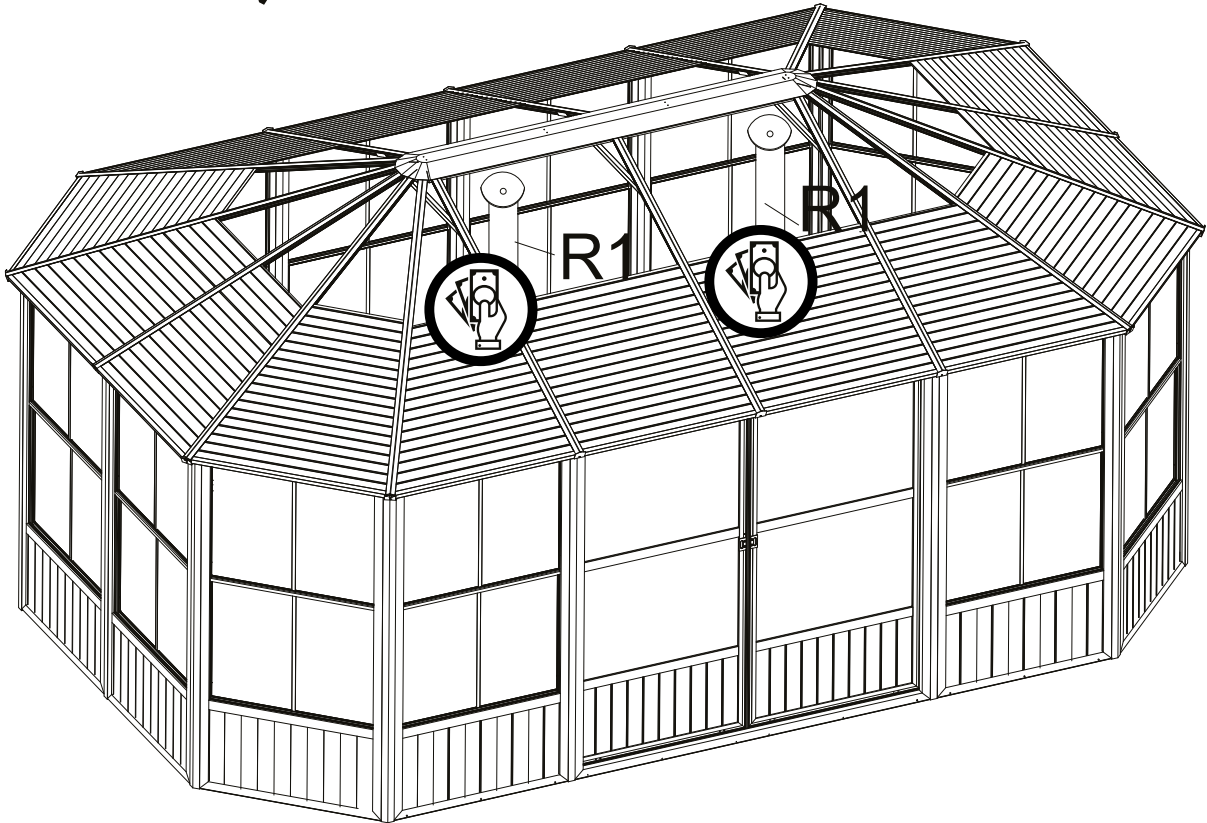
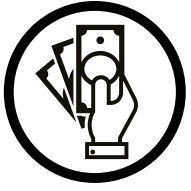

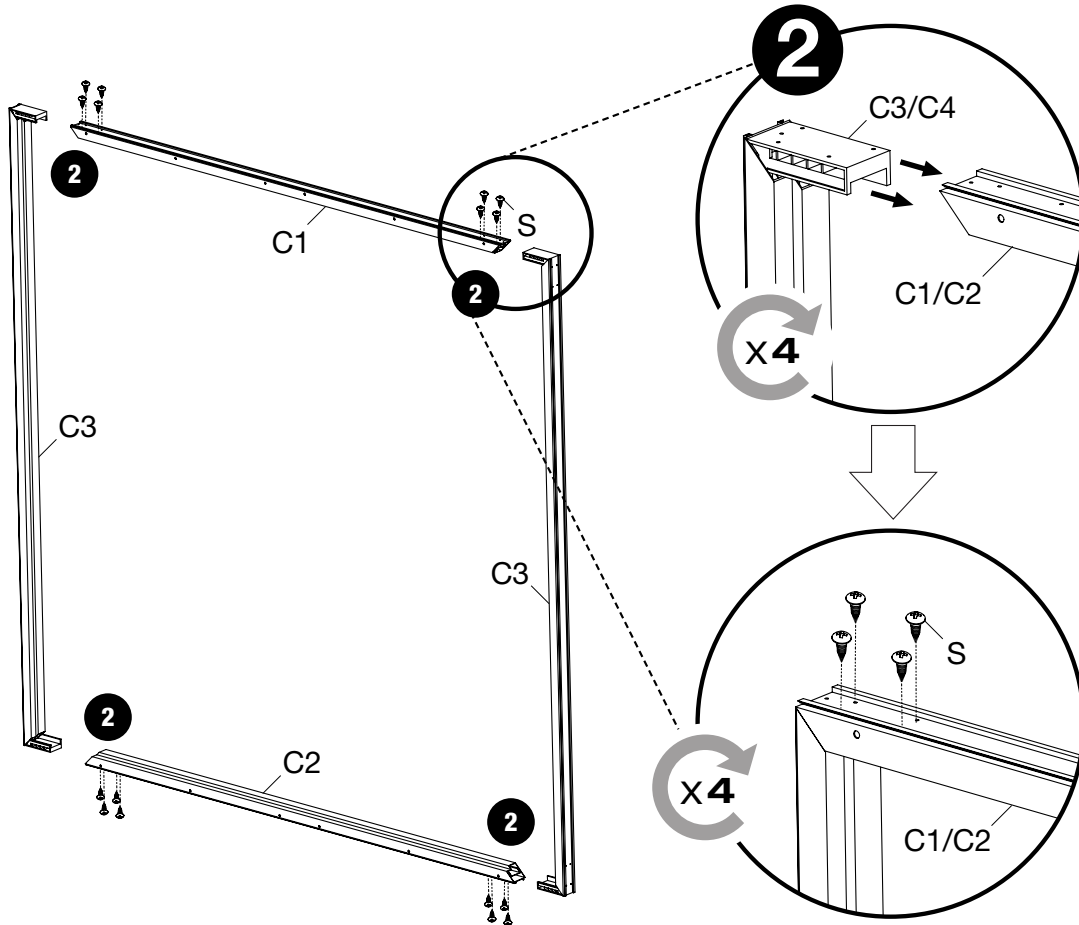
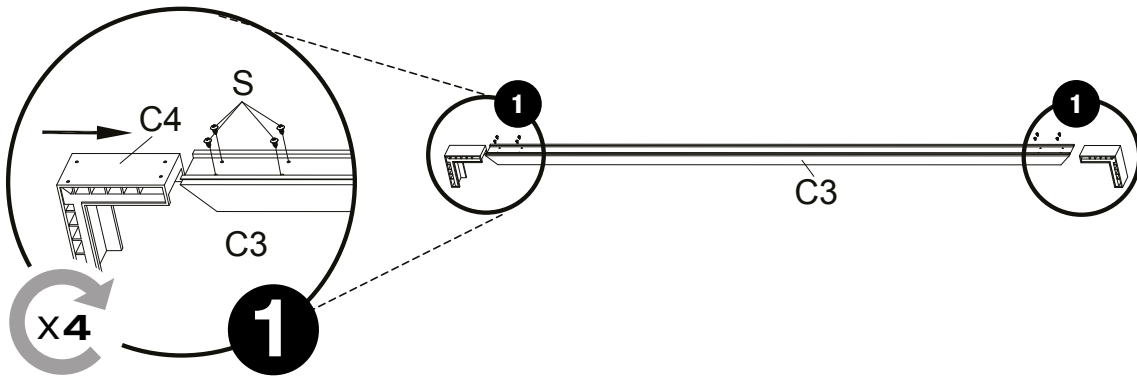

Parts list and icons for assembly:

- C1x1
- C2x1
- C3x2
- C4x4
- Sx32

Icons: 2+ people, a hand holding a tool, and a screw.

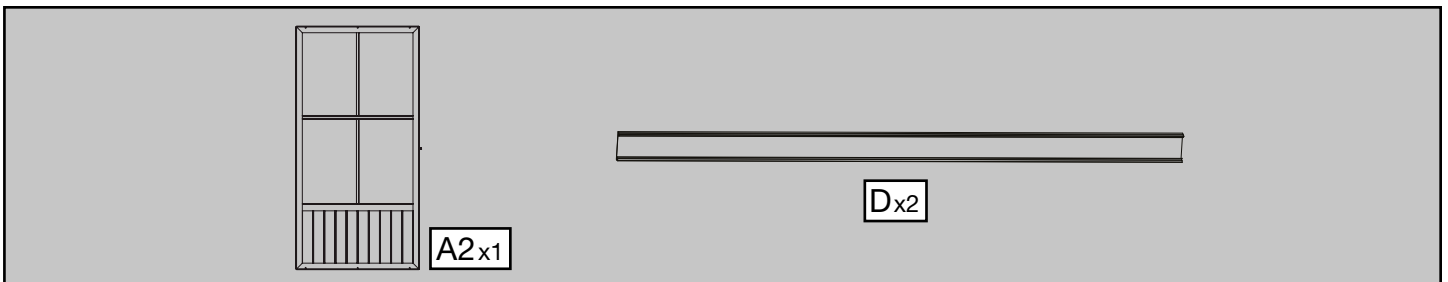
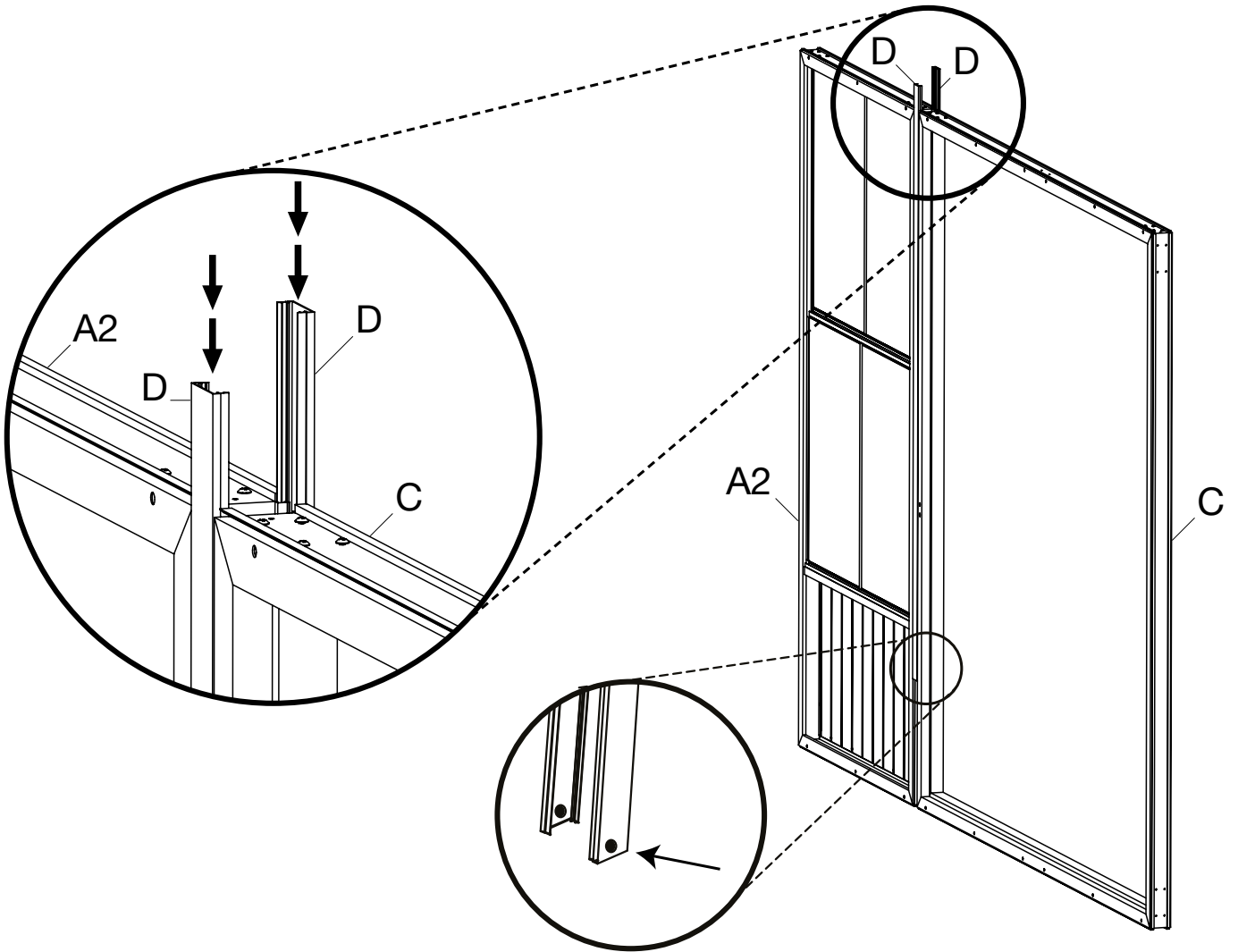

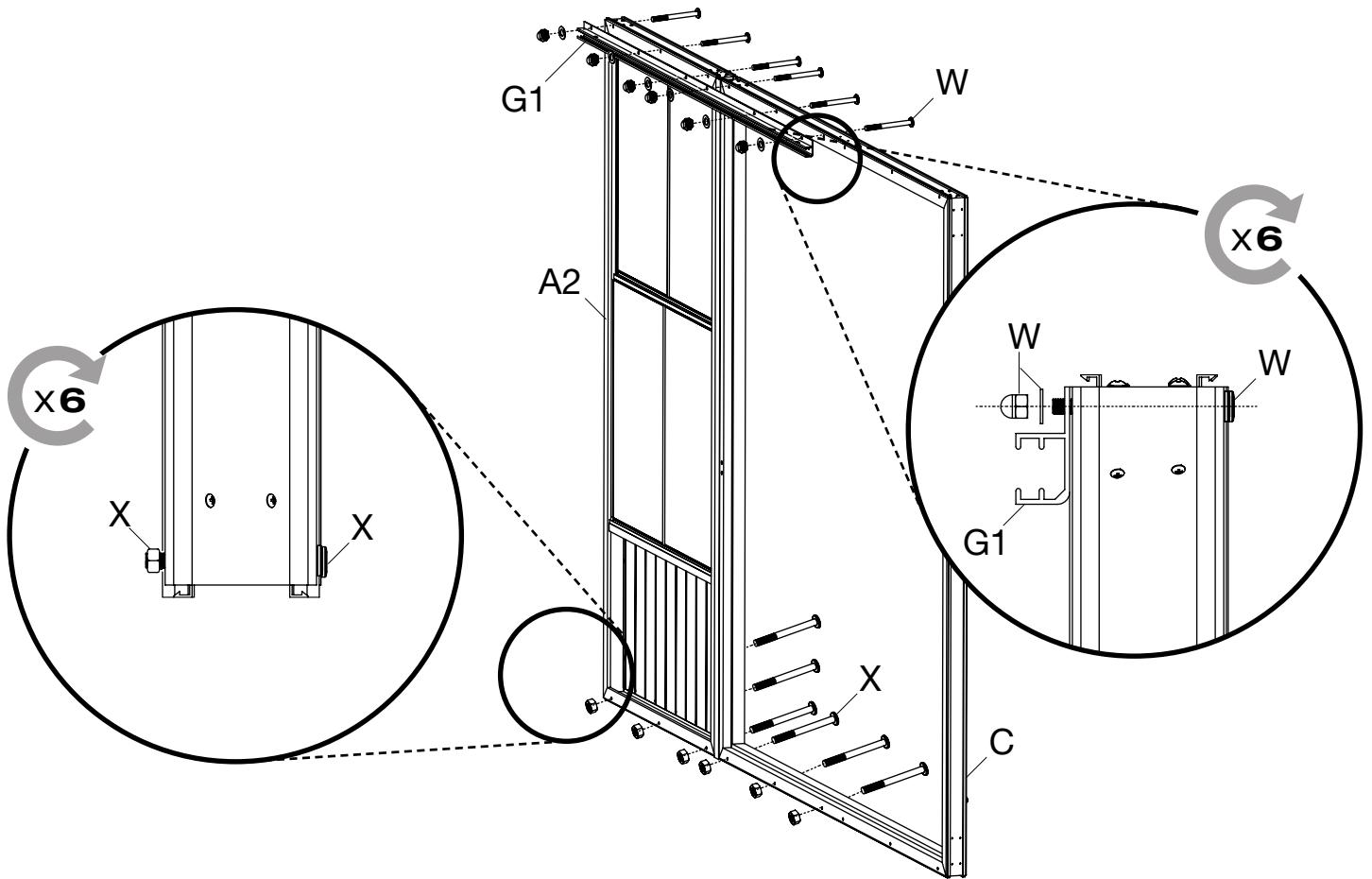

This section contains the parts list and safety instructions for step 10. The parts list includes:

- A long rail labeled G1x1.
- Hardware X, shown as a bolt with a washer and nut, with a quantity of Xx6.
- Hardware W, shown as a bolt with a washer and nut, with a quantity of Wx6.

Two safety icons are present:

- A circular icon with two people silhouettes and the number '2+', indicating that two people are required for this step.
- A circular icon with a hand and a diagonal slash, indicating that no force should be applied during the assembly.

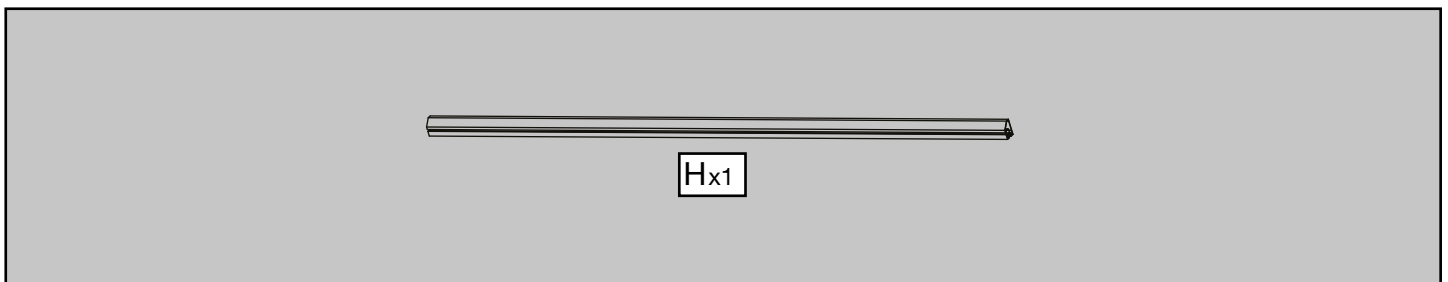
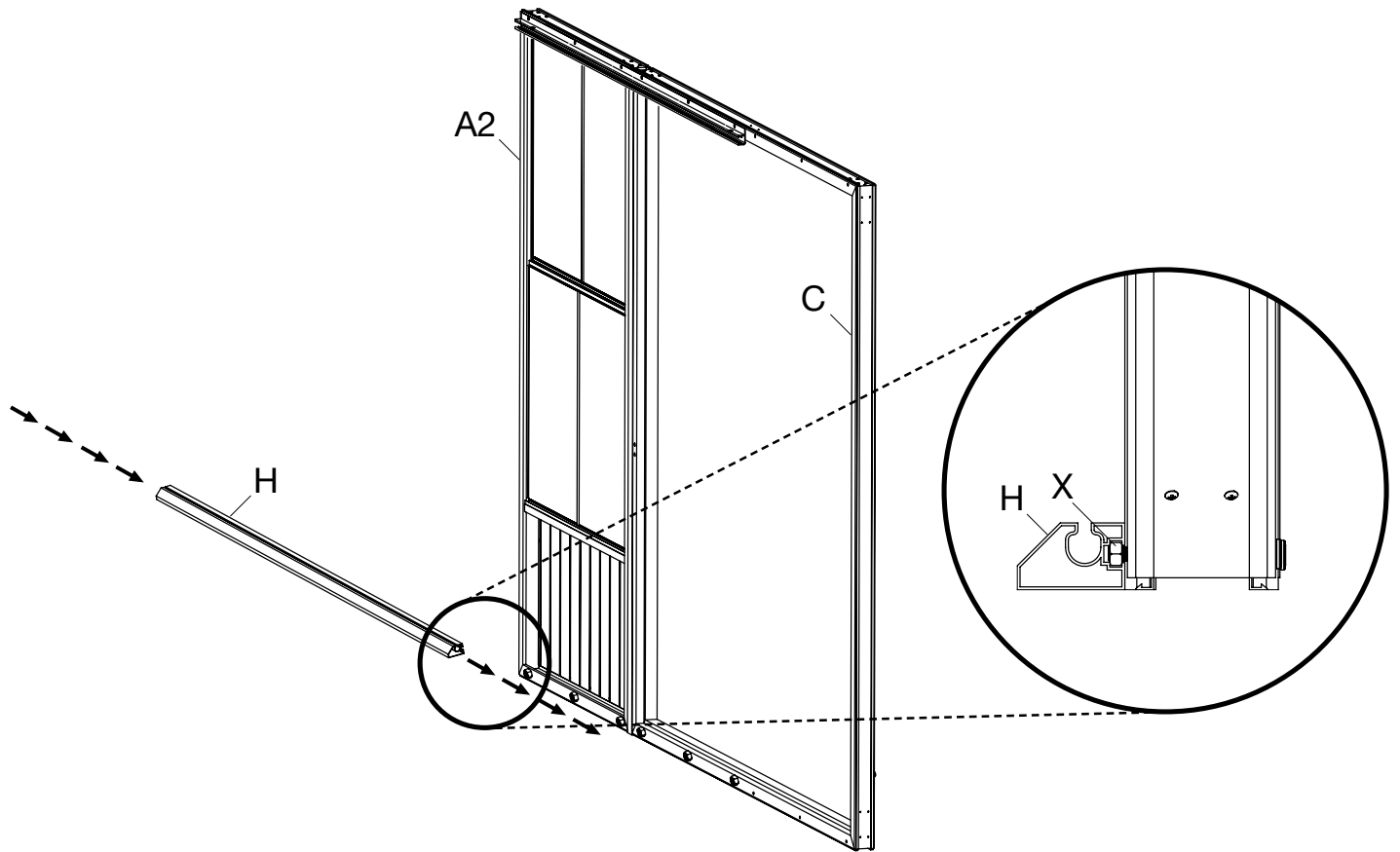

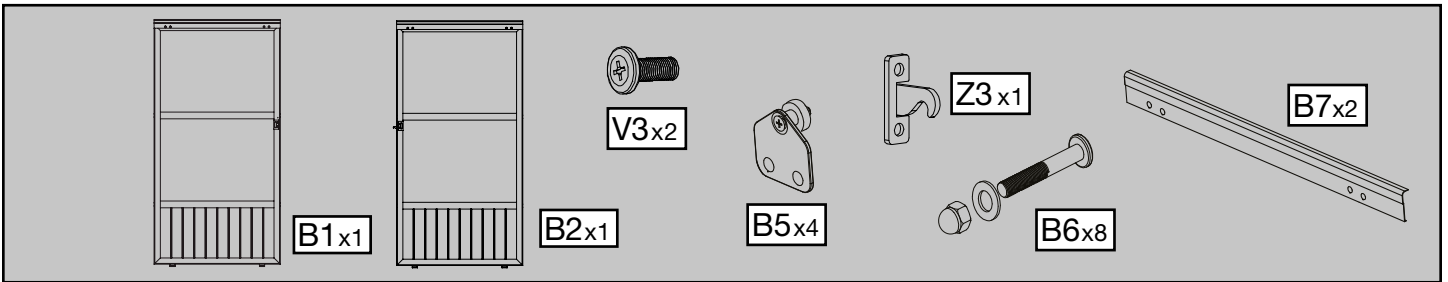
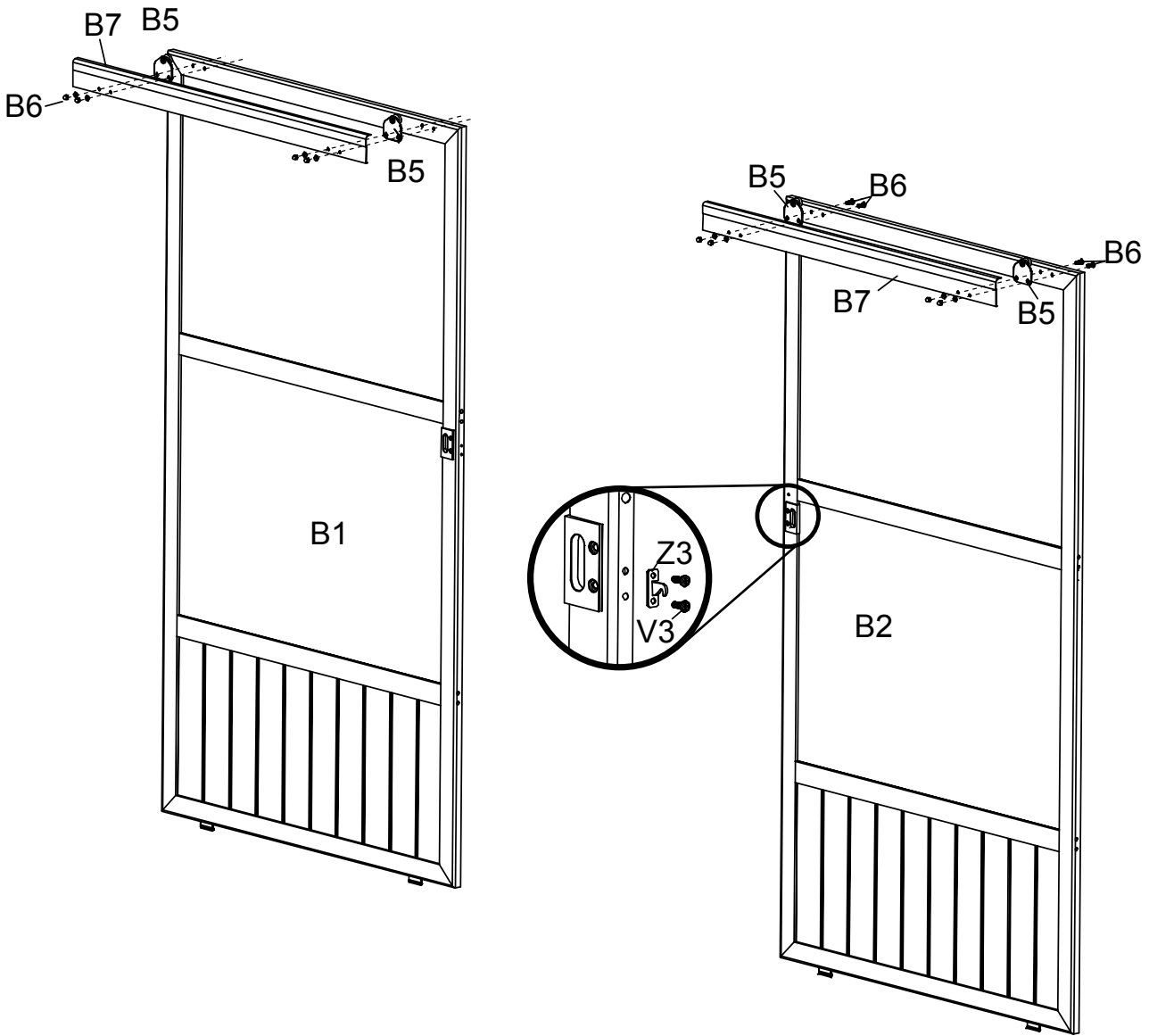

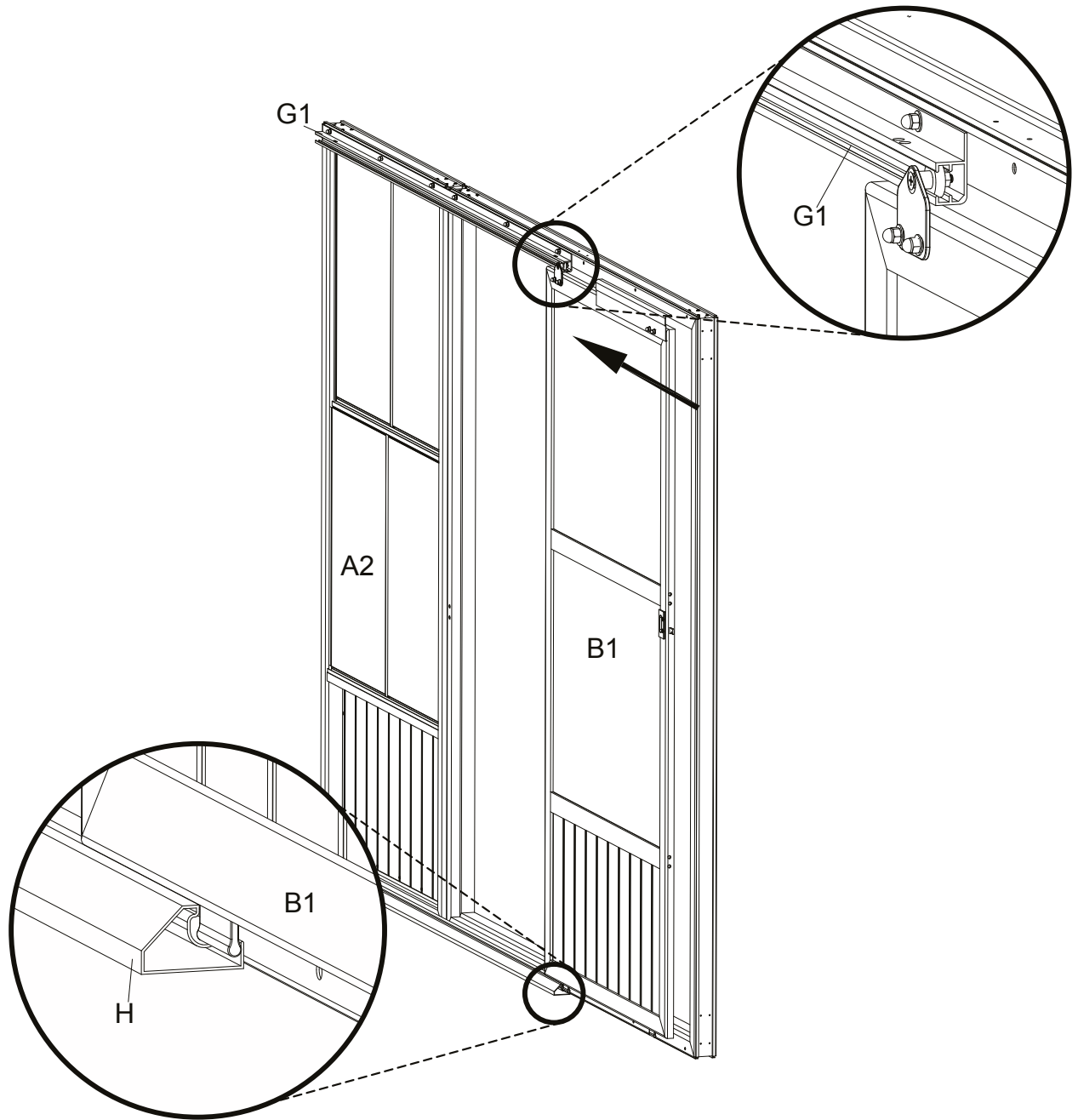

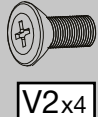
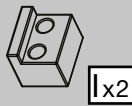
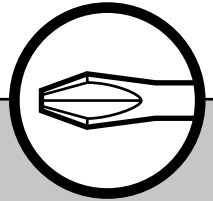
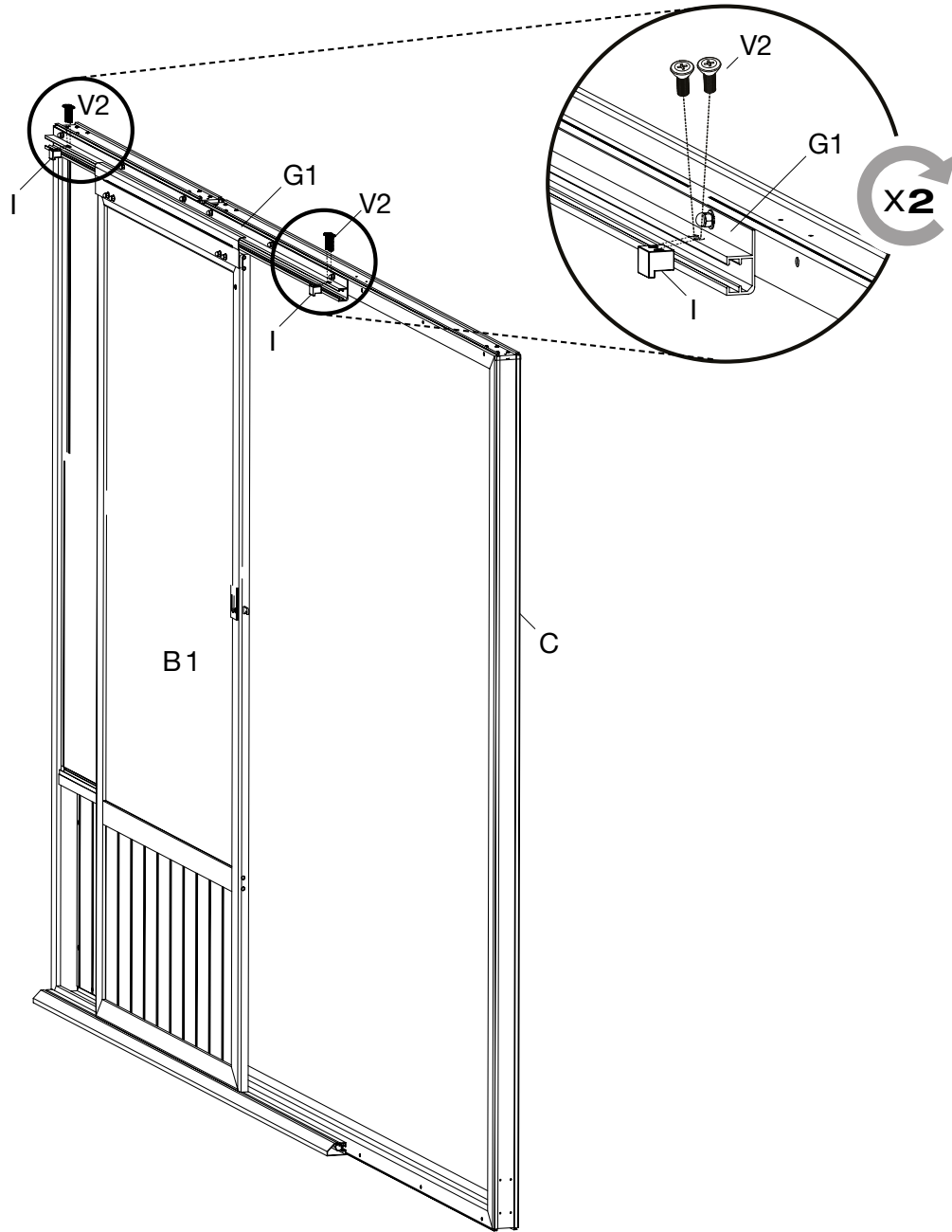

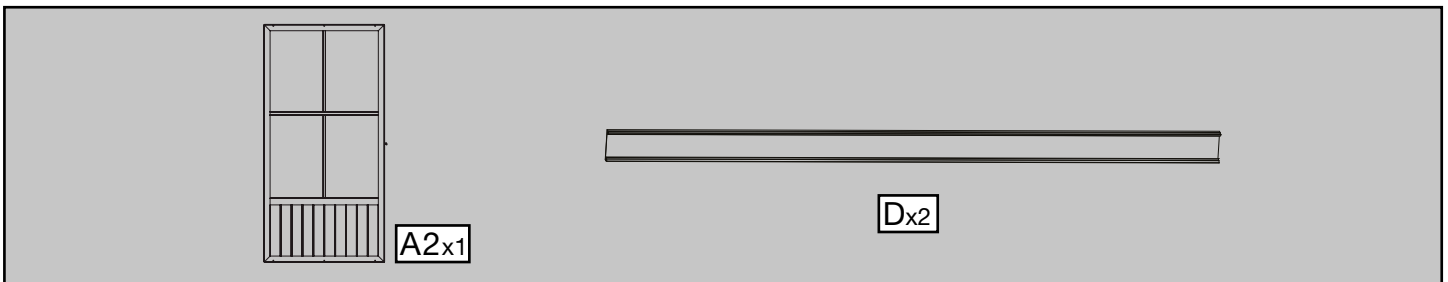
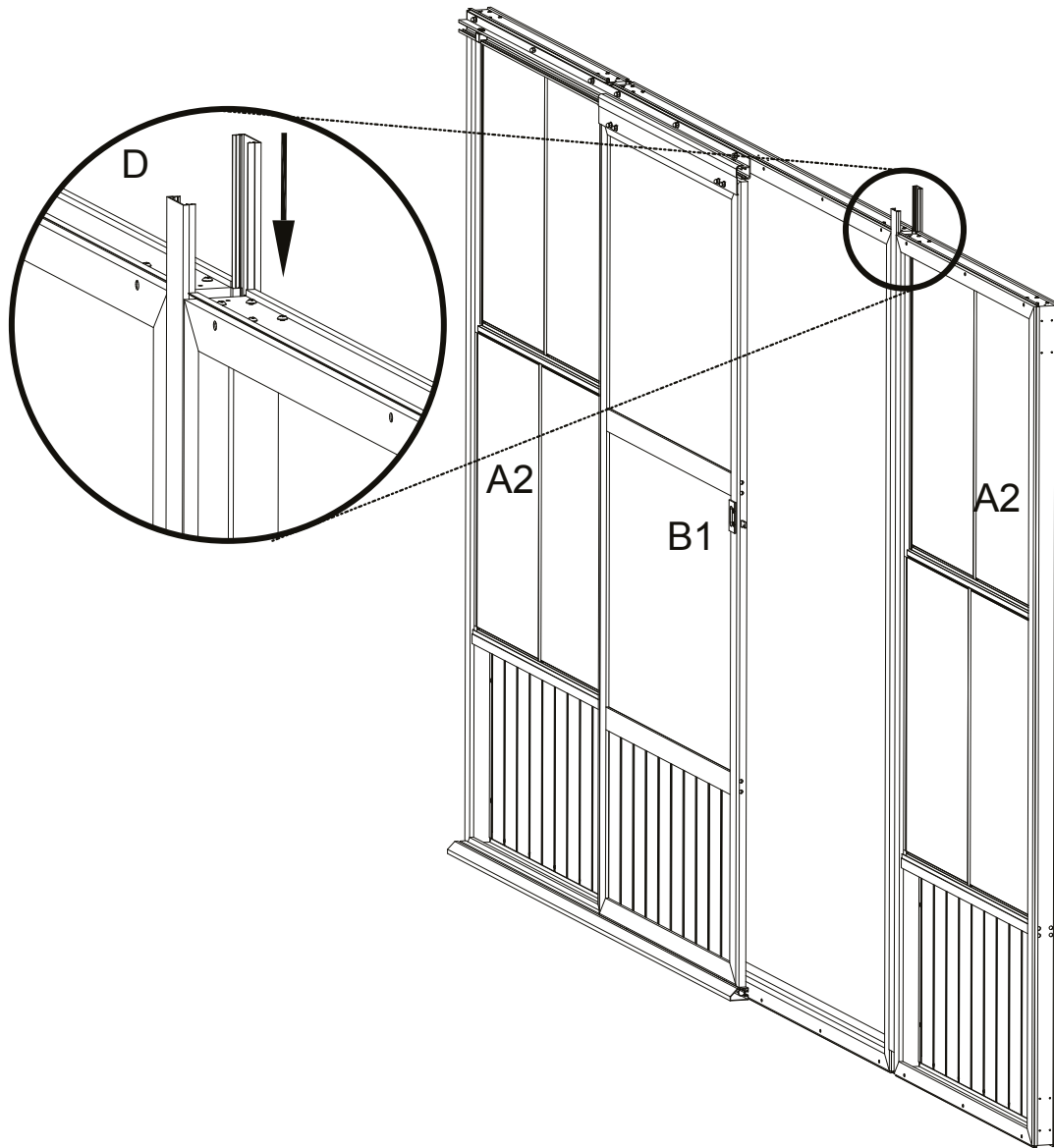

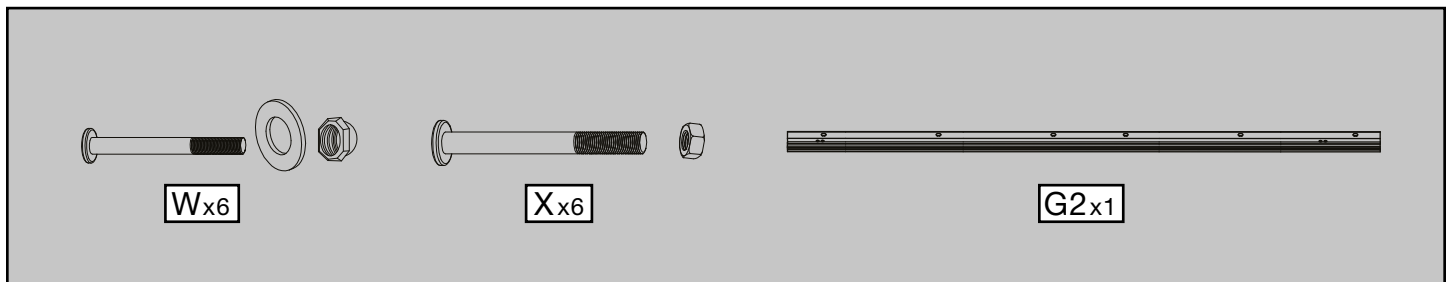
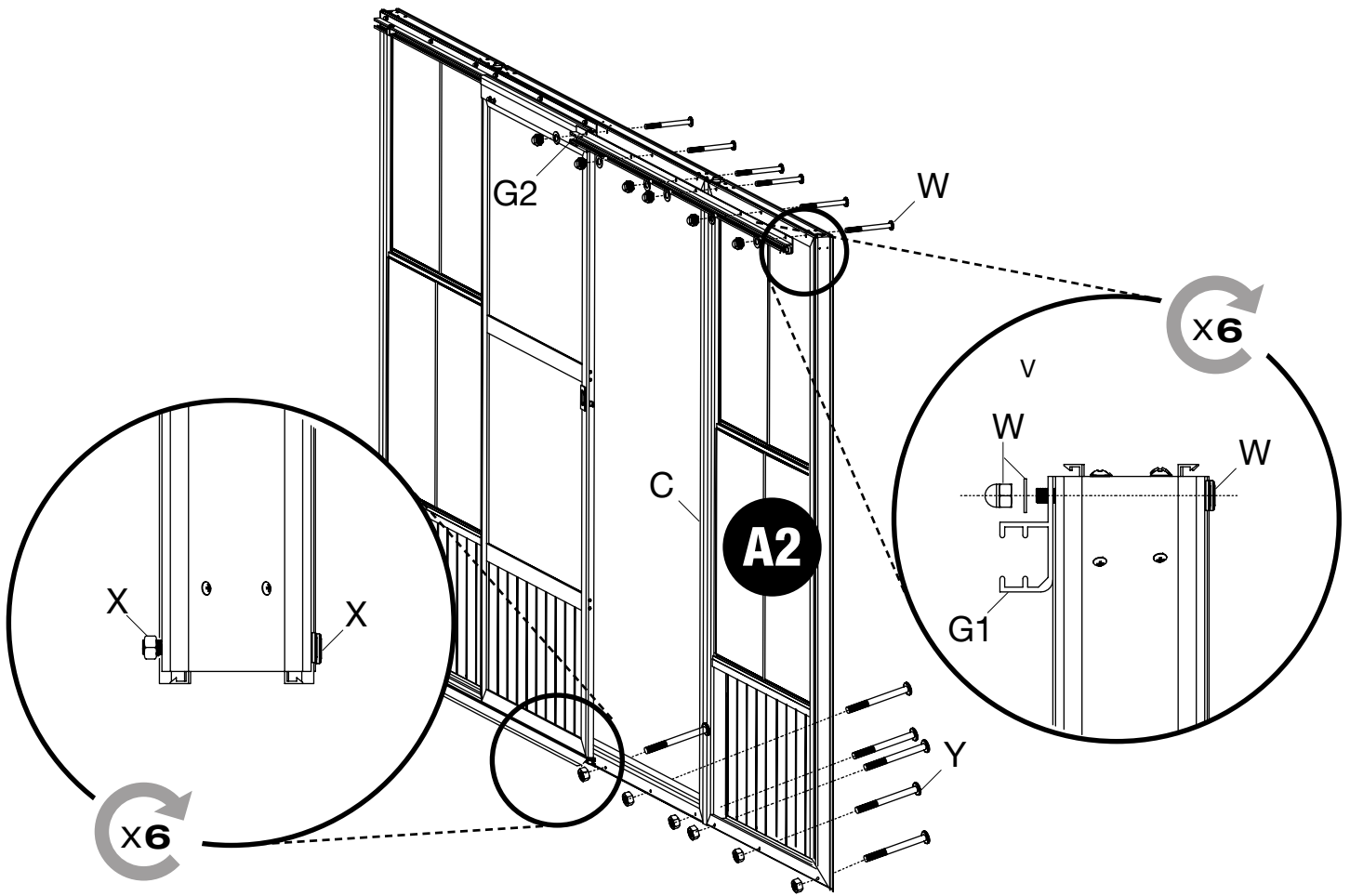

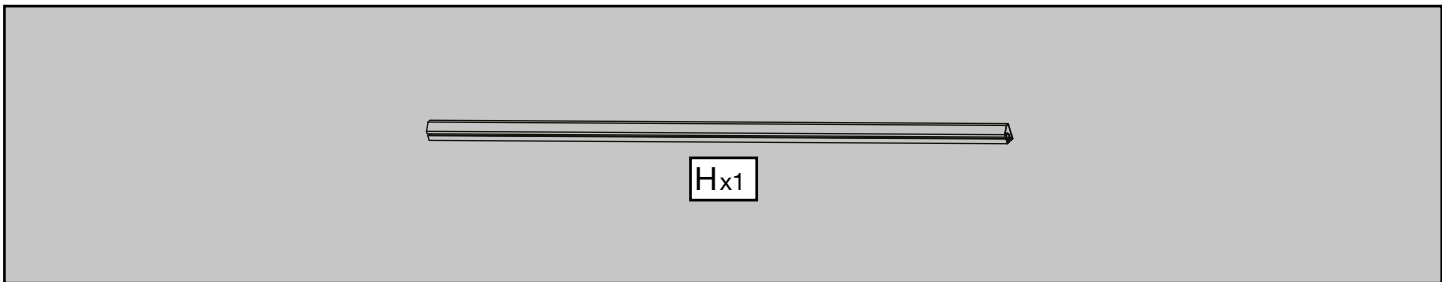
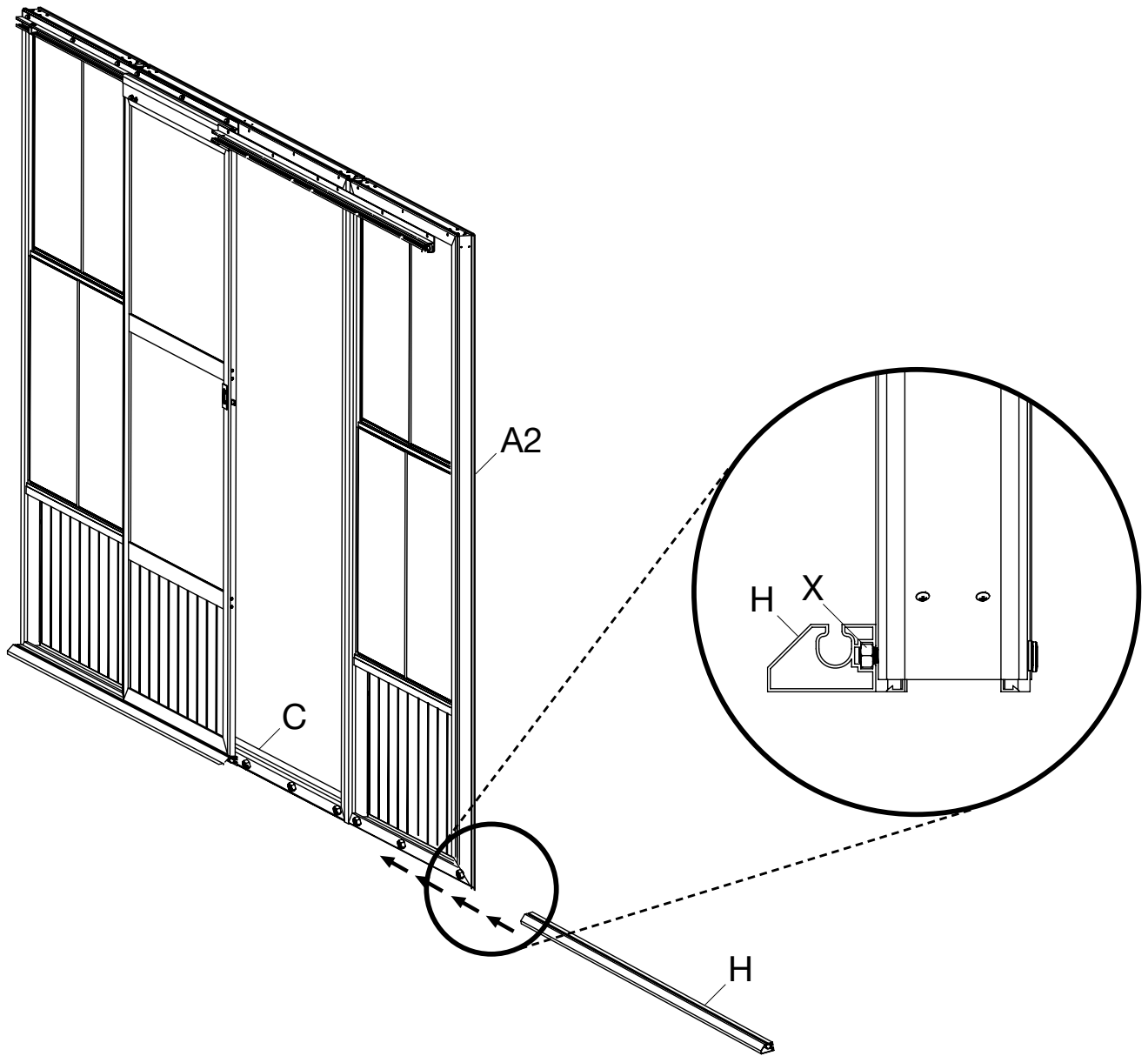

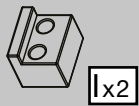
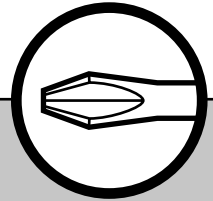
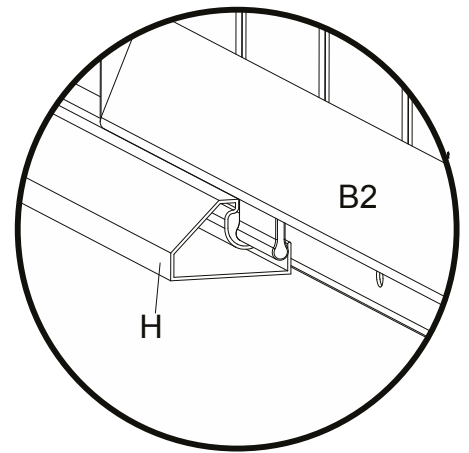
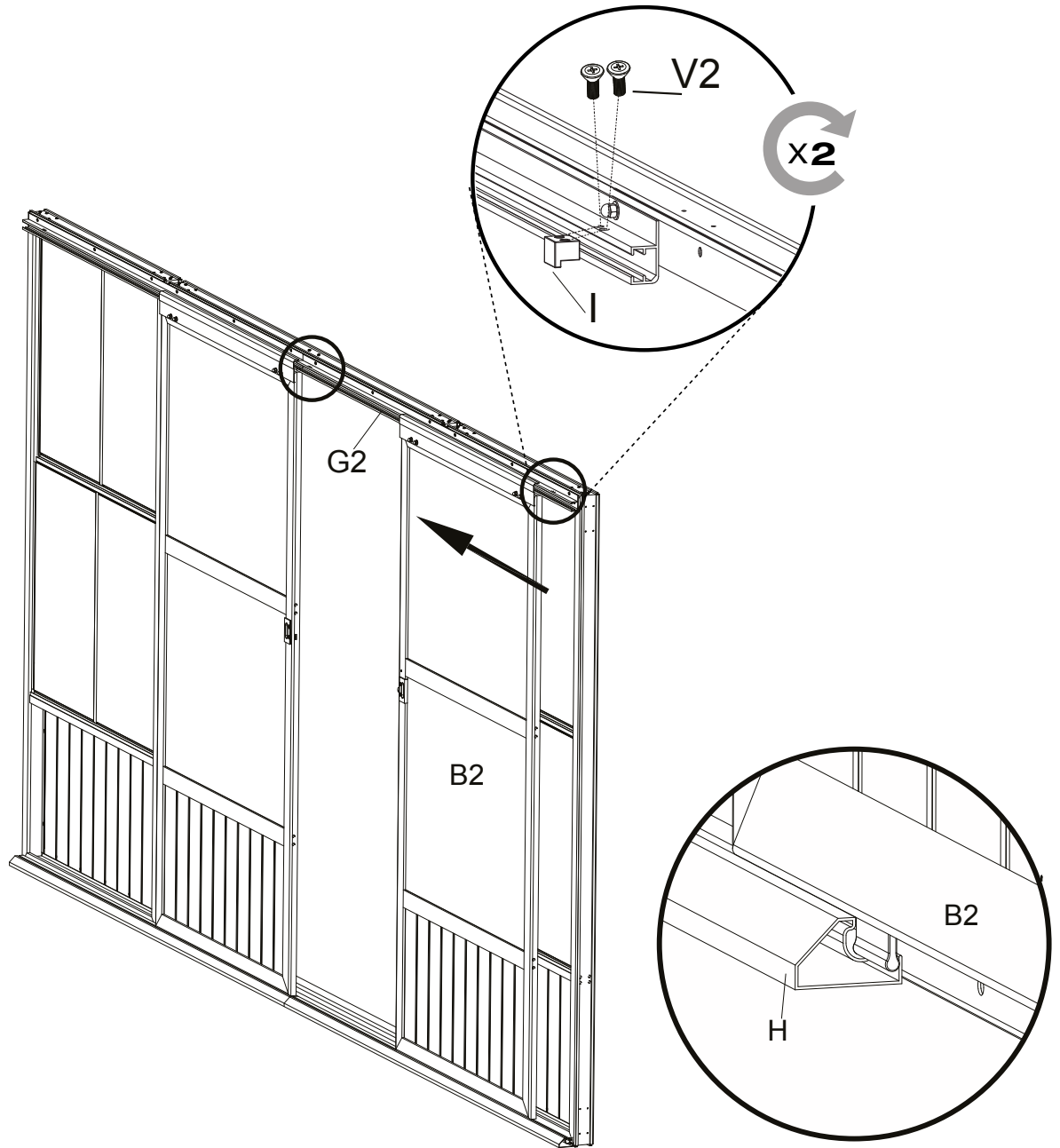

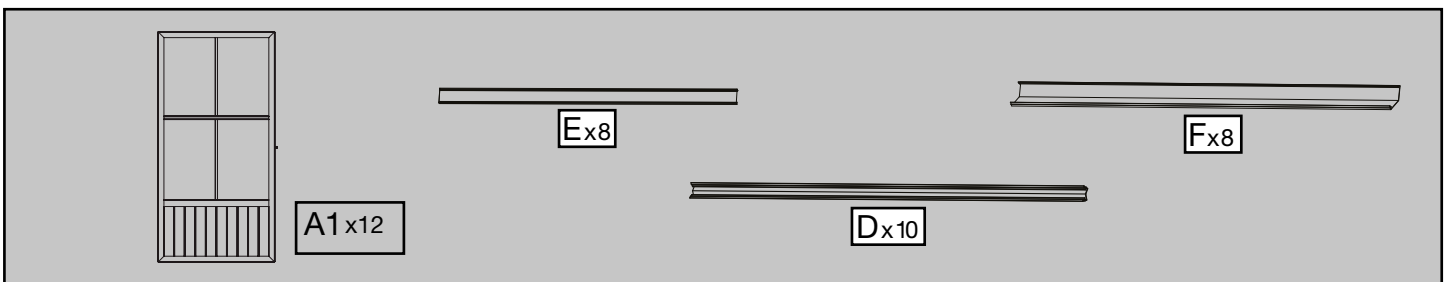
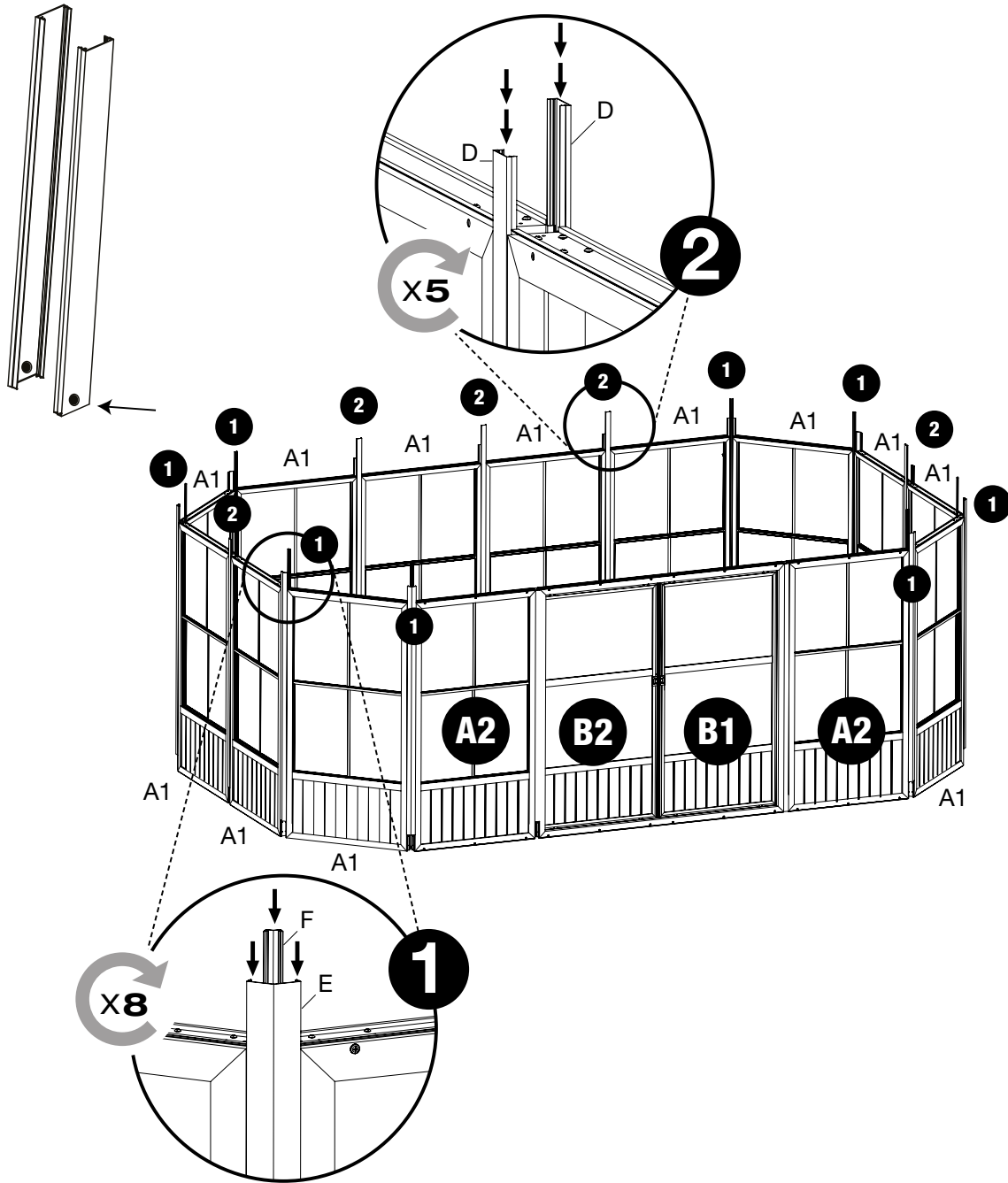

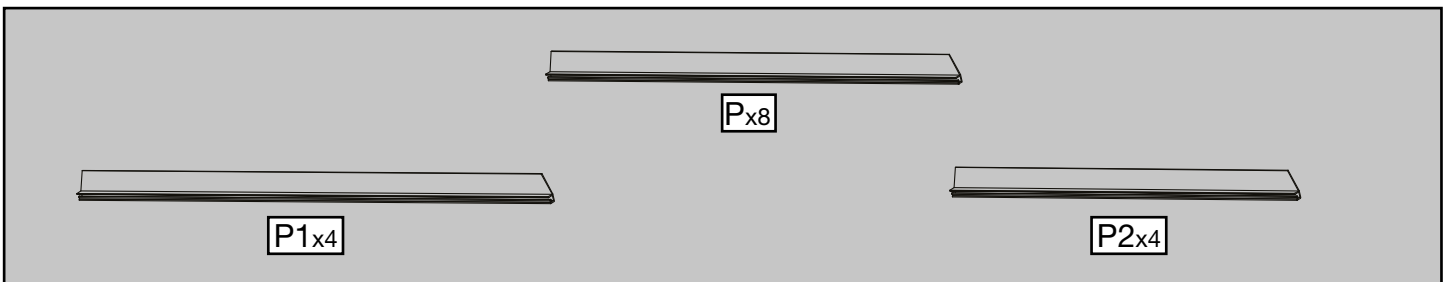
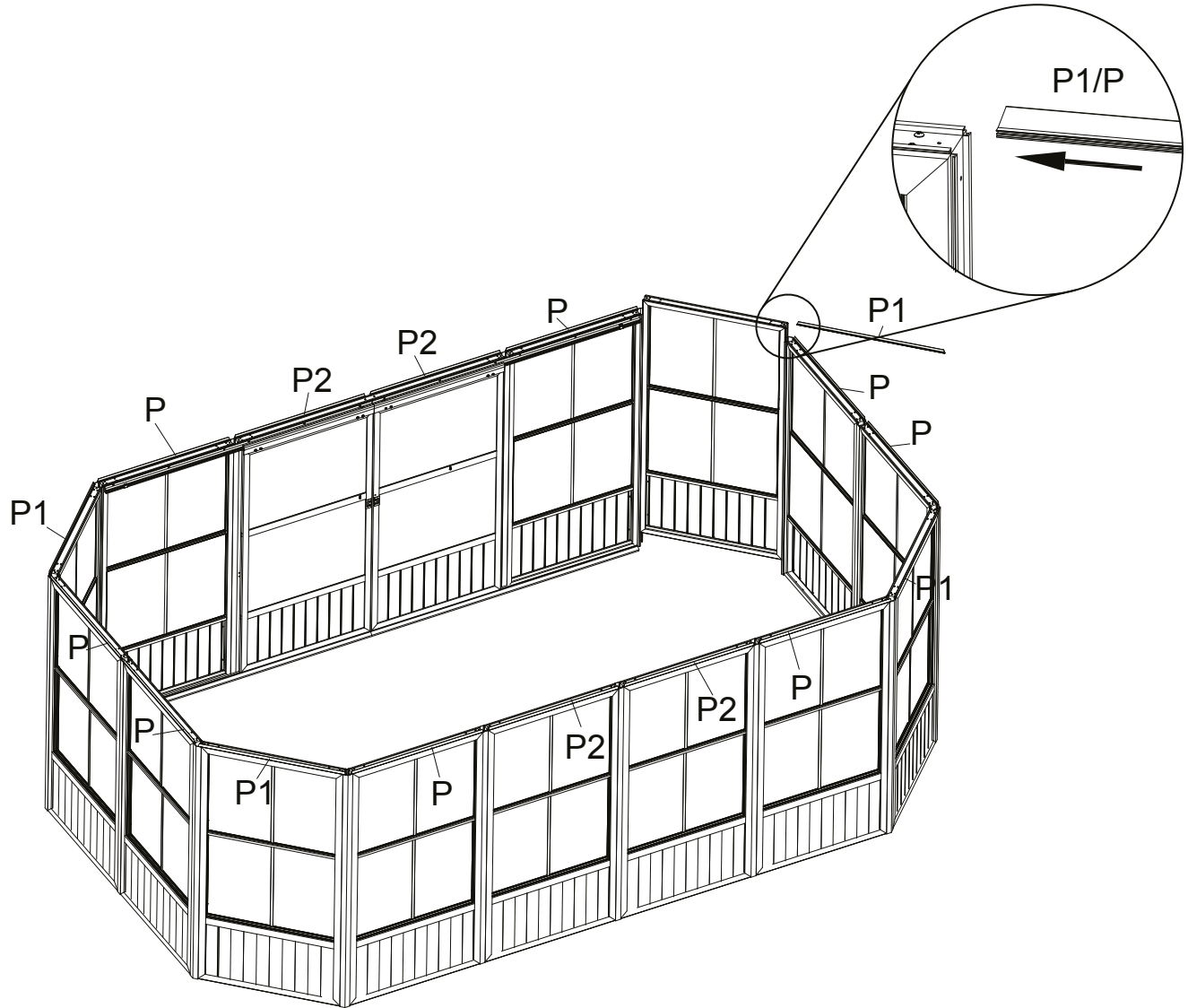

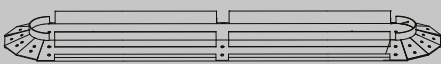
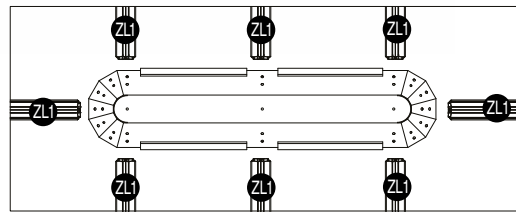
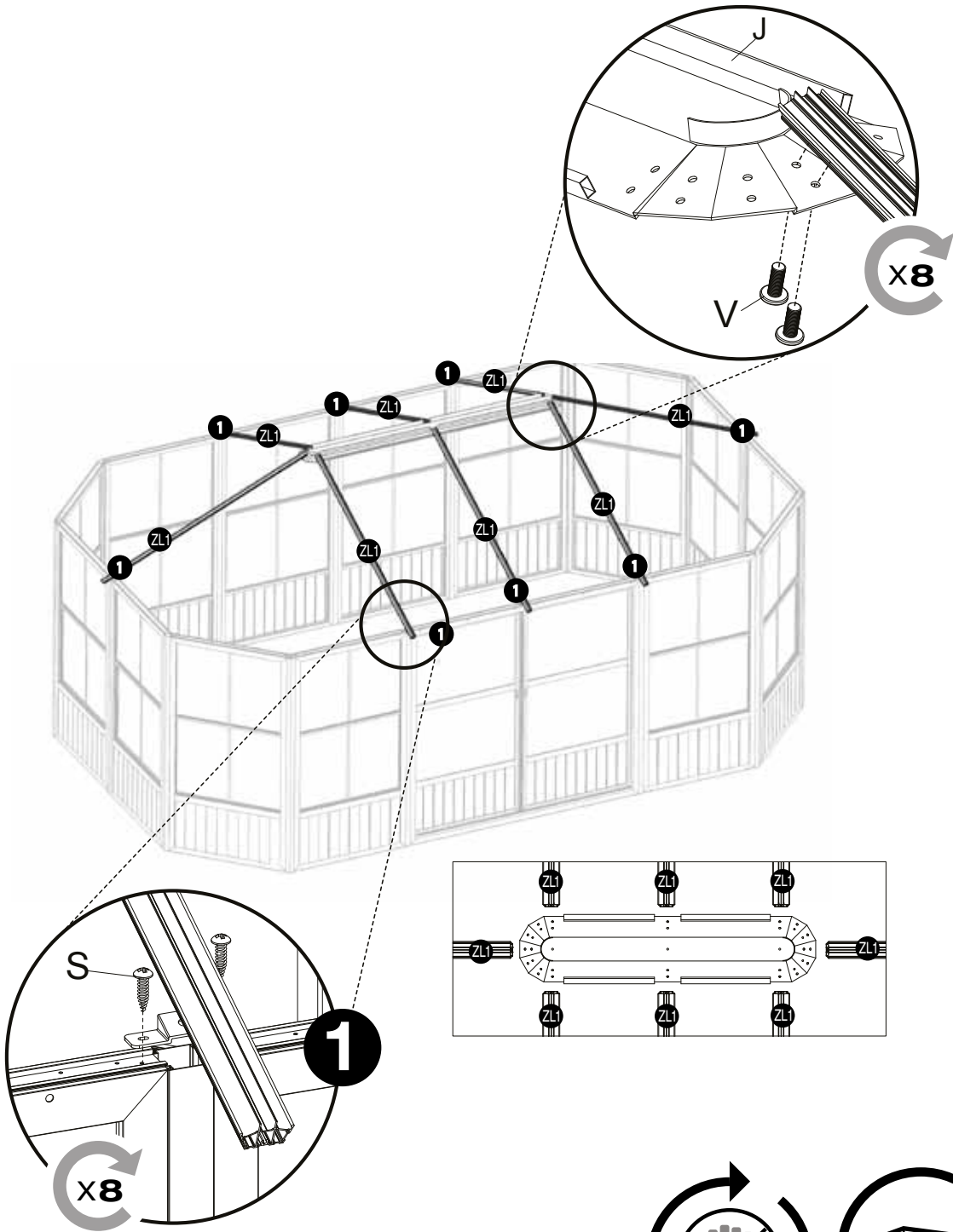

J x1

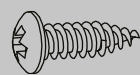

Sx16

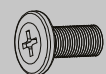

Vx16

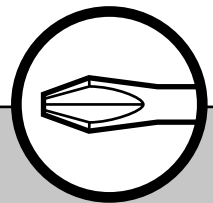
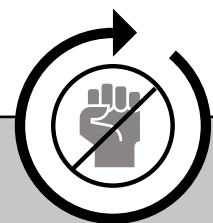

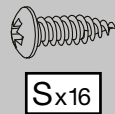
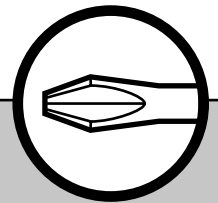
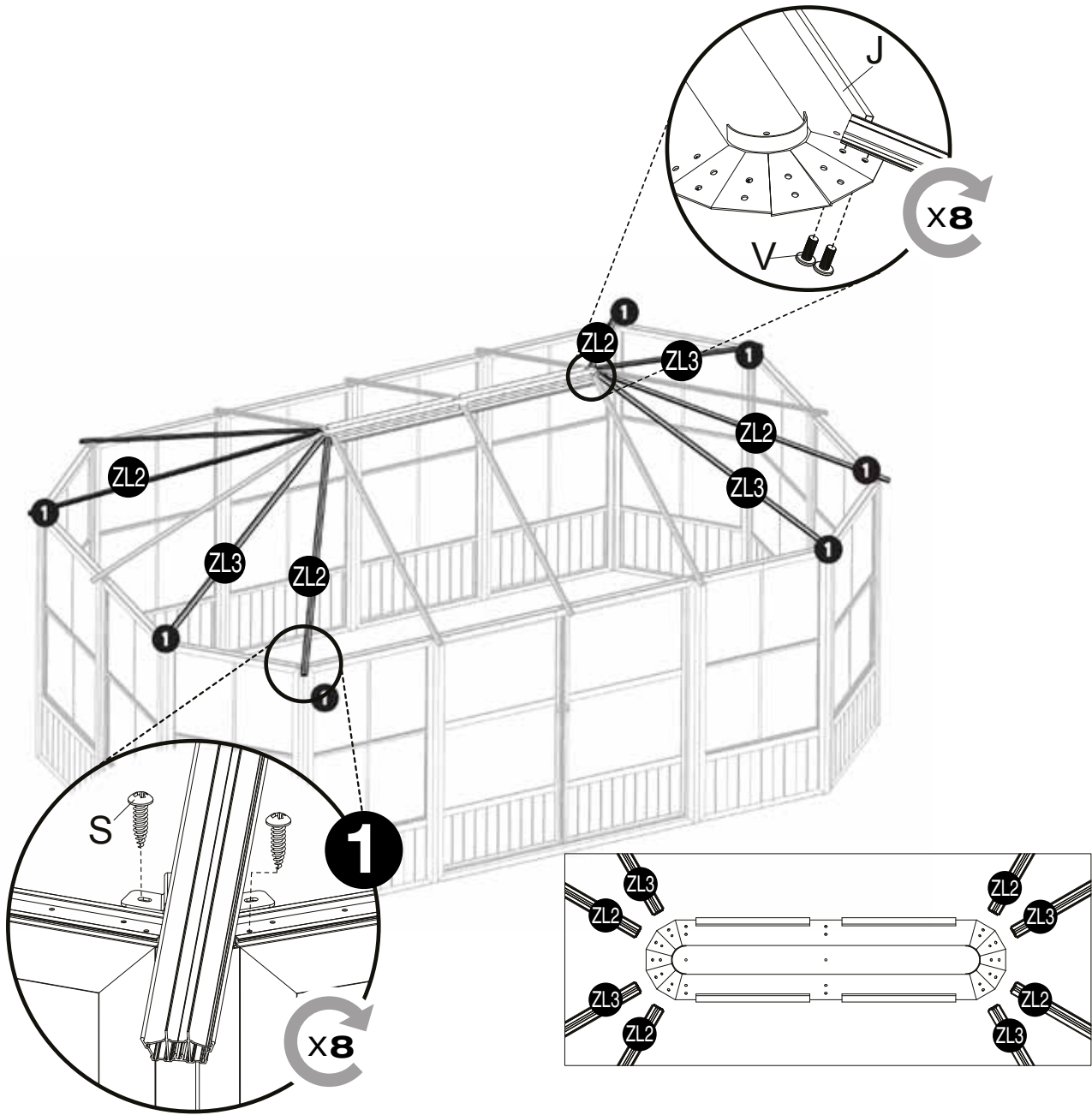

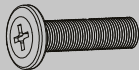
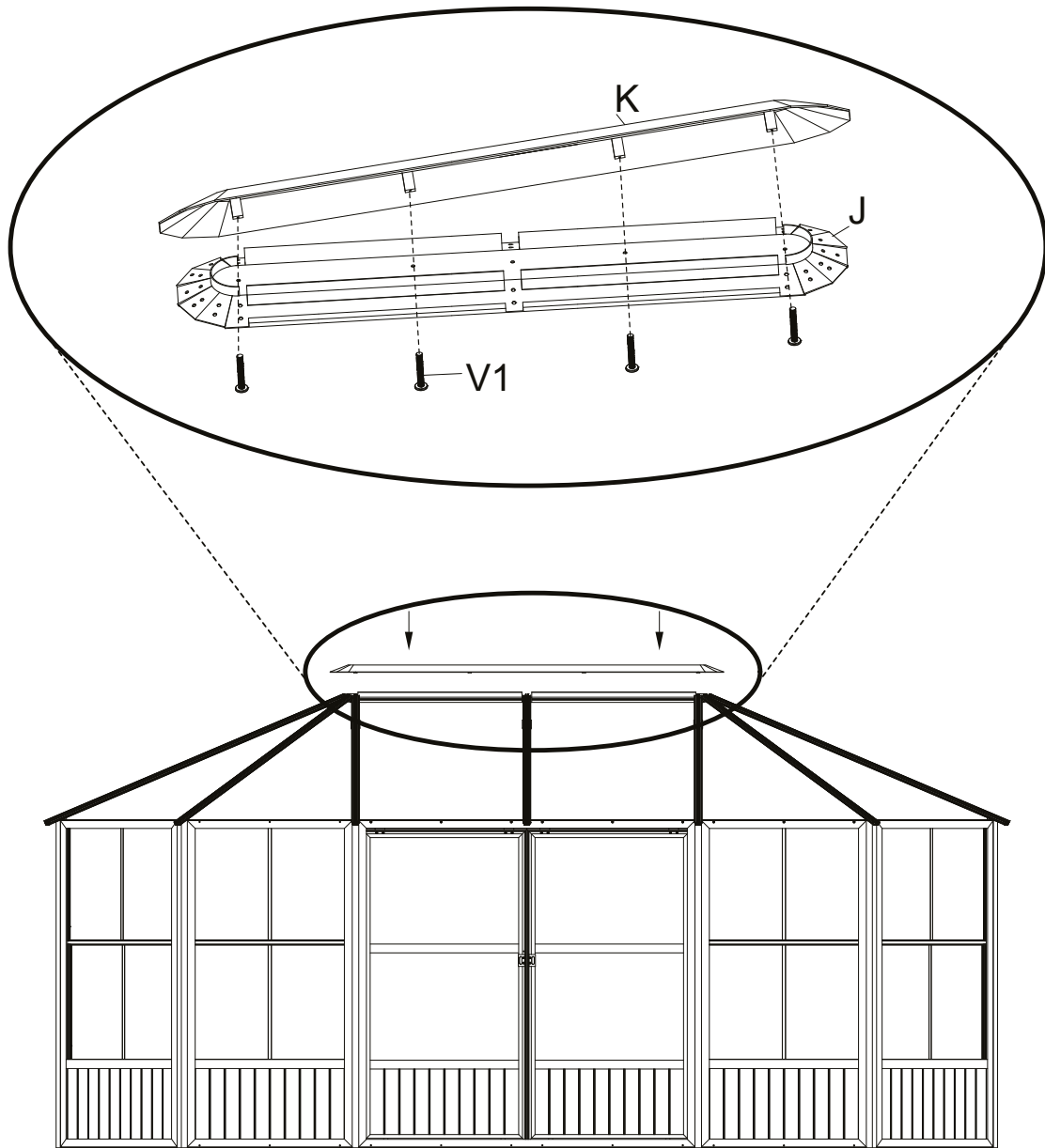

V1x4

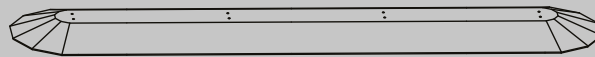

Kx1

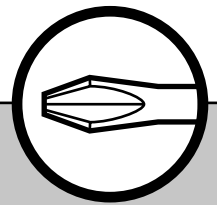

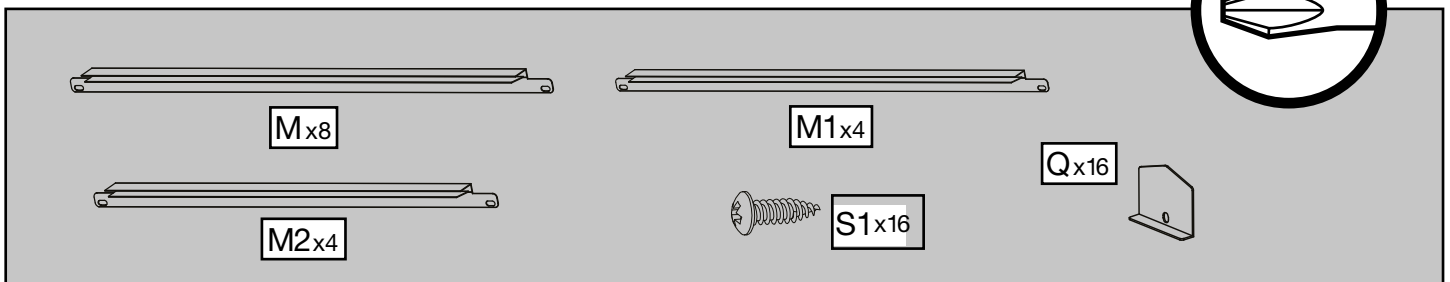
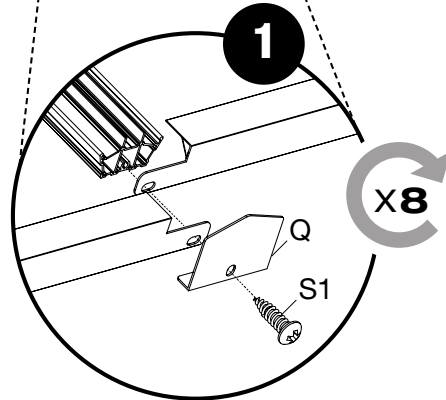
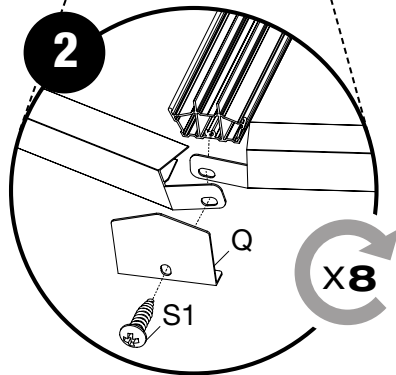
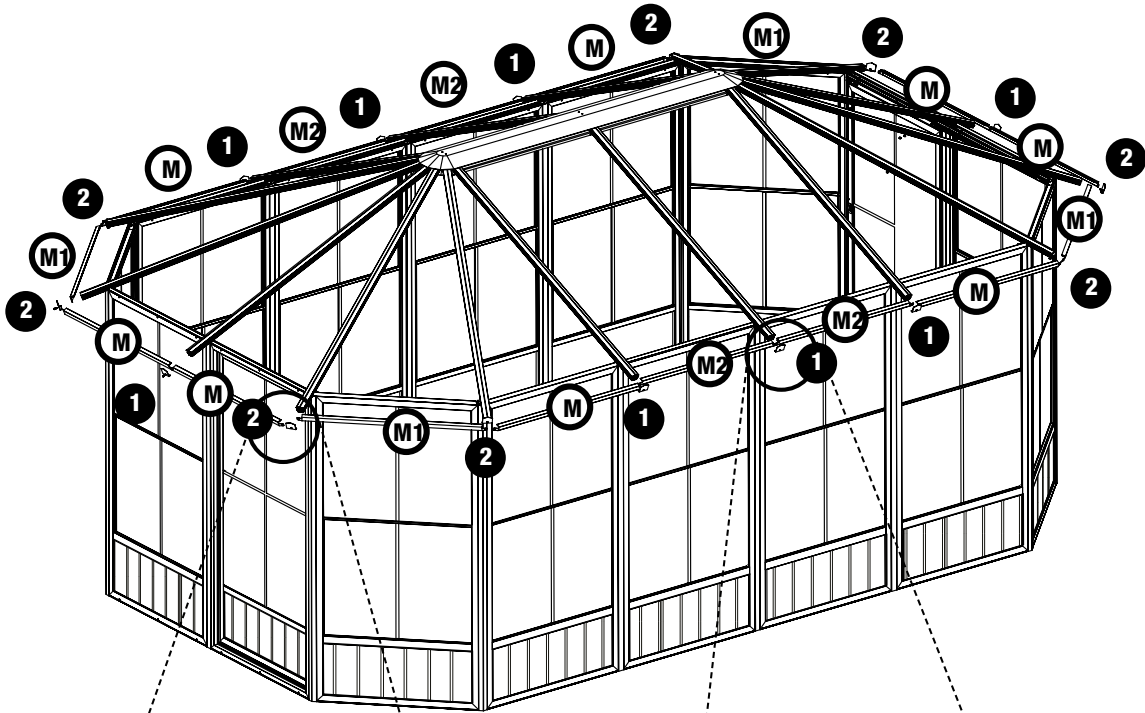
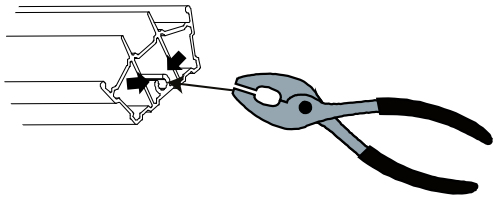

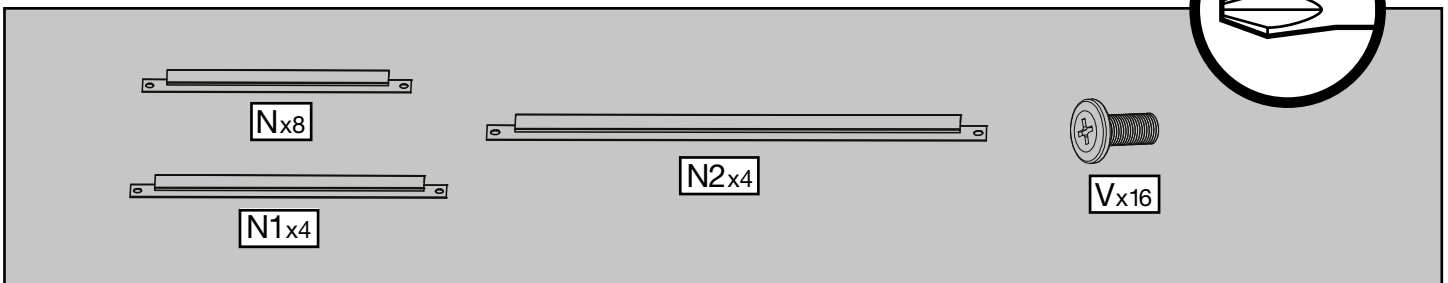
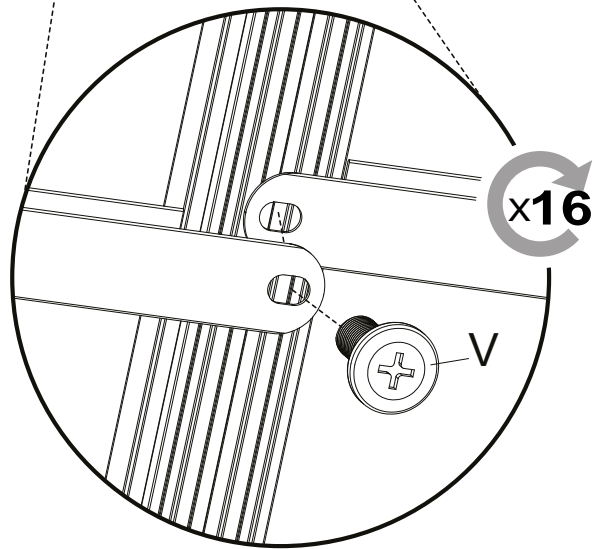
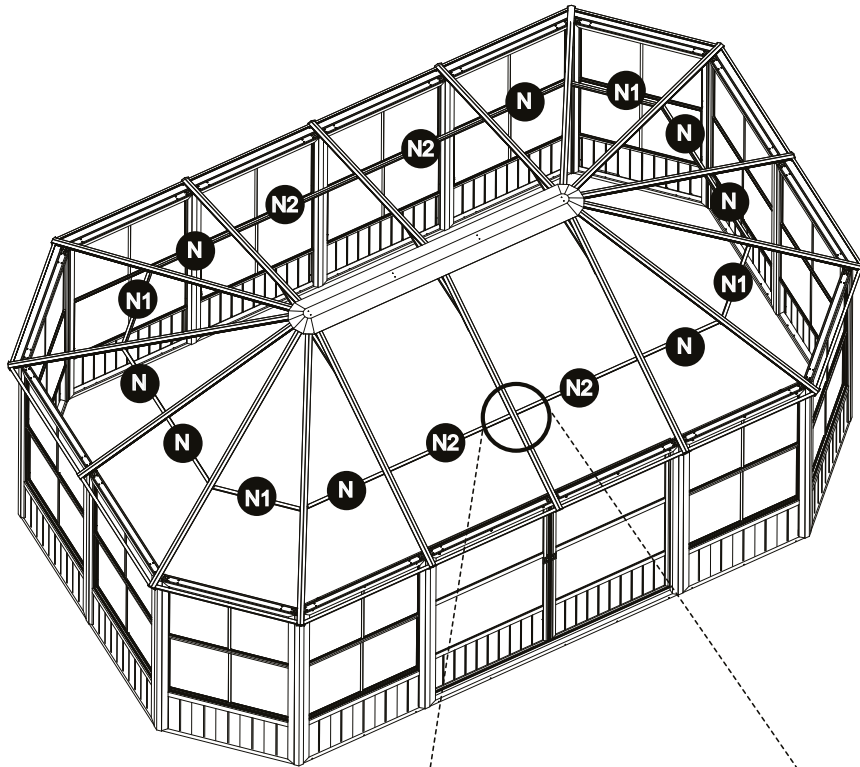

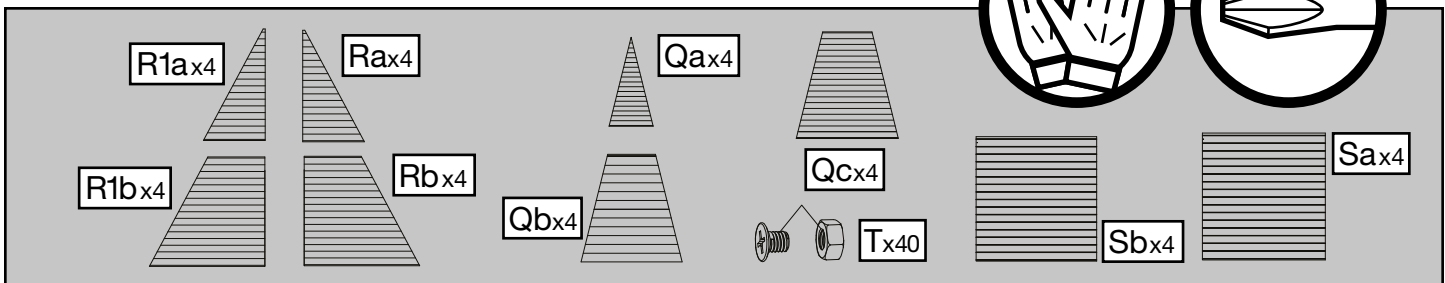
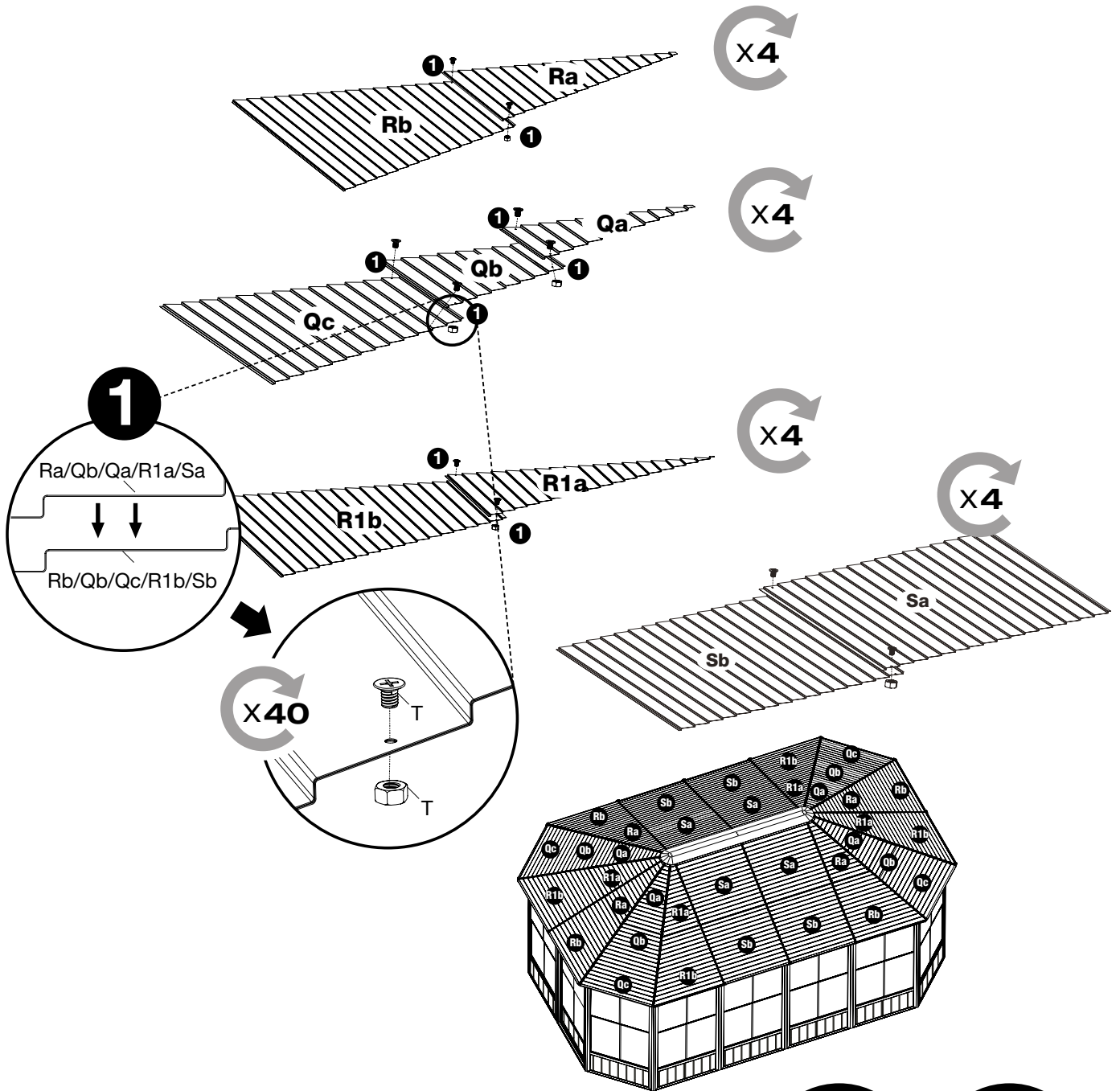

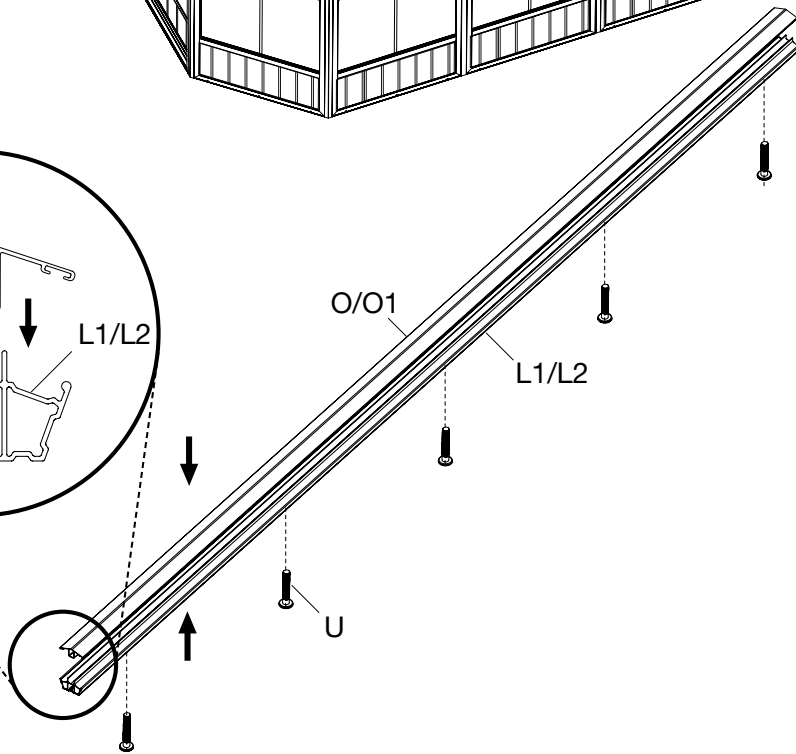
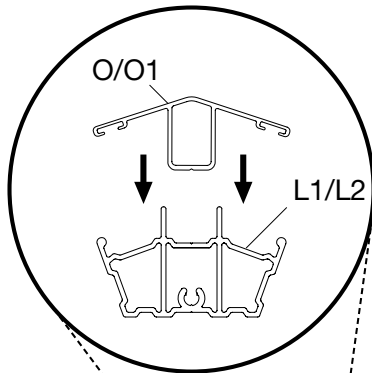
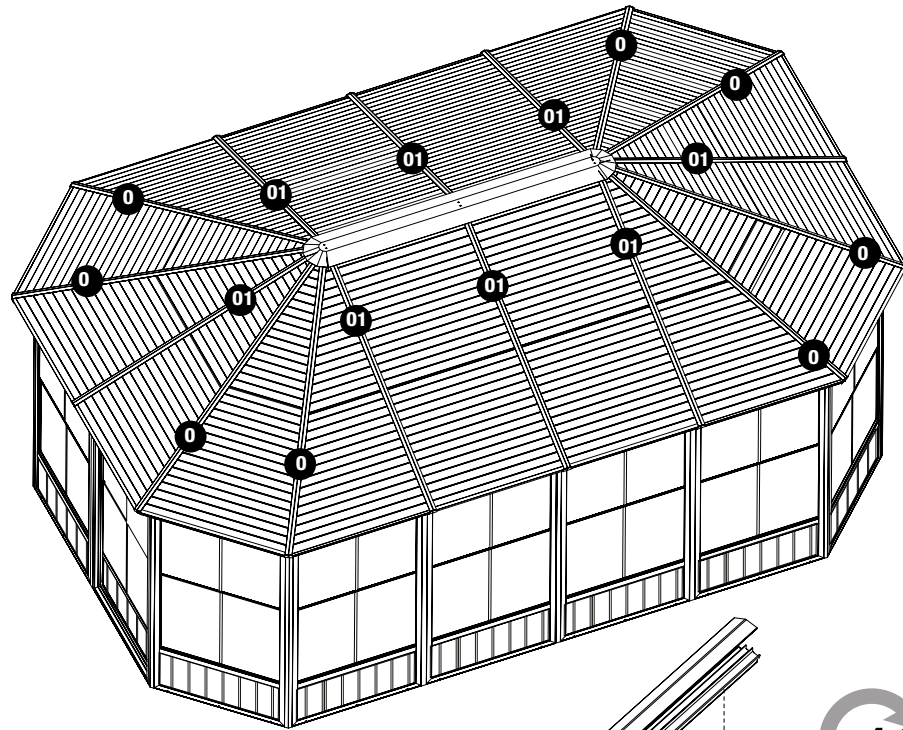

x16

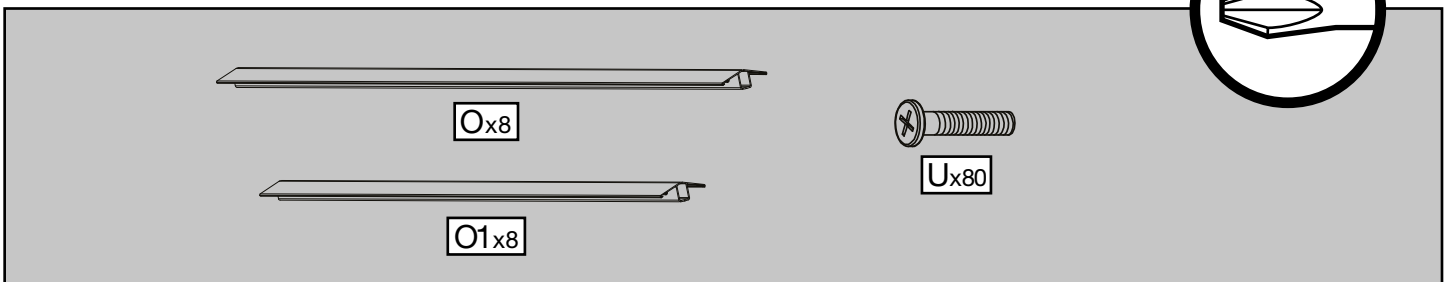

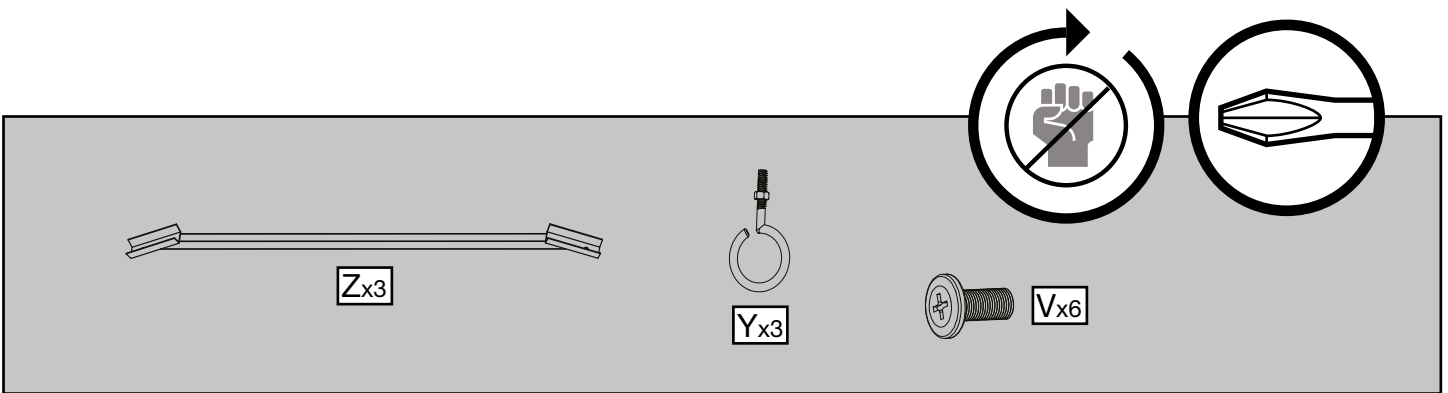
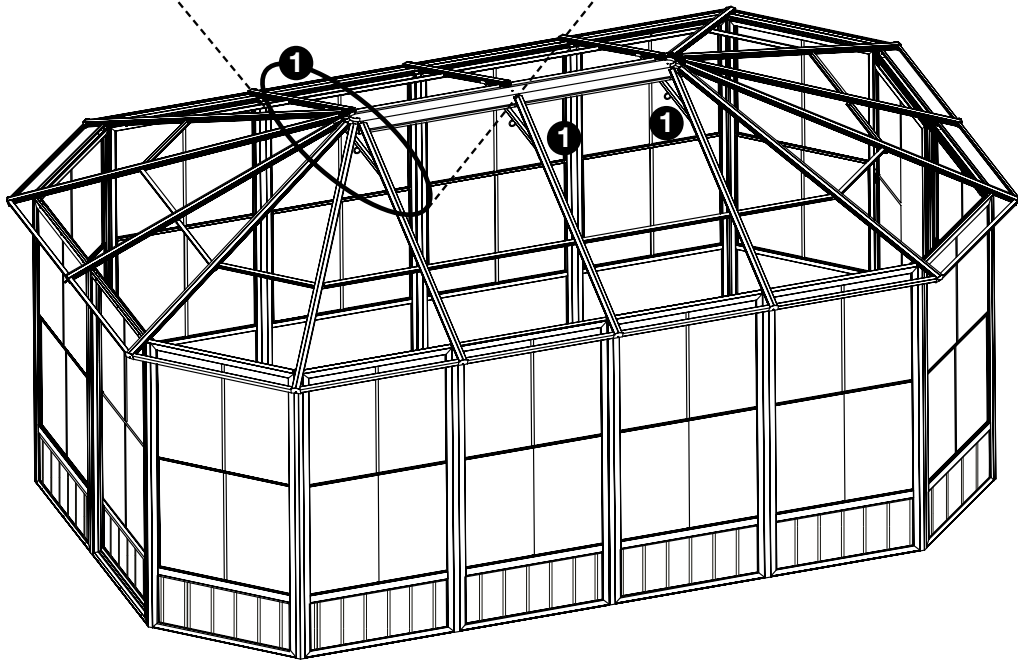
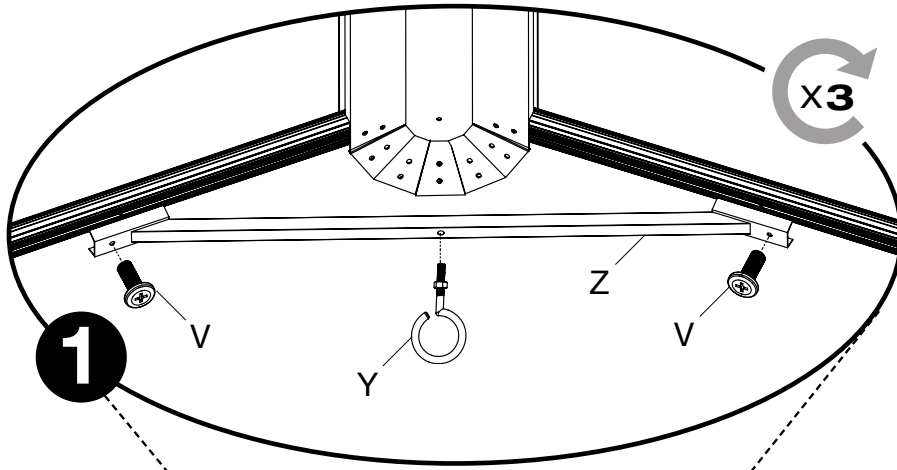

SOJAG ■ I
produits saisonniers • seasonal products