



12x12 SunShed Garden Shed

Revision #31.1
October 4, 2022



Thank you for purchasing an 12x12 SunShed Garden Shed from Outdoor Living Today. Please take the time to identify all the parts prior to assembly.



Safety Points and Other Considerations

Our products are built for use based on proper installation and normal residential use, on level ground. Please follow the instruction manual when building your shed and retain the manual for future maintenance purposes.

Some of the safety and usage measures you may wish to consider include:

- snow load ratings vary by geographical location. If heavy or wet snowfall occurs, it is advisable to sweep the snow off the roof(s).
- if the product is elevated, any structural and building code requirements are solely the customer's responsibility, and should be abided by.
- in high or gusty wind conditions it is advisable to keep the structure securely grounded.
- have a regular maintenance plan to ensure screws, doors, windows and parts are tight.

Customer agrees to hold Outdoor Living Today free of any liability for improper installation, maintenance and repair of any of our products.

In the event of a missing or broken piece, simply call the Outdoor Living Today Customer Support Line @ 1-888-658-1658 within 30 days of the delivery of your purchase. It is our commitment to you to courier replacement parts, free of charge, within 10 business days of this notification. Replacement parts will not be provided free of charge after the 30 day grace period.

What to do before my Shed arrives?



- Become familiar with this assembly manual and determine if you can complete the project yourself or will require a professional contractor.



- One helper is recommended to assist in constructing your shed. It generally takes two people about 3 days to assemble a shed. If you're hiring a contractor, their rate should be in line with that duration of work.



- Clear the construction area and ensure a clear pathway for delivery when the freight company arrives. Remove all debris: roots, grass, rocks, etc.



- Excavate the site. Contact your local utilities company to ensure there are no gas or electric lines buried in the area before digging.

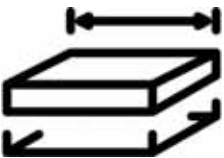

- Decide on the type of foundation you will be using:
 - Concrete slab, or
 - 4-6 inches of crushed gravel with paver stones or 4x4 stringers.

You can find the footprint for your shed on Page 3 of your Assembly Manual.

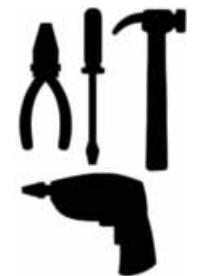

- If doing the assembly yourself, have all the necessary tools ready to go and in working condition. A list of required tools can be found after the parts list.

Foundation Types for 12x12 Garden Shed

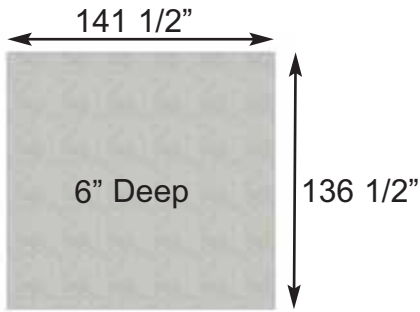

Front Side

Concrete Foundation

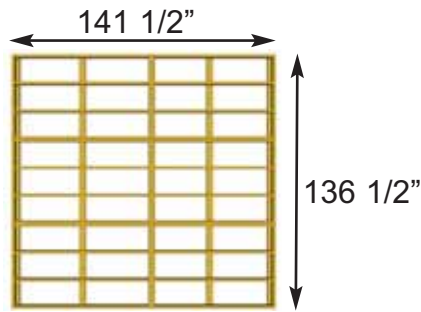

Front Side

Floor Frame

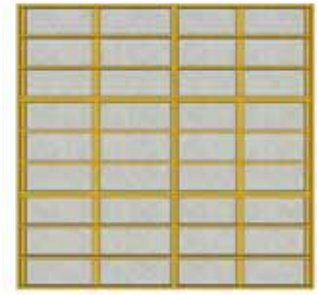

Front Side

Completed Foundation

Concrete Slab Foundation:

- Slab must be at least the same size as assembled floor frame (141 1/2" x 136 1/2") or larger.
- 6" Deep foundation.
- 2.5 Cubic Yards of concrete required.
- A concrete slab will have the longest durability out of your foundation options.

Once level, a concrete slab is the easiest surface to build on.

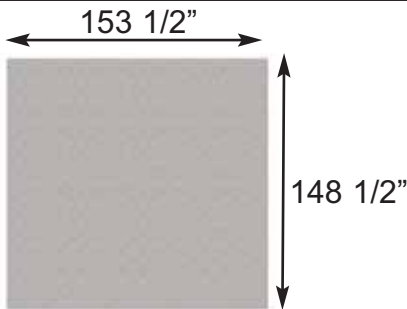

Front Side

Gravel Foundation

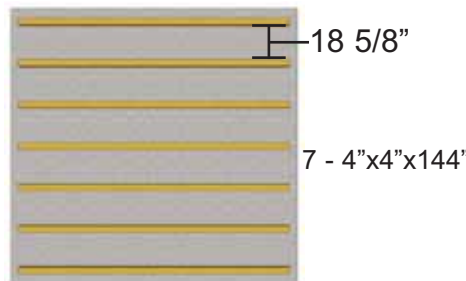

Front Side

Gravel Foundation with treated stringers

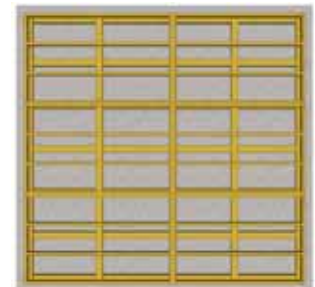

Front Side

Completed Foundation

Gravel with 4x4 Pressure Treated Stringers:

- Excavate at least 6" deep, and 6" wider than floor frame on each side.
- 3.0 Cubic Yards of gravel required, approximately 27 wheelbarrows.
- 7 - 4x4 Pressure Treated Stringers 12' long required.
- Evenly spaced, with one at each end of floor frame.

Saves money on materials, easy to level and work with.

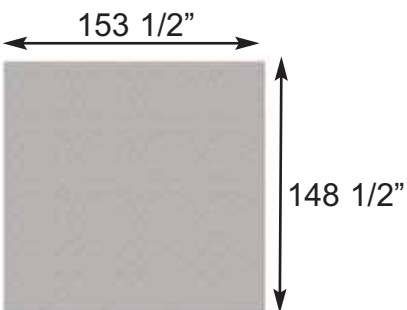

Front Side

Gravel Foundation



Front Side

Gravel Foundation with Patio Pavers

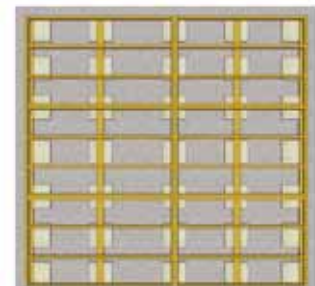

Front Side

Completed Foundation

Gravel with Patio Paver Stones:

- Excavate at least 6" deep, and 6" wider than floor frame on each side.
- 3.0 Cubic Yards of gravel required, approximately 27 wheelbarrows.
- 35 patio pavers (8" x 8" or larger).
- Center patio paver stones underneath floor runners and underneath seams in floor joists.

Patio paver stones are widely available from most landscape stores.

**Thank you for purchasing our 12x12 Sunshed Garden Shed.
Please take the time to identify all the parts prior to assembly.**

A. Floor Section

- 3 - 45 1/2" x 75" - Floor Joist Frames (Interior Joist Unattached)
- 3 - 45 1/2" x 66 1/2" - Floor Joist Frames (Interior Joists Unattached)
- 6 - 1 1/2" x 3 1/2" x 71 7/8" - Floor Joists
- 6 - 1 1/2" x 3 1/2" x 63 1/2" - Floor Joists
- 3 - 45 3/8" x 74 7/8" - Floor Plywood
- 3 - 45 3/8" x 66 3/8" - Floor Plywood
- 10 - 1 1/2" x 3 1/2" x 76 1/2" & 60" - Floor Runners

B. Wall Section

Main Wall Panels

- 4 - 45 1/2" x 75" - Solid Wall Panels
- 4 - 1 1/2" x 2 1/2" x 45 1/2" - Bottom Wall Plates
- 4 - 45 1/2" x 75" - Window Wall Panels
- 3 - 45 1/2" x 75" - Double Window Walls
- 1 - 12" x 73" - Narrow Wall Panel
- 2 - 45 1/2" x 9" - Wall Extensors
- 2 - 46 1/4" x 9" - Angled Left Wall Extensors
- 2 - 46 1/4" x 9" - Angled Right Wall Extensors

Window Inserts

- 6 Small Window Inserts
- 4 Regular Window Inserts

Door, Door Jamb, Header & Door Stops

- 1 - 1 1/2" x 3" x 73" - Vertical Door Jamb
- 1 - 2" x 3" x 45 1/2" - Door Header (Dado)
- 2 - 1/2" x 2 1/2" x 72" - Interior Vertical Door Stops
- 1 - 1/2" x 2 1/2" x 36" - Interior Horizontal Door Stop
- 1 - 31 1/2" x 72" - Dutch Door - 2pcs (42" and 30" high)

Gable Walls

- 2 - Left Hand Gables - Triangular shaped
- 2 - Right Hand Gables - Triangular shaped

Top Wall Plates

- 4 - 3/4" x 2 1/2" x 65 3/4" - Sides - 22 1/2 degree cut on edge
- 4 - 3/4" x 2 1/2" x 70 3/4" - Front and Rear - Angled on end

C. Rafter Section

- 18 - 1 1/2" x 3 1/2" x 80 7/8" - Rafters - angled on both ends
- 3 - 3/4" x 8 1/2" x 45 1/2" - Ridge Boards
- 1 - 3/4" x 8 1/2" x 64 1/2" - Ridge Board
- 1 - 3/4" x 8 1/2" x 72" - Ridge Board
- 4 - 1/2" x 4 1/2" x 68 1/4" - Soffits
- 3 - 3/4" x 3 1/2" x 72" - Gusssets (angle cut on both ends)

D. Roof Section

- 1 - 51" x 83 3/4" - Left Side - Shingles Overhanging Plywood (Long)
- 1 - 51" x 83 3/4" - Right Side - Shingles Overhanging Plywood (Long)
- 1 - 45 1/2" x 83 3/4" - Center - Shingles flush with Plywood (Long)
- 1 - 51" x 40 1/2" - Left Side - Shingles Overhanging Plywood (Short)
- 1 - 51" x 40 1/2" - Right Side - Shingles Overhanging Plywood (Short)
- 1 - 45 1/2" x 40 1/2" - Center - Shingles flush with Plywood (Short)

- 2 - 3/4" x 1 1/2" x 36 1/2" & 4 - 3/4" x 1 1/2" x 40 - Facia Nailing Strips
- 12 - 3/4" x 3/4" x 48" - Polygal Support Cleats
- 3 - 1/2" x 2 1/2" x 44" - Mid Ridge Caps for Polygal
- 2 - 1/2" x 5 1/2" x 44" - Outside Ridge Caps for Polygal - Facia cleats attached
- 2 - 1/2" x 4 1/2" x 44" - Center Ridge Caps for Polygal
- 6 - 20 1/4" x 48" - Polygal Panels

E. Miscellaneous Section

Bottom Skirting

- 12 - 1/2" x 4 1/2" x 45 1/4" - Bottom Skirting

Corner & Wall Trim

- 4 - 1/2" x 2 1/2" x 75" - Filler Trim
- 4 - 1/2" x 4 1/2" x 82" - Vertical Corner Trim
- 5 - 1/2" x 2 1/2" x 87" - Vertical Trim
- 8 - 1/2" x 2 1/2" x 79" - Vertical Trim
- 2 - 1/2" x 4 1/2" x 58 1/2" - Horizontal Gable Trim (Left) -angled
- 2 - 1/2" x 4 1/2" x 58 1/2" - Horizontal Gable Trim (Right) -angled
- 1 - 1/2" x 2 1/2" x 32" - Horizontal Door Trim (above Door)
- 1 - 1/2" x 2 1/2" x 8" - Horizontal Narrow Wall Trim (above Wall)

Facia Trim

- 2 - 3/4" x 3 1/2" x 82 1/8" - Angle Cut Front/Rear Facia Trim (L)
- 2 - 3/4" x 3 1/2" x 82 1/8" - Angle Cut Front/Rear Facia Trim (R)
- 4 - 3/4" x 3 1/2" x 71 1/2" - Side Facia
- 4 - Facia Detail Plates - Sides - (2@3 1/2 & 2@4 1/2" High)
- 2 - Pentagon Detail Plates (front and back)
- 4 - Triangular Corner Gable Trim Pieces (2L / 2R) Found in Gable - see step 50

Filler Shingles (5 1/2" wide)

- 14 - Long Shingles
- 4 - Short Shingles

Ridge Caps

- 21 - 16-18" long Cedar Shingle Roof Ridge Caps
- 1 - 10" long Cedar Shingle Roof Ridge Cap

Flower Boxes & Window Trim

- 7 - Flower Box Kits
- 4 Reg Window Trim Pkgs: 1 x 24 1/16" Top, 3 x 23" Bottom & Sides
- 6 Narrow Window Trim Pkgs: 1 x 19 7/8" Top, 2 x 21 7/16" Sides, 1 x 18 3/4" Bottom

Potting Shelves

- 3 - 16" x 45" - Long Potting Shelves
- 1 - 16" x 41" - Short Potting Shelf
- 4 - 1 1/2" x 2 1/2" x 38" - Potting Shelf Legs

****Miscellaneous Pieces**

- 1 pc - Spare Wall Siding
- 2 pcs - Spare Shingles - use to shim door, etc

12x12 SUNSHED HARDWARE SHEET

Hardware Kit (Provided)

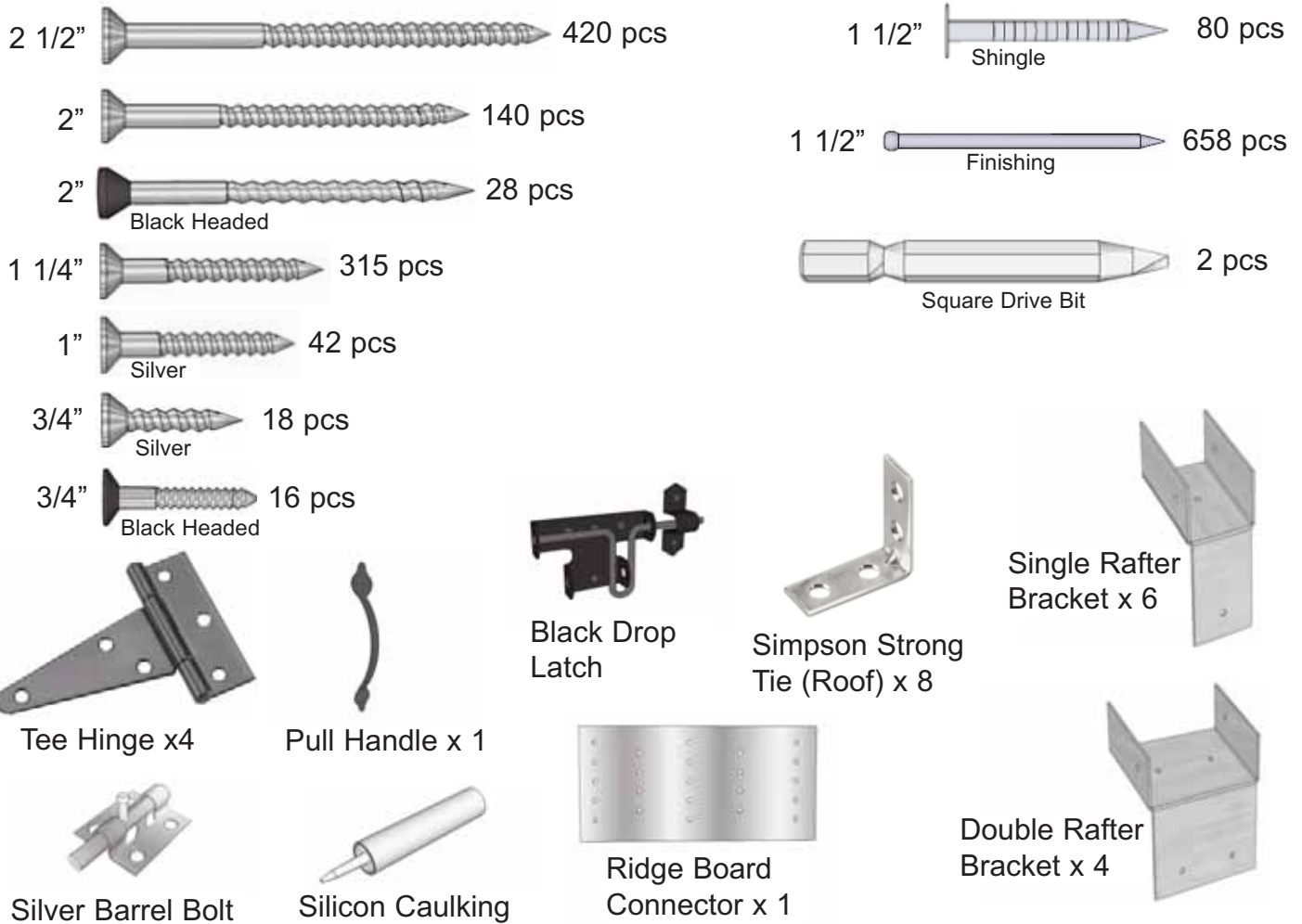

Tools Required (Not Provided)



Safety Equipment Required

(Not Provided)



Before/During Assembly:

- 1.) Paint each face and edge of your plywood floor with a latex exterior paint.
- 2.) Caulk wall seams if gaps appear.
- 3.) Caulk around window framing.
- 4.) Caulk perimeter between floor plywood and bottom wall plate.
- 5.) Caulk channels in lap siding at the top of your door above the trim, just a drop in each channel.
- 6.) Caulk edge of door threshold (if applicable).
- 7.) Optional: Install a Sill Gasket between floor runners and foundation.
- 8.) Optional: Install an 8" strip of roofing paper below Cedar Ridge Caps for Cedar Roof Sheds.

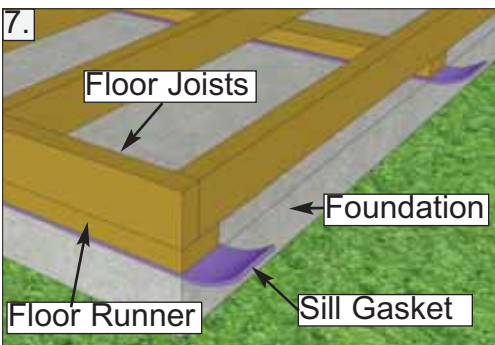
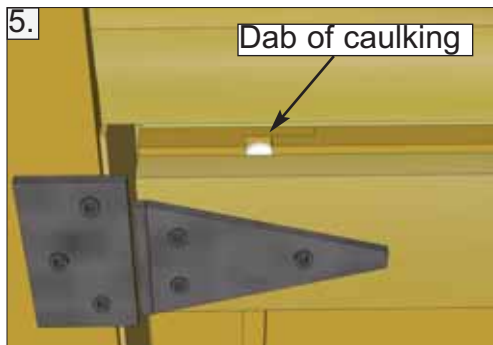
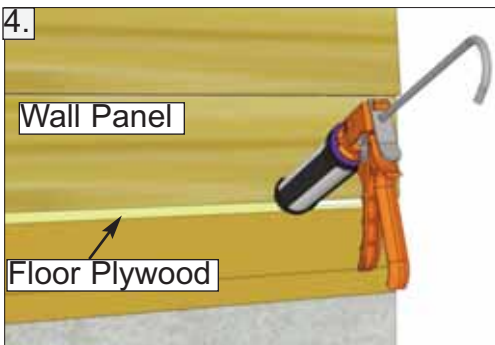
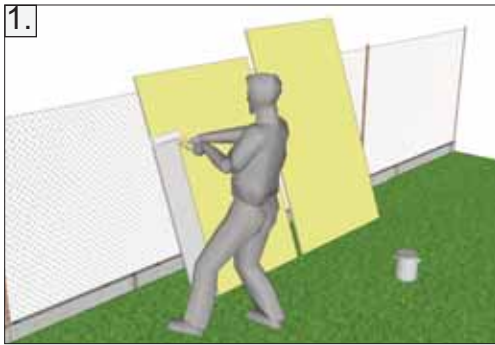

Routine Maintenance:

- Routinely check all fasteners are tight (ex. Door Hinges, Nails)
- Brush off dirt from walls.
- Brush off snow from roof regularly.
- Routinely remove needles and leaves from roof.

Painting/Staining

- Your cedar shed, if left untreated, will weather to a silvery grey colour.
- Painting or staining your structure is highly recommended and will prolong the life of your shed.
- You do not need to wait to paint or stain your shed, the wood in your kit has been dried and can be stained or painted immediately.
- Consult your local paint store for the best paint or stain for cedar.
- Optional: stain the inside of your shed. (Note: this will remove the fresh cedar smell.)

A. Floor Section

Exploded view of all parts necessary to complete Floor Section. Identify all parts prior to starting. Note, Floor Footprint is 136 1/2" deep x 141 1/2" wide.

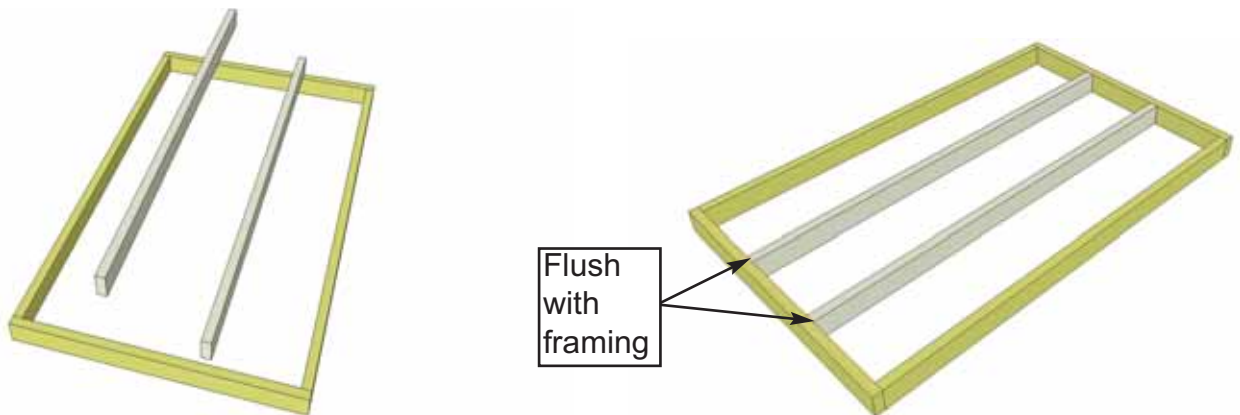
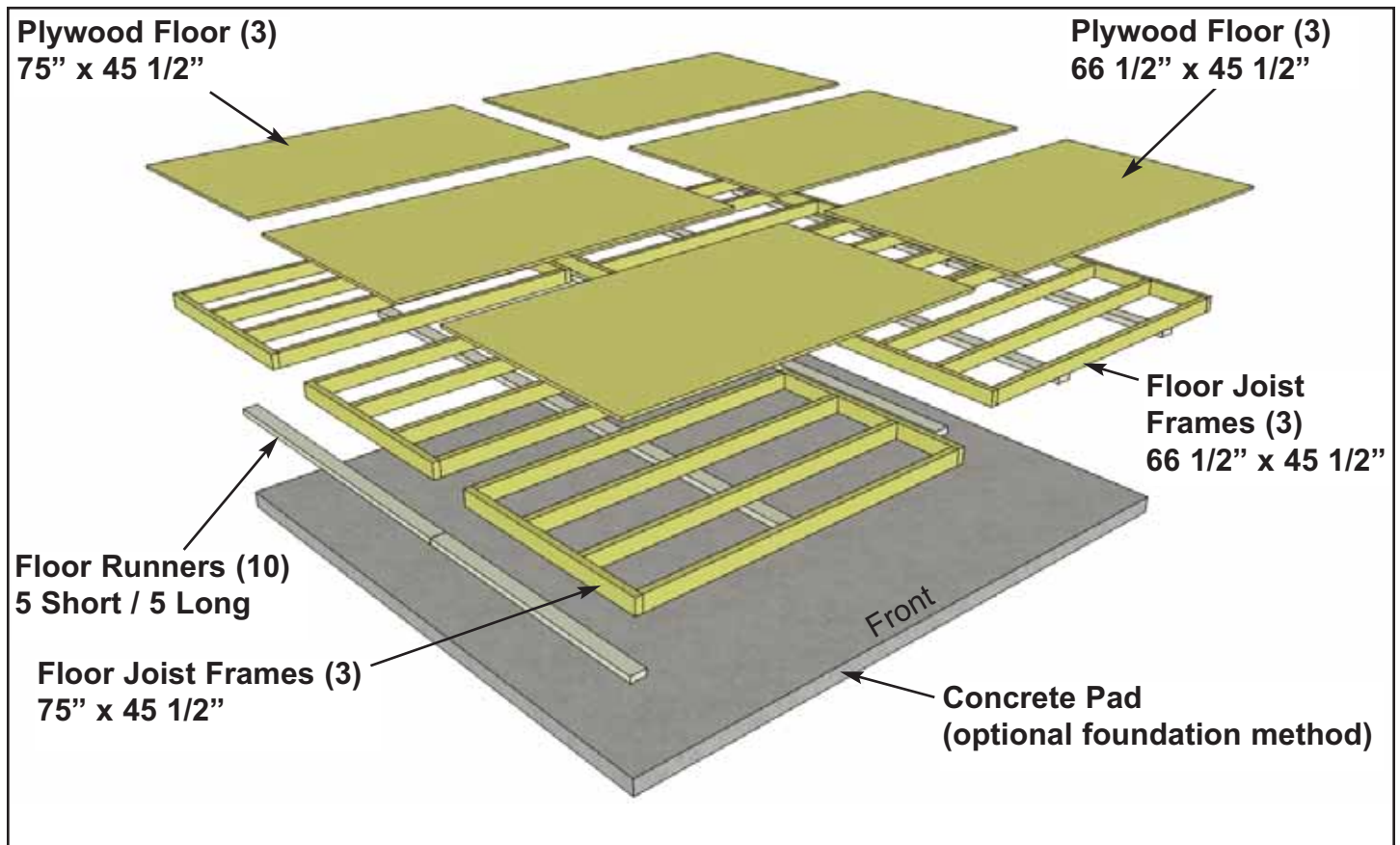

- 1.** Lay out all **Floor Joist Frames and Floor Joists** on ground as illustrated above. Position 71 7/8" Floor Joists in 75" frames and 63 1/2" Floor Joists in 66 1/2" frames. Position Joists equally in Floor Joist Frame. Position Joist so flush with framing.

You can find the Square Drive Bit for the screws in with the Hardware Kit Bag.

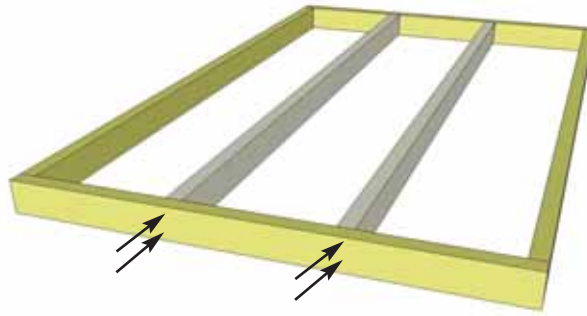

2. When correctly positioned, attach each Joist with 4 - 2 1/2" screws (2 per end). Complete all Floor Frame and Joist connections. **You can find the Square Drive Bit for the screws in with the Hardware Kit Bag.**

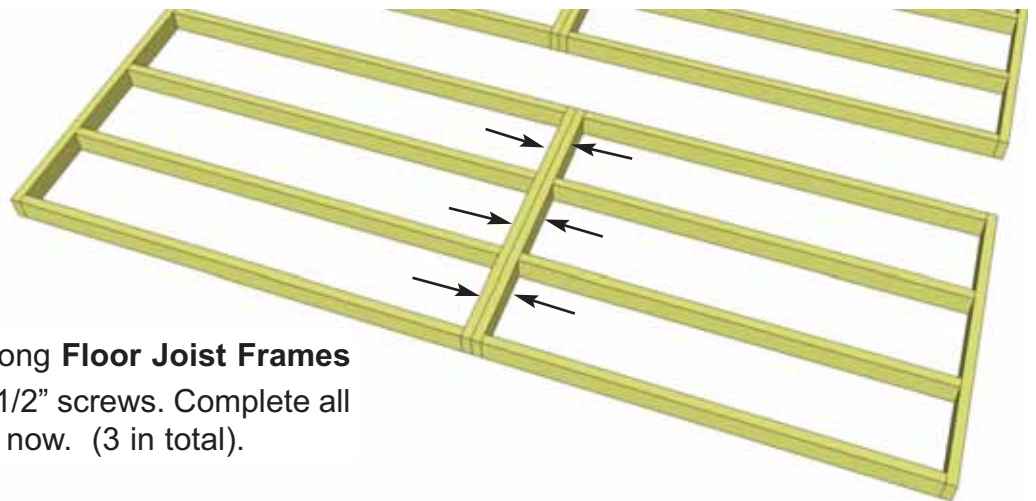

3. Lay out 66 1/2" and 75" long **Floor Joist Frames** and attach together with 6 - 2 1/2" screws. Complete all Long and Short Floor Frames now. (3 in total).

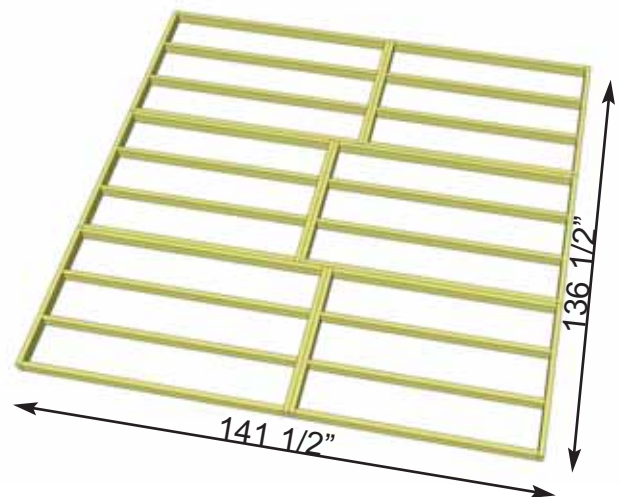
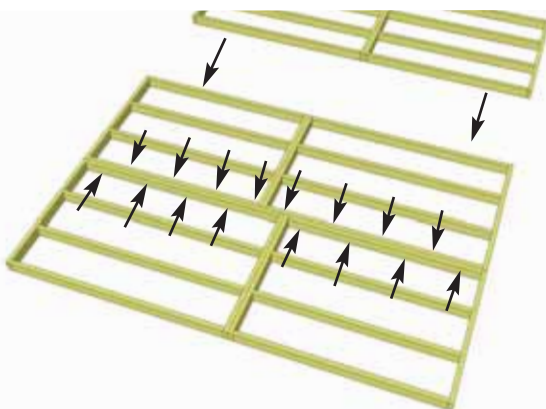

4. Now attach each completed section together with 16 - 2 1/2" screws as illustrated above.

5. When completed, your floor footprint should be 136 1/2" deep x 141 1/2" wide.



6. Attach **Floor Runners** to completed floor frame. There are 2 floor runners per 136 1/2" side and 5 completed runners in total. Use 6 - 2 1/2" screws per Runner.

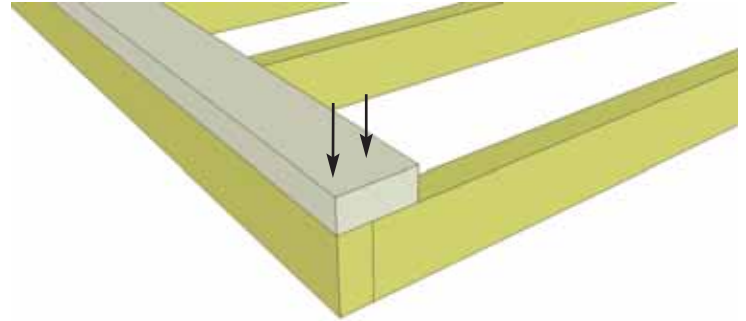

7. Make sure Runners are flush with outside and front and rear floor framing, not overhanging.

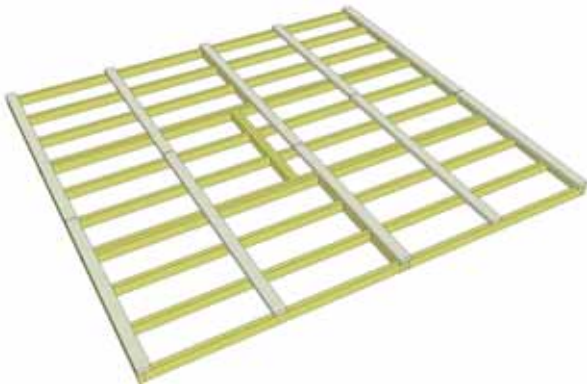

8. Complete all Floor Runners.

Foundations

Note: The floor will be flipped over and floor runners will sit on your foundation. It is important to note that having a level foundation is critical. Choosing a foundation will vary between regions. Typical foundations can be concrete pads or patio stones positioned underneath the floor runners.

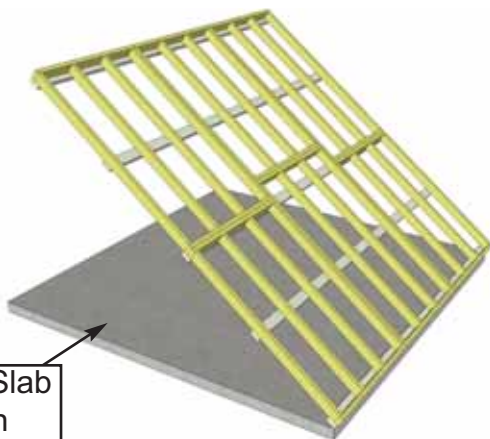

Concrete Slab Foundation

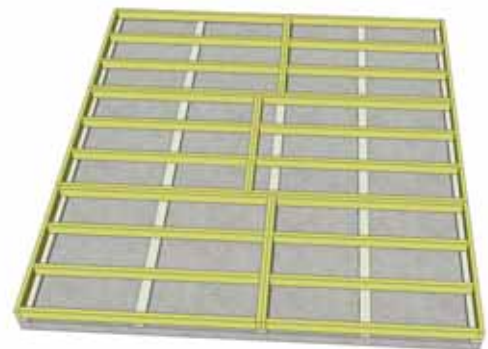

9. With Floor Runners attached, carefully flip the floor over and place on your foundation. **Caution:** you will need 2 people to assist you. Be careful when laying floor down not to bend or twist floor. When in place, level floor completely.

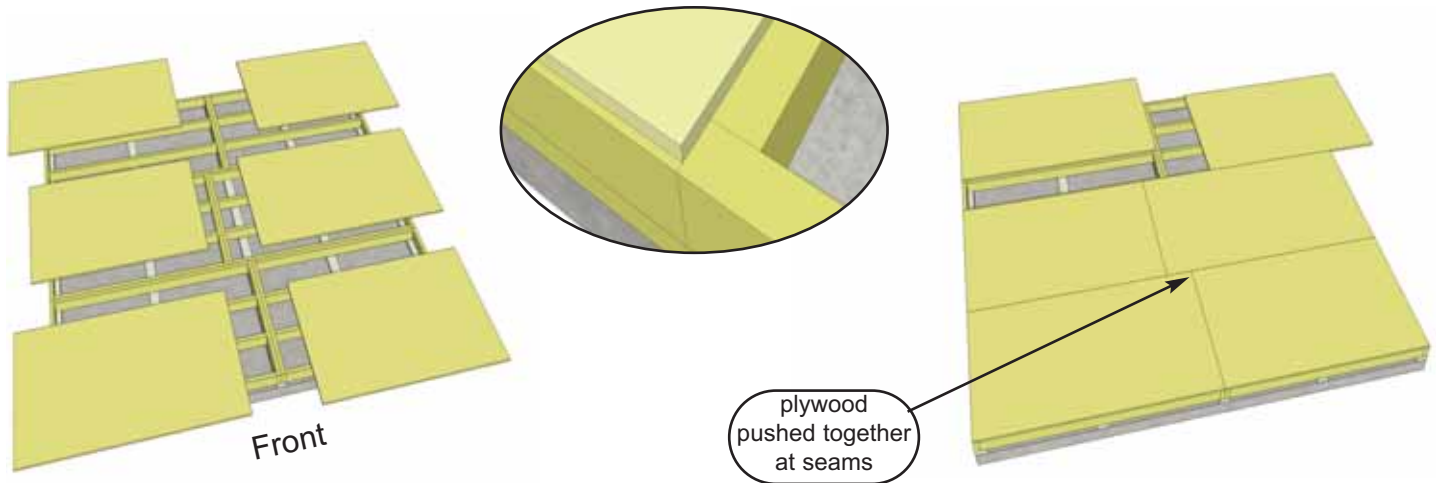

10. Position **Plywood Floor** pieces (6) on top of completed Floor Joists. Plywood will sit slightly back from outside edge of Floor Joist Framing.

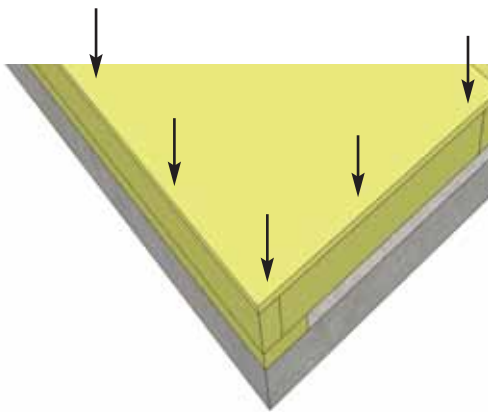

Hint: Use a chalk line to mark location of floor joists to determine screw placement.

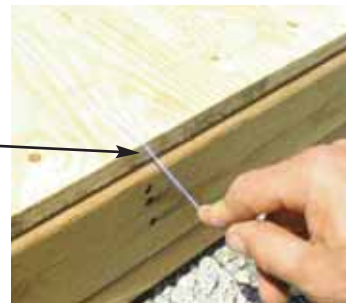

11. With Plywood positioned correctly on floor framing, attach with 1 1/4" screws. Use screws every 16" (approximately 85 total). The Plywood is cut slightly smaller than floor framing. Keep plywood seams tight.

Important: Check to confirm that your floor is level prior to proceeding to the next step of wall assembly.

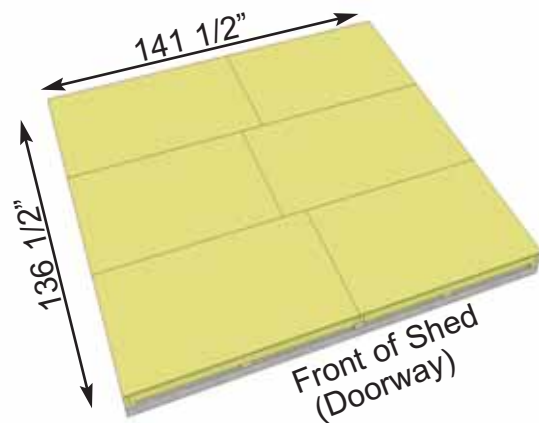

B. Wall Section

Important: Pilot hole **ALL** 2x3 Wall Studs with 1/8" drill bit prior to screwing. This will make it much easier to attached together.

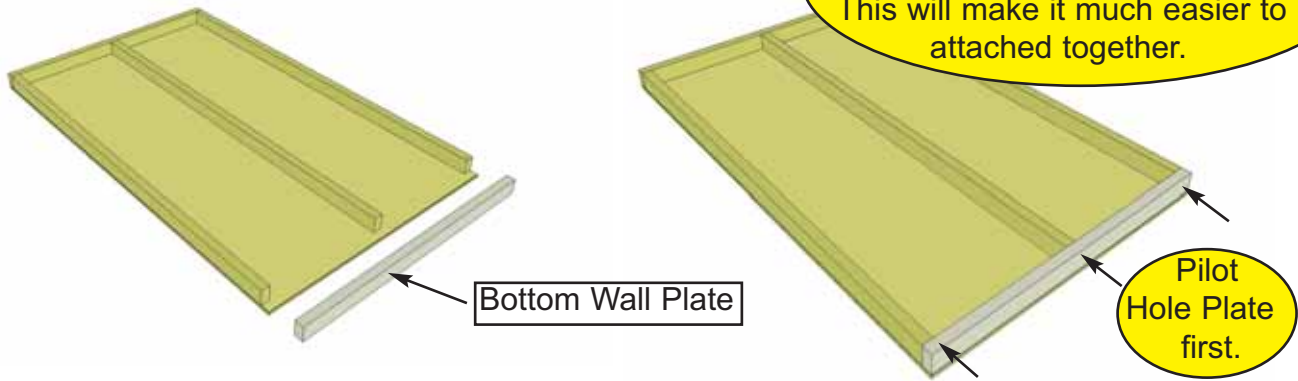

12. Starting with **Solid Wall Panels**, carefully lay panel face down. Position and attach **Wall Plate** to bottom of wall studs of each wall panel with 3 - 2 1/2" screws. Position so plates are flush with framing. **Note:** bottom Wall Plates may already be attached to some Solid Walls.

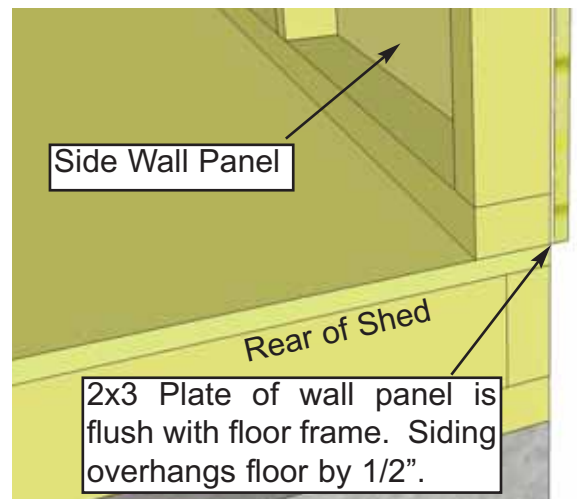
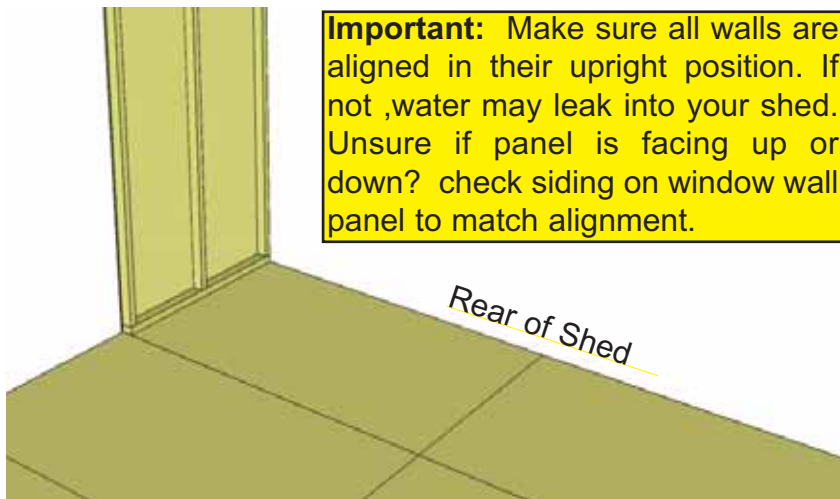

13. Starting at Rear Corner, position a Solid Wall Panel on top of plywood floor. Make sure panel is facing up. The side wall panels will sit flush with floor frame with the front and rear panels sandwiched between them. **Note:** siding will overhang the floor by approx. 1/2".'

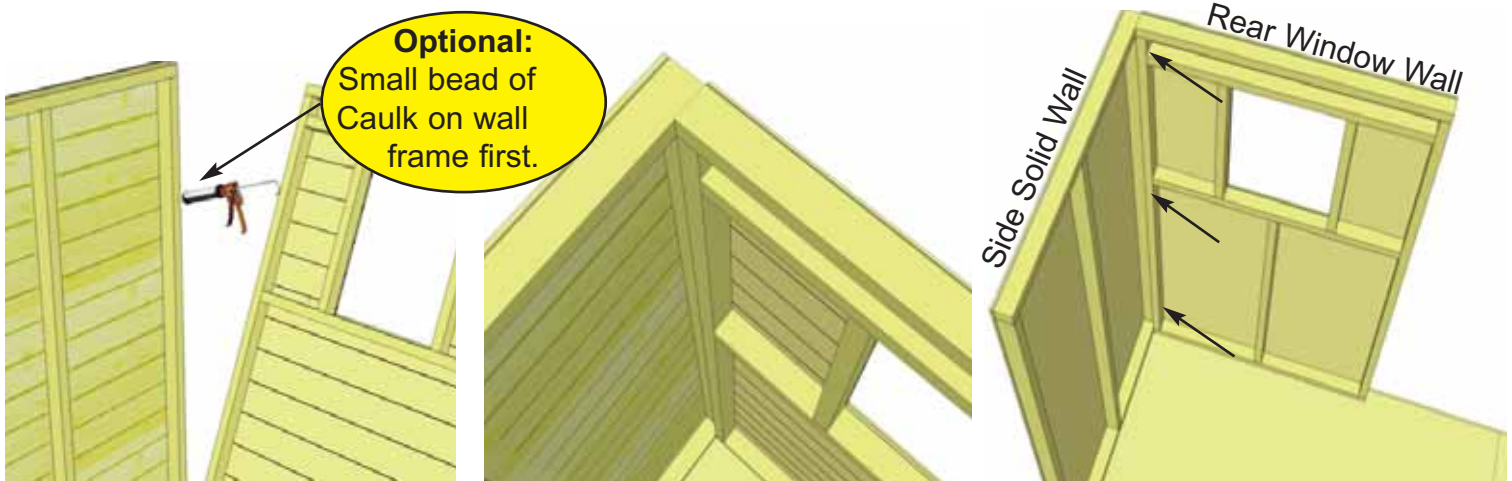

14. Position rear Window Wall Panel into place on plywood floor. Butt both vertical wall studs of side and rear walls together and attach with 3 - 2 1/2" screws. Screw at the bottom, middle and top of stud to secure properly.

Note: We recommend you wait to install the windows last, so they don't get damaged during construction.

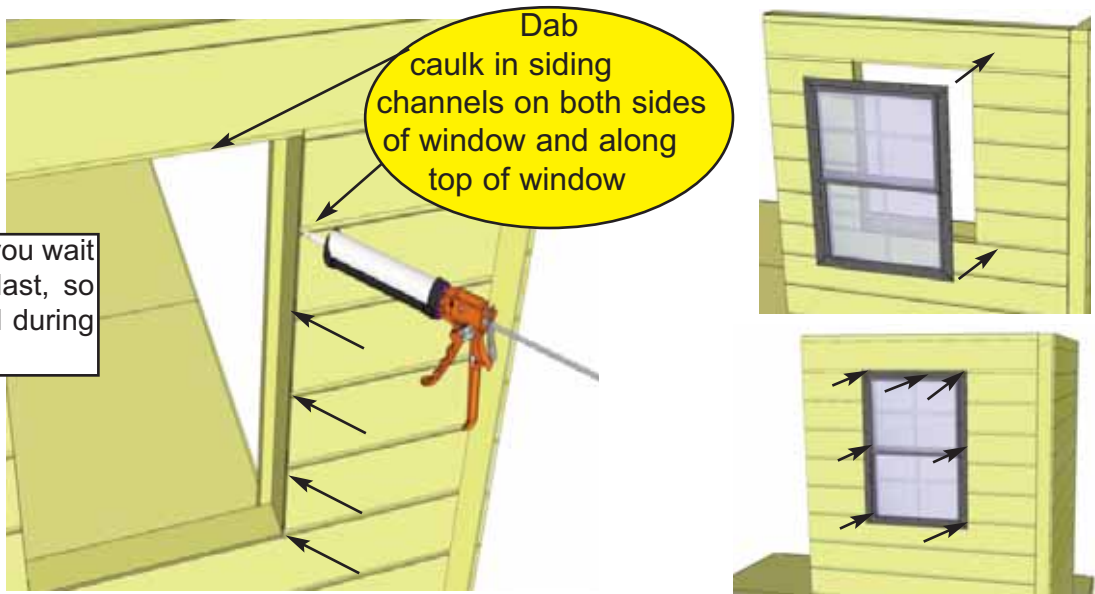

15. Locate **Window Inserts for Regular Window Walls.** Before installing, dab caulk in siding channel on both sides and across top of window opening. This will prevent water from getting in behind window. Position window in cavity and secure with 8 - 1 1/4" screws. Later, Window Trims will be installed to hide caulking. Complete Window Inserts as walls are erected, or at the end of construction so they don't get damaged while you work.

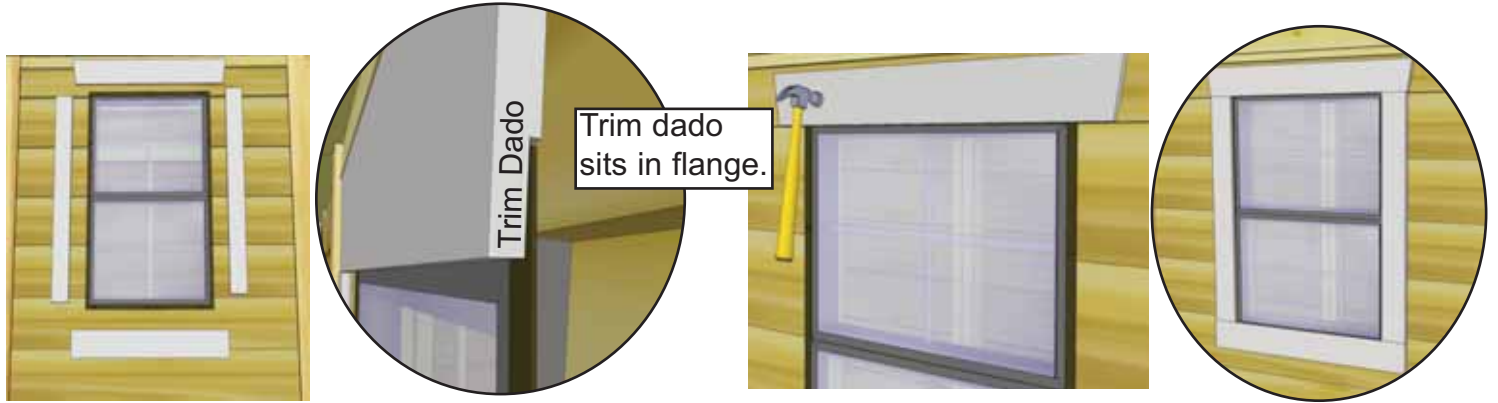

16. Position Window Trim around window doing a dry run first and attach with 4 - 1 1/2" finishing nails per piece. There are two Trim Kits (Regular / Narrow). The regular window kit = 1 x 24 1/16" = top (angle cut on ends) / 3 x 23" = Sides & Bottom. Narrow window kit = 1 x 19 7/8" Top, 2 x 21 7/16" Sides, 1 x 18 3/4" Bottom. Window trim has a small dado on reverse face. Outside flange of window will roughly sit in the dado to give a better fit.

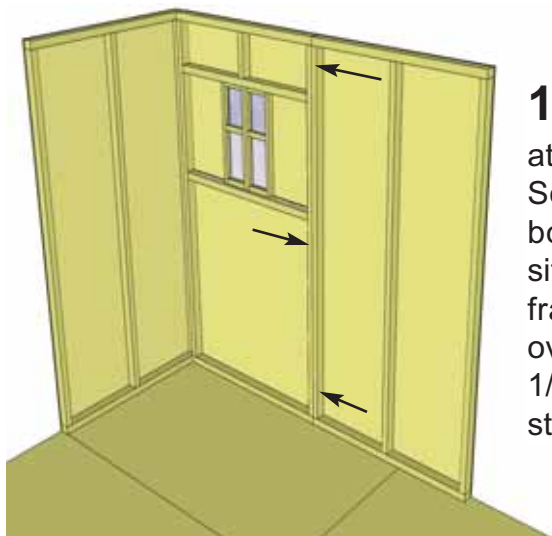

17. With the corner wall attachment complete, position a Solid Rear Wall Panel so bottom 2x3 wall framing is sitting flush with outside floor frame. Wall siding should overhang floor by approximately 1/2". Attach rear wall panel studs together as per **Step 14.**

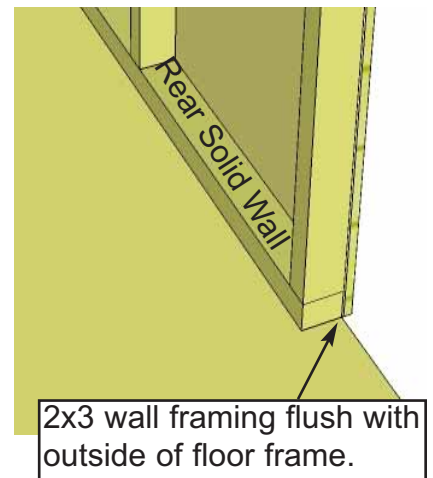

18. Position the final Rear Panel on the floor (Window Wall Panel). Position vertical wall studs together and attach as per **Step 14**.

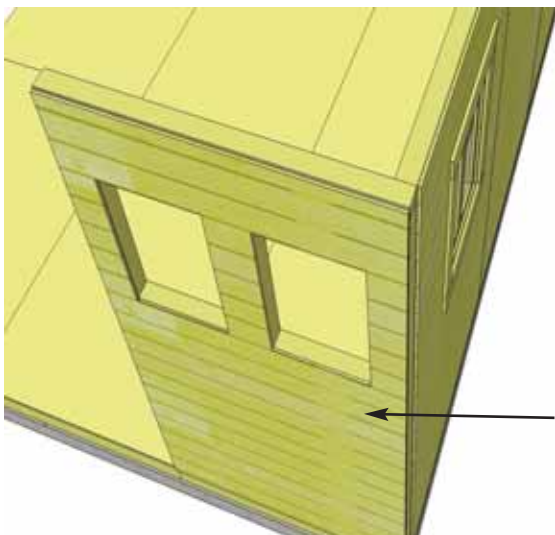
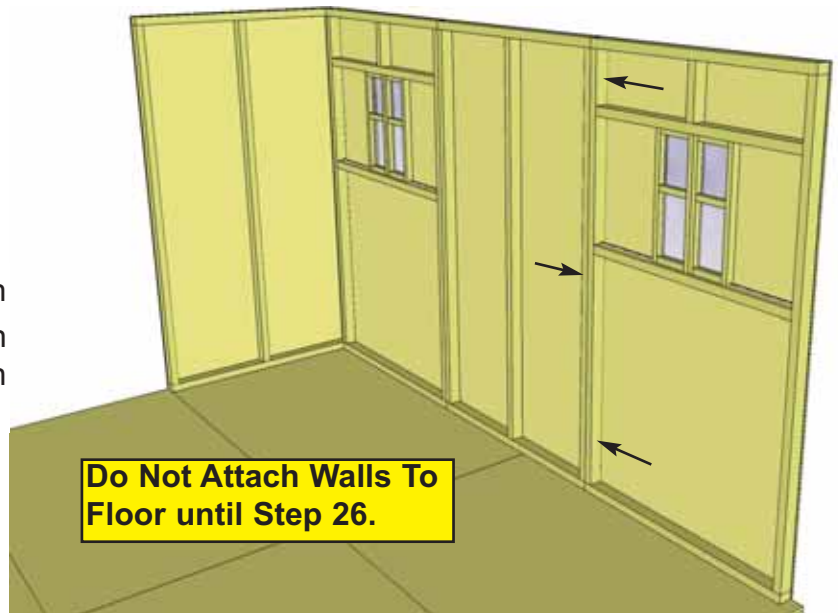

Be sure that rear wall panels fit between side wall panels (sandwiched).

Side Window Wall Panel

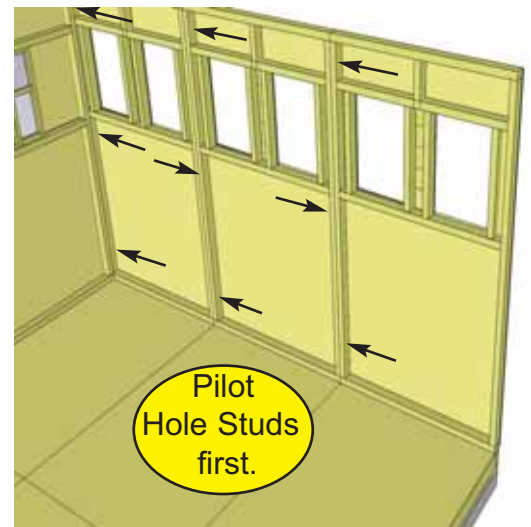

19. Attach a Side Window Wall Panel (2 windows in panel) in corner. Attach as per **Step 14**. Start positioning and securing remaining Side Window Wall Panels on your floor. Attach wall studs together as per **Step 14**.

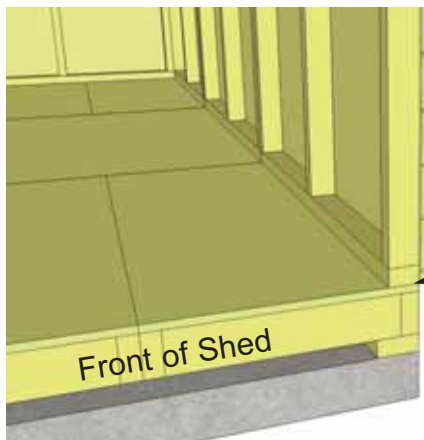

Wall panel will sit flush with floor framing at front of shed.



20. Complete attachment of left Side Wall Panels. At the front of the shed, side walls will sit flush with front of floor framing.

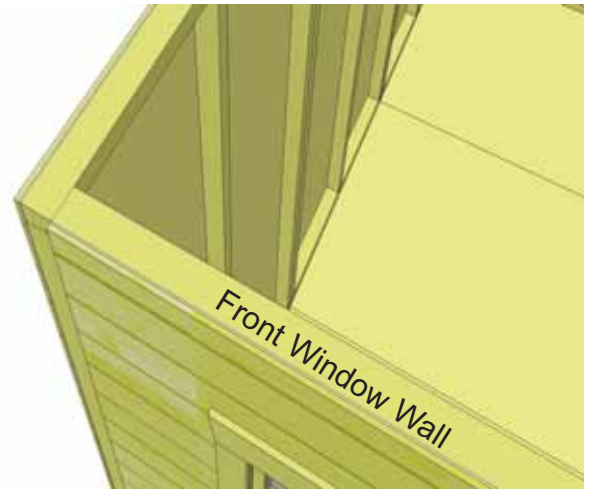
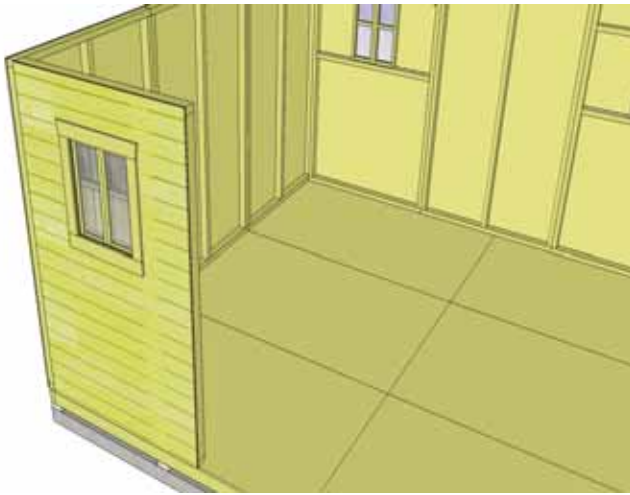

21. In the Front Corner, attach a Window Wall Panel. Line wall studs up as per **Step 14** and secure together.

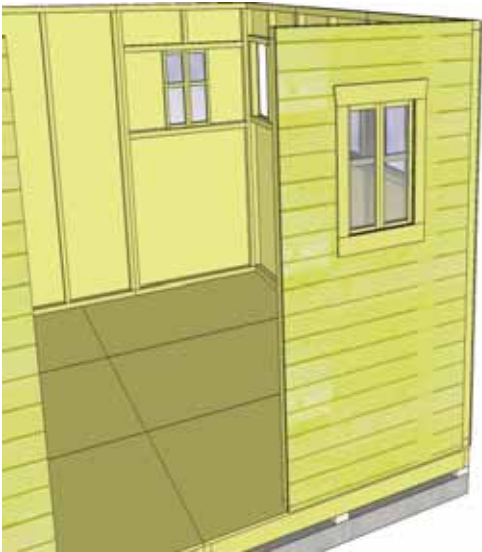

Narrow Wall Panel (can go on left or right side).

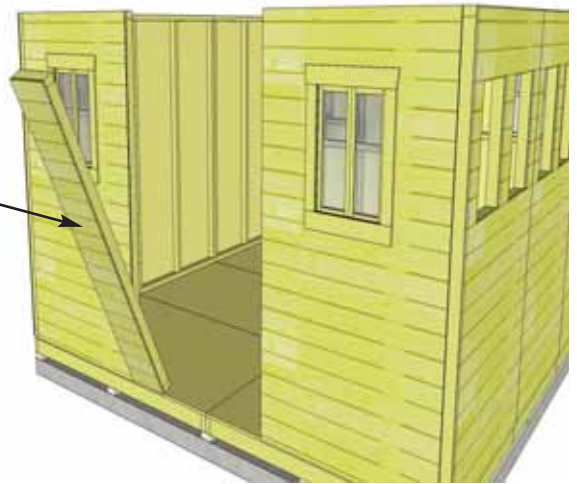

22. Secure 2nd Front Corner Window Wall Panel. Place Narrow Wall Panel adjacent to either left or right Window Wall - your choice.

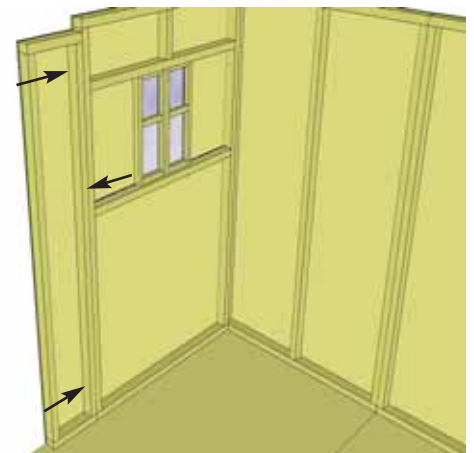

23. Line up Window Wall and Narrow Wall so flush with each other on the outside. Attach studs together with 3 - 2 1/2" screws as per **Step 14**. **Note:** Narrow Wall is 73" high (2" shorter than Window Wall).

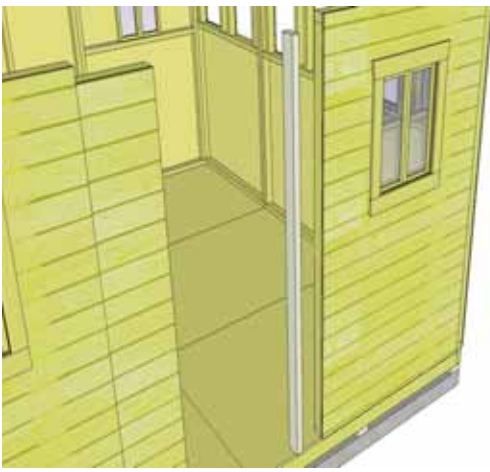

Jamb sits flush with Wall framing

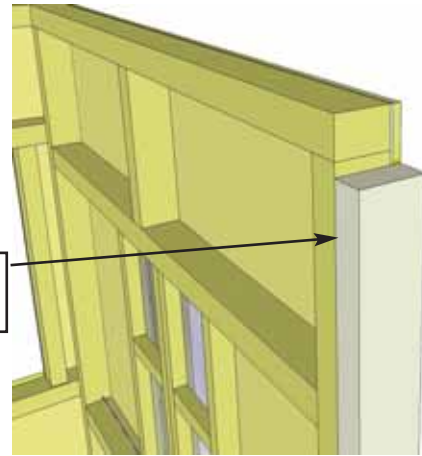

24. Locate Vertical Door Jamb and position flush against right wall panel stud. The Jamb is 3" wide and will sit flush to outside of wall siding. When positioned correctly, secure Jamb using 4 - 2 1/2" screws.

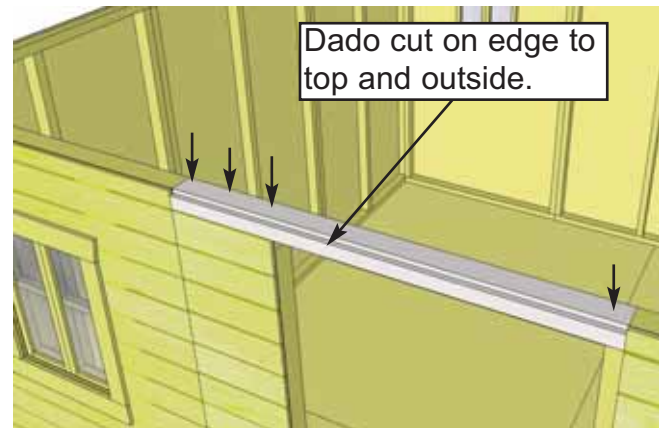
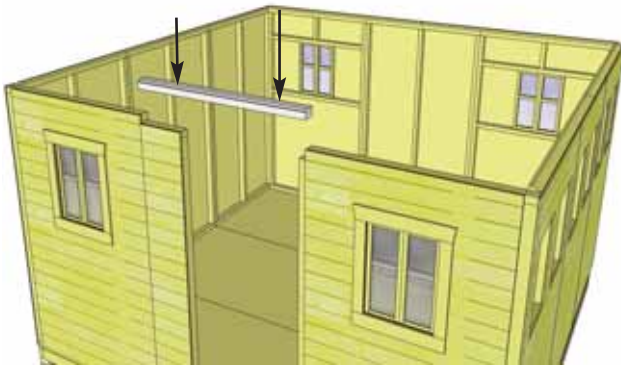

Dado cut on edge to top and outside.

25. Position and attach the Door Header to Door Jamb and Narrow Wall Panel top framing. Header should sit flush with Door Jamb and Outside of Narrow Wall Siding. Attach with 4 - 2 1/2" screws.

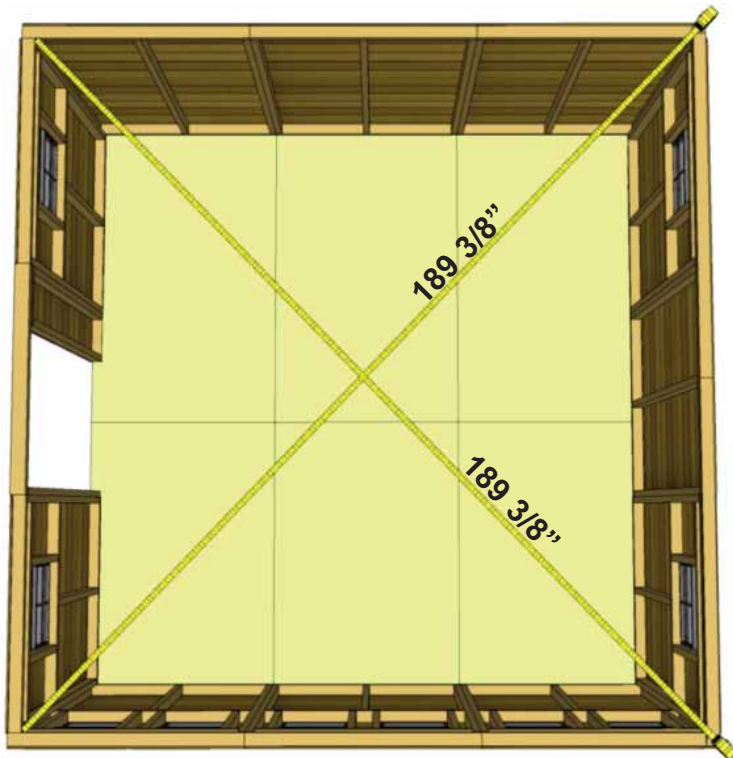

Advice: Prior to fastening walls and installing rafters, take time to confirm your walls are level, square and plumb.

Measure diagonal at top and bottom of walls corner-to-corner. This should be approximately 189 3/8". More importantly, if measurements are not within 1/4", your walls are not square. Adjusting now will make it easier to the roof section later.

Important: If walls are not lining up and appear higher or lower than each other, please check the level of your floor. You may need to make slight adjustments before proceeding.

26. When all walls are attached together, check alignment with the floor. Bottom wall framing should sit flush with outside of floor joists. When positioned correctly, fasten bottom wall plates to floor using 4 - 2 1/2" screws per wall panel. **Confirm 32" wide door opening at bottom.**

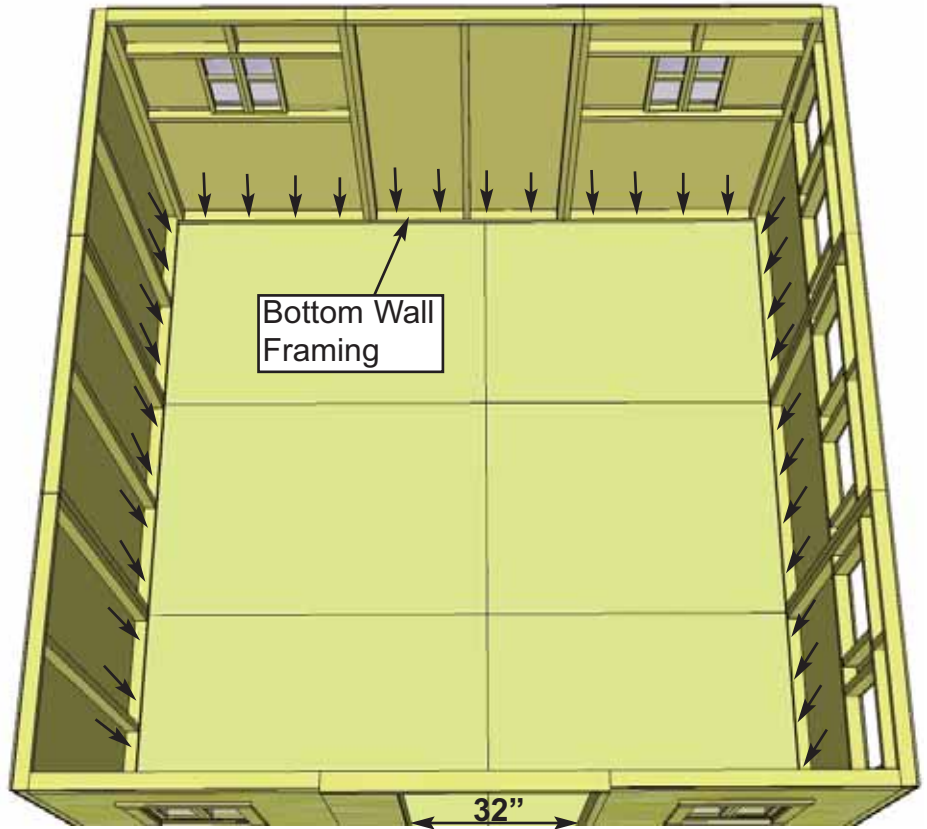

Angle screws into perimeter Floor Joists.

Optional: Caulking seams will help prevent moisture from entering your shed. Caulking is included to complete polygal Windows only. Additional Caulking may be required.

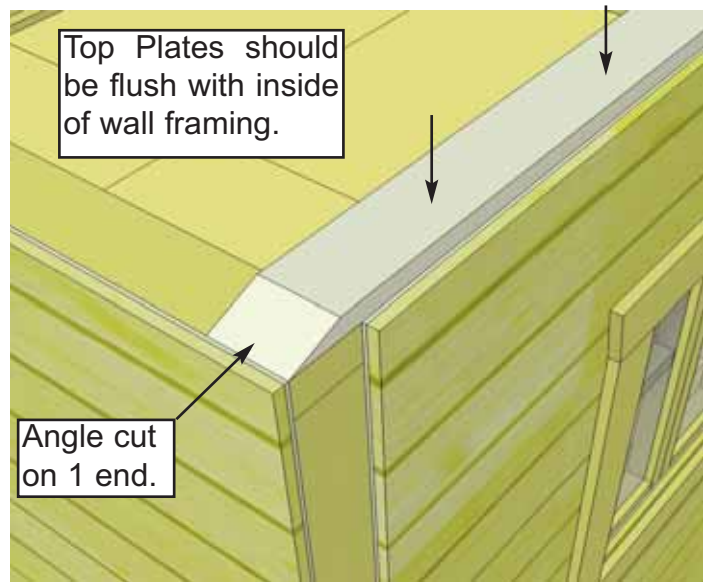
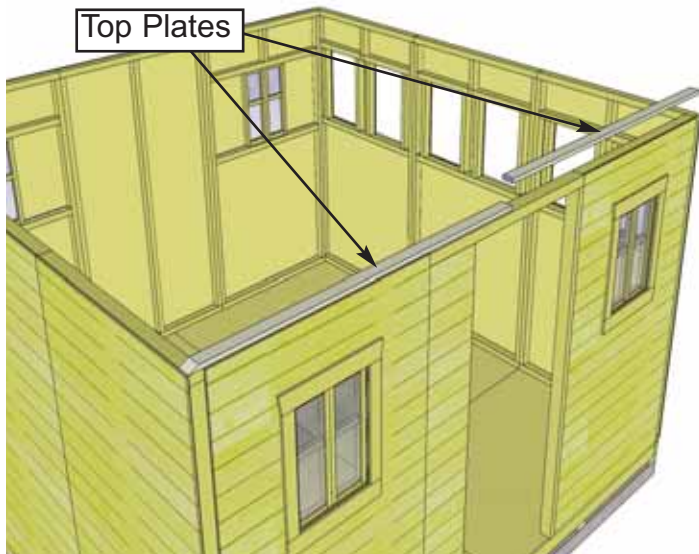
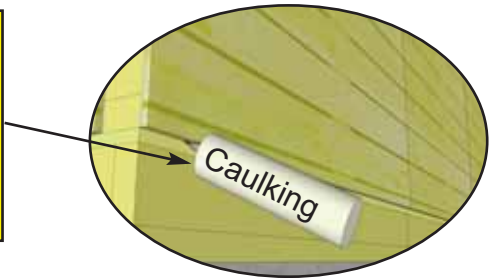

27. Position **Front Top Plates** on top of wall framing so they are flush on the inside with 2x3 wall frame. There are 2 Front Top Plates. Together, the plates should be centered evenly on the wall left to right. Attach by screwing down into top wall framing with 4 - 2" screws per Plate.

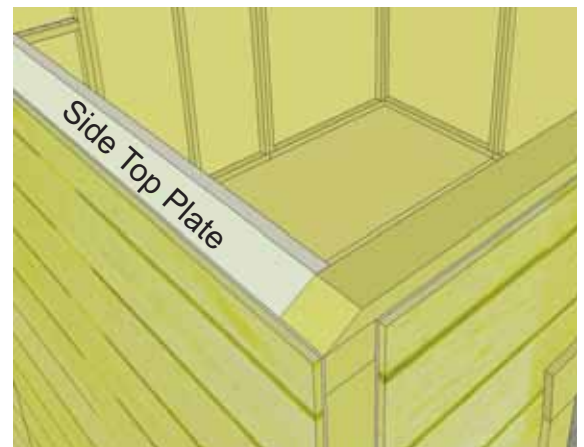
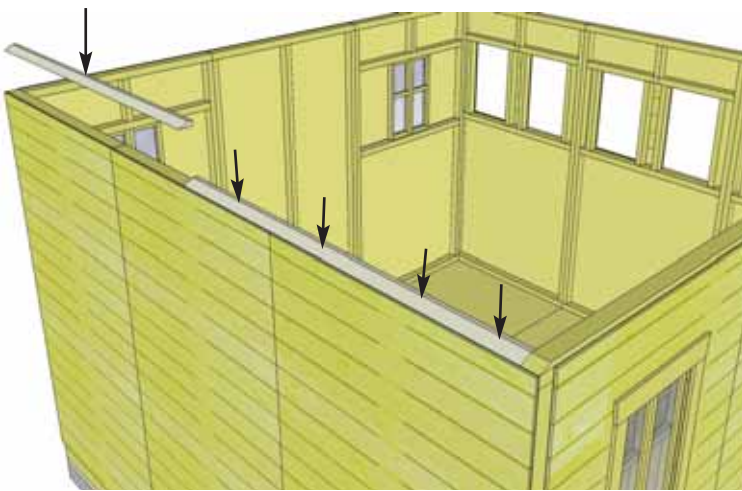

28. Next, attach the 2 **Side Top Plates**. The side top plates are angle cut down the length. Once again, position top plate on wall plate so it is flush with inside of wall plate. Side plate should also be flush with Front Top Plate. Secure with 4 - 2" screws per piece.

Rear Top Plates

Side Top Plates

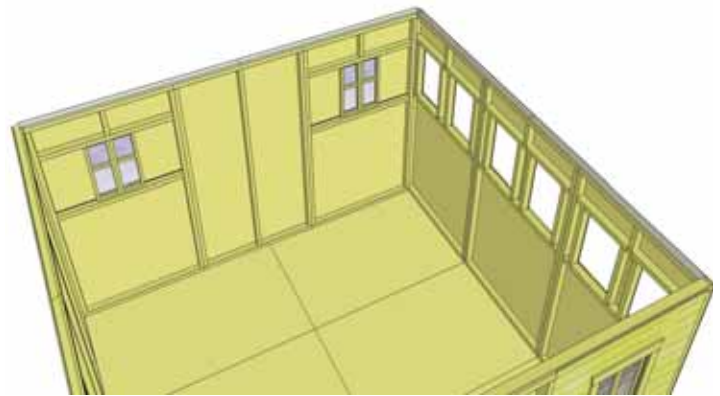
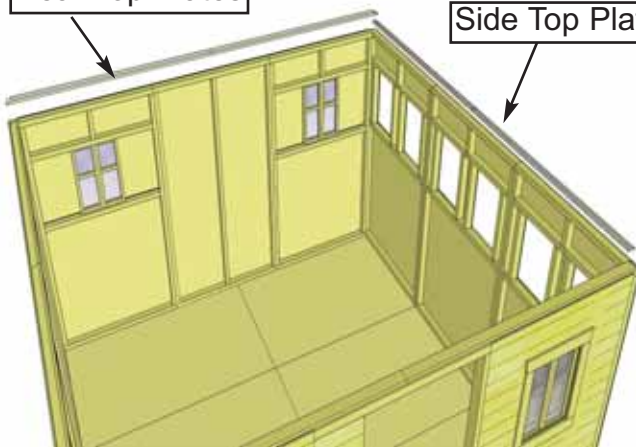

29. Position remaining Rear and Side Top Plates on wall top framing to complete. Use 4 - 2" screws per piece.

Lap Siding of panels will fit together.

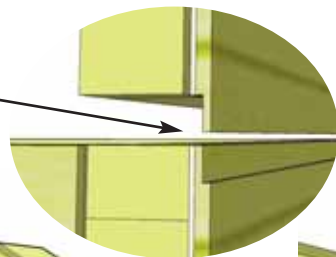

Straight Edge to line up angles

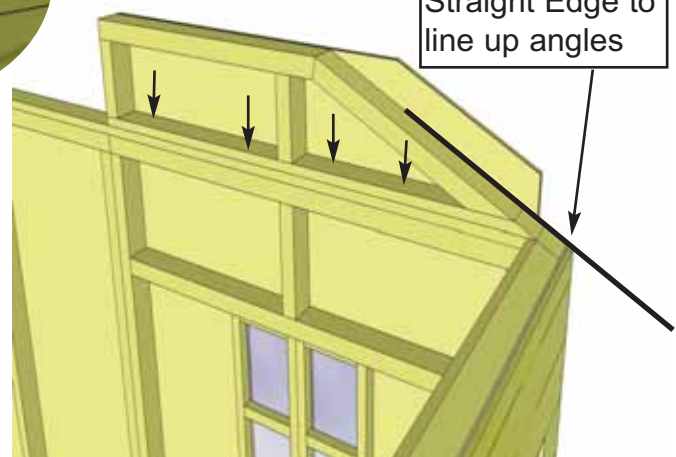
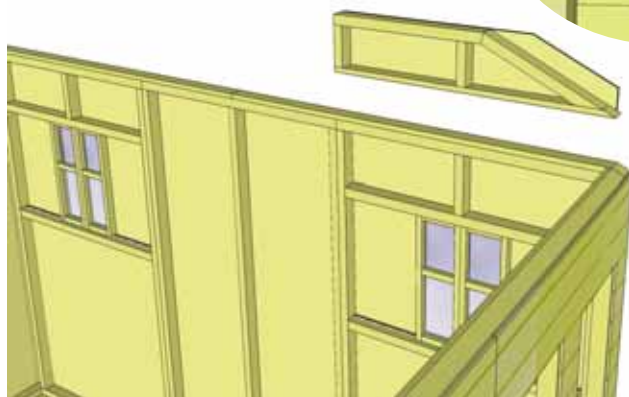

30. Locate and place an **Angled Wall Extendor** on Rear Wall Top Plate. Position so Top Plate and Extendor Wall angles line up and are flush with each other. When in place, secure with 4 - 2 1/2" screws.

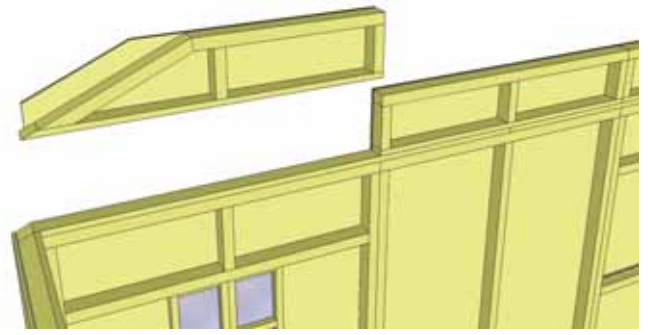
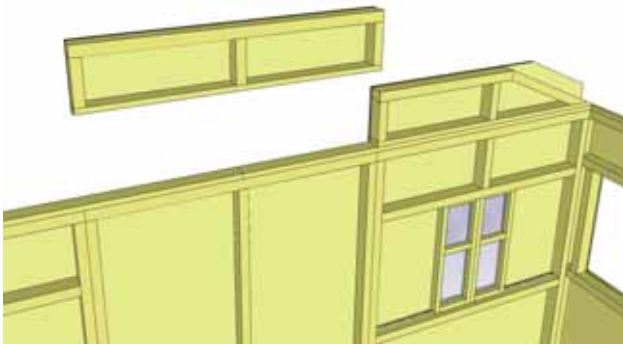

31. Locate and place the **Middle Wall Extendor** on Top Plate and flush with Angled Extendor Wall framing. When correctly in place, secure with 4 - 2 1/2" screws. Complete remaining Angled Wall Extendor attachment. Use 4 - 2 1/2" screws to connect Middle Wall to Angled Extendor Walls. See **Step 32**.

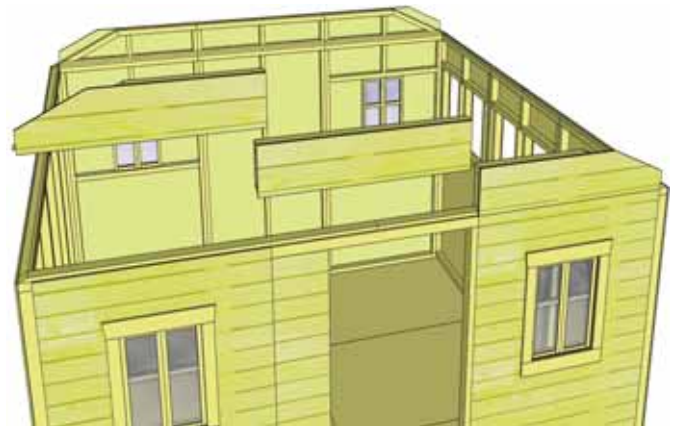
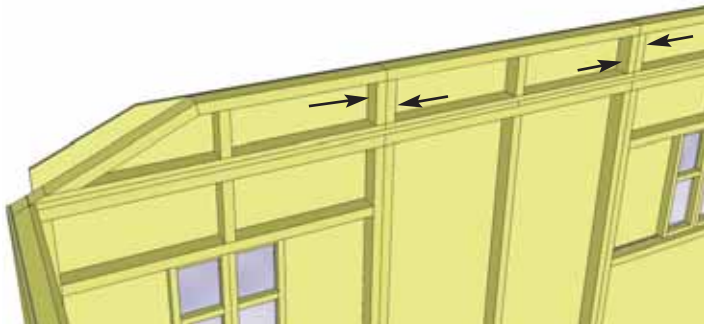

32. After completion of Rear Wall Extenders, complete the front wall Extenders following **Steps 30-31**.

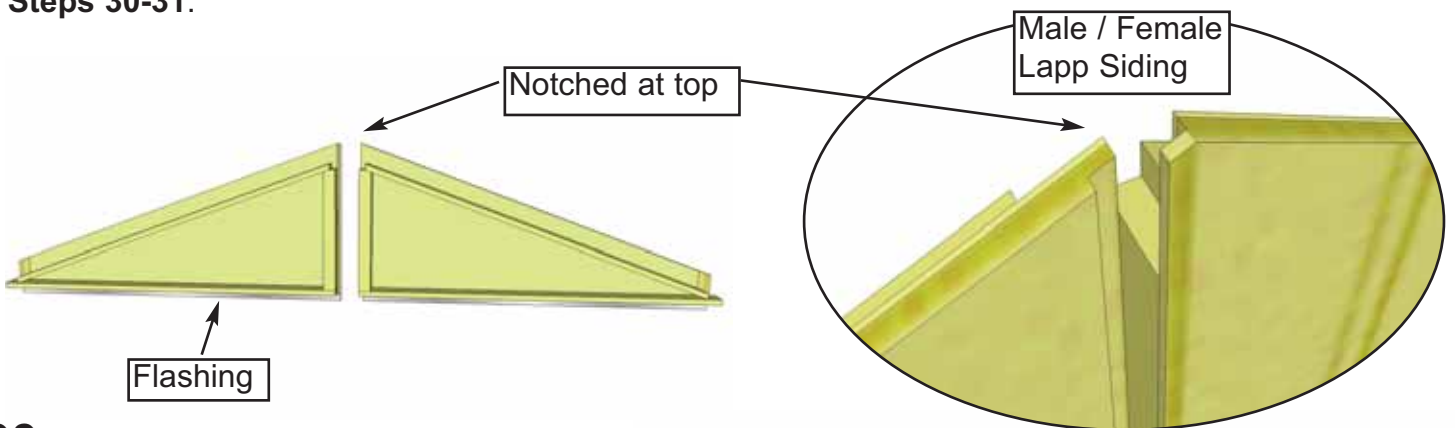

33. Locate Gable 1/2 Walls for both sides of the shed. Align framing and wall siding lapp together. Screw center wall framing of each piece together with 3 - 2 1/2" screws.

Note: prior to attaching, try each combination of Gables for best fit.

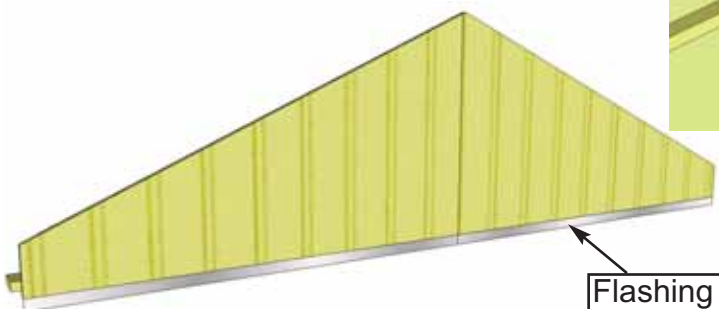
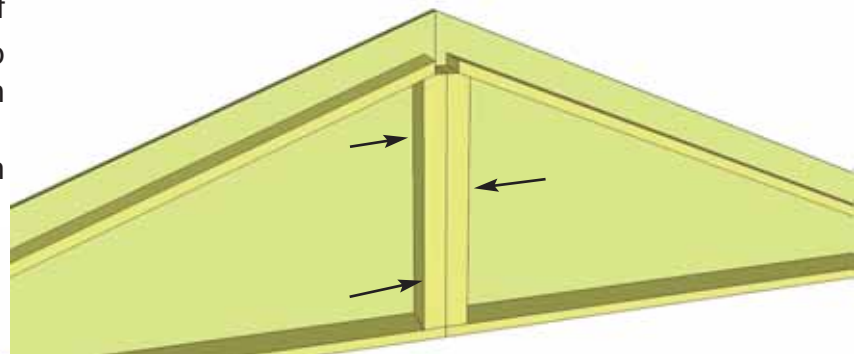

34. Lift completed Gable Section up and place on top of front Wall Extenders. Move Gable Section framing left to right to line up with Wall Extendor framing. Use a straight edge to check for correct alignment. When in place, tack down Gable framing for now with 4 - 2 1/2" screws. **Note:** Gable alignment may need to be adjusted after Rafters are installed.

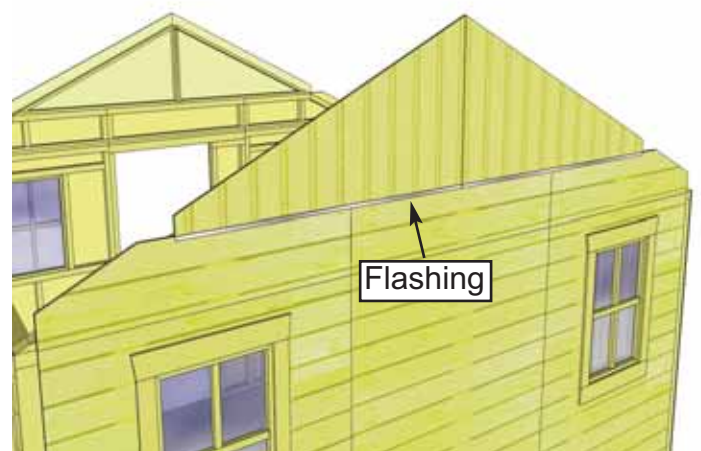
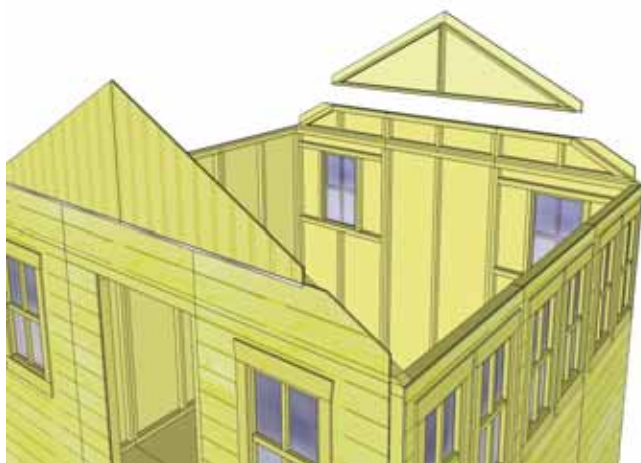
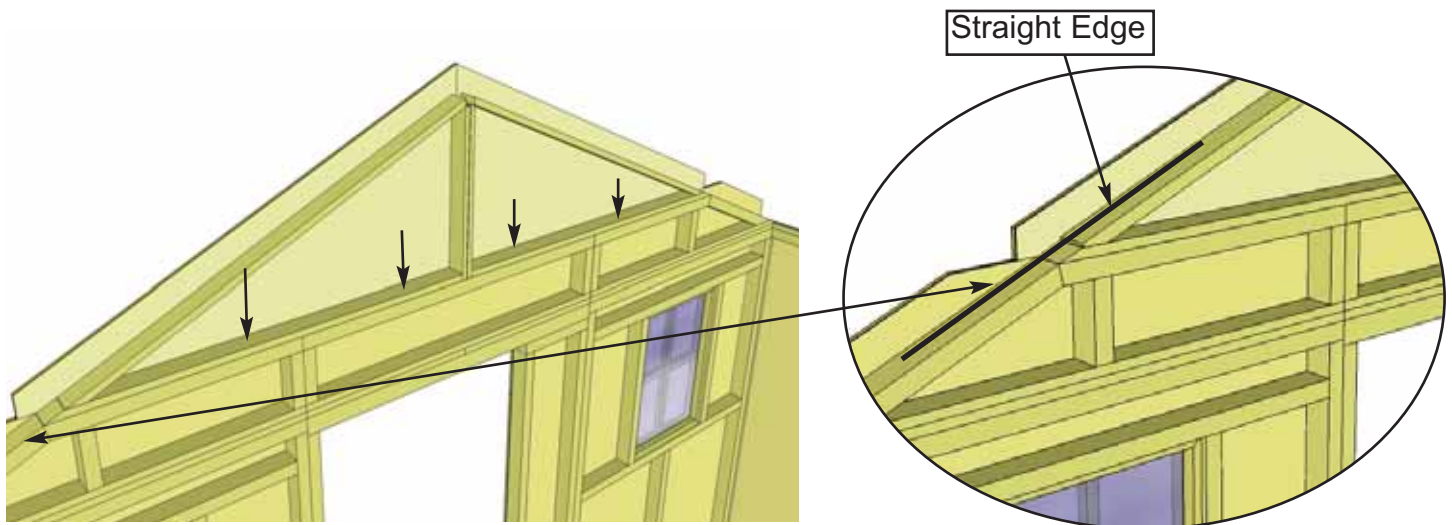

35. Lift, align and attach **Rear Gable Section** as per **Step 34**.

C. Rafter & Roof Section

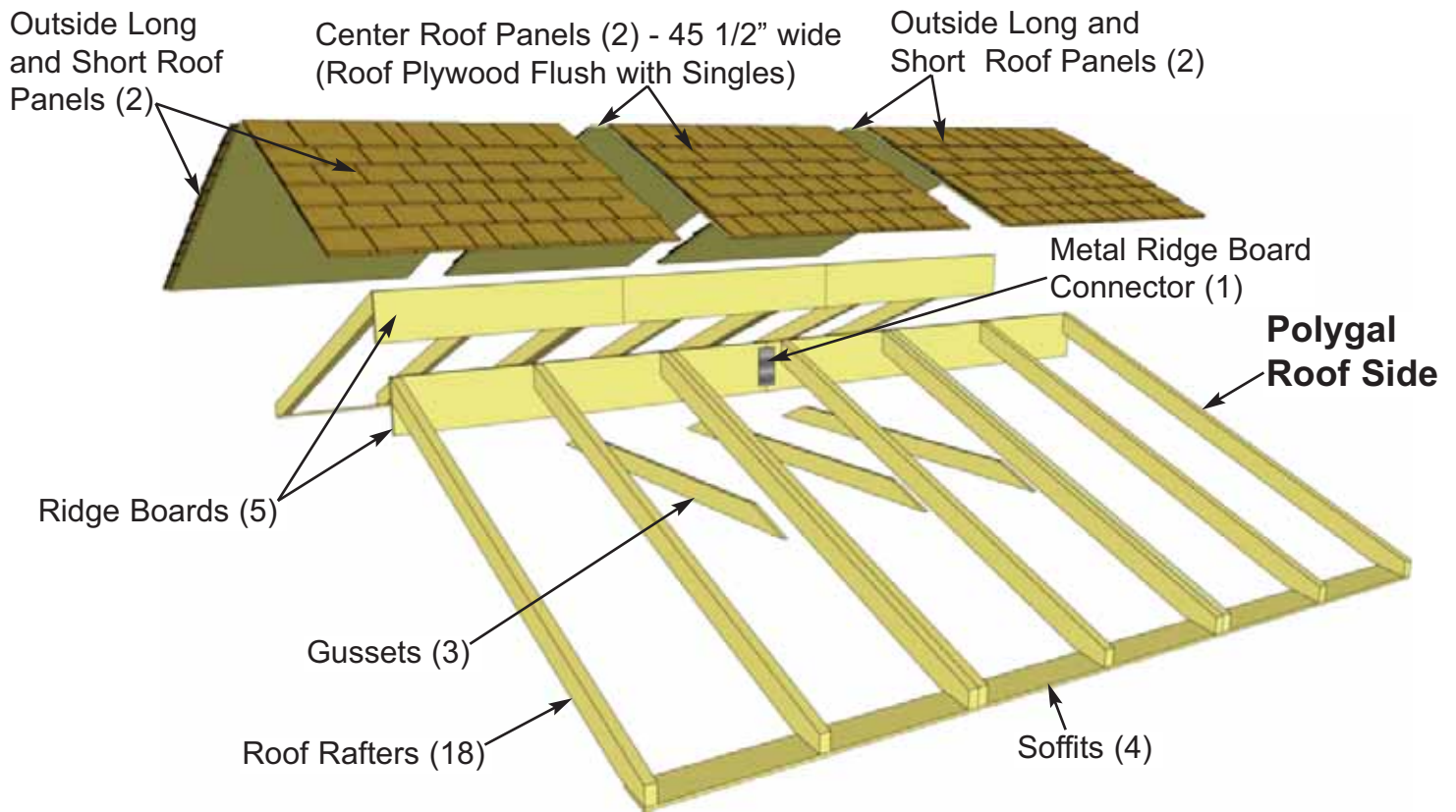

Important: Locate all parts necessary to assemble each Rafter Section prior to beginning.

- Parts for One Rafter Section**
- 9 - 1 1/2" x 3 1/2" x 80 7/8" - Rafters
 - 1 - 3/4" x 8 1/2" x 64 1/2" - Ridge Board
 - 1 - 3/4" x 8 1/2" x 72" - Ridge Board
 - 2 - 1/2" x 4 1/2" x 68 1/4" - Soffits
 - 1 - Metal Ridge Board Connector
 - * Must complete 2 Rafter Sections

- Parts for Other Rafter Section**
- 9 - 1 1/2" x 3 1/2" x 80 7/8" - Rafters
 - 3 - 3/4" x 8 1/2" x 45 1/2" - Ridge Boards
 - 2 - 1/2" x 4 1/2" x 68 1/4" - Soffits

- Remaining Rafter Pieces:**
- 3 - 3/4" x 3 1/2" x 72" - Gussets

Follow **Steps 36-38** to Assemble Rafter Sections. Make sure to complete on a flat, level surface.

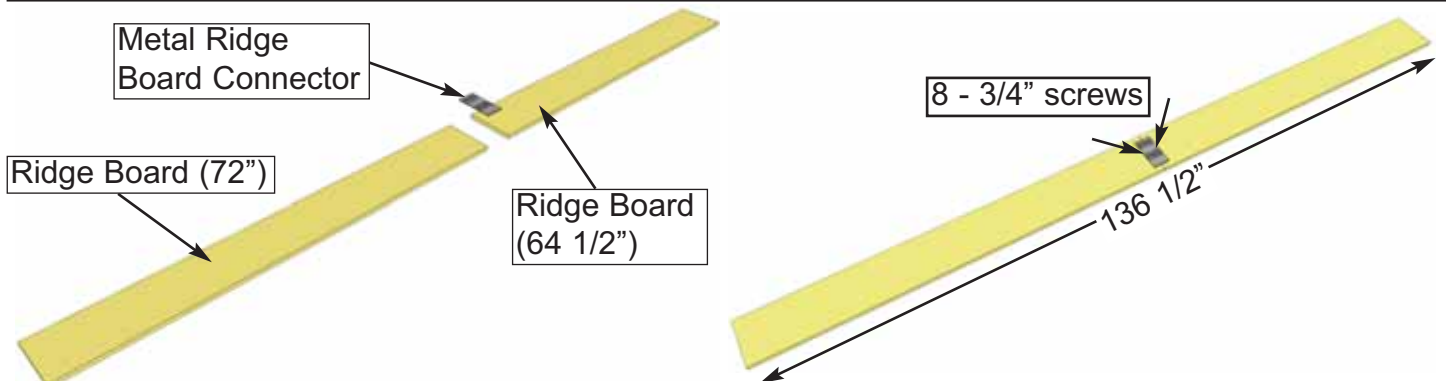

36. Locate 3/4" x 8 1/2" x 72" & 64 1/2" **Ridge Boards** and attach together with **Metal Ridge Board Connector** using 8 - 3/4" screws evenly on boards. Total Length when connected is 136 1/2". Complete two Ridge Boards.

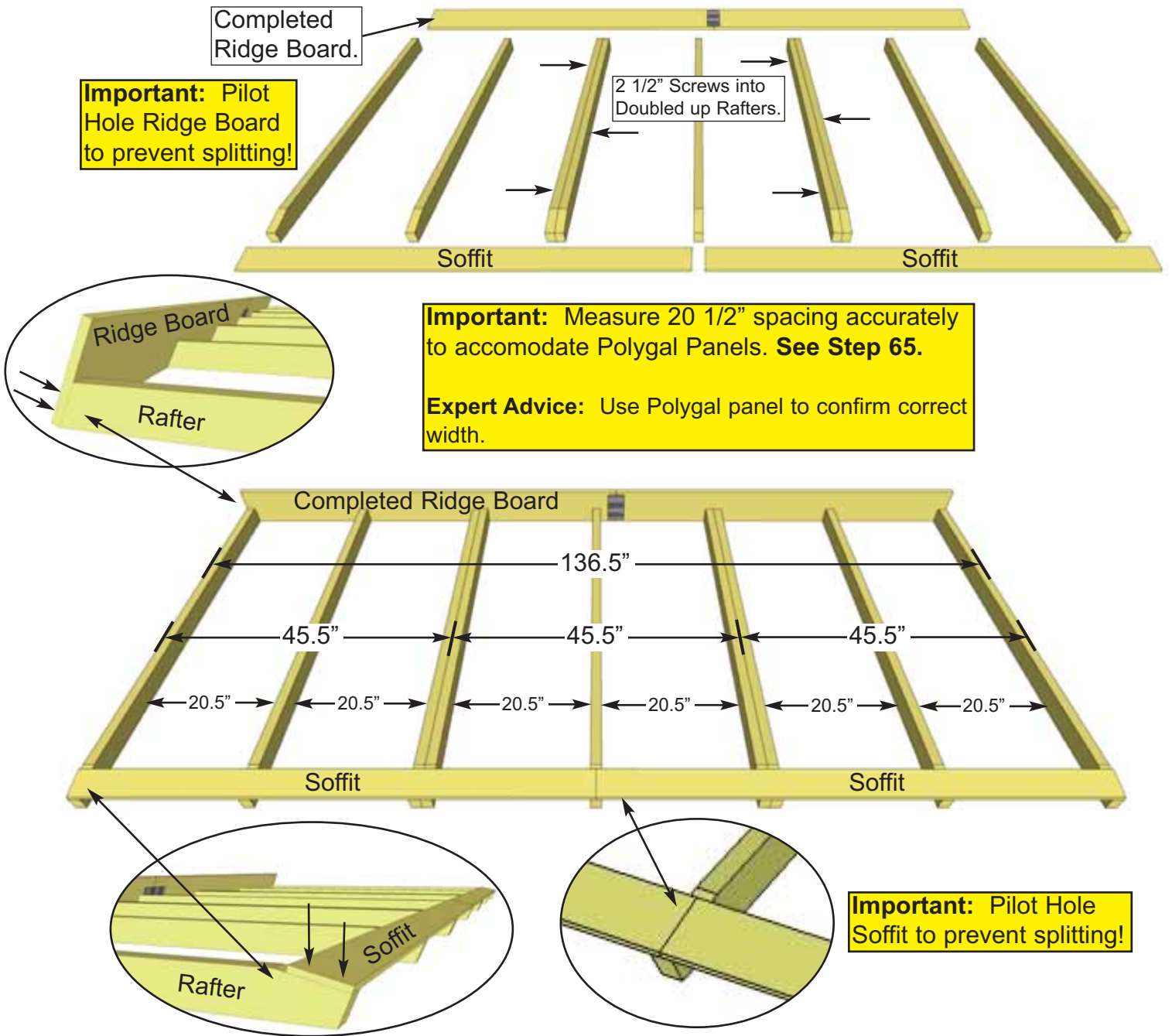

37. Lay out 9 **Rafters**, 2 **Soffits** and the completed **Ridge Board** from **Step 36** on level ground as shown. Double up Rafters as illustrated. Screw doubled up Rafters together with 3 - 2 1/2" screws. **Note:** completed rafter section will be flipped over in **Step 39**.

Attach completed Ridge Board to ends of both outside rafters with 2 - 2" screws per end. Measure and position interior Rafters as illustrated above. When positioned correctly, attach Ridge Board to remaining rafters with 2 - 2" screws /rafter end.

Important: Pilot Hole Ridge Board to prevent splitting.

Attach end of a 68 1/4" long Soffit Board flush to ends of outside rafters with 2 - 1 1/4" screws per rafter end. Complete both outside Rafter/Soffit connections first. Measure and position interior Rafters as illustrated above. When positioned correctly, attach Soffits to remaining rafters with 2 - 1 1/4" screws/rafter.

Important: Pilot Hole Soffits to prevent splitting.

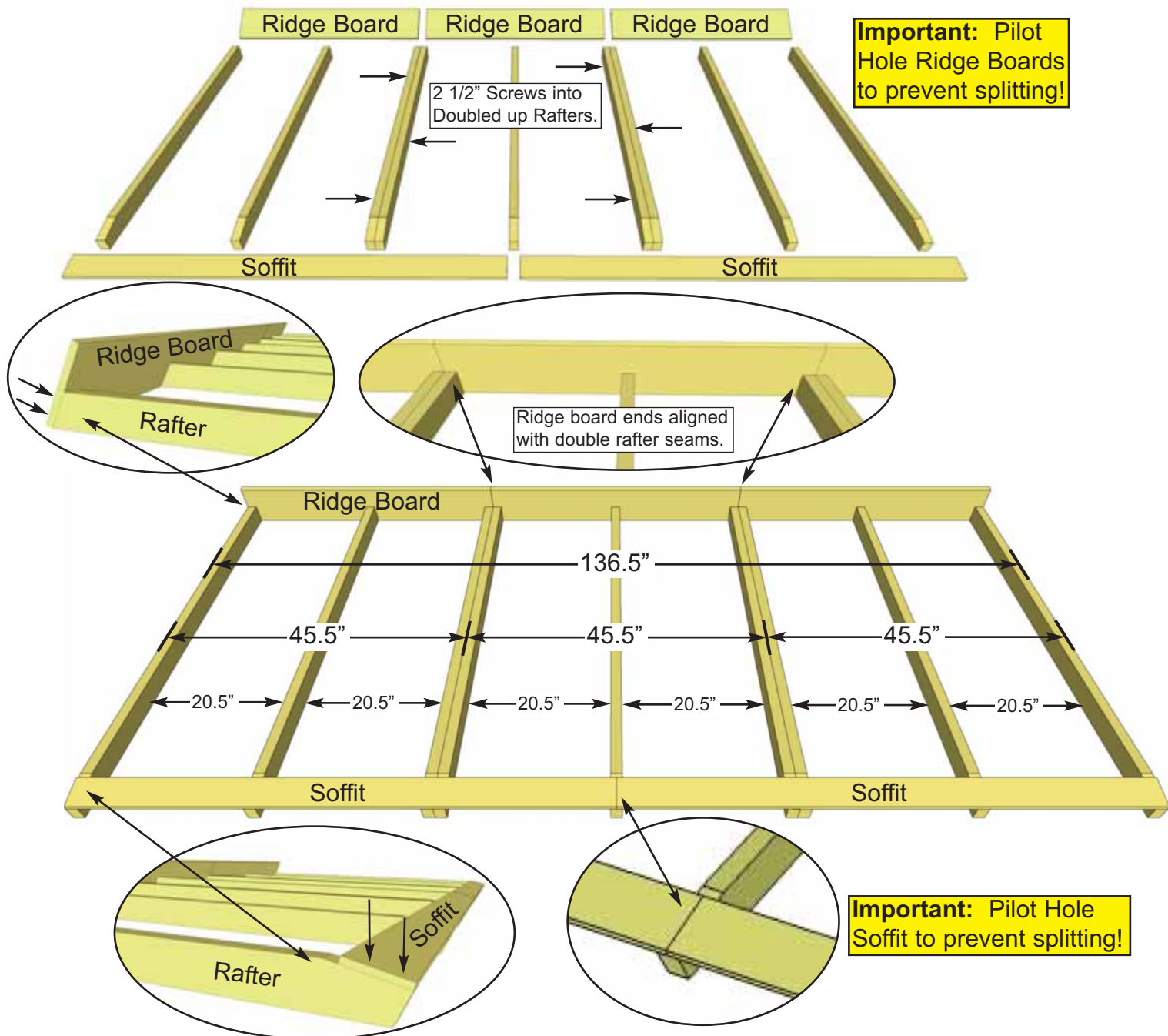

38. Lay out remaining 9 **Rafters**, 2 **Soffits** and 3 - 45 1/2" **Ridge Boards** on level ground as shown. Double up Rafters as illustrated. Screw doubled up Rafters together with 3 - 2 1/2" screws.
Note: completed rafter section will be flipped over in **Step 39**.

Attach Ridge Boards to ends of both outside rafters with 2 - 2" screws per end. Measure and position interior Rafters as illustrated above. When positioned correctly, attach Ridge Boards to remaining rafters with 2 - 2" screws /rafter end.

Important: Pilot Hole Ridge Boards to prevent splitting.

Attach end of a 68 1/4" long Soffit Board flush to ends of outside rafters with 2 - 1 1/4" screws per rafter end. Complete both outside Rafter/Soffit connections first. Measure and position interior Rafters as illustrated above. When positioned correctly, attach Soffits to remaining rafters with 2 - 1 1/4" screws/rafter.

Important: Pilot Hole Soffits to prevent splitting.

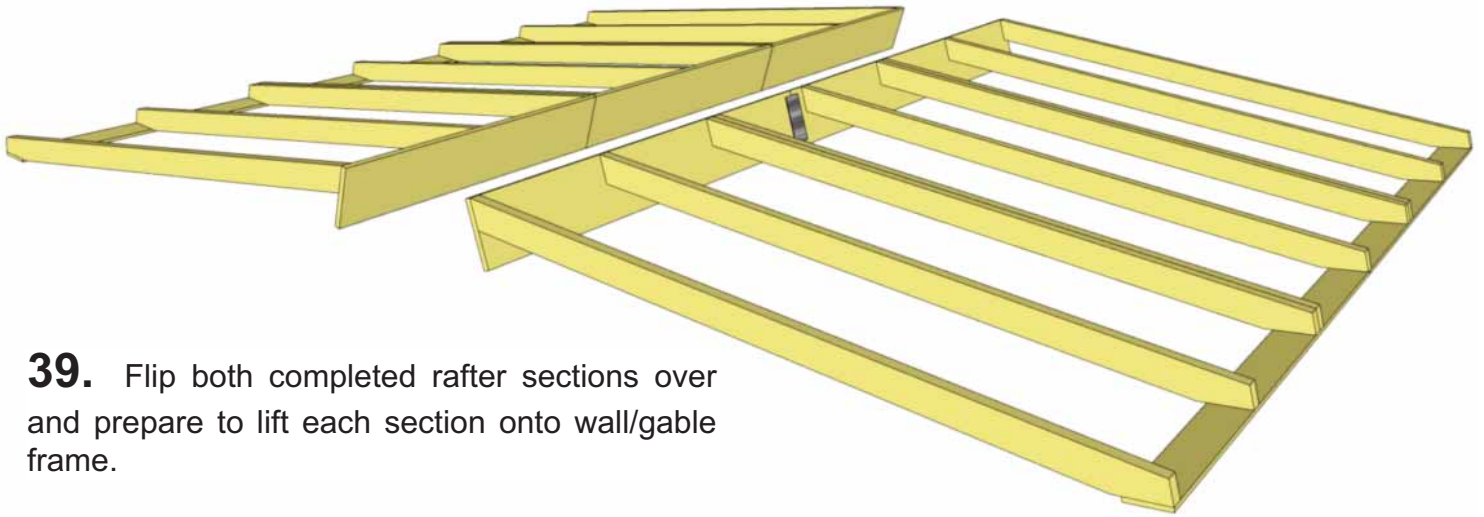

39. Flip both completed rafter sections over and prepare to lift each section onto wall/gable frame.

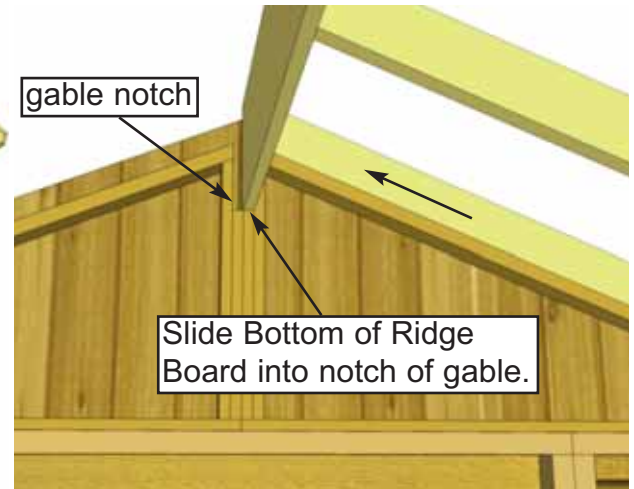
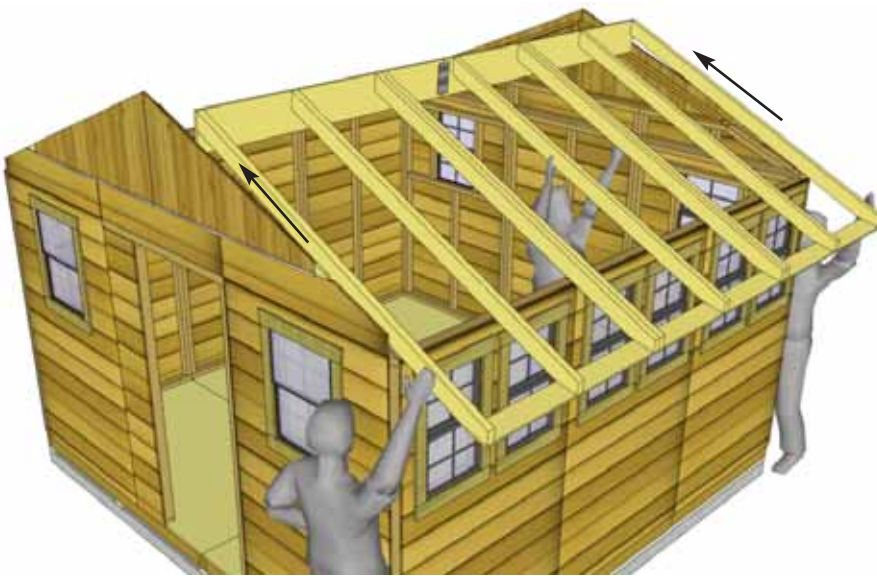

40. With the assistance of two helpers, slide first Rafter Section up onto gable framing until bottom of Ridge Board slips into gable notch. Position rafters so they sit evenly on Gable framing from side to side.

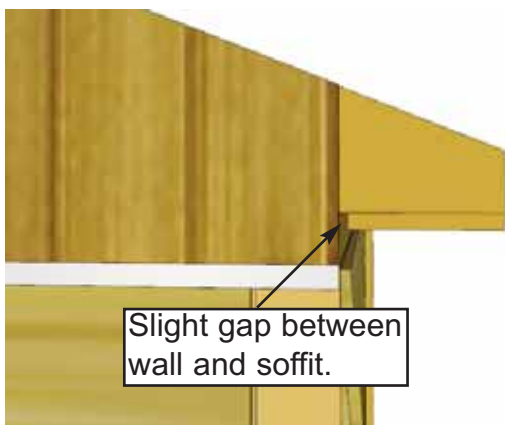

41. Where Wall and Soffit meet, a small gap may appear. Confirm all Rafters are resting on Top Plate.

42. Lift second Rafter Section up and place on Gable framing. Slide Rafter Section up on framing until bottom of Ridge Board slips into Gable notch. Soffit will sit approximately 1/8" away from wall as per **Step 41**.

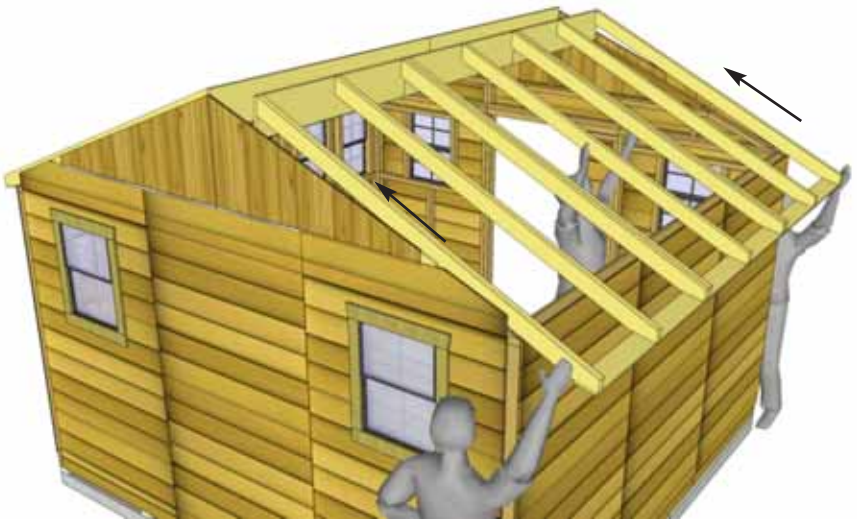

Ensure Ridge Boards are flush.

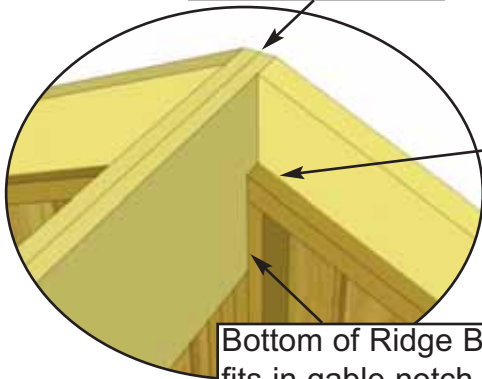

Bottom of Ridge Board fits in gable notch.

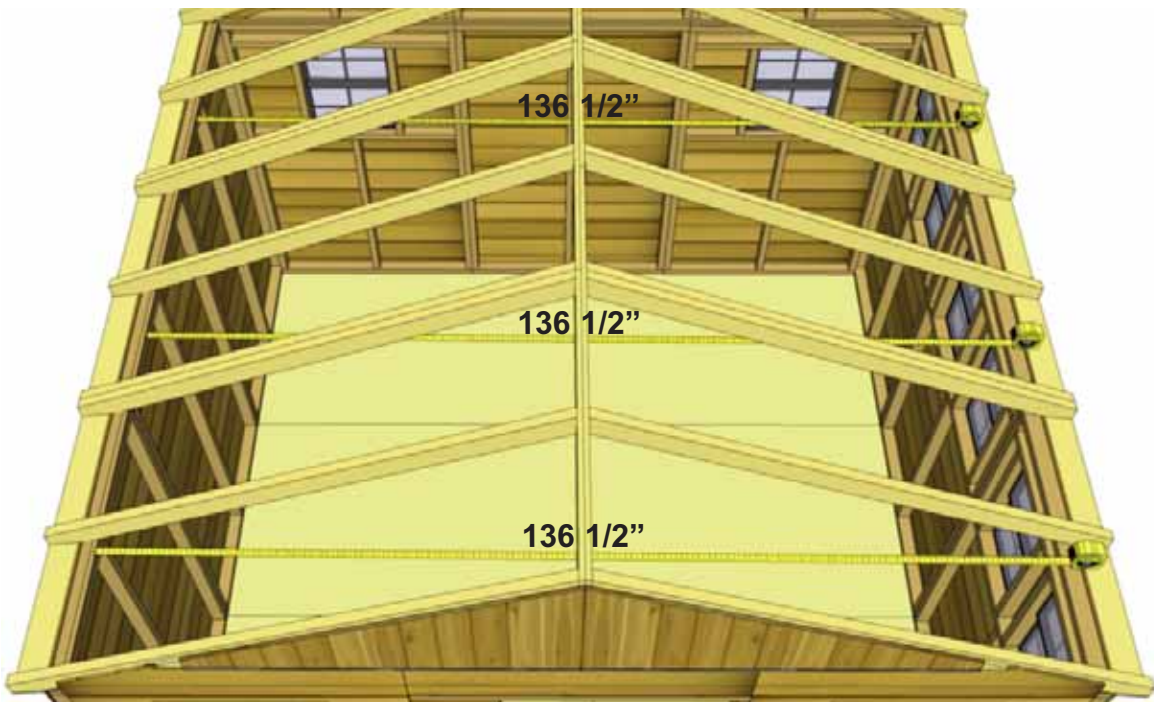

43. Take the inside-to-inside measurement between Top Wall Plates and Bottom Wall Plates at the front, middle, and rear of your shed. These measurements should each be approximately 136 1/2", but more importantly, if they are not within 1/4" of each other, your walls are not square.

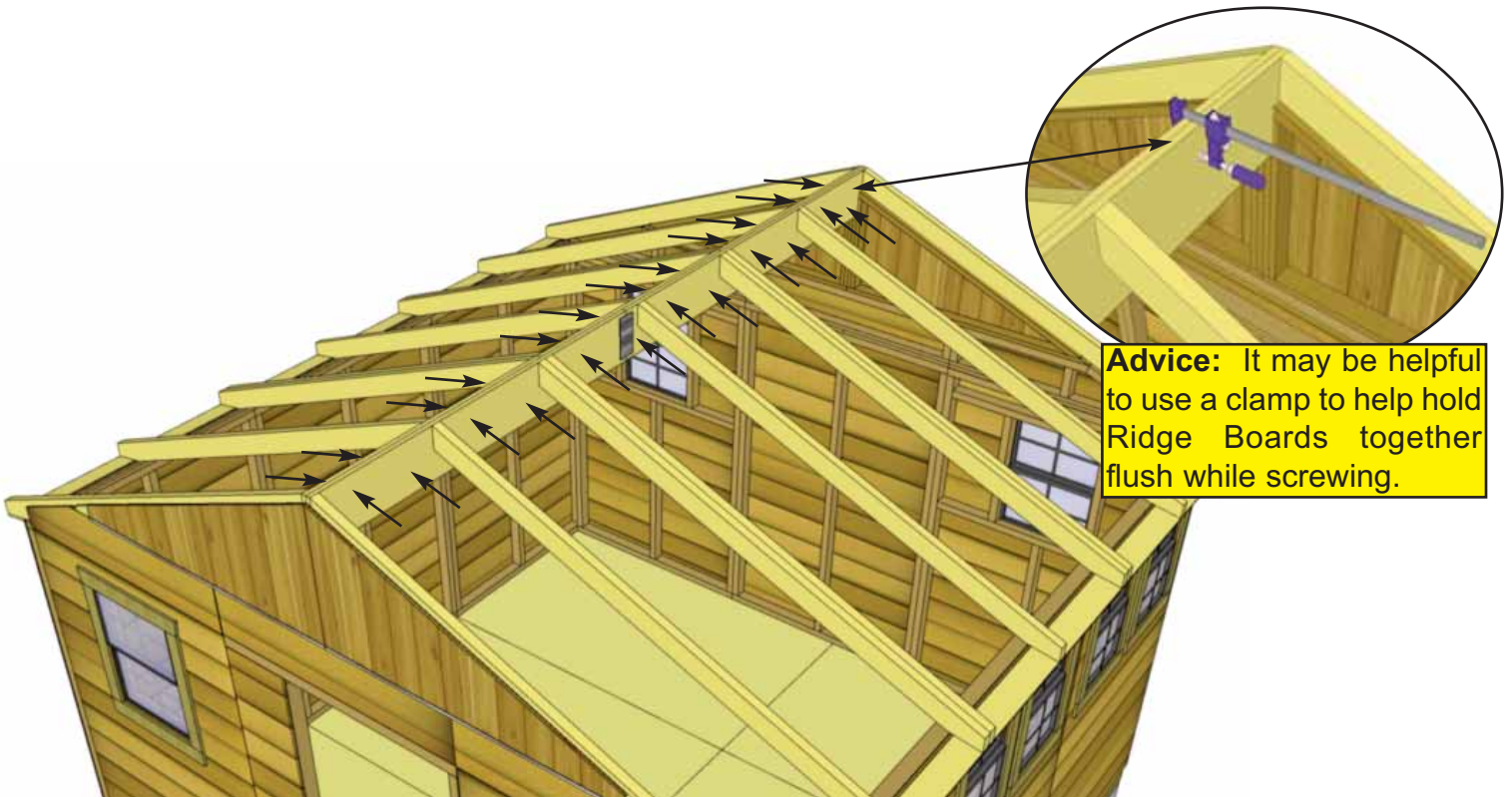

Advice: It may be helpful to use a clamp to help hold Ridge Boards together flush while screwing.

44. Where Ridge Boards meet, press together and secure with 12 - 1 1/4" screws per side. We recommend using a clamp to hold the Ridge Boards together flush while screwing. Stagger screw position vertically on Ridge Board to create a stronger connection. Complete both sides.
Important: if there is a gap between Ridge Boards, try pushing side walls closer together from outside. Walls should be 136 1/2" apart at top from inside of wall plate to wall plate as per **Step 43**.



45. With both Rafters Sections correctly aligned, secure Gable framing to both outside rafters with 8 - 2" screws per side at top and with 6 additional 2" screws into wall top plates at bottom.

Important: If Gable framing does not line up with Rafters, remove temporary 2" screws from gable framing. Re-align gable and secure with 8 - 2" screws total.

Place 1" below top edge of rafter.

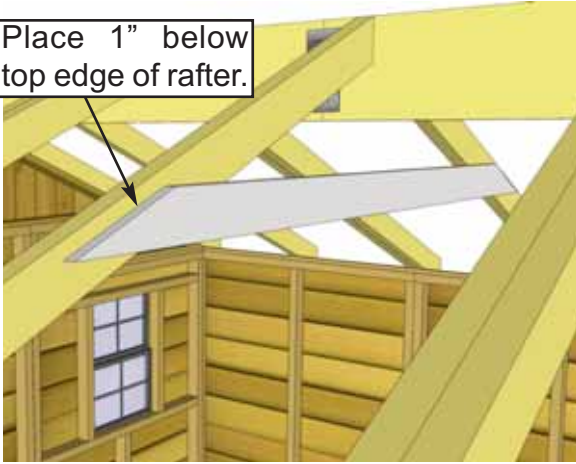

46. Start by attaching one **Gusset** onto the middle rafters as illustrated. Attach only 1 - 2" Screw per side for now. Before attaching the rest of the Gussets, recheck the inside-to-inside wall measurements as done in **Step 43**. Use a level to check for square. **Important: Pilot hole ends of Gusset to prevent splitting.**

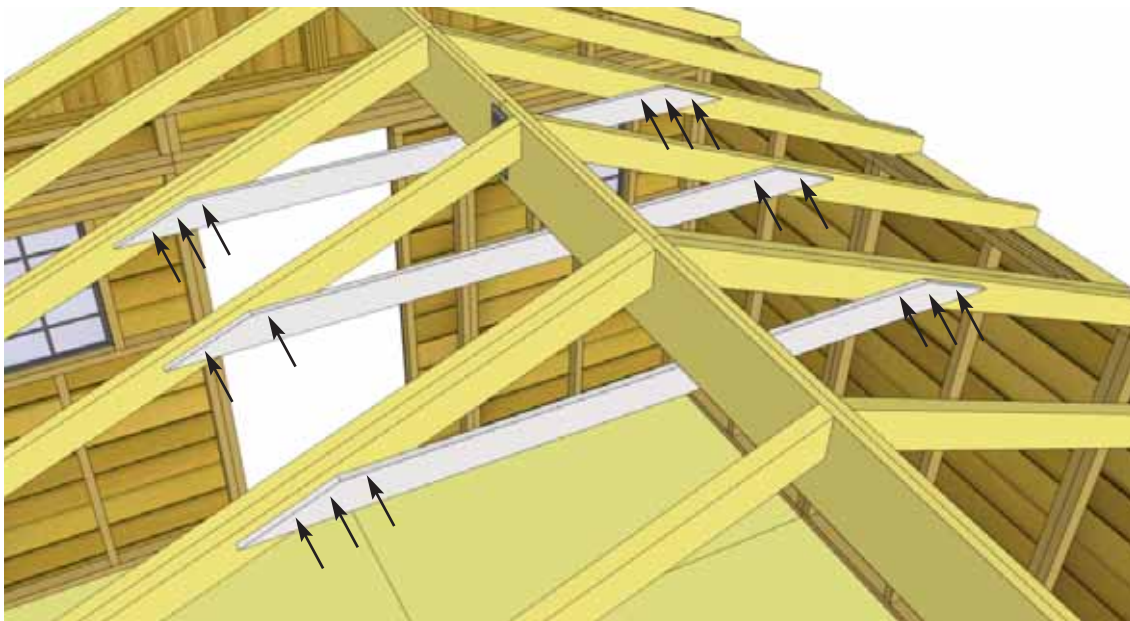

47. Once walls are confirmed to be square and plumb, attach the remaining 2 **Gussets** with 3 - 2" Screws into each end. Attach 2 - 2" Screws into each end of the middle Gusset which was partially attached in **Step 46**. **Important: Pilot hole ends of Gusset to prevent splitting.**

48. Attach all Single and Double Rafter Brackets where rafters meet Top Wall Plates inside of shed. Attach with 2 - 1 1/4" Screws and 2 - 2" Screws per **Single Rafter Bracket** and 6 - 2" Screws per **Double Rafter Bracket**.

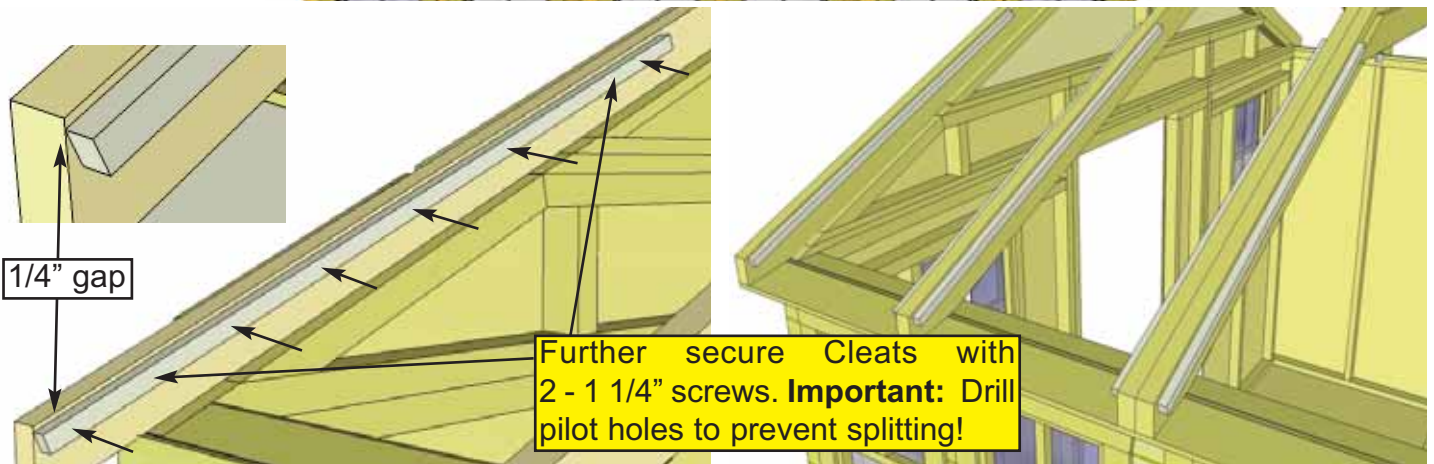
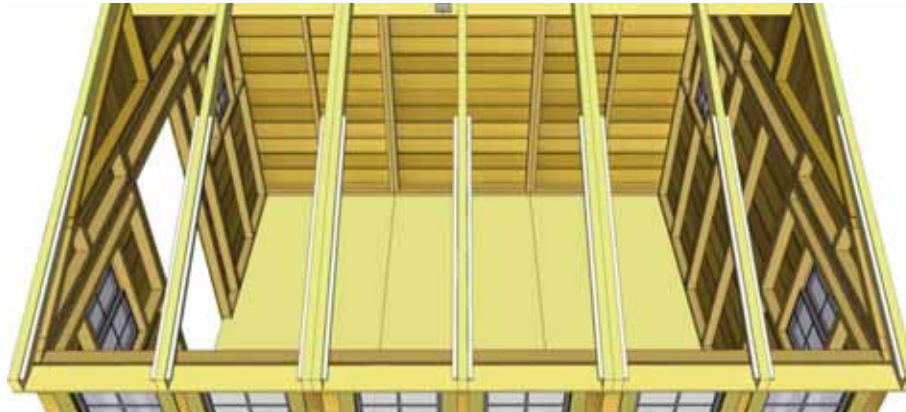
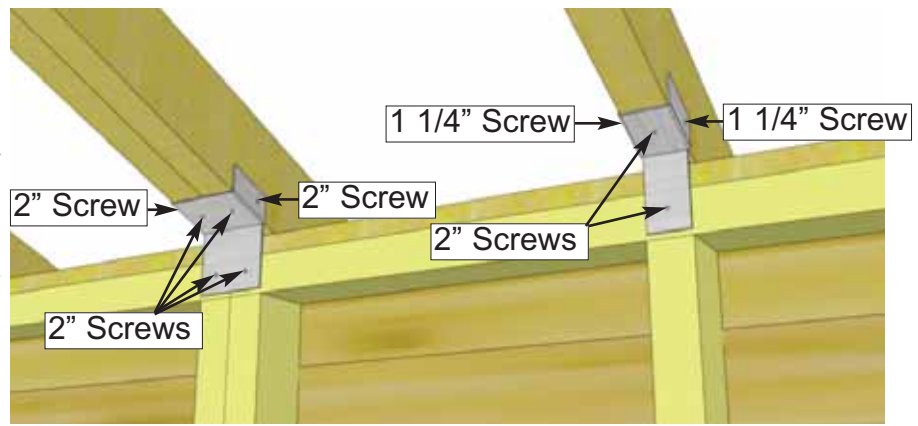

49. Position a 3/4" x 3/4" x 48" long **Polygal Support Cleat** on each Long Rafter flush to end and recessed 1/4" down from top of rafter. Nail to rafter using 6 - finishing nails. **Note:** Start nails in Supports on ground first. Further secure with 2 - 1 1/4" screws - see diagram above. Complete remaining 11 Polygal Support Cleats.

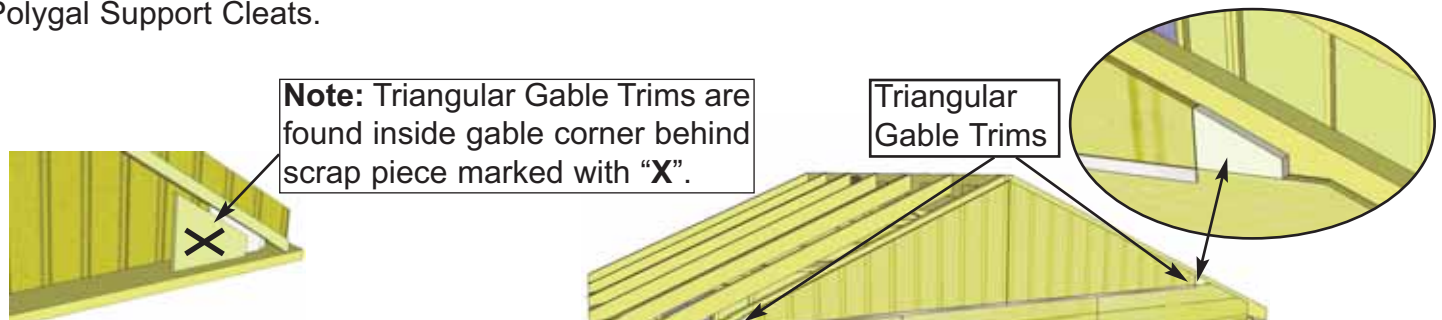

50. Position **Triangular Gable Trims (4)** in each corner of exposed cavity of Gable Wall. Use 2 finishing nails each to secure into rafter.

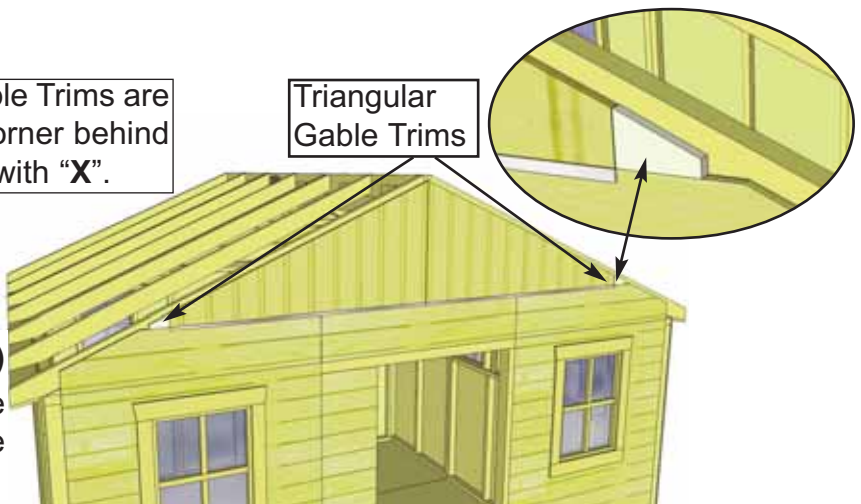

Roof Section

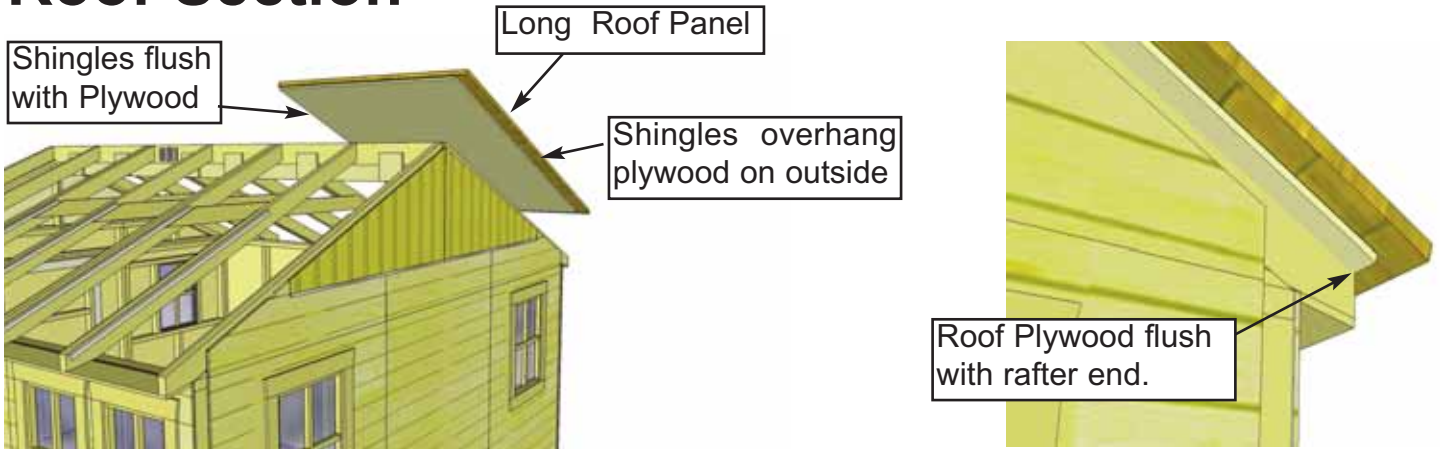

51. Identify all **Roof Panels**. There are 2 Outside Right, 2 Center and 2 Outside Left Roof Panels. The outside of the panels will have shingles overhanging the plywood. Starting with an Outside Long Cedar Shingle Roof Panel, lift up and place on rafters so Plywood is flush with end of Rafter.

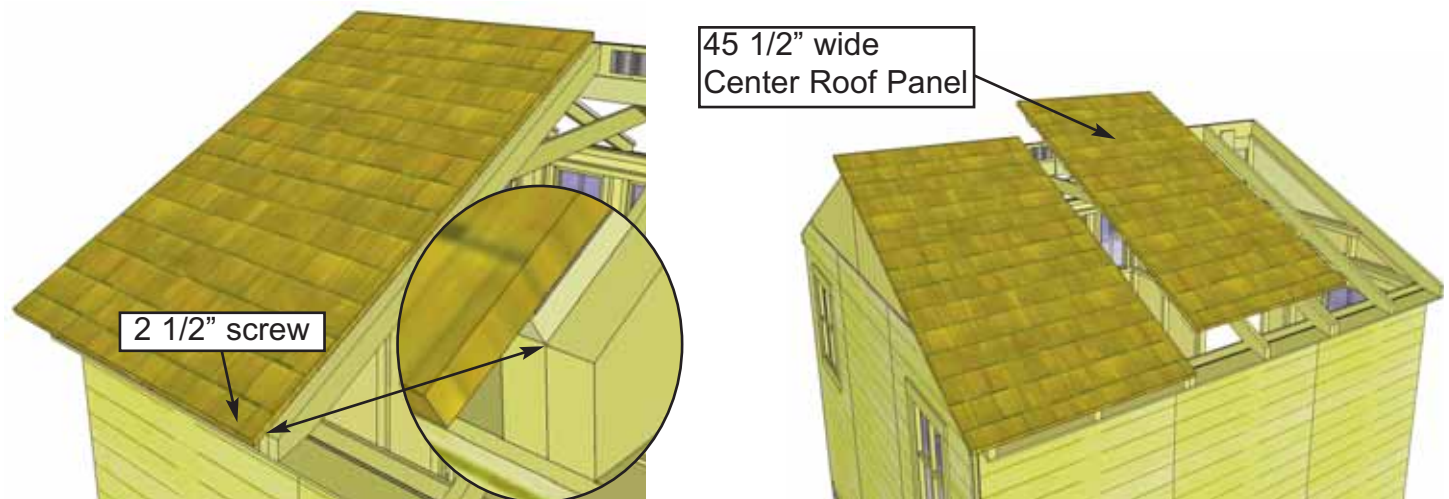

52. Position Panel so roof plywood sits evenly on doubled up Rafters. Screw Panel to Rafters through bottom row of shingles with 1 - 2 1/2" screw. Lift up and place a Long Center Roof Panel on Rafters. Center Panel will have plywood flush with shingles on both sides. Position evenly on Rafters.

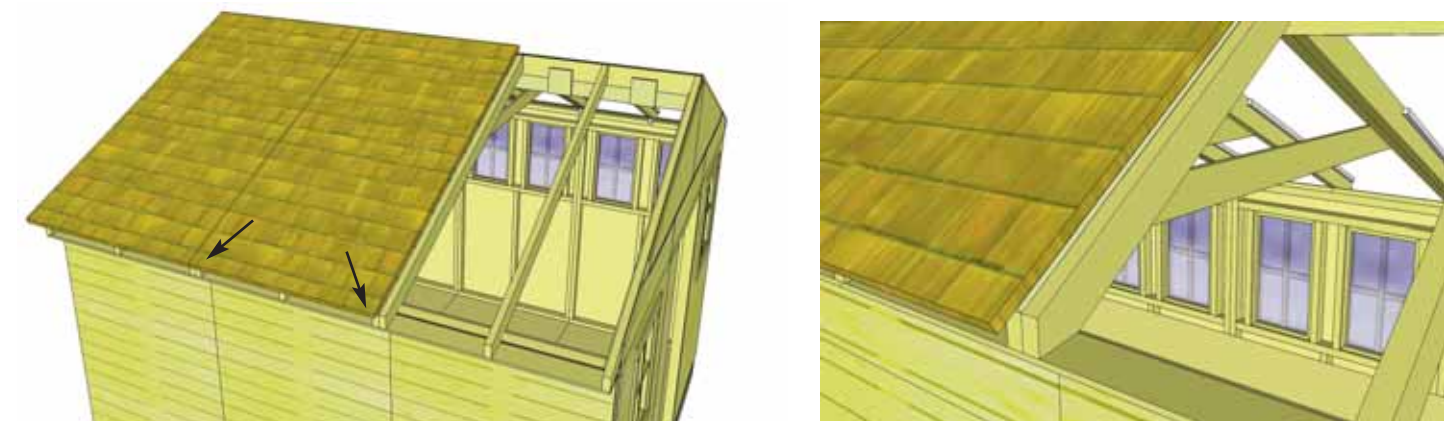

53. Position Center Roof Panel so plywood is flush with end of rafter as per **Step 51**. From side to side, make sure Roof Panel is sitting equally on rafters. When positioned correctly, screw down with 2 - 2 1/2" screws into outside lower shingles.

Shingles overhang plywood on outside

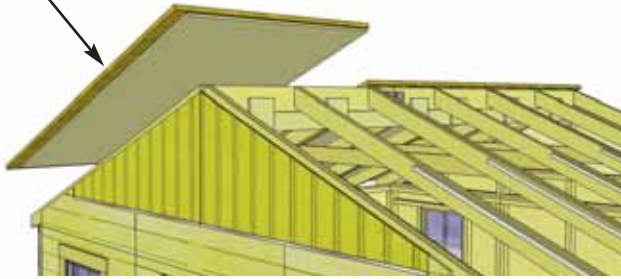

54. Lift up and place remaining Long Outside Roof Panel on rafters. Plywood on roof should be flush with end of rafter at bottom.

Polygal Side Short Roof Panel

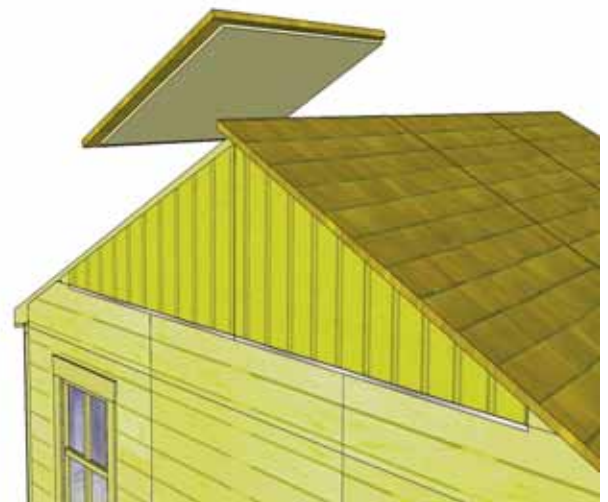
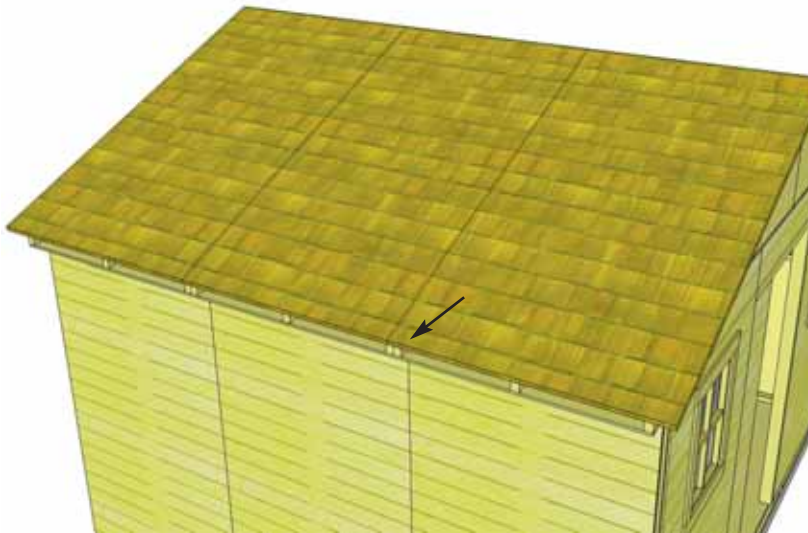

55. With Outside Roof Panel centered on rafter and aligned as per **Step 51-52**, screw down with 1 - 2 1/2" screw. Lift and Place Outside Panel for Polygal Side Roof.

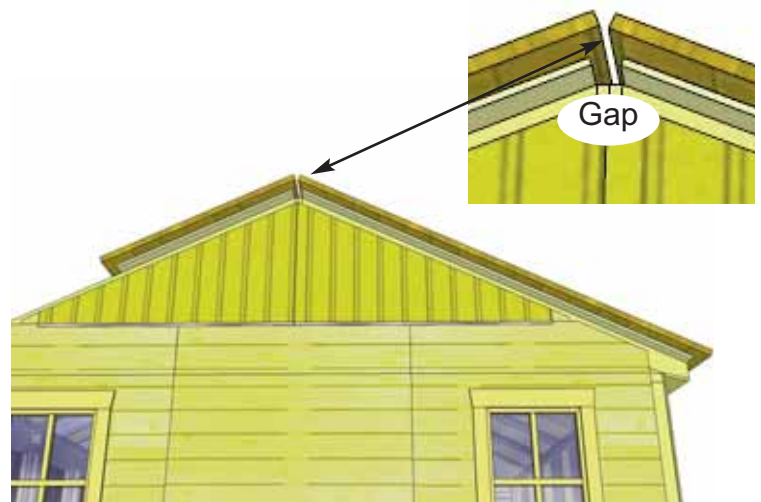

56. Position Outside Roof Panel equally on seam of doubled up rafters as per **Step 52**. Align Roof Panel at top so even with long panel at peak. Reach through opening in Rafters to attach. When positioned correctly, screw down with 1 - 2 1/2" screw in bottom row of shingles as illustrated above. **Hint:** work from inside of shed to position and secure Polygal Side Roof Panels.

57. Follow **Steps 52 - 55** for positioning and attaching Polygal Side Roof Panels. Align evenly at roof peak.

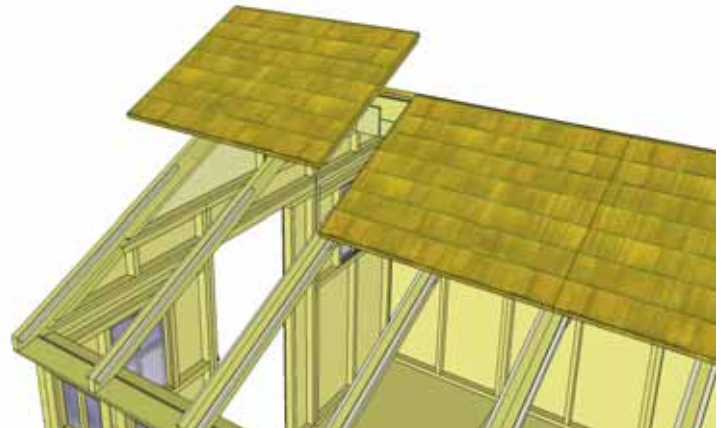
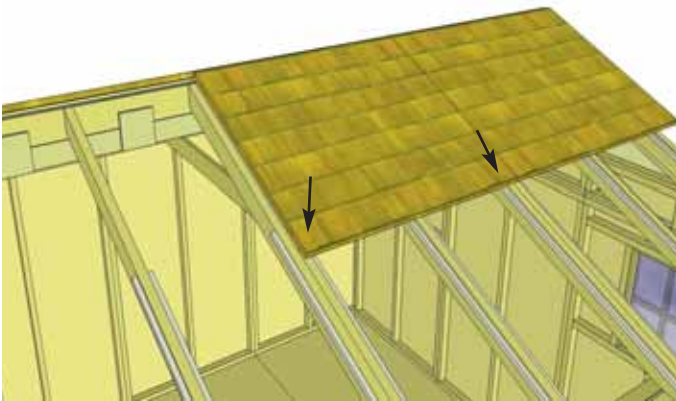
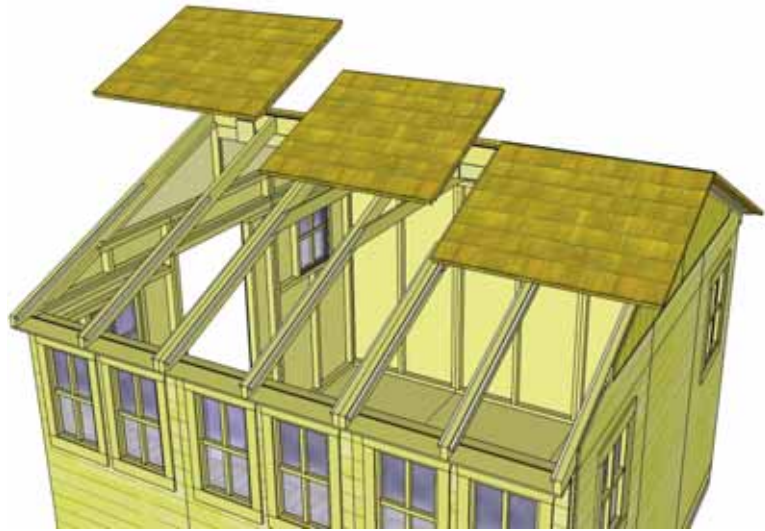

58. Work from inside the Sunshed when completing Polygal Side Roof Panels. Attach Center Panel with 2 - 2 1/2" screws as per **Steps 53**. Place remaining Outside Roof Panel into position.

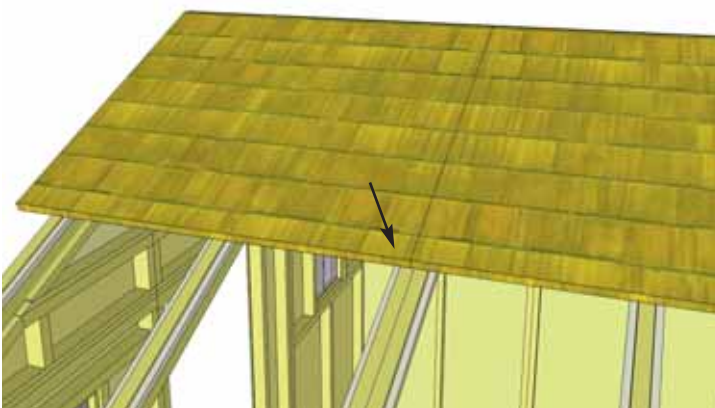

Completed Polygal Side Roof Panels

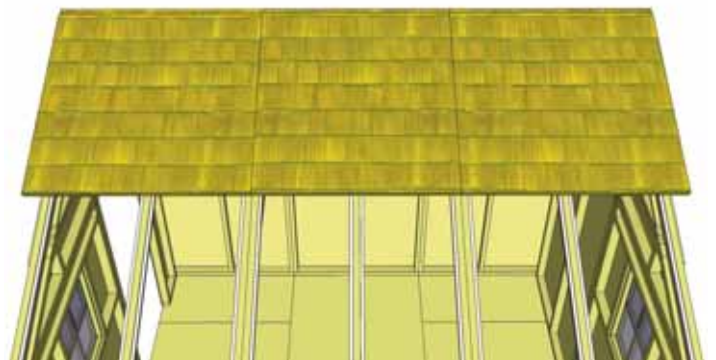

59. Position and attach Outside Panel.



60. Next, time to install **Filler Shingles** to hide roof seams of shed. Starting at bottom on Short Roof Side, push a Long Filler Shingle underneath shingles directly above it until ends are flush.

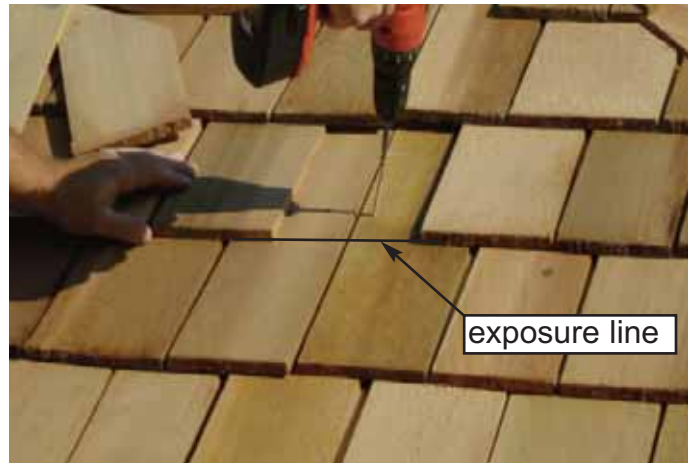

61. Screw first filler shingle down to rafters above the exposure line, using 1 - 2 1/2" screw per panel (2 in total). Make sure to screw into both rafters.



62. Slide in the next Long Filler shingle and attach as per **Step 61**. At the top, use shorter shingle to fit. Attach top shingle to roof with 2 shingle nails. Complete for all seams on Short and Long Roofs.

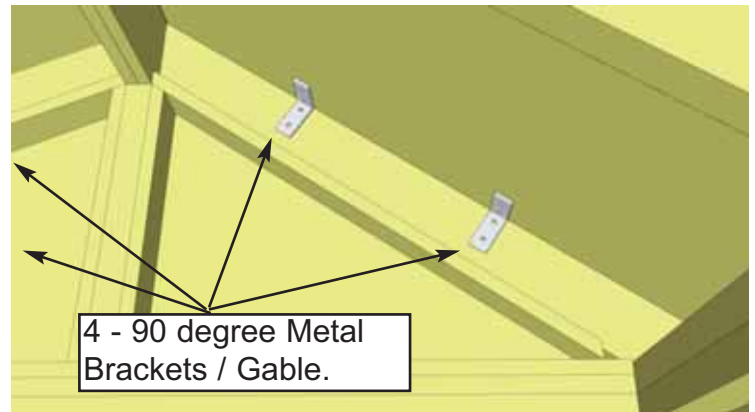

63. Position 2 - 90° Metal Brackets on plywood and outside rafters and secure with 4 - 1 1/4" screws. There are 4 ties per gable, 8 ties in total.

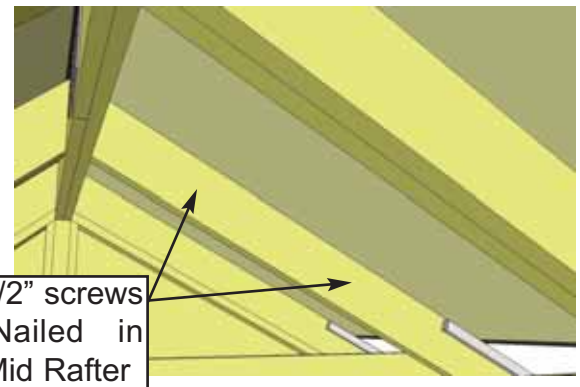
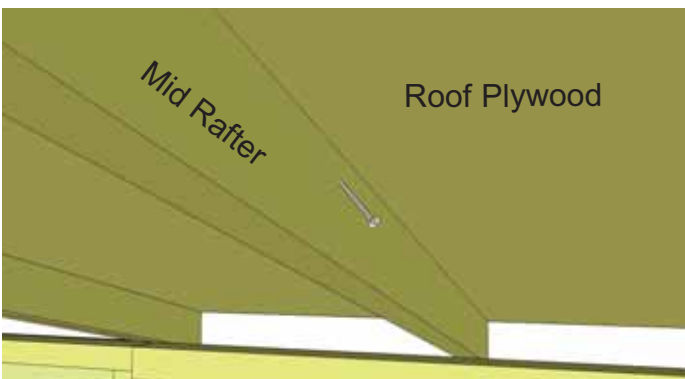

64. To further secure roof panels, from the inside, drill pilot holes on an angle into each Mid Rafter (3 per Rafter on Long Roof Side and 2 on Short Roof Side). Using 2 1/2" screws, secure rafters to roof plywood. **Hint:** have a helper push the roof panel down from the outside so plywood sits flush against the rafter when securing.

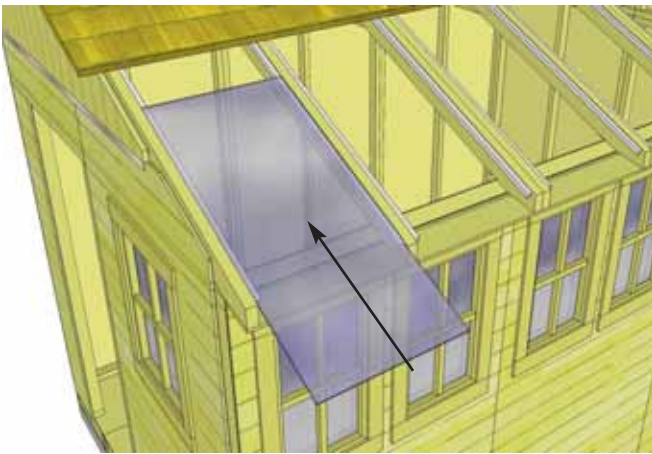

65. Installation of **6 Polygal Panels** is next. Start by removing protective plastic layer on each panel. Exterior/interior side of protective polygal film is printed on film, be sure to note the side and install accordingly. Slide panel up between rafters so it rests on Polygal Support Cleats. From the inside, carefully slide end of panel underneath plywood.

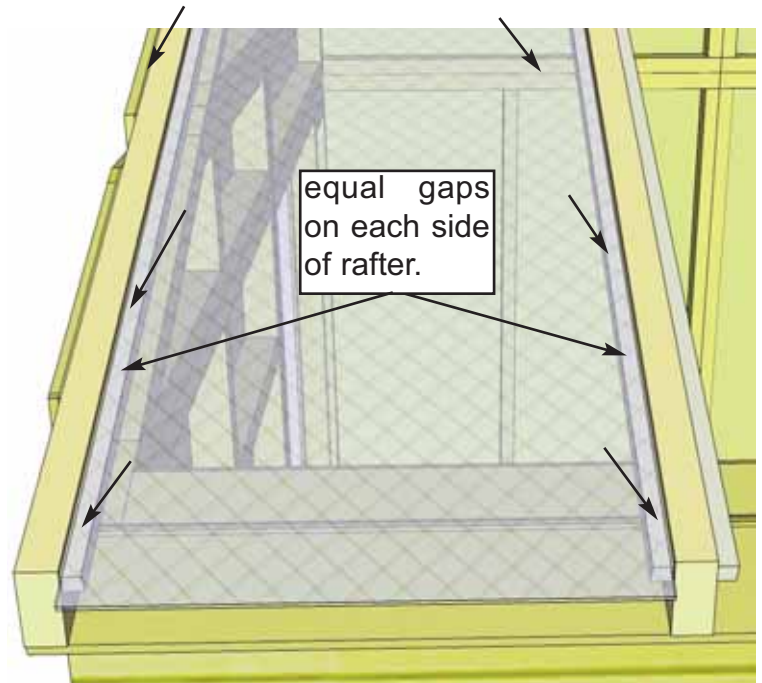

66. Position Polygal Panel with equal gaps between rafters and overhanging the end of rafters by 1". With 6 - 1" screws, secure panel to Polygal Support Cleats.

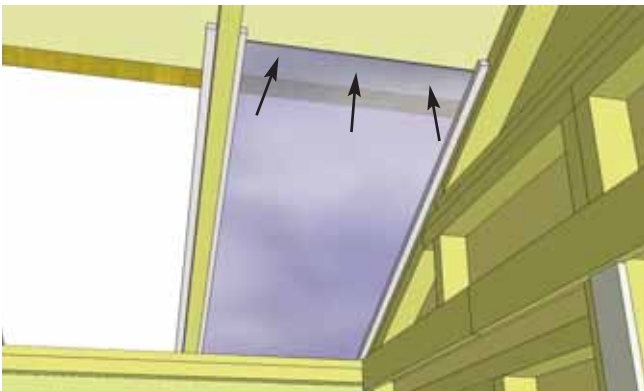

67. Use 3 finishing nails to secure Polygal Panel to underside of roof plywood.

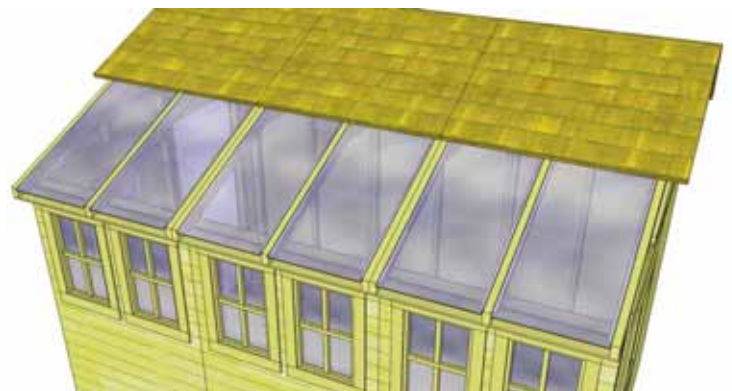

68. Complete installation of remaining Polygal Panels as per **Steps 65 - 67.**

69. With a Caulking Gun, apply Silicon down each side of rafter to seal gaps between rafters and Polygal Panels.

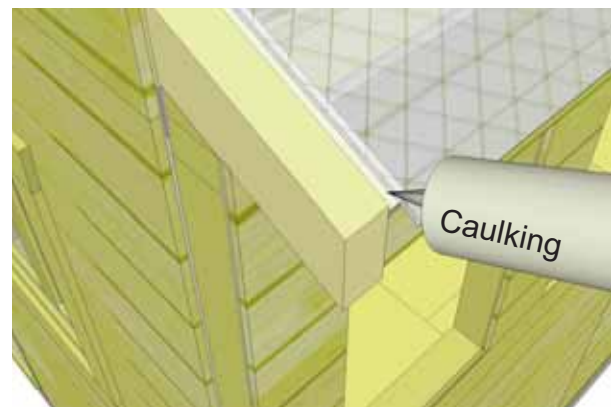

D. Miscellaneous Section

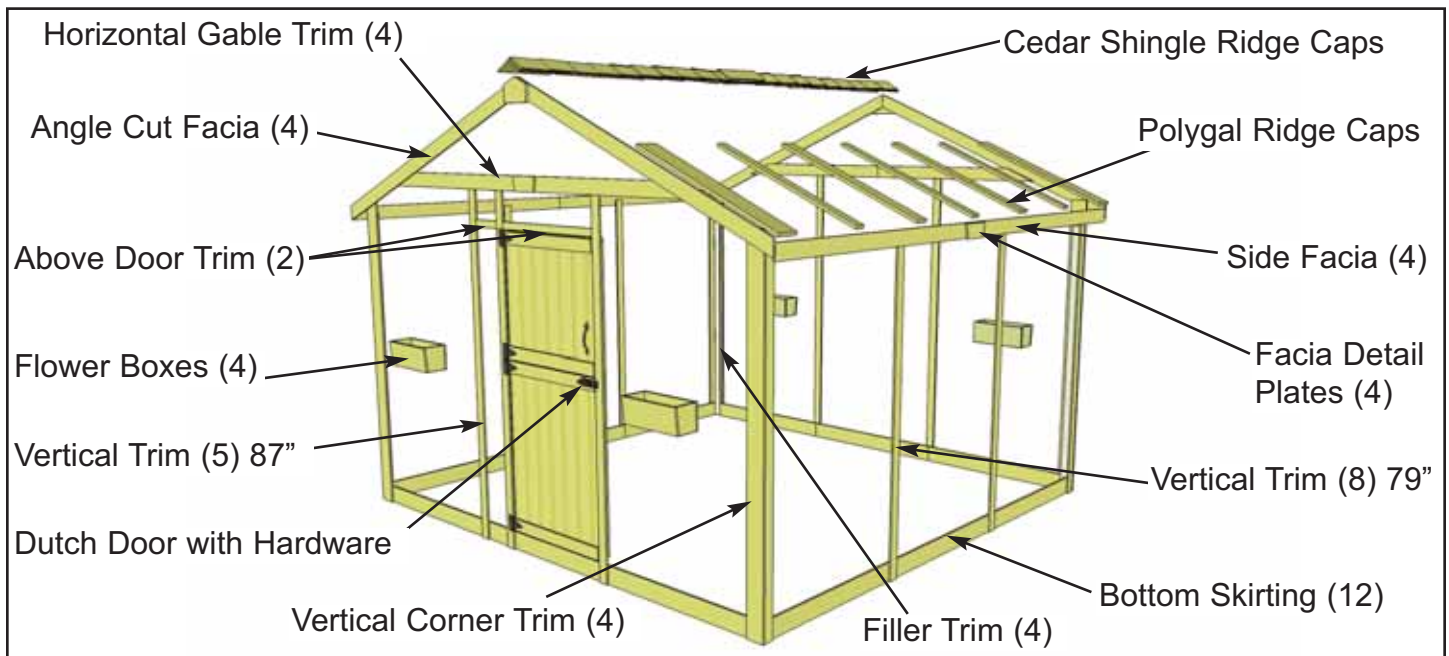

Expert Advice: When installing trim, sort pieces according to color and pieces that are most pleasing to the eye. Start with least visible side and use the least desirable pieces first. Install trim to most visible sides as your skill installing trim improves.

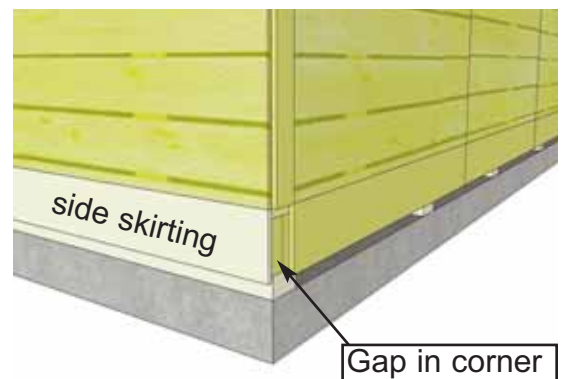

70. Attach **Bottom Skirting** around the base of the shed. Skirting will hide floor framing. Gaps on outside will be covered by Wide Trim pieces later. Start with front and rear skirting pieces first and attach with 4 - 1 1/2" finishing nails per piece.

71. Position 2 **Door Trims** (2 - 1/2" x 2 1/2" x 87") on each side of door opening. Right side will sit flush with Door Jamb. Left side will sit flush on edge of Narrow wall. Do a dry run with the Horizontal Gable Trim (**Step 90**) to determine vertical location of Trims. Attach with 8 - 1 1/2" finishing nails.

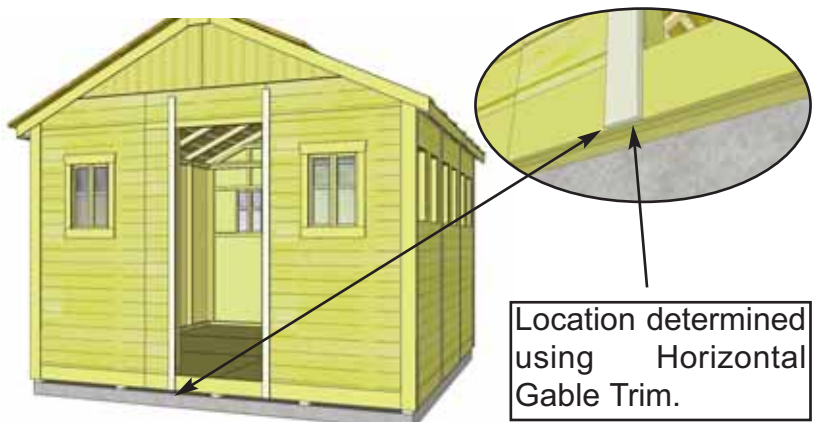

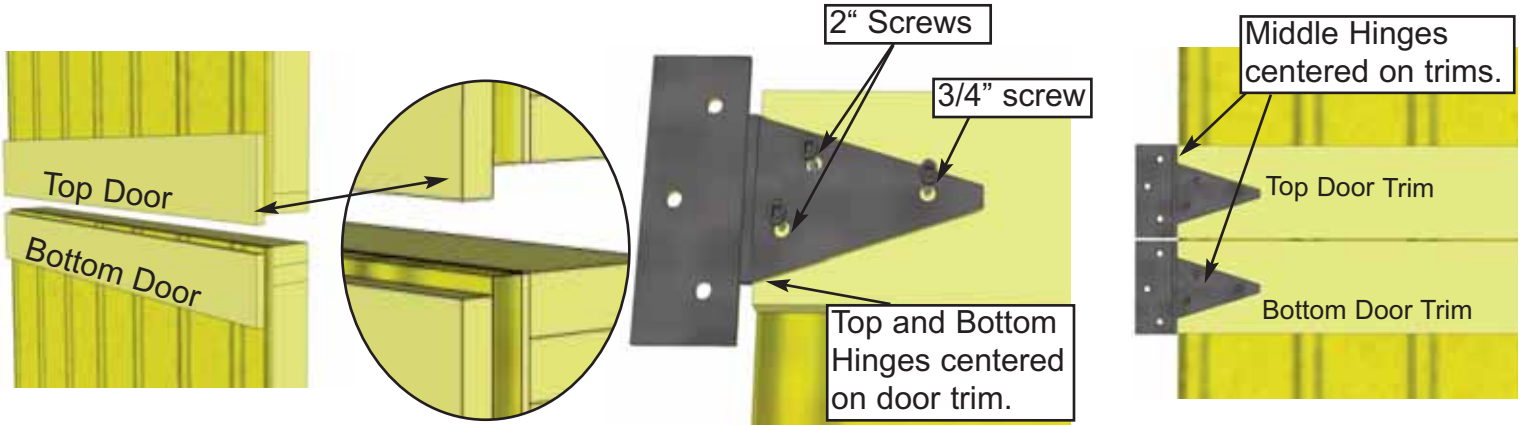

72. Attach Door Hinges to **Top** and **Bottom Dutch Door** sections. Top Door has trim overhanging door at bottom while bottom door has trim recessed slightly. Hinges should be centered on door trim with barrel nudged to end of trim. Use 2" & 3/4" black headed screws as shown above.

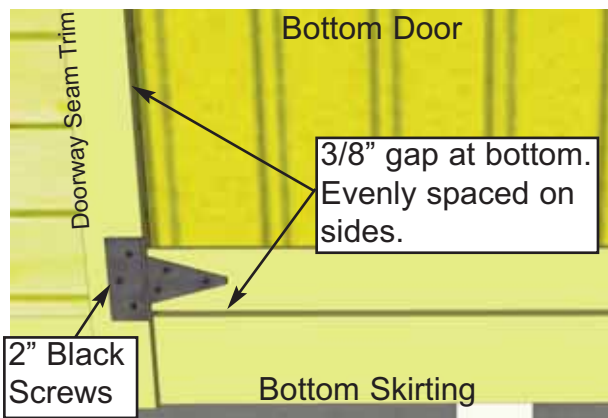

73. Place Bottom Dutch Door panel into position. Gap 3/8" on bottom, evenly space on sides, and attach hinge to doorway seam trim with 2" black headed screws. Use shim to help keep the door evenly spaced on bottom. One of the extra roof shingles (see parts list) can be used.

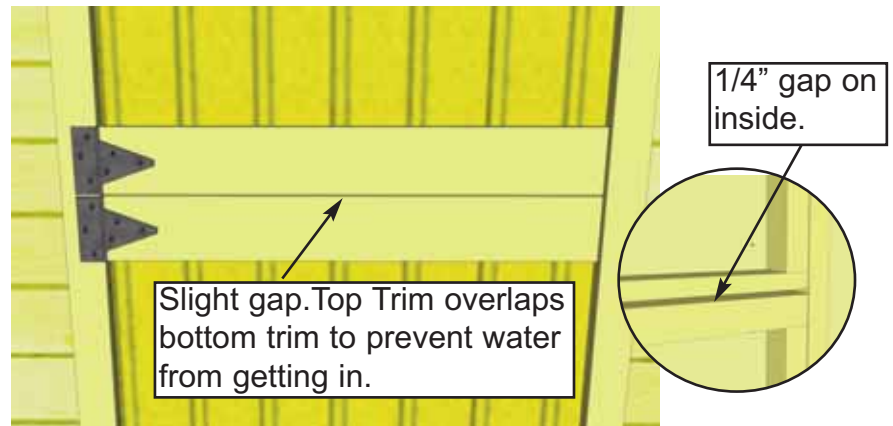

74. Place the Top Dutch Door Panel into place and gap top and bottom trims on the outside about 1/8" apart. On the inside, horizontal door frames should be about 1/4" apart. Use a shim once again to help you. Attach hinges to trim with 2" black headed screws provided.



Temporarily position Interior Door Stop to help align Interior Barrel Bolt.

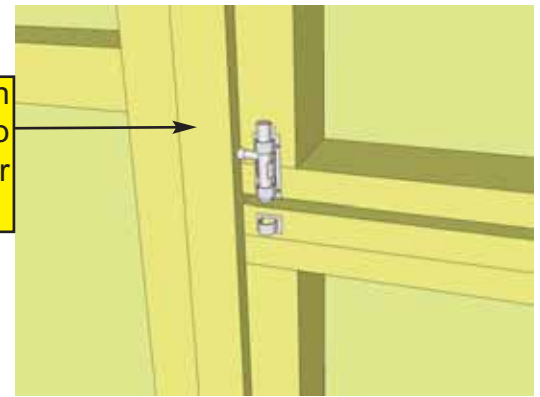

75. Attach **Door Handle**, **Exterior Drop Latch** and **Interior Barrel Bolt** to door. Handle is positioned on top door, Drop Latch on bottom door, and Interior Barrel Bolt (silver) on top door stud. Attach Black Drop Latch as illustrated above with 3/4" Black Screws. Note how female part of Drop Latch is positioned higher than male part. Do a dry run first to position Drop Latch correctly. **Important:** Drill pilot holes with 1/8" drill bit prior to securing to prevent wood from splitting.

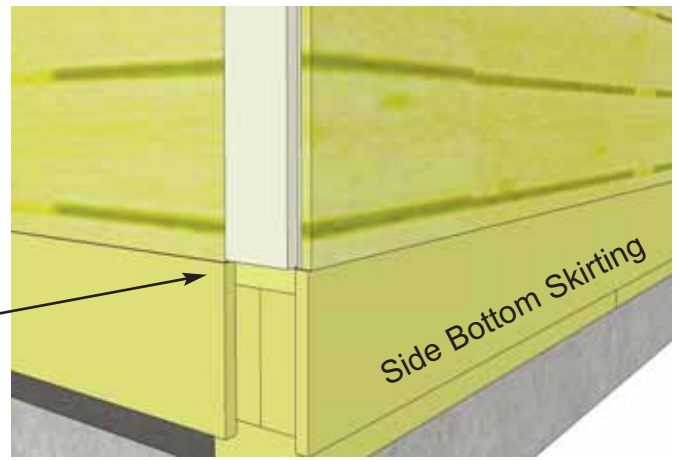

76. Attach **Filler Trim** (4 - 1/2" x 2 1/2" x 75") to front and rear walls in each corner. Attach with 8 - 1 1/2" finishing nails per piece. Strips are positioned flush with siding and bottom skirting.

77. Attach **Wide Corner Trim** and **Narrow Trim** in each corner. Wide Trims are 4 1/2" wide, Narrow Trims are 2 1/2" wide. Begin with narrow trim on side of shed, aligning tight underneath Soffit and even with front of filler trim. Wide Trim will cap Narrow, as shown in **Step 78**. **Note that trim may sit slightly below Bottom skirting when correctly aligned.**

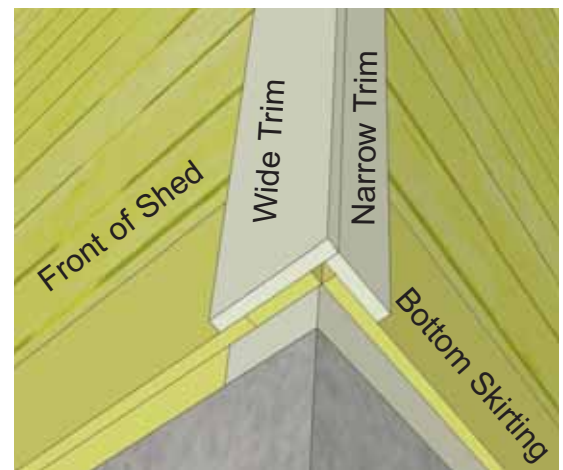
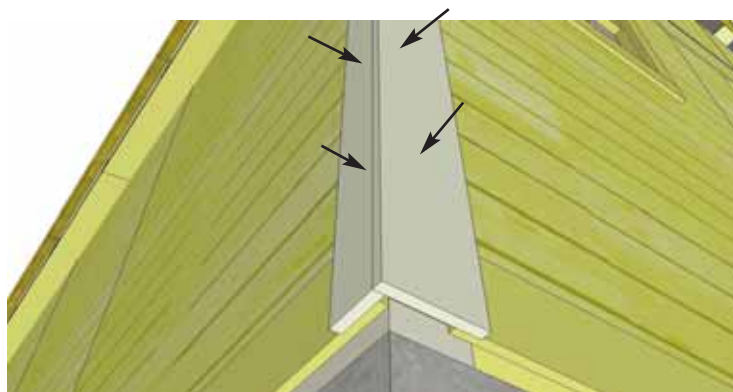

78. When correctly aligned, attach with 8 - 1 1/2" finishing nails per piece. Complete remaining Corner Trim attachments.



79. Attach **Narrow Wall Trims** around the Sunshed. Narrow trims are used where wall panels come together and leave a seam. **Note:** the Narrow Trim on the Short Wall side is only 79" long. Attach with 8 - 1 1/2" finishing nails per piece.

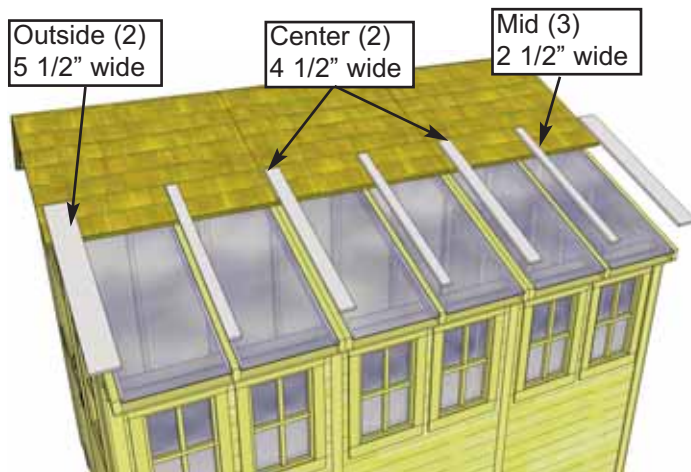

80. Locate all **Ridge Caps** for Polygal (3 Mid / 2 Outside / 2 Center). Starting from the outsides, position both 5 1/2" wide caps so the long edge with the pre-attached fascia cleat is aligned with plywood of roof, and Cap end slides under roof. When correctly aligned, attach Caps to center of outside rafter with 4 finishing nails. Use a straight edge to align Cap with Roof Plywood. **See below.**

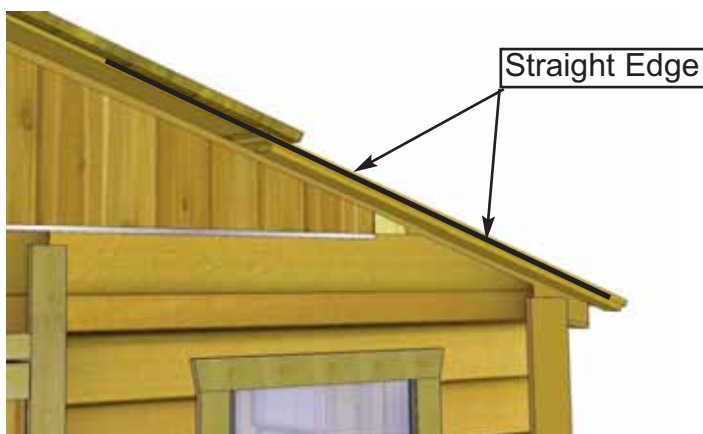
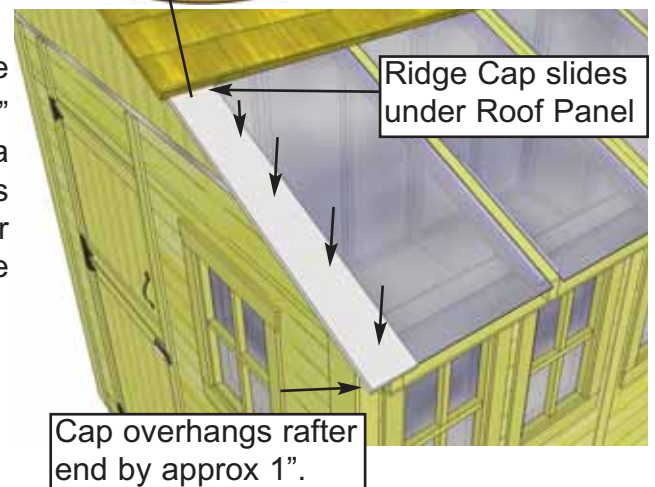

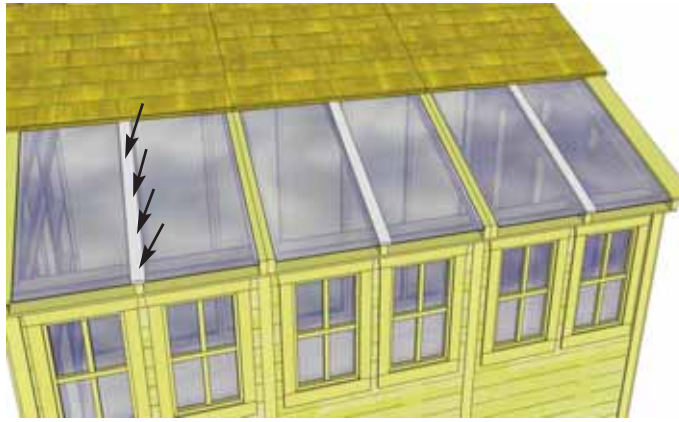

81. Position and attach Mid Ridge Caps, evenly spaced on mid rafters. Align top to bottom as per **Step 80**.

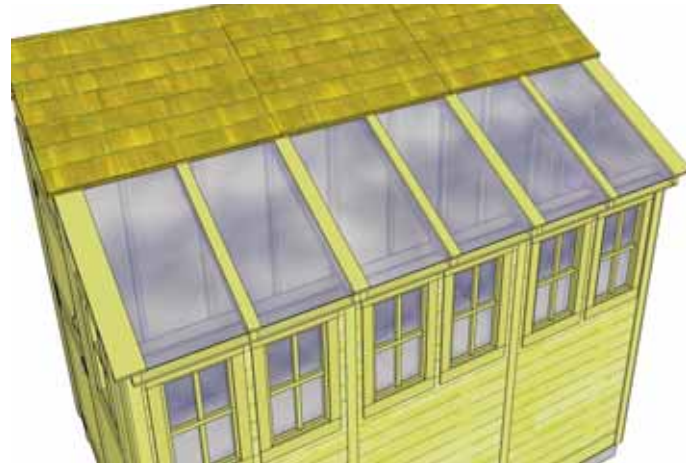
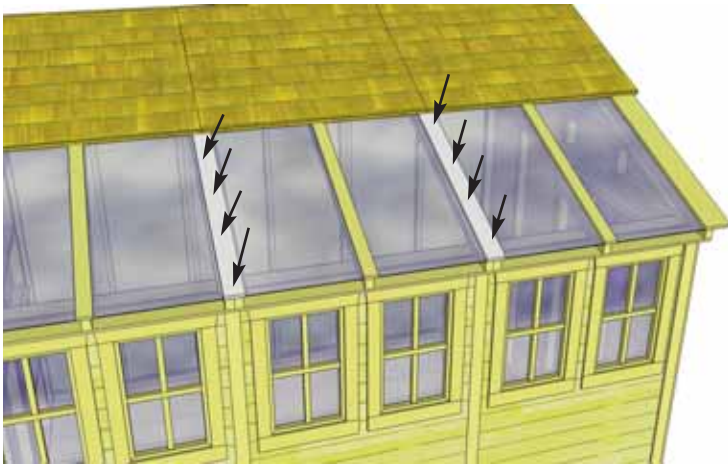

82. Align and attach remaining Ridge Caps (4 1/2" wide) over Double Rafters as per **Step 80**.



83. Attach **Facia Cleat (3/4" x 1 1/2" x 36 1/2")** centered on underside of Short Roof plywood, flush to edge. Attach **Facia Cleats (3/4" x 1 1/2" x 40")** to underside of Long Roof plywood, 1/2" from ends and flush to edge. Repeat this step on the rear side of shed. Fasten with 3 - 1 1/4" screws per piece.

Do a dry run, lining up Front/Rear/Side Facia to confirm positioning prior to attaching.



84. Attach **Front** and **Rear Facia** (angle cut on ends), to Facia Cleats on Long Roof Side, with 10 - 1 1/2" finishing nails per piece. Line up the 82 1/8" long Facia piece so Facia end lines up with Plywood and Rafter ends.

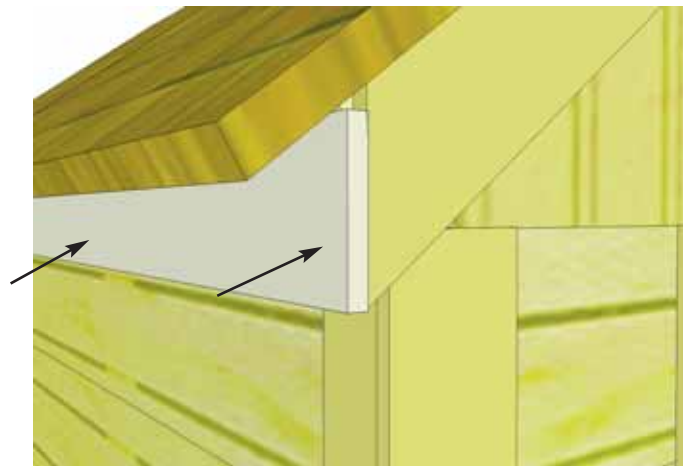

85. Attach **Side Facia (71 1/2" long)** to roof rafter ends. There are 2 Side Facia pieces per side. Secure with 8 - 1 1/2" finishing nails per piece. Side Facia will sandwich Front and Rear Facia.

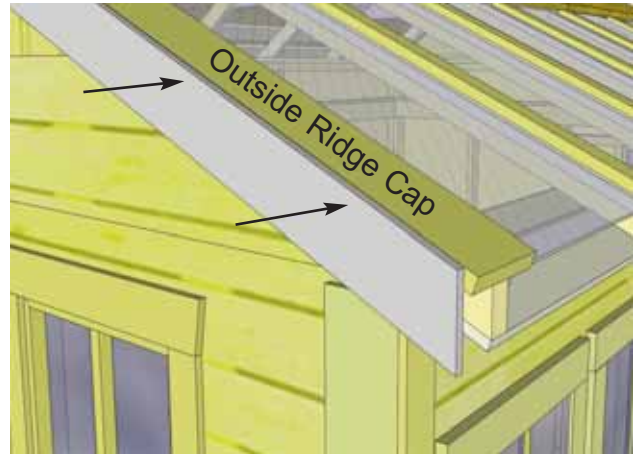

86. Attach remaining front and rear 82 1/8" long Fascia boards to Fascia Cleats on roof plywood and Outside Ridge Cap edge with 10 - 1 1/2" finishing nails and 2 - 1 1/4" screws. Use screws where Outside Ridge Cap and Fascia meet. Once again, Line Fascia up so it is aligned with rafter ends. Do a dry run with Front and Rear and Side Fascia to confirm correct positioning prior to attaching.

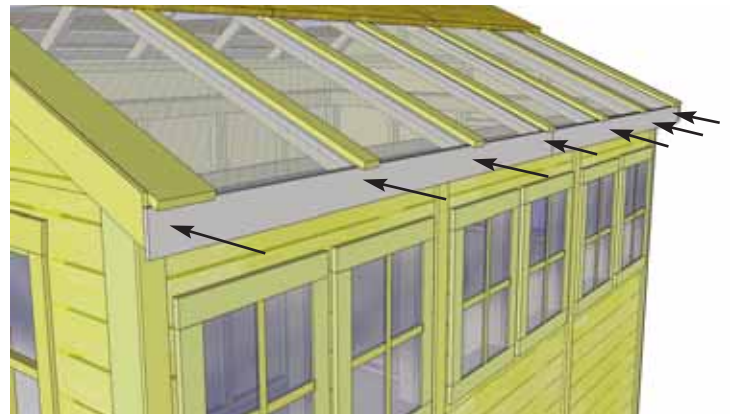
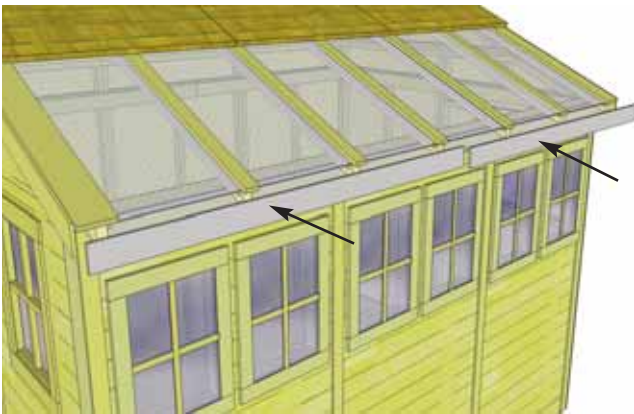

87. Attach remaining **Side Fascia** to roof rafter ends as per **Step 85**.

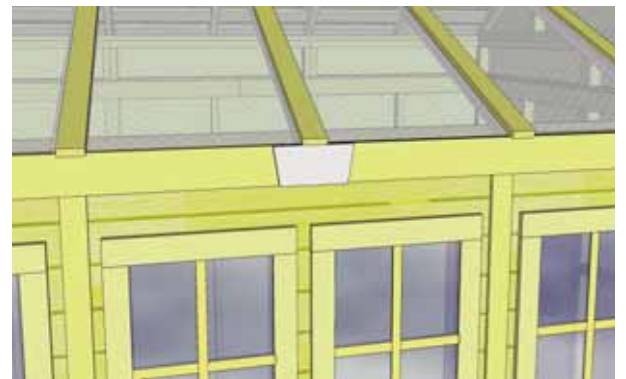

88. Attach **Fascia/Trim Detail Plates** and **Pentagon Plates** to cover seams where Fascia Trim pieces come together. Secure each with 4 - 1 1/2" finishing nails.



89. Attach both the **Horizontal Door Trim (32")** with 4 - finishing nails, and **Horizontal Narrow Wall Trim (8")** with 2 - finishing nails.



Angle cut on 1 end

90. Locate **Horizontal Gable Trims** for both front and rear of shed. Position equally over gable and wall seam.

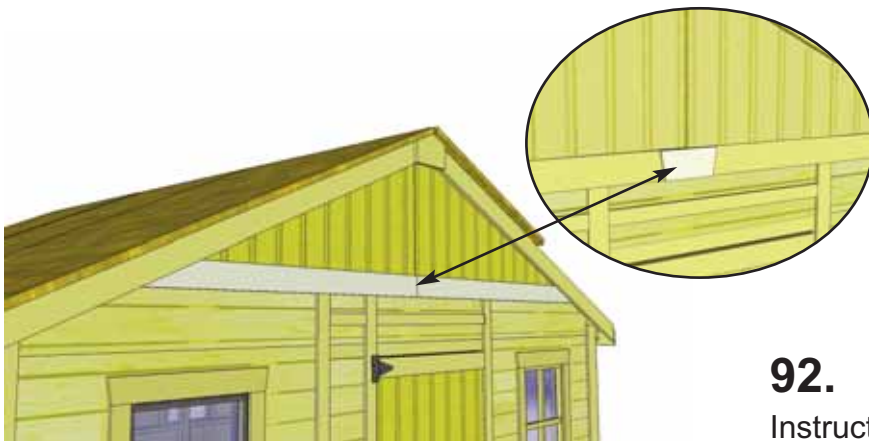

91. Use 8 - 1 1/2" finishing nails per piece to secure. Complete Rear. Attach **Facia Detail Plates** over Horizontal Gable Trim seam and attach with 4 - 1 1/2" finishing nails.



92. Assemble **Flower Box Kit** with Assembly Instructions included on Page 43. Position completed Flower Box below bottom of window trim and secure with 2 - 2 1/2" screws. Screw from inside of box into the center wall stud. Attach second screw 2" underneath first screw and once again into the wall stud. Install Flower Box Kits underneath each window.

Alternate Ridge Cap Seams (Offsetting angle cut at peak)

Important- Butt (thick) end of Ridge Cap will be facing towards the outside of shed.

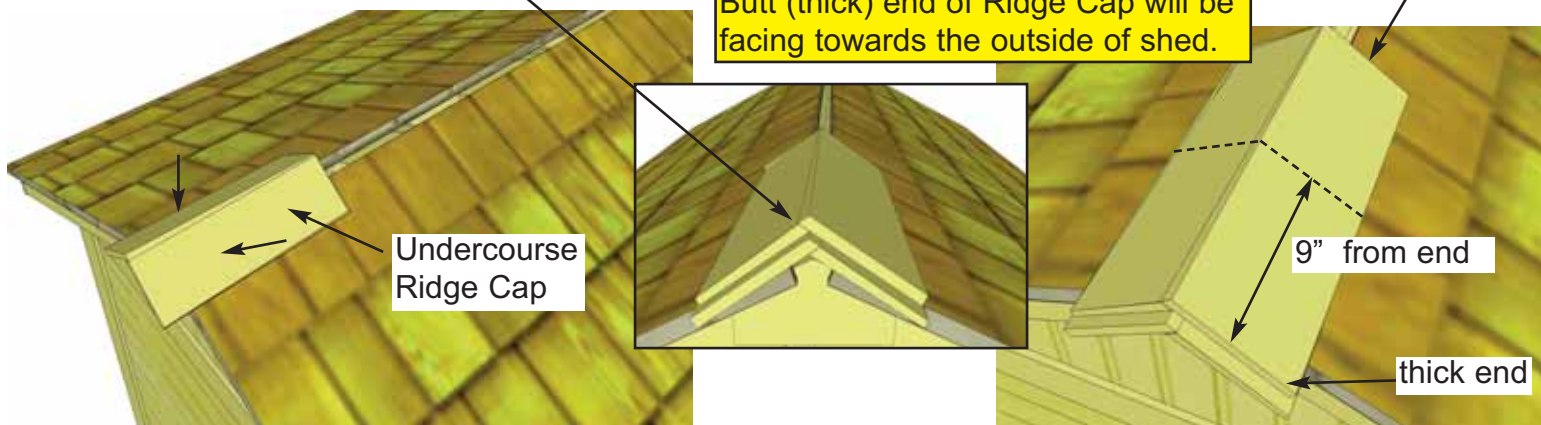

93. Place First Roof Ridge Cap (Lower Grade Undercourse Ridge Cap) on roof peak overhanging shingles by approximately 1". Attach with 2- 1 1/2" Shingle Nails 9" from end. Place 2nd Ridge Cap 1" back from 1st cap. Attach with 2 - 1 1/2" Shingle Nails 9" from end. Alternate each Ridge Cap as you proceed.

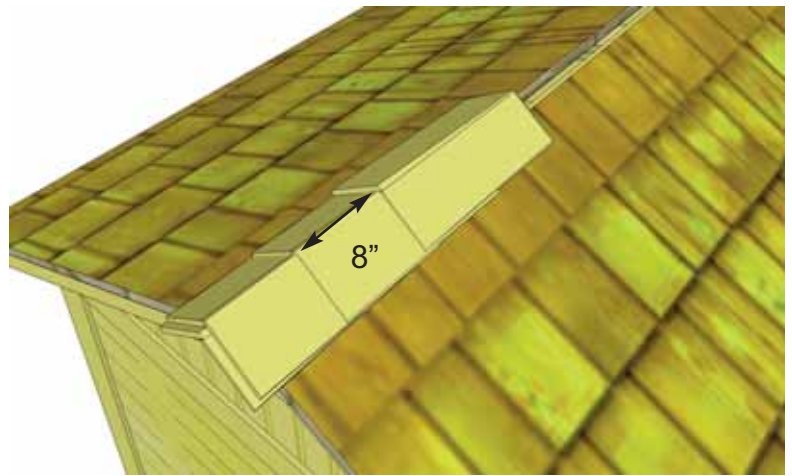
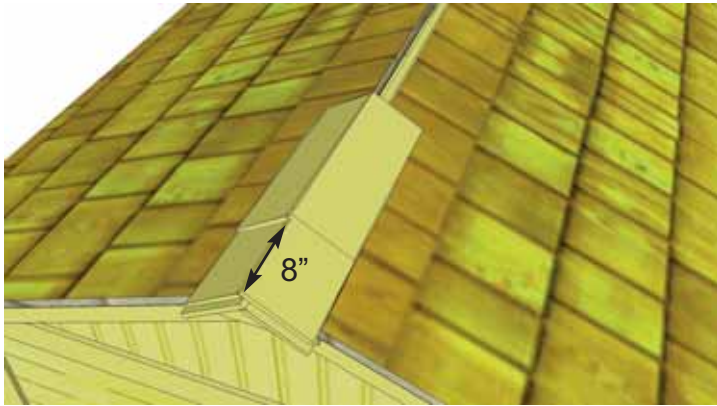

94. Place 3rd Ridge Cap 8" back from 2nd. (enough to cover shingle nails). Attach 3rd Ridge Cap down as per **Step 93**. Continue to position and attach Ridge Caps until half roof is complete.

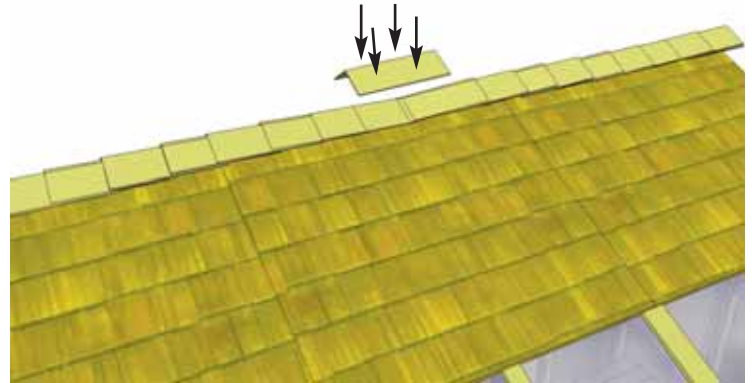
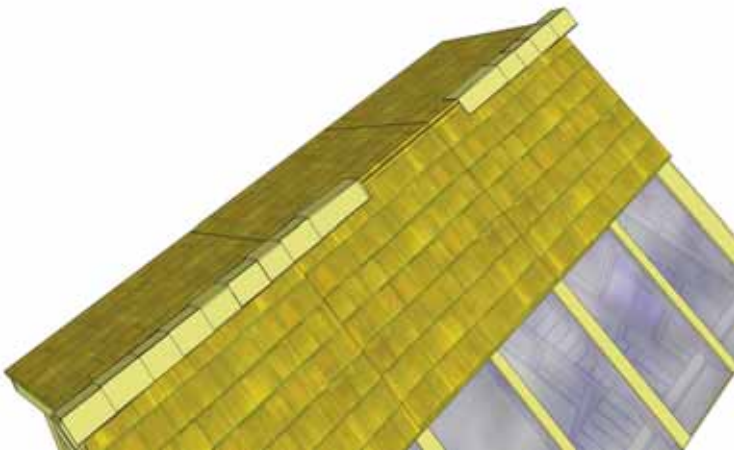

95. From opposite side, position and attach Ridge Caps as described above starting with the Undercourse Ridge Cap. The center Ridge Cap is cut to 12" to fit in the center of roof. Attach center cap with 4 - 1 1/2" Shingle Nails.

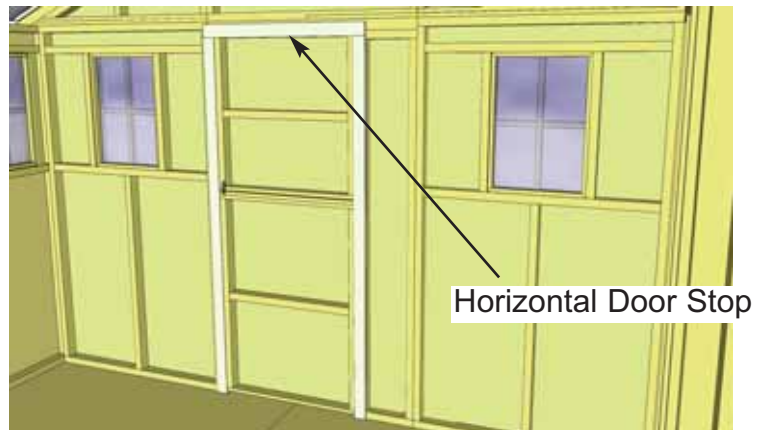
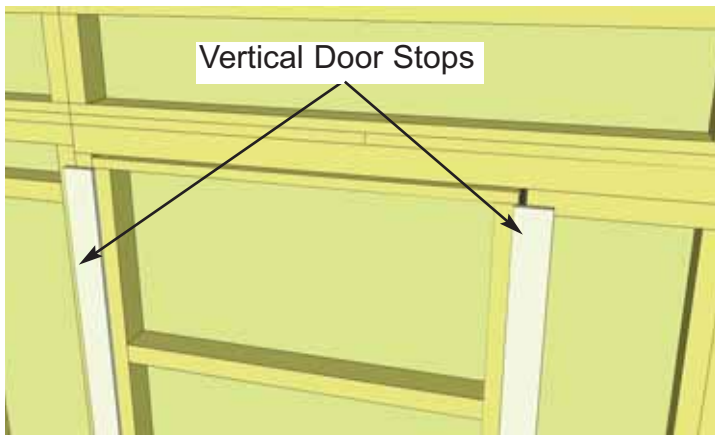

96. Attach Interior **Vertical and Horizontal Door Stops** to door framing from inside of shed. Use 4 - 2" screws to secure each Stop. Stops should overlap door by approx. 1/2"

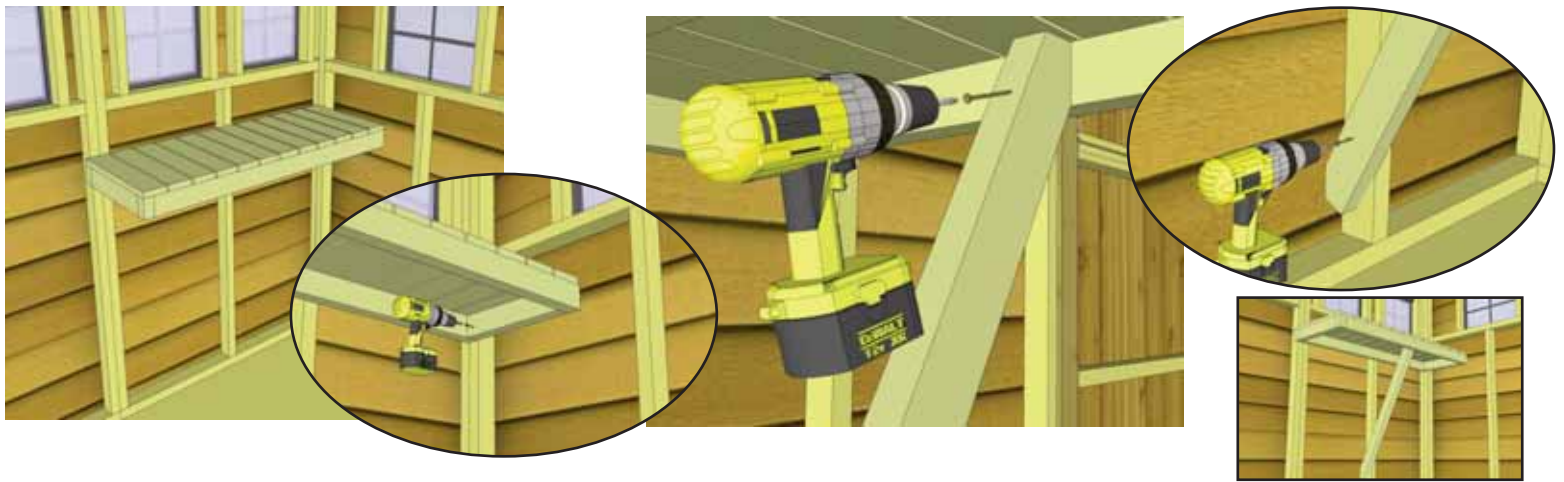

97. Locate 1 Long **Potting Shelf** and 1 **Leg**. Position shelf in corner tight against wall framing. While supporting the shelf, attach shelf with 2 1/2" screw. Place leg underneath shelf and attach to inside shelf frame and wall framing as illustrated above with 2 1/2" screws.



98. Place Short Potting Shelf against wall framing and end of long shelf framing. Attach with 2 1/2 " screws as per **Step 97**. Use a level to confirm shelving is square and level. Attach leg as previously illustrated. Screw to wall stud and up into the underside of the of shelf framing.

Complete attaching remaining long shelves as per **Steps 97 & 98**.



Completed
Potting Shelf

Outdoor Living Today Flower Box Assembly Instructions

Parts Lists:

A - Base, Rear & Front Box Frames	(3pcs)	3/4" x 5 1/2" x 23"
B - End Cap Frames	(2pcs)	3/4" x 5 1/2" x 7" / 8"
C - Front Trim	(1 pc)	3/4" x 1 1/2" x 26"
D - Side Trims	(2 pc)	3/4" x 1 1/2" x 8 3/4"
E - Brackets	(2 pc)	1 1/2" x 5 1/2" x 5 1/2"
F - 1 1/4" Screws		
G - 1 1/4" Nails		

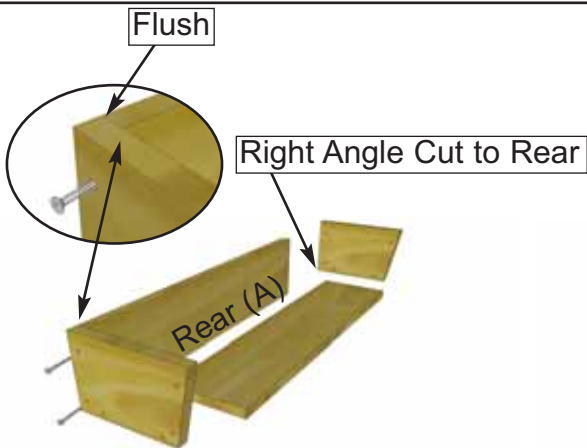
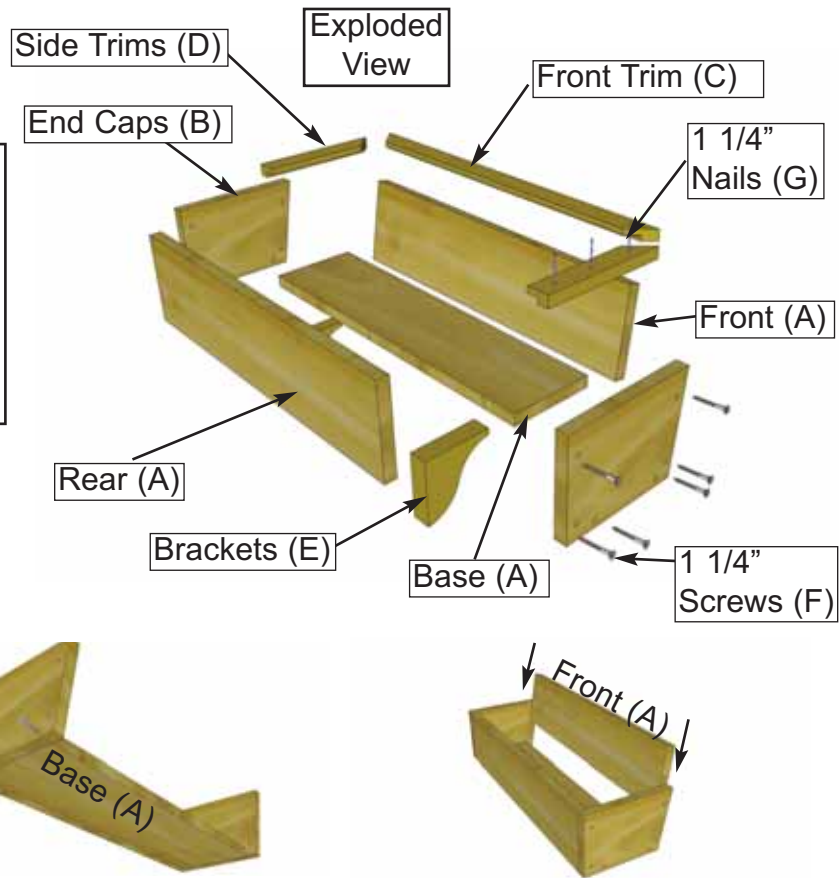

1. On a table position Rear Box and End Cap Frames together so flush at top. Fasten together with 2 - 1 1/4" screws. Place Base Frame tight against Rear and End Cap and flush at bottom. Secure with 2 - 1 1/4" screws. Complete attachment of remaining End Cap Frame. Slide Front Frame between End Caps.

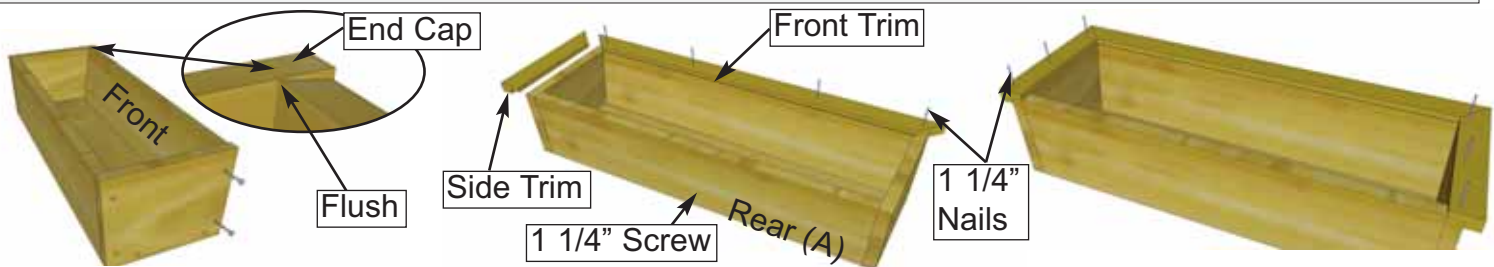

2. Position Front Frame Piece flush with End Cap. Attach both ends with 2 - 1 1/4" screws. Pilot hole Rear Box Frame near bottom center and secure to Base edge with 1 - 1 1/4" screw. Evenly position Front Trim (mitre cut on end and dado cut on inside bottom) tight against front frame and nail down with 4 - 1 1/4" nails. Position Side Trims as per Front and secure with 3 - 1 1/4" nails per side.

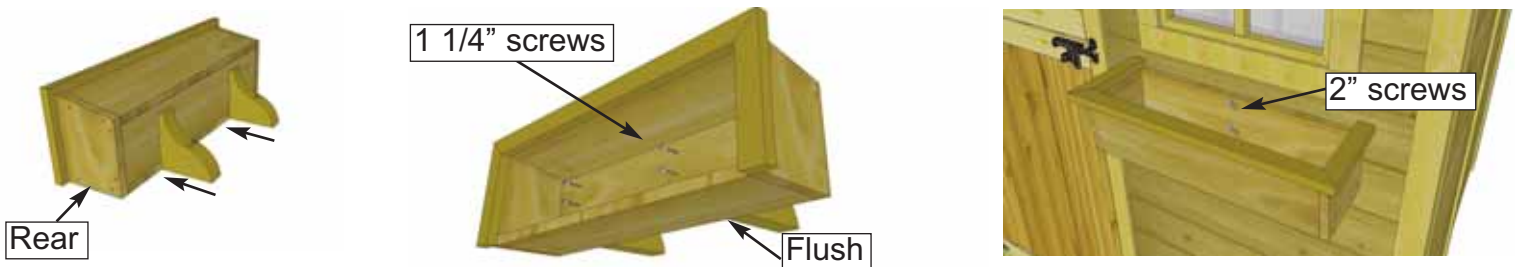

3. On a flat surface, flip Flower Box on it's rear face. Evenly space Brackets and secure through Base Frame and into the Brackets with 2 - 1 1/4" screws per Bracket. Position completed Flower Box beneath window trim and screw from inside of box into the center wall stud with 2 - 2" screws. (2" screws supplied with Base Kit.)



Note; Our Sheds are shipped as an unfinished product. If exposed to the elements, the western red cedar lumber will weather to a silvery-gray color. If you prefer to keep the cedar lumber looking closer to the original color, we suggest that you treat the wood with a good oil base wood stain. You may also wish to paint your new shed rather than stain it. In both cases we recommend that you consult with a paint and stain dealer in your area for their recommendations.

We hope your experience constructing our building has been both positive and rewarding.

We value your feedback and would like to hear back from you on how well we are doing in the following areas:

1. **Customer Service**
2. **On Time Shipping**
3. **Motor Freight Delivery**
4. **Quality of Materials**
5. **Assembly Manual**
6. **Overall Satisfaction.**



The materials contained in this Assembly Manual may be downloaded or copied provided that ALL copies retain the copyright and any other proprietary notices contained on the materials. No material may be modified, edited or taken out of context such that its use creates a false or misleading statement or impression as to the positions, statements or actions.

Please call, write or email us at:

Outdoor Living Today

Canadian Address
9393 287th Street
Maple Ridge, British Columbia
Canada V2W 1L1

United States Address
P.O. Box 96
Sumas, Washington
USA 98295