



12x8 Studio Garden Shed FJ Bevel Model with Metal Roof Assembly Manual

Version #2.3

Apr 28, 2022

Stock Code #

STU128-FJ-Metal

Thank you for purchasing a 12x8 Studio Garden Shed. Please take the time to identify all the parts prior to assembly.

Safety Points and Other Considerations
Our products are built for use based on proper installation on level ground and normal residential use. Please follow the instruction manual when building your shed and retain the manual for future maintenance purposes.

Customers are responsible for ensuring a solid, level, well-draining site for construction.

Please check with your local municipal or county by-laws before ordering this product to confirm it complies with building codes.



- Snow load ratings vary by geographical location. If heavy or wet snowfall occurs, it is advisable to sweep snow off roof frequently.
- If the product is elevated, any structural and building code requirements are solely the customer's responsibility, and should be abided by.
- In areas with high or gusty wind conditions, it is advisable to install the structure securely to the ground.
- Have a regular maintenance plan to ensure screws, doors, windows and parts are tightly affixed.

Customer agrees to hold Outdoor Living Today and any Authorized Dealers free of any liability for improper installation, maintenance and repair.



In the event of a missing or broken piece, call the Outdoor Living Today Customer Support Line @ 1-888-658-1658 within 30 days of the delivery of your purchase. It is our commitment to you to courier replacement parts, free of charge, within 10 business days of this notification. Replacement parts will not be provided free of charge after the 30 day grace period.

All structures purchased from Outdoor Living Today are covered for a period of one year for defects in manufacturing and workmanship. Costs incurred for customer installations are not included.

Failure to use supplied parts included in this kit could result in poor product performance and may void your warranty. Please contact Outdoor Living Today's Customer Toll Free Line if you plan to deviate from our written instructions.

What to do before my Shed arrives?



- Become familiar with this assembly manual and determine if you can complete the project yourself or will require a professional contractor.



- One helper is recommended to assist in constructing your shed. It generally takes two people over two days to assemble a shed. If you're hiring a contractor, their rate should be in line with that duration of work.



- Clear the construction area and ensure a clear pathway for delivery when the freight company arrives. Remove all debris: roots, grass, rocks, etc.



- Excavate the site. Contact your local utilities company to ensure there are no gas or electric lines buried in the area before digging.

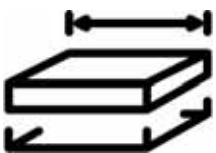

- Decide on the type of foundation you will be using:
 - Concrete slab, or
 - 4-6 inches of crushed gravel with paver stones or 4x4 stringers.

You can find the footprint for your shed on Page 3 of your Assembly Manual.



- If doing the assembly yourself, have all the necessary tools ready to go and in working condition. A list of required tools can be found after the parts list.



Foundation Types for 8x12 Garden Shed

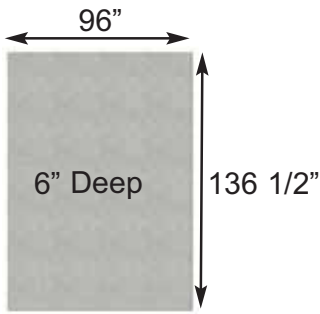

Concrete Foundation

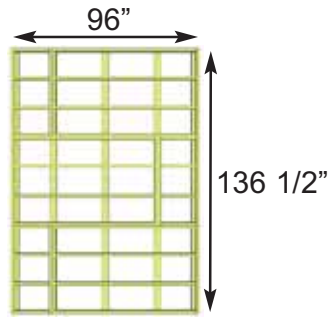

Floor Frame



Completed Foundation

Concrete Slab Foundation:

- Slab must be at least the same size as assembled floor frame (136 1/2" x 96") or larger.
- 6" Deep foundation.
- 1.7 Cubic Yards of concrete required.
- A concrete slab will have the longest durability out of your foundation options.

Once level, a concrete slab is the easiest surface to build on.

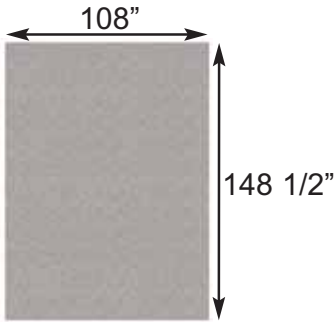

Gravel Foundation

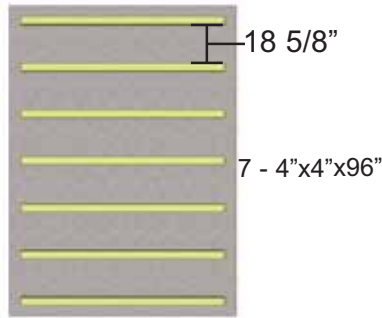

Gravel Foundation with treated stringers

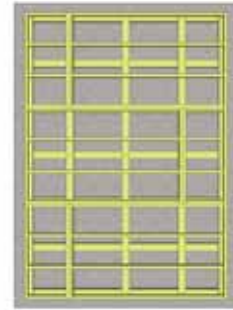

Completed Foundation

Gravel with 4x4 Pressure Treated Stringers:

- Excavate at least 6" deep, and 6" wider than floor frame on each side.
- 2.1 Cubic Yards of gravel required, approximately 19 wheelbarrows.
- 7 - 4x4 Pressure Treated Stringers 8' long required.
- Evenly spaced, with one at each end of floor frame.

Saves money on materials, easy to level and work with.

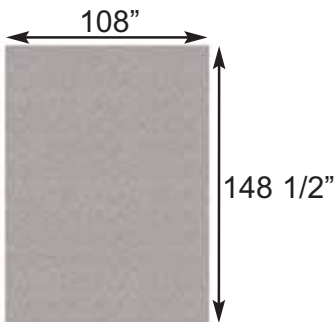

Gravel Foundation



Gravel Foundation with Patio Pavers

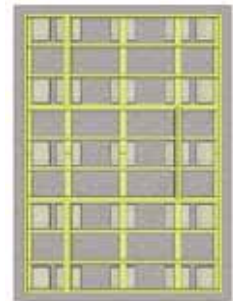

Completed Foundation

Gravel with Patio Paver Stones:

- Excavate at least 6" deep, and 6" wider than floor frame on each side.
- 2.1 Cubic Yards of gravel required, approximately 19 wheelbarrows.
- 25 patio pavers (8" x 8" or larger).
- Center patio paver stones underneath floor runners and underneath seams in floor joists.

Patio paver stones are widely available from most landscape stores.

**Thank you for purchasing our 12x8 Studio Garden Shed.
Please take the time to identify all the parts prior to assembly.**

1. Floor Section	Parts List - Pages 2 and 3	Steps ↓
Floors -----		
1A: 3 - 45 1/2" x 75" - Floor Joist Frames		1-12
1B: 6 - 1 1/2" x 3 1/2" x 71 3/4" - Center Floor Joists - Unattached		
1C: 3 - 45 1/2" x 21" - Floor Joist Frames		
1D: 3 - 45 1/2" x 75" - Plywood Floor - Large		
1E: 3 - 45 1/2" x 21" - Plywood Floor - Small		
1F: 10 - 1 1/2" x 3 1/2" x 68 3/16" Floor Runners		
2. Wall Section		Steps ↓
Main Wall Panels -----		
2A: 2 - 48 3/4"w x 80 1/4"h - Front Window Wall Panels		13-20
2B: 7 - 45 1/2"w x 75"h - Solid Wall Panels (Bottom Plates Unattached)		
2C: 7 - 1 5/8" x 2 1/2" x 45 3/8" - Bottom Wall Plates		
Main Wall Plates -----		
2D: 5 - 3/4" x 2 1/2" x 65 3/4" - Rear/Side/Middle Front		21-22, 30
2E: 2 - 3/4" x 2 1/2" x 35 3/8" - Front		
2F: 2 - 3/4" x 2 1/2" x 27 3/4" - Side		
Rear Extender Walls - Rectangular -----		
2G: 3 - 45 1/2"w x 9"h - Rear Extender Walls		23-24
Side Gable Walls (Trapezoid Shape) -----		
2H: 2 - 45 1/2" w x 19" h x 10" h - Rear Side Gable Walls (R/L)		25-27
2I: 2 - 45 1/2" w x 28" h x 19" h - Front Side Gable Walls (R/L)		
Upper Wall Plates -----		
2J: 2 - 3/4" x 2 1/2" x 68 1/4" - 11 degree angle - Front		28, 30, 34
2K: 2 - 3/4" x 2 1/2" x 68 1/4" - 11 degree angle - Rear		
Door Jambs -----		
2L: 2 - 3/4" x 3 3/8" x 80 1/4" - Vertical Door Jambs		29
Upper Front Walls -----		
2M: 2 - 48 1/2"w x 22 3/4"h - Upper Front Window Walls		31-33
2N: 1 - 39 1/2"w x 22 3/4"h - Centre Upper Front Window Wall		
3. Rafter & Roof Section		Steps ↓
Rafters -----		
3A: 14 - 1 1/2" x 3 1/2" x 47" - Rafters (11° angle cut on ends)		37-47
3B: 14 - 1 1/2" x 3 1/2" x 72" - Rafters (11° angle cut on ends)		
3C: 4 - 1 1/2" x 3 1/2" x 59 1/2" - Rafter Facia (11° angle cut on ends)		
Rafter Spacers -----		
3D: 2 - 1/2" x 2 1/2" x 60" Plywood Spacer Jig - Sides		40-49
3E: 1 - 1/2" x 2 1/2" x 44 7/8" Plywood Spacer Jig - Center		
3F: 2 pcs - Front Rafter Overhang Spacer - 14 1/2" long (shingle marked)		
Roof Battens (20) -----		
3G: 8 pcs - 3/4" x 3 1/2" x 72" Roof Batten (Long)		50-60
3H: 12 pcs - 3/4" x 3 1/2" x 48" Roof Batten (Short)		
Roof Panels (8) -----		
3I: 4 - 39" wide x 86" long - Metal Roof Panels (Long)		61-69
3J: 4 - 39" wide x 41" long - Metal Roof Panels (Short)		
Facia/Roof Nailing Strips -----		
3L: 2 - 3/4" x 1 1/2" x 72"		70
3M: 2 - 3/4" x 1 1/2" x 44"		
4. Trim Section		Steps ↓
Soffits Front -----		
4A: 2 - 3/4" x 3" x 14" (Outside L/R Cap)		71-74
4B: 8 - 3/4" x 3 1/2" x 67" (Tongue & Groove)		
4C: 2 - 3/4" x 2 1/4" x 67" (Tongue cut off - positioned against shed)		
4D: 1 - 1/2" x 2 1/2" x 13 3/4" (Center Cap)		

4. Trim Section Cont.	Steps ↓
Soffits Rear 4E: 2 - 3/4" x 3" x 6 1/2" (Outside L/R Cap) 4F: 2 - 3/4" x 3 1/2" x 67" (Tongue & Groove) 4G: 2 - 3/4" x 3" x 67" (Tongue cut off - positioned against shed) 4H: 1 - 1/2" x 2 1/2" x 5 1/4" (Center Cap)	75- 76
Top Horizontal Wall Trim 4I: 1 - 1/2" x 1" x 39" - Front 4J: 2 - 1/2" x 1" x 48 3/4" - Front 4K: 3 - 1/2" x 1" x 45 1/2" - Rear	77
Facia Trim 4L: 4 - 3/4" x 5 1/2" x 72 3/4" - Front/Rear 4M: 4 - 3/4" x 5 1/2" x 60" - Side (11° cut ends- mirror Image) 4N: 3 - 1/2" x 7 1/2" w x 5 1/2" - Facia Detail Plates	78-82, 85
Metal Roof Drip Cap (3) 3K: 3 pcs - 6" x 60" (angled)	83-84
Bottom Skirting Trim Side and Rear 4O: 7 - 1/2" x 4 1/2" x 45 1/2" - Bottom Skirting Front 4P: 1 - 1/2" x 4 1/2" x 39" - Center Bottom Skirting 4Q: 2 - 1/2" x 4 1/2" x 48 3/4" - Outside Bottom Skirting	86-88
Corner & Wall Trim Filler 4R: 4 - 3/4" x 2 1/2" x 72" - Filler Trims (all corners) 4S: 2 - 3/4" x 2 1/2" x 28 1/2" - Filler Trims (Front top) 4T: 2 - 3/4" x 2 1/2" x 12" - Filler Trims (Rear top)	89
Corner 4U: 2 - 1/2" x 2 1/2" x 46" - Top Front Narrow Corner (22° scarf cut) 4V: 2 - 1/2" x 5 1/2" x 46 1/2" -Top Front Side Wide Corner (22° scarf /11°cut top) 4W: 2 - 1/2" x 2 1/2" x 62" - Bottom Front Narrow Corner (22° scarf cut) 4X: 2 - 1/2" x 5 1/2" x 62" - Bottom Front Side Wide Corner (22° scarf cut) 4Y: 2 - 1/2" x 5 1/2" x 91" - Rear Side Wide Corner (11° cut top - mirror) 4Z: 2 - 1/2" x 2 1/2" x 89" - Rear Corner Narrow	90-92
Side 4AB: 2 - 1/2" x 2 1/2" x 37 3/4" - Top Side (22° scarf /11° cut top - mirror image) 4AC: 2 - 1/2" x 2 1/2" x 62" - Bottom Side (22° scarf cut)	93
Rear 4AD: 2 - 1/2" x 2 1/2" x 89" - Rear Walls	94
Pre-Hung Door (Fiberglass - primed white) 4AE: 1 - 37 1/2" x 80"	95-96
Door Trim 4AF: 1 - 1/2" x 1 3/4" x 40" - Above Door Filler Trim (Bevel-install thick end up) 4AG: 2 - 1/2" x 2 1/2" x 84" - Vertical Door Trim 4AH: 1 - 1/2" x 3" x 44 1/2" - Horizontal Door Trim (angle cut - bottom corners)	97-98
Windows 4AI: 2 - Large Window Inserts - 30 1/4"w x 35" h 4AJ: 3 - Transom Window Inserts - 35"w x 10 1/8" h	99-102
Window Trim Pkgs. 4AK: Large Windows (2 Pkgs) Top-1 -36 1/4" 11° cut / Sides - 2 -36 1/8" sq.cut / Bottom- 1 -35 1/4" sq.cut	103
4AL: Transom Windows (Left/Right) 2 Pkgs Top-1 - 41" 11° cut / Sides- 2 -10 5/8" sq.cut / Bottom-1 -40" sq.cut	104
4AM: Transom Window (Center) 1 Pkg 2 Horizontal - 35 3/4" - sq.cut / 2 Vertical - 20 1/2" - sq.cut	105
Miscellaneous Pieces 4AN: 2 pc - Spare Wall Siding (48 1/2" long) 4AO: 8 pcs - Shim Shingles- use to shim door, etc. 4AP: Several pcs - Foam Enclosures for Metal Roof	

If you plan on painting your door, we suggest doing it prior to construction

12X8 Studio Garden Shed - Metal Roof - HARDWARE PACKAGE

Hardware Kit (Provided)

S1 - 2 1/2" Screws  x 496

S3 - 2" Screws  x 71

S2 - 1 1/4" Screws  x 356

N1 - 1 1/2" Finishing Nails  x 475

BR1 - Square Drive Bit  x 2

1/4"x 2" Metal Roof Screw  x 50

 x 1
1/4" Nut Driver

Y38 - Metal Roof Hanger x 4

Y2 - 90° Metal Bracket (Roof) x 20

Silicon Caulking (2)

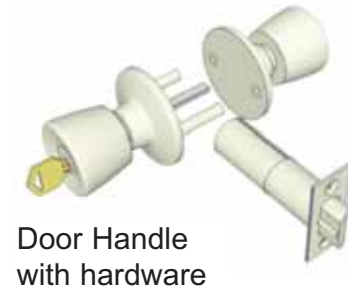

Tools Required (Not Provided)



Hammer



Screw Gun/Drill



Tape Measure



3/8" Nut Driver



Wood Clamp



Phillips Screwdriver



Level



Pliers



2 Ladders



1/8" & 3/8" Drill Bits

Safety Equipment Required (Not Provided)



Safety Glasses



Work Gloves

Regular Maintenance & Tips to prolong the life of your shed.

Before/During Assembly:

- 1.) Paint each face and edge of your plywood floor with a latex exterior paint.
- 2.) Caulk wall seams if gaps appear.
- 3.) Caulk around window framing.
- 4.) Caulk perimeter between floor plywood and bottom wall plate.
- 5.) Caulk channels in lap siding at the top of your door above the trim, just a drop in each channel.
- 6.) Caulk edge of door threshold.
- 7.) Optional: Install a Sill Gasket between floor runners and foundation.
- 8.) Optional: Install an 8" strip of roofing paper below Cedar Ridge Caps for Cedar Roof Sheds.

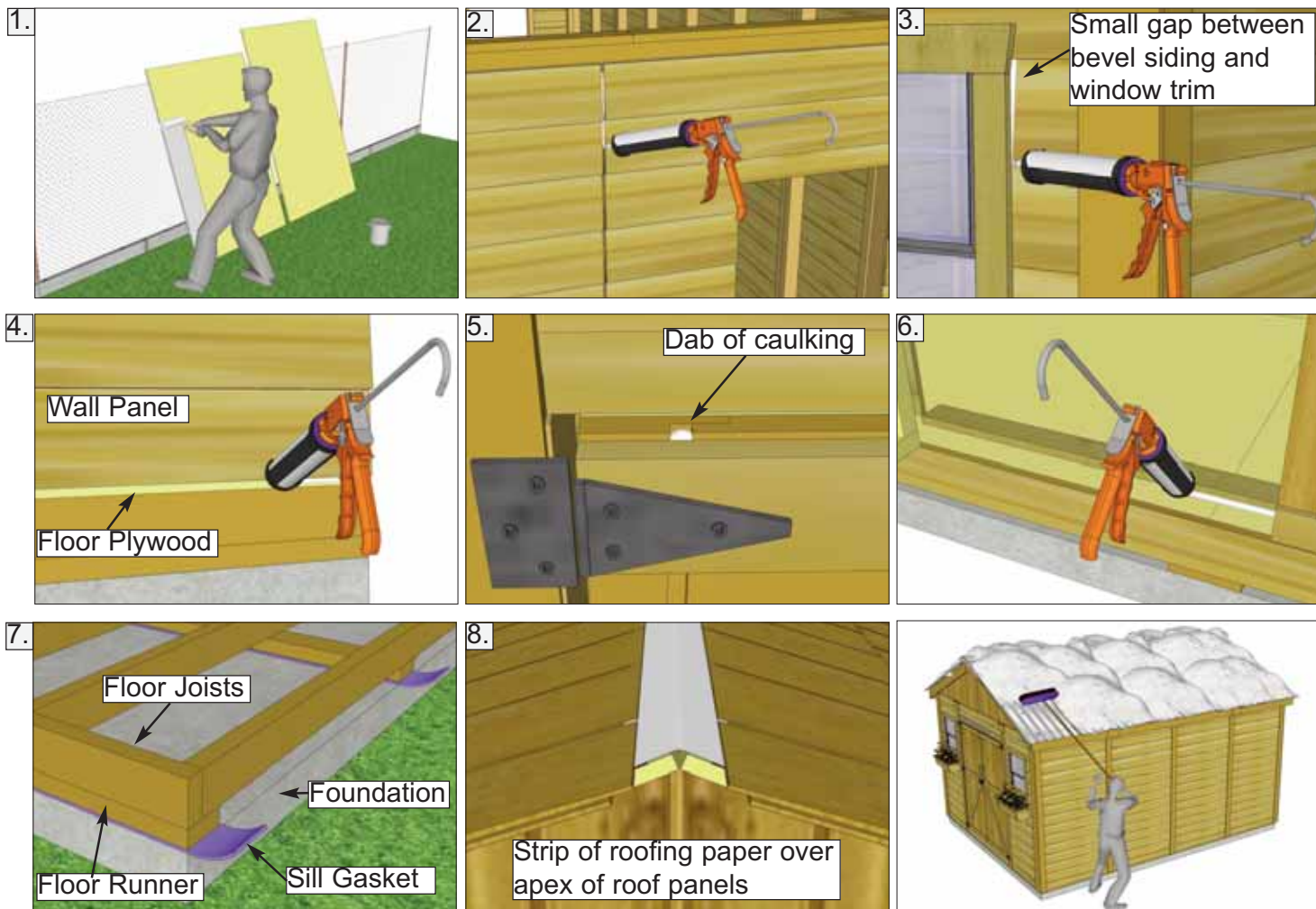

Routine Maintenance:

- Routinely check all fasteners are tight (ex. Door Hinges, Nails)
- Brush off dirt from walls.
- Brush off snow from roof regularly.
- Routinely remove needles and leaves from roof.

Painting/Staining

- Your cedar shed, if left untreated, will weather to a silvery grey colour.
- Painting or staining your structure is highly recommended and will prolong the life of your shed.
- You do not need to wait to paint or stain your shed, the wood in your kit has been dried and can be stained or painted immediately.
- Consult your local paint store for the best paint or stain for cedar.
- Optional: stain the inside of your shed. (Note: this will remove the fresh cedar smell.)

1. Floor Section

Exploded view of all parts necessary to complete Floor Section. Identify all parts prior to starting. Note: Floor Footprint is 136 1/2" wide x 96" deep.

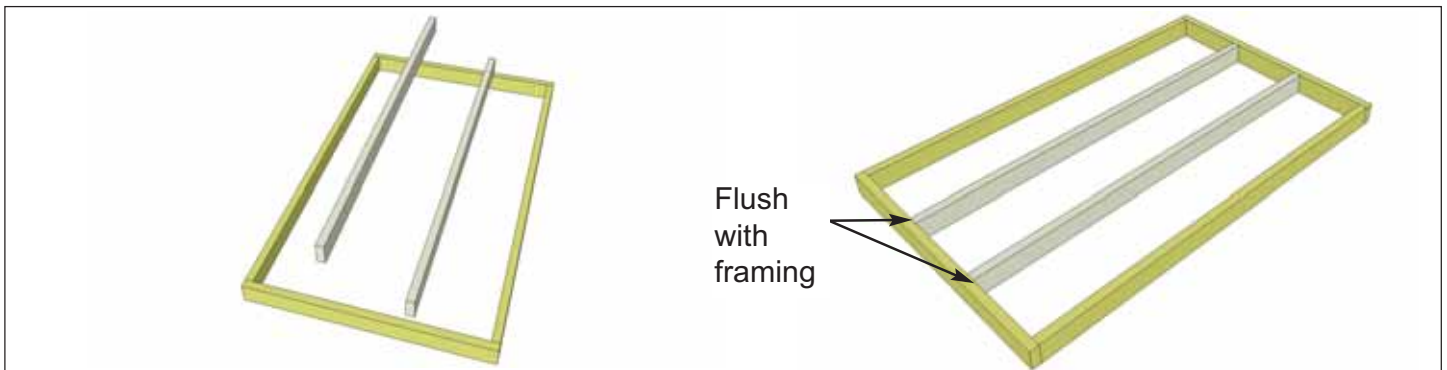
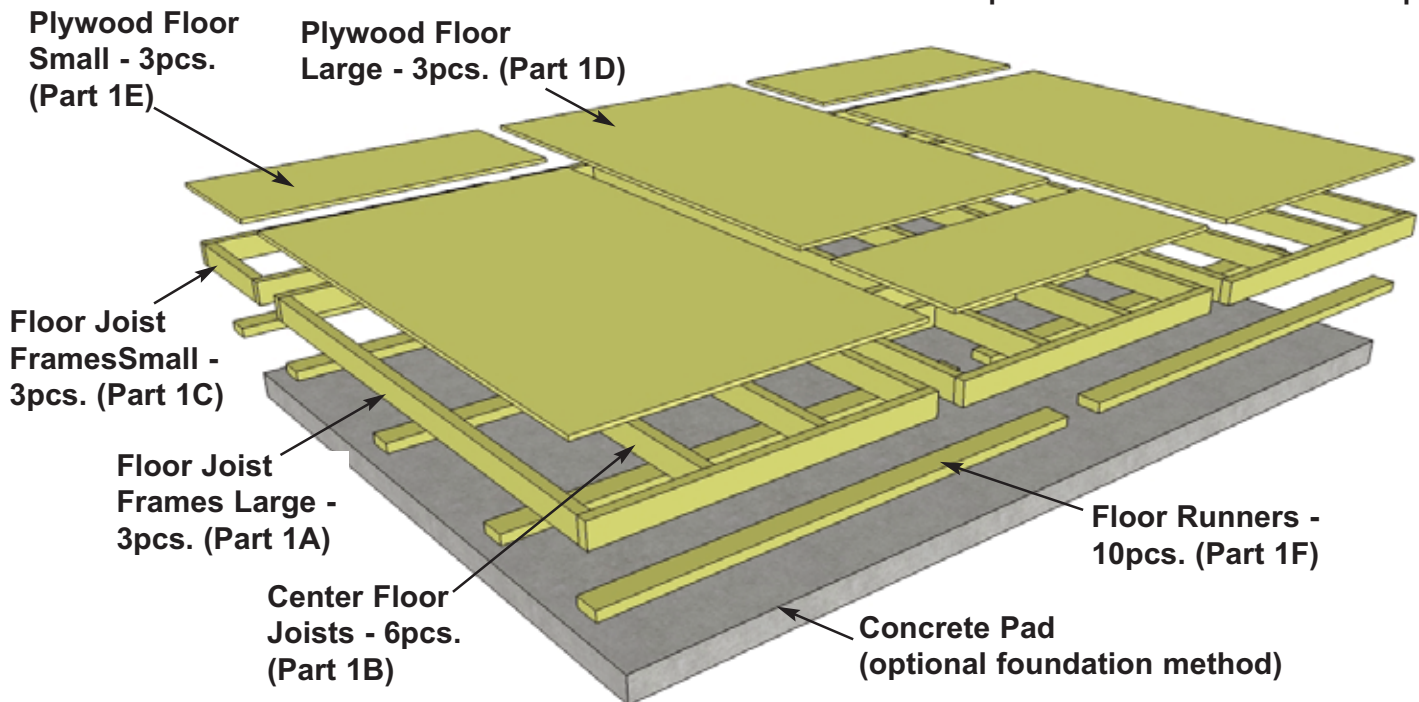

1. Lay out **1A - Floor Joist Frames** and two of **1B - Floor Joists** as illustrated above. Position Joists equally in Floor Joist Frame. Use **1C - Small Floor Joist Frame** as a template to determine joist position. Position Joist so flush with framing.

Parts (Steps 1 - 2)
1A - Large Floor Joist Frames
 (45 1/2" x 75") x 3
1B - Floor Joists
 (1 1/2" x 3 1/2" x 71 3/4") x 6

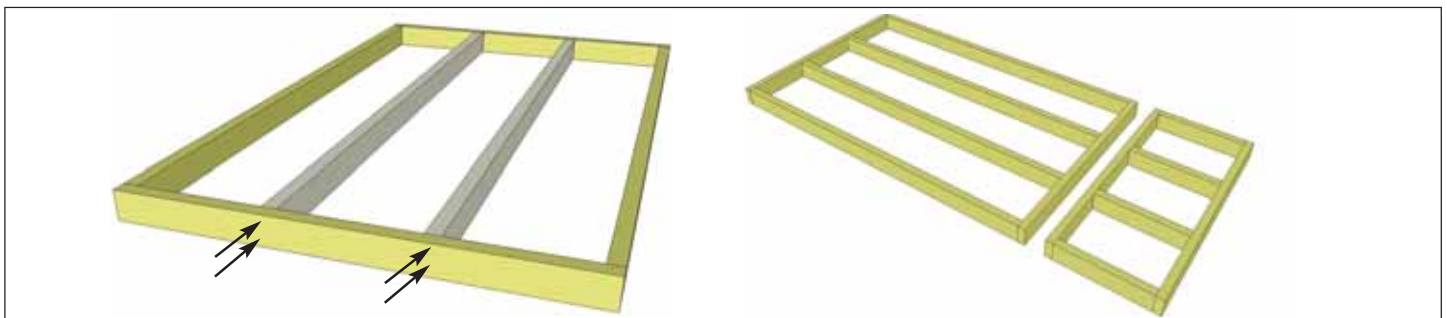

2. When correctly positioned, attach each Joist with **4 - 2 1/2" screws** (2 per end). **You can find the Square Drive Screw Bit in the Hardware Kit Bag.** Complete 2 remaining Large Floor Joist Frames.

Hardware
S1 - 2 1/2" Screws
 x 24 total

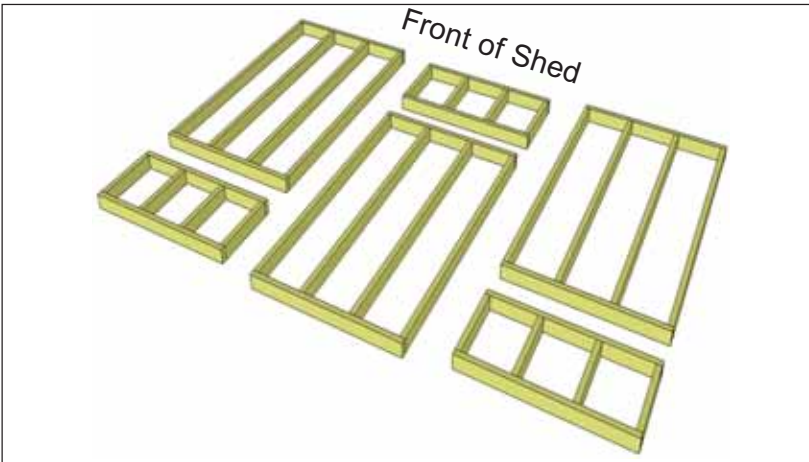

3. Lay out **1A & 1C - Floor Joist Frames** as illustrated. There are 3 larger and 3 smaller Frame Sections. The Footprint for the floor when attached together will be 136 1/2" wide x 96" deep.

You can find BR1 - Square Drive Bit for the screws in with the Hardware Kit Bag.

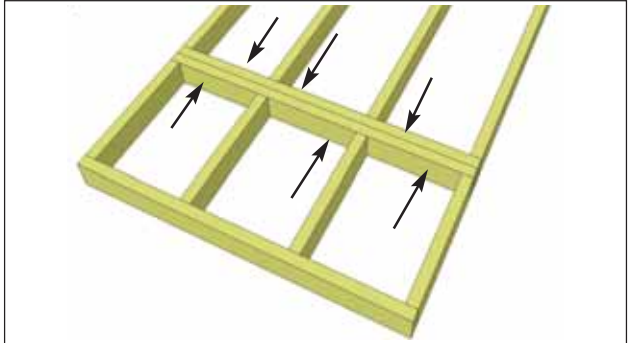

4. Attach each large and small floor joist frame together with **6 - 2 1/2" screws** per section.

Hardware
(S1 - 2 1/2" Screws) x 18 total



5. Complete all large and small frame attachments. Screw each completed section together with **8 - 2 1/2" screws**.

Hardware
S1 - 2 1/2" Screws
x 16 total

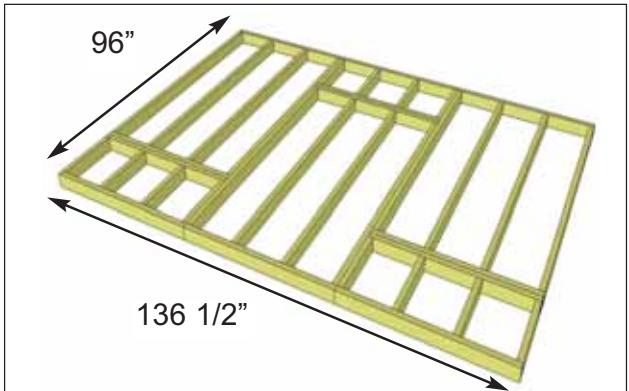

6. When completed, your floor footprint should be 136 1/2" wide x 96" deep.

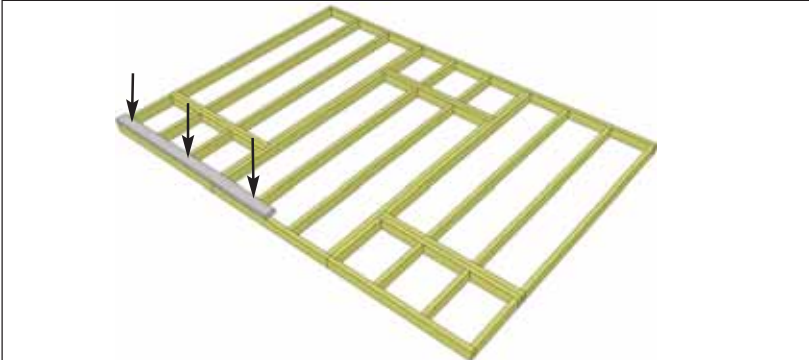

7. Attach **1F - Floor Runners** to completed floor frame. There are 2 floor runners per 136 1/2" side and 5 completed runners in total. Use **3 - 2 1/2" screws** per runner section.

Parts (Steps 7 - 9)
1F - Floor Runners
(1 1/2" x 3 1/2" x 68 3/16")
x 10
Hardware (Steps 7 - 9)
S1 - 2 1/2" Screws
x 30 total

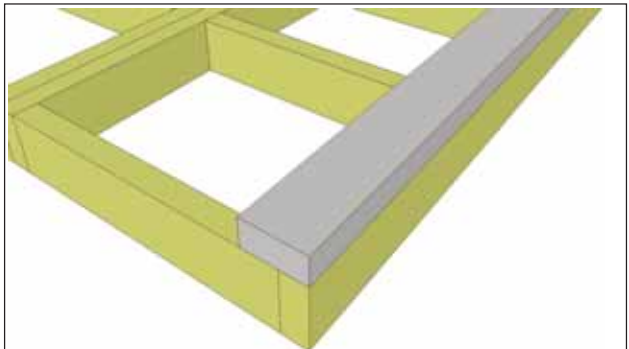

8. Make sure Runners are flush with outside and front and rear floor framing but not overhanging.



9. Complete remaining Floor Runners.

Foundations

Note: The floor will be flipped over and the floor runners will sit on your foundation. It is important to note, that having a level foundation is critical. Choosing a foundation will vary between regions. Typical foundations can be concrete pads or patio stones positioned underneath the floor runners.

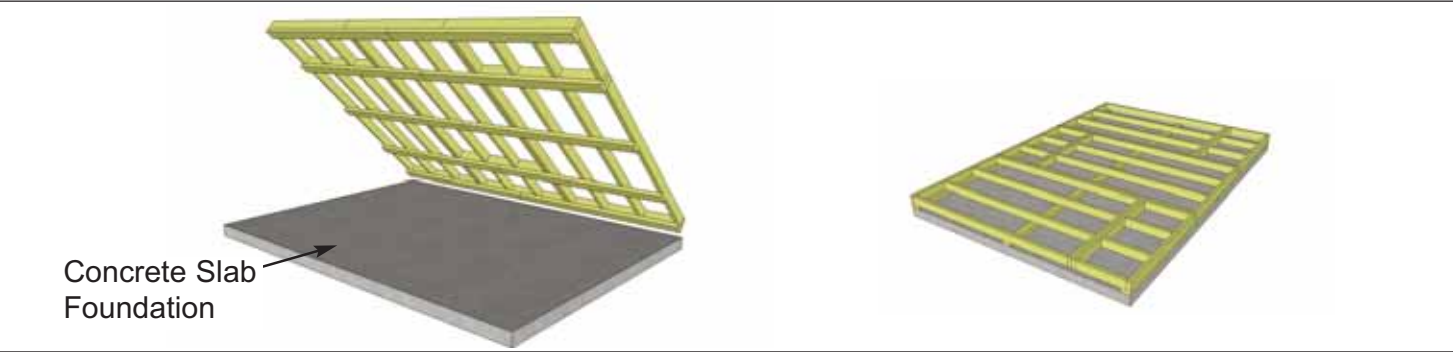

10. With Floor Runners attached, carefully flip the floor over and place on your foundation.
Caution: you will need 2 people to assist you. Be careful when laying floor down not to bend or twist floor. When in place, level floor completely.

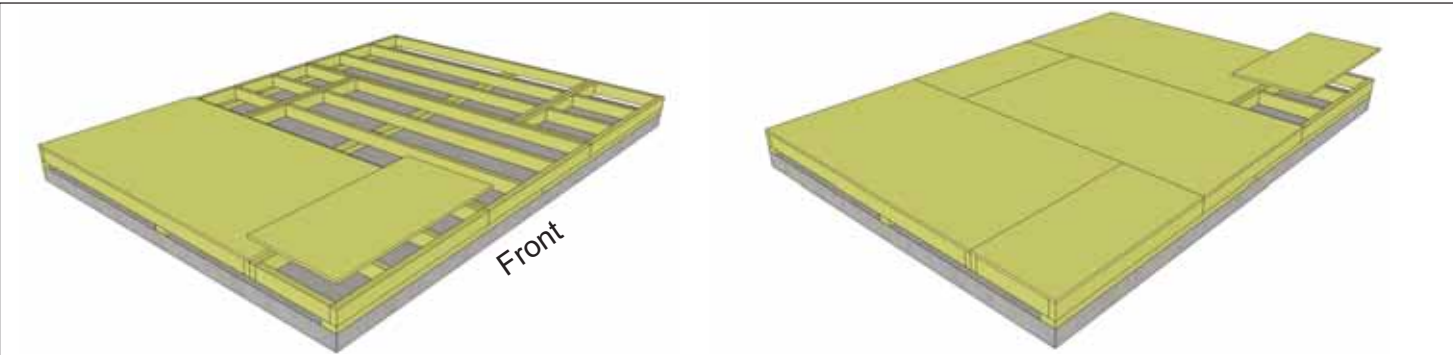

11. Position parts **1D & 1E - Plywood Floor** on top of completed floor joists. Plywood will sit flush with outside of floor joist frame.

- Parts
- 1D - Plywood Floor - Large**
(5/8" x 45 3/8" x 74 7/8") x 3
 - 1E - Plywood Floor - Small**
(5/8" x 45 3/8" x 20 7/8") x 3

12. With Plywood positioned correctly on floor framing, attach with **1 1/4" Screws**. Use screws every 16" around perimeter of each large floor section and 3 screws through each mid joists. Adjust for smaller floor sections accordingly.

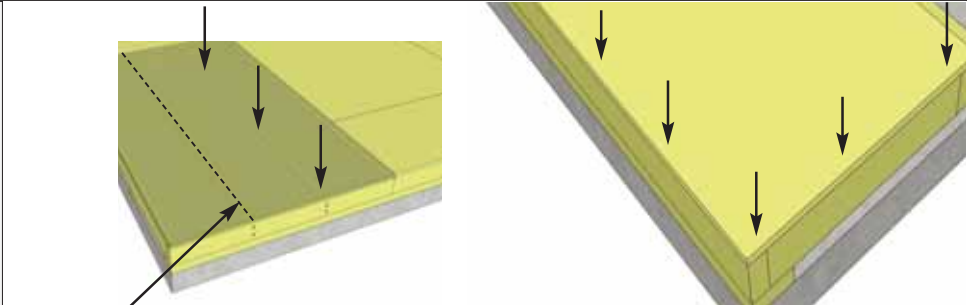

- Hardware
- S2 - 1 1/4" Screws**
x 100 total (approx.)

Use chalk line to mark location of mid joists for interior screws.

2. Wall Section

Exploded view of all parts necessary to complete the Wall Section. Identify all parts prior to starting.

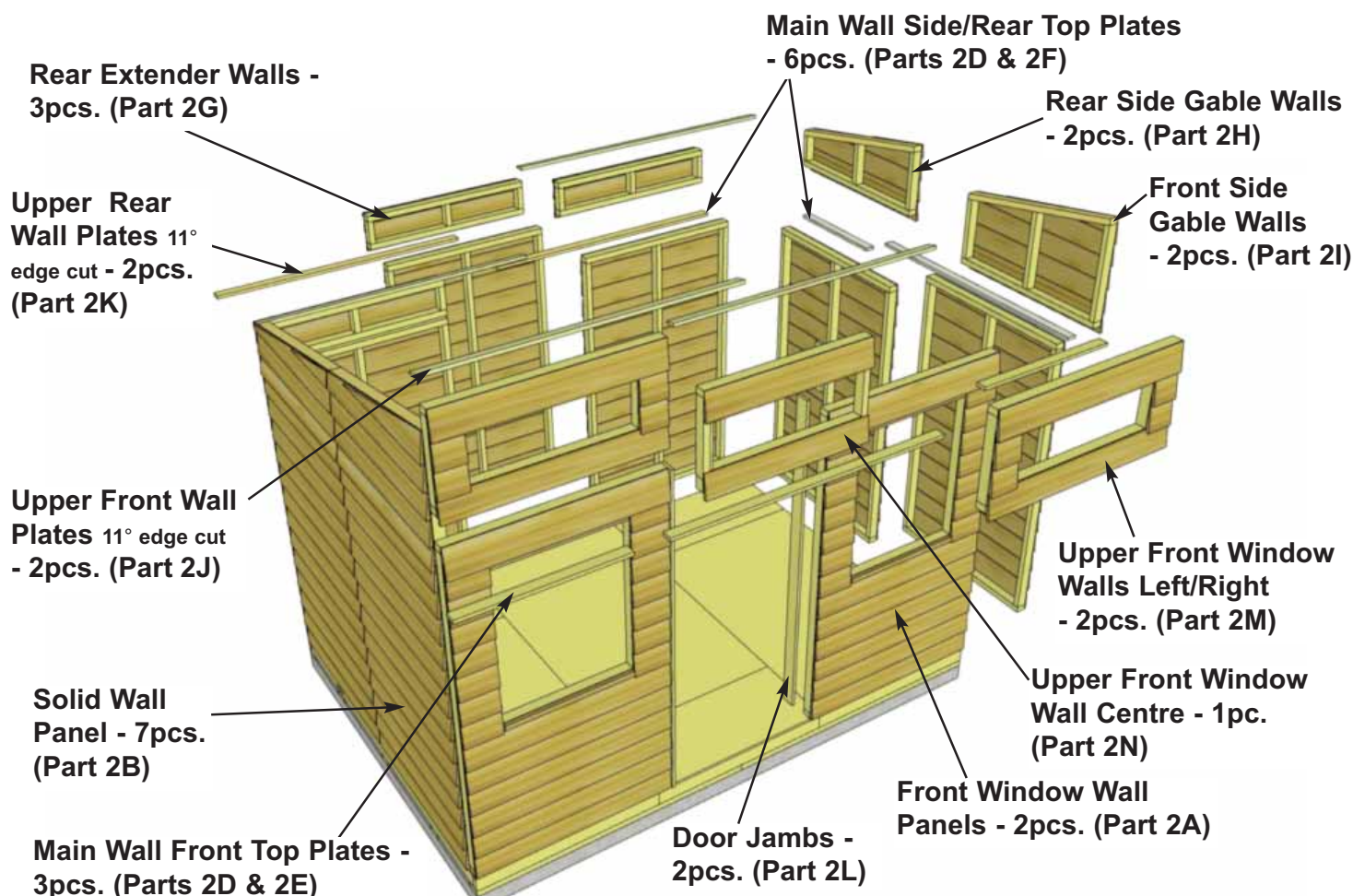

13. Identify all wall section components and become familiar with their location.

There will be **2 Window Wall Panels**, **7 Solid Wall Panels**, **4 trapezoid shaped Side Gable Walls**, **3 Rear Extender Walls** and **Top Plates (upper and lower)**.

Make sure to position panels right side up so water is directed away from and not into shed. Look at window wall panels to determine proper wall position to confirm.

(Walls may have a QC colored dot on them, these won't be visible on the shed, please ignore them).

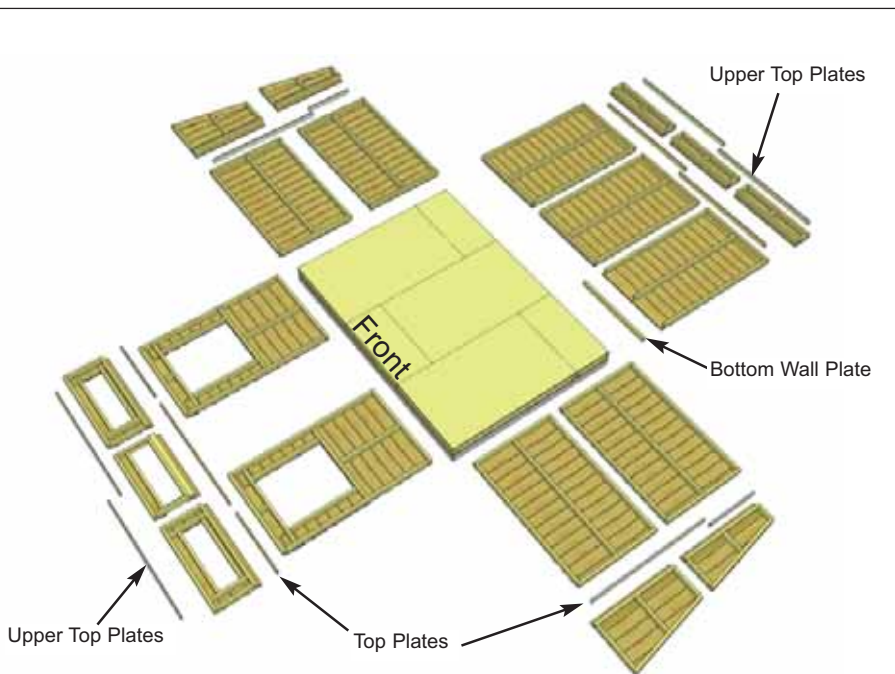

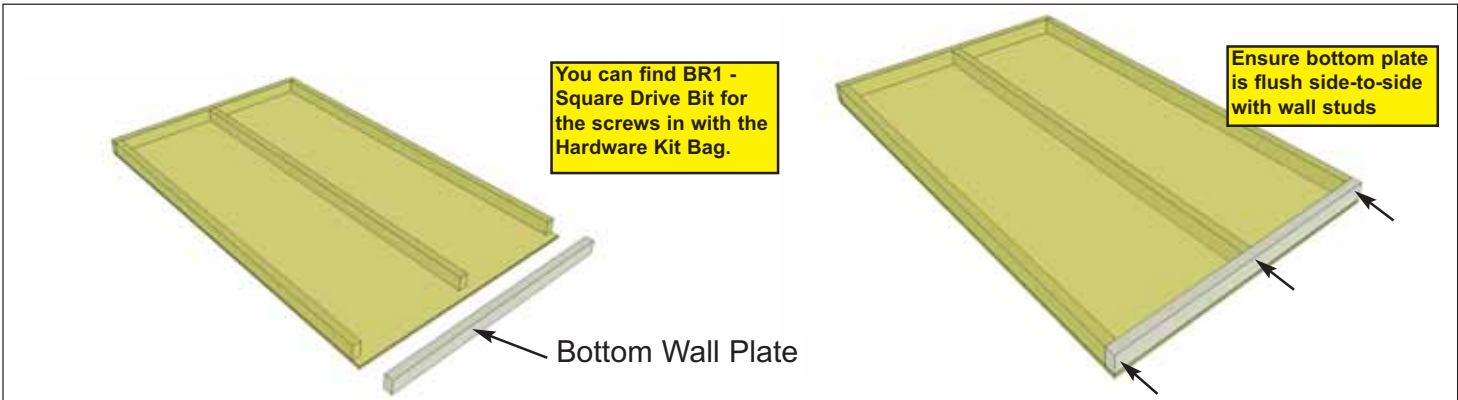

14. Carefully lay **2B - Solid Wall Panels** face down. Position and attach **2C - Bottom Wall Plates** to bottom of wall studs of each wall panel with **3 - 2 1/2" Screws**. Position so plates are flush with framing.

Parts
2B - Solid Wall Panels (45 1/2" wide x 75" high) x 7
2C - Bottom Wall Plates (1 5/8" x 2 1/2" x 45 3/8") x 7

Hardware
S1 - 2 1/2" Screws x 21 total

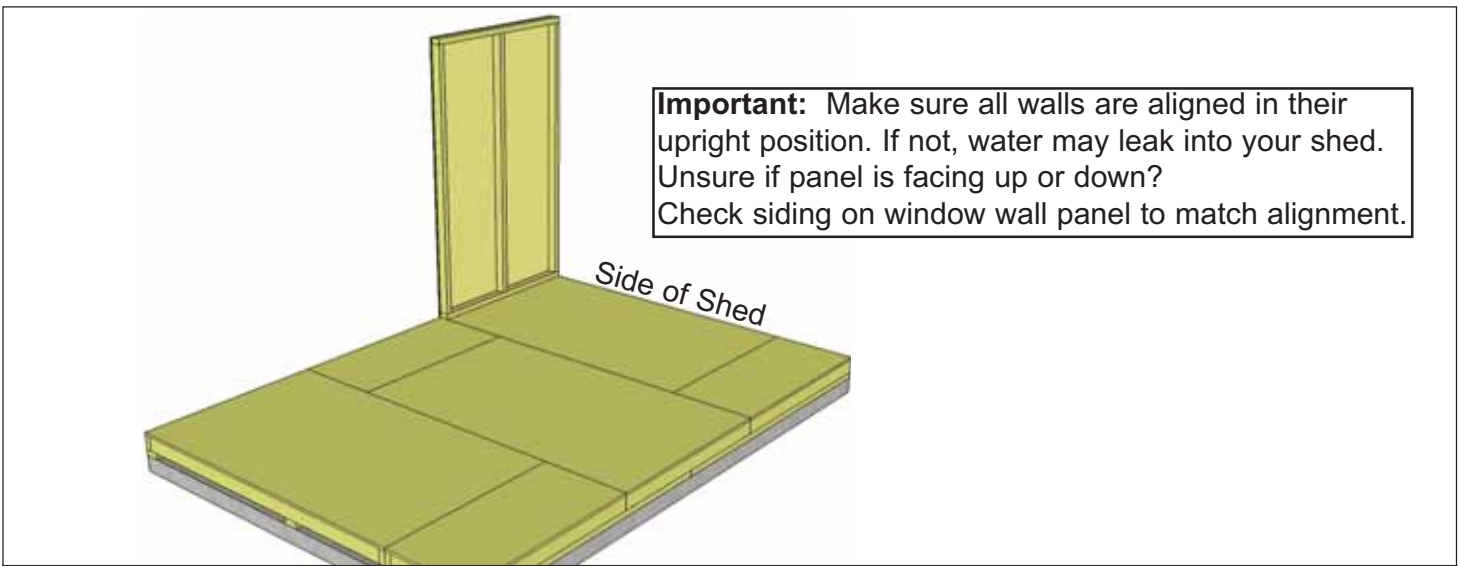

15. Starting at Rear Corner, position a Solid Wall Panel on top of plywood floor. The Wall Panel bottom framing will sit flush with plywood. Wall siding will overhang the floor.

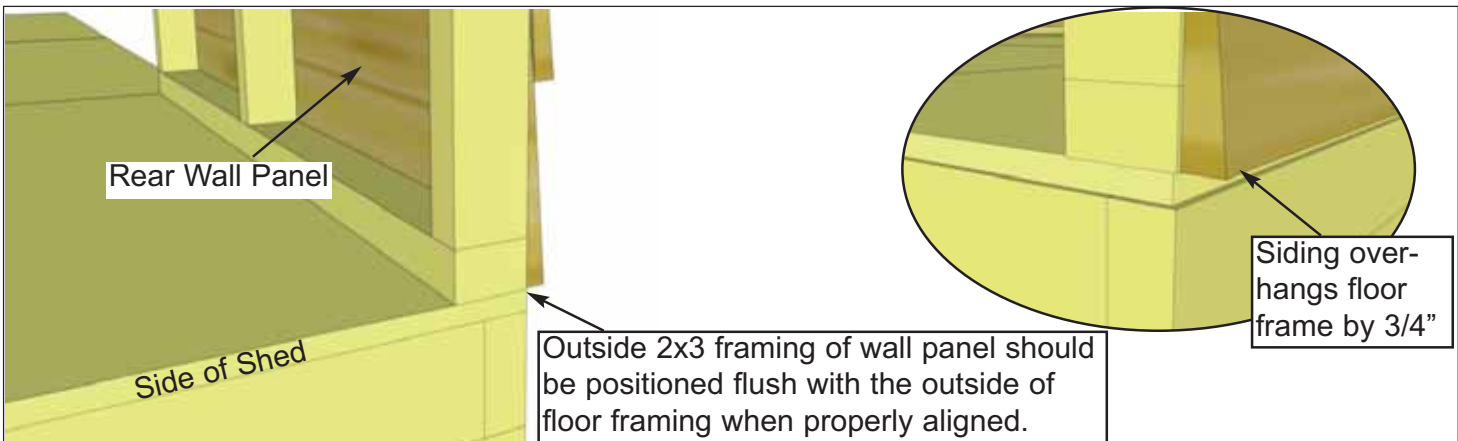

16. The rear wall panels will sit even with the floor frame and the sidewall panels will be sandwiched between the front and rear wall panels. The floor plywood may be slightly recessed.
Note: Siding will overhang the floor frame by approximately 3/4".

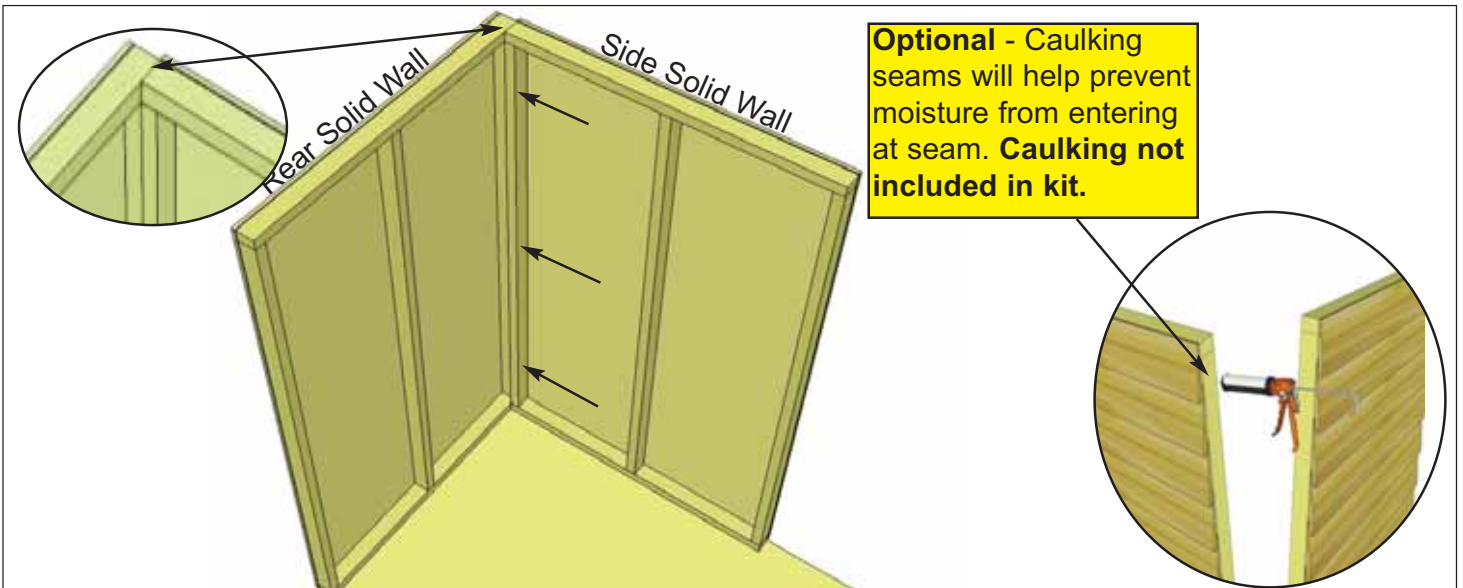

17. Position side solid wall into place on plywood floor. Butt both vertical wall studs of side and rear walls together and attach with **3 - 2 1/2" Screws**. Screw at the bottom, middle and top of stud to secure properly.

Hardware
S1 - 2 1/2" Screws
 x 3 total

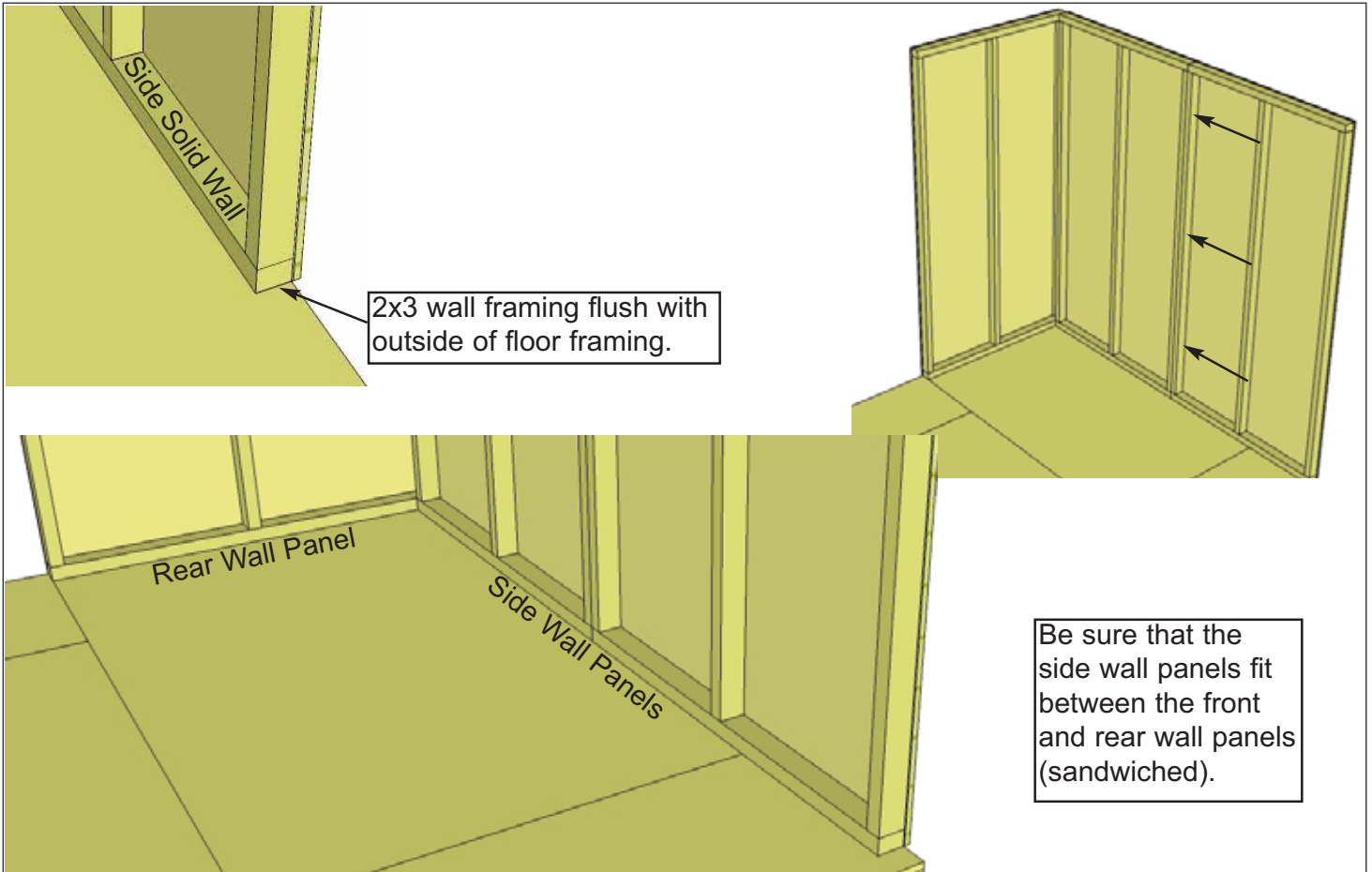

18. With the corner wall attachment complete, position a second side wall panel in place so bottom 2x3 wall framing is sitting flush with outside floor joists. Wall siding should overhang floor by approximately 3/4". When positioned correctly, attach both side wall panel studs together as per **Step 17**.

Hardware (Steps 18 - 20)
S1 - 2 1/2" Screws
 x 21 total

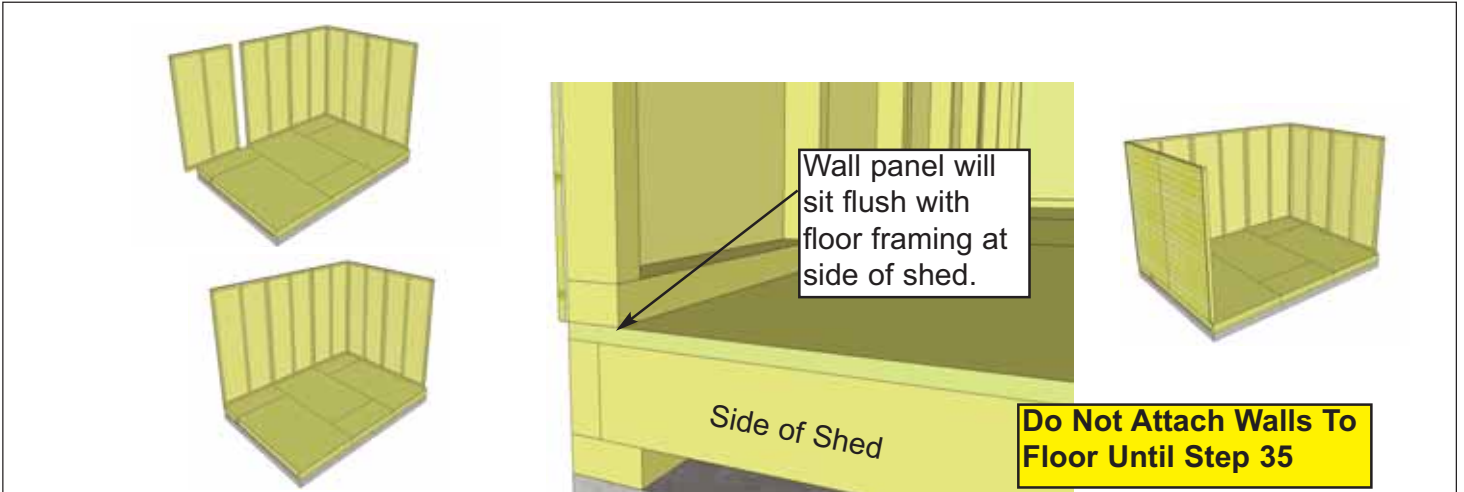

19. Complete all side and rear wall attachments as per **Step 17.**

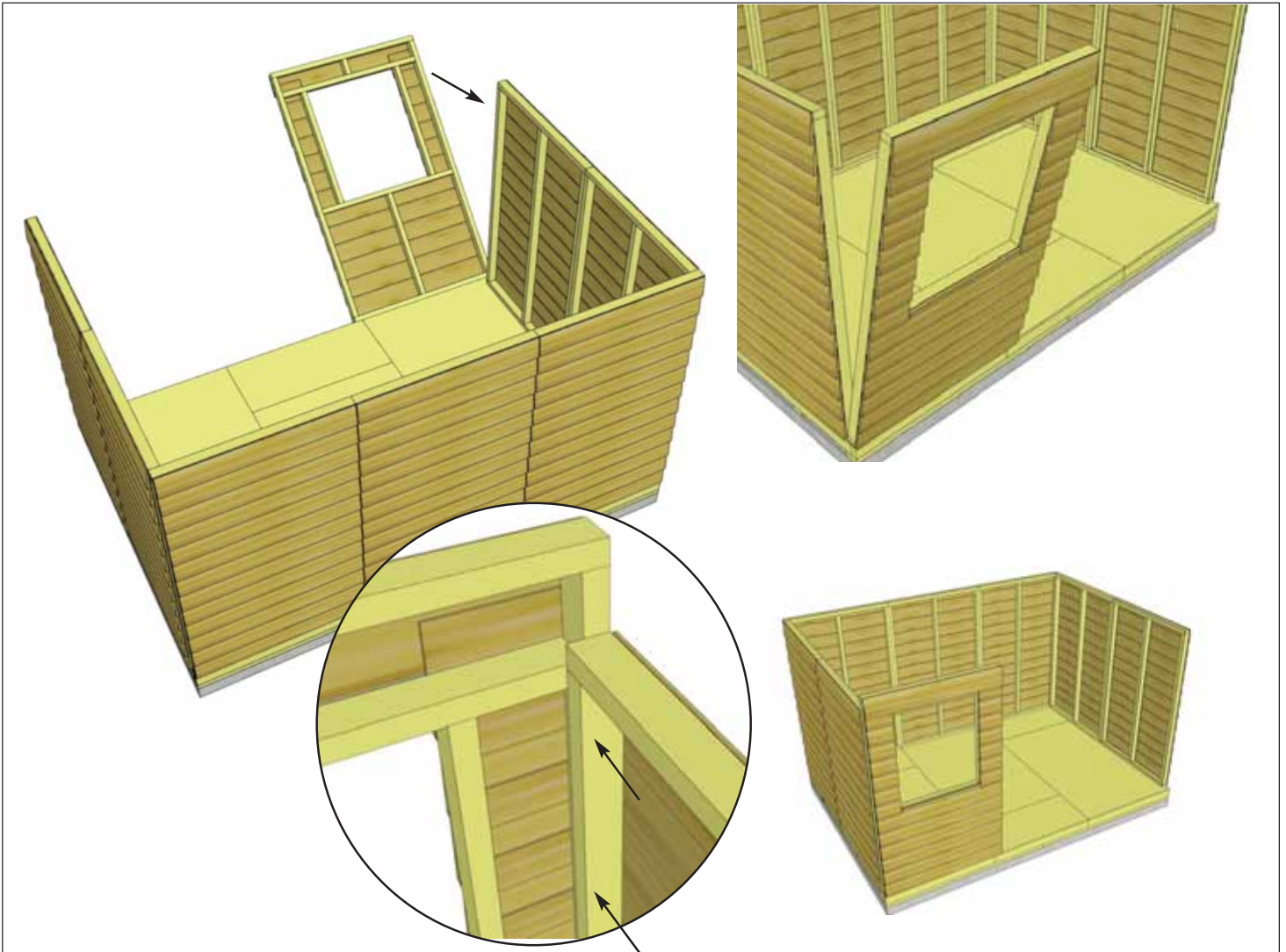

20. Place Window Wall Panel in front and attach as per **Step 17.**

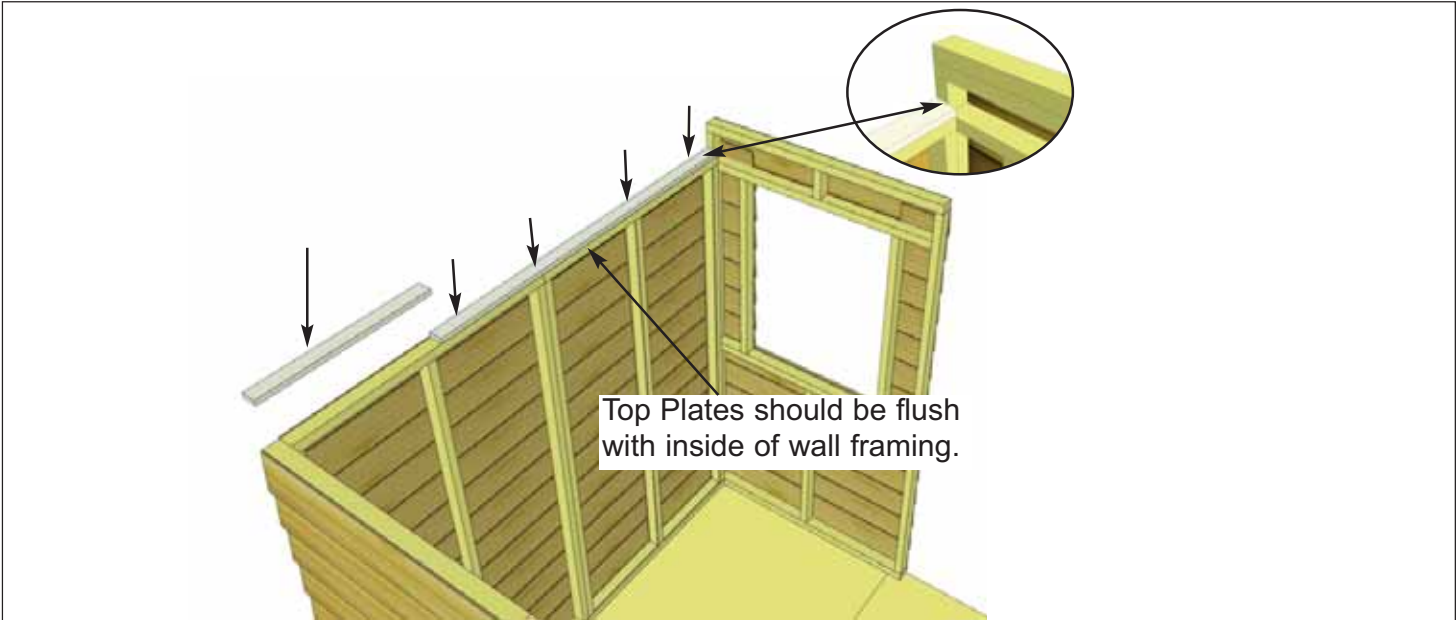

21. Position **2D & 2F - Main Wall Side Top Plates** on top of wall studs so they are flush on the inside with 2x3 wall stud. There are 2 plates per side - 1 long & 1 short. Attach by screwing down into top wall framing with **4 - 2" Screws** per long plate & **3 - 2" Screws** per short plate.

<u>Parts</u>	
2D - Main Wall Side Top Plates (3/4" x 2 1/2" x 65 3/4") x 2	
2F - Main Wall Side Top Plates (3/4" x 2 1/2" x 27 3/4") x 2	
<u>Hardware</u>	
(S3 - 2" Screws) x 14 total	

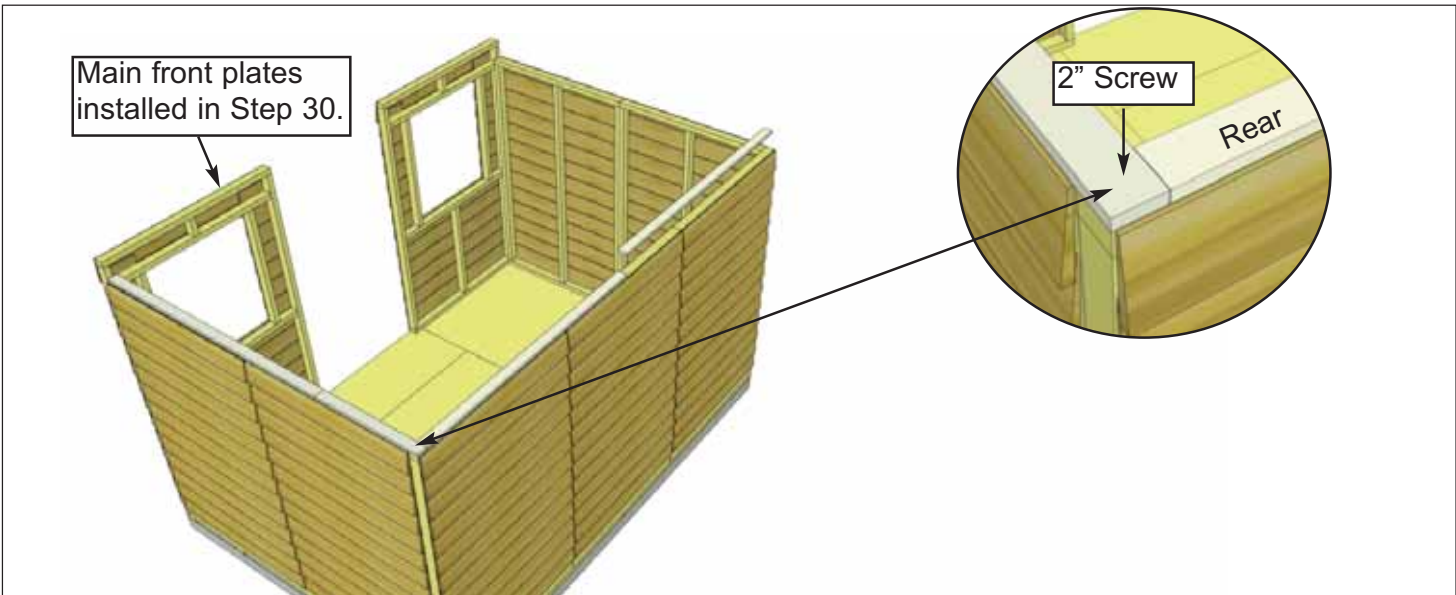

22. Attach both **2D - Main Wall Rear Top Plates** with **4 - 2" screws** per piece. Complete remaining side wall plates as per **Step 21**.

<u>Parts</u>	
2D - Main Wall Rear Top Plates (3/4" x 2 1/2" x 65 3/4") x 2	

<u>Hardware</u>	
S3 - 2" Screws x 8 total	

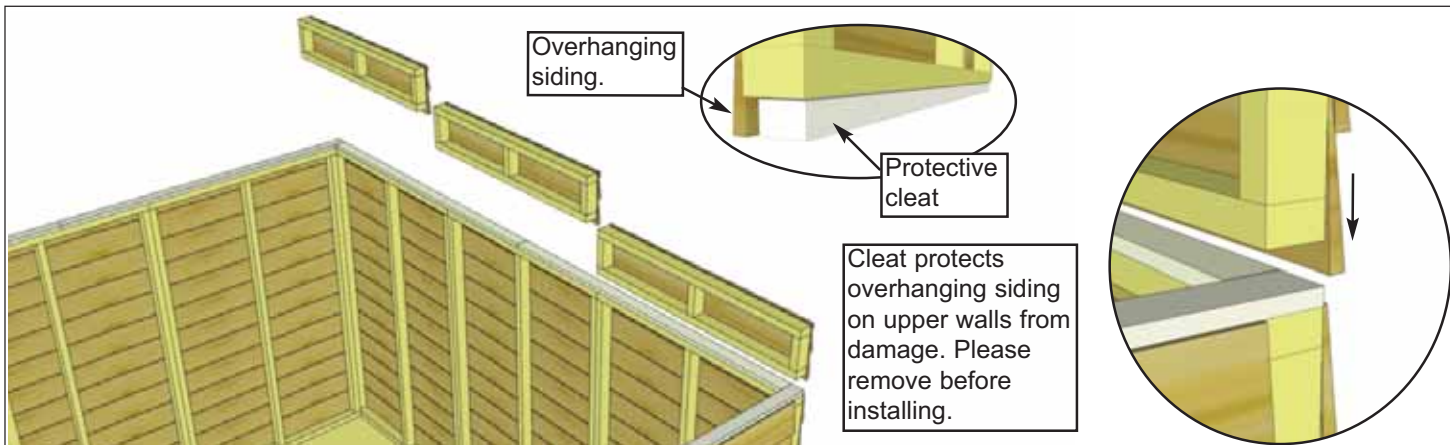

23. Place **2G - Rear Extender Walls** on rear wall plate with bottom siding overlapping that of the rear wall.

Parts (Steps 23 - 24)
2G - Rear Extender Walls
 (2G - 45 1/2" wide) x 3

Hardware (Steps 23 - 24)
S1 - 2 1/2" Screws
 x 12 total

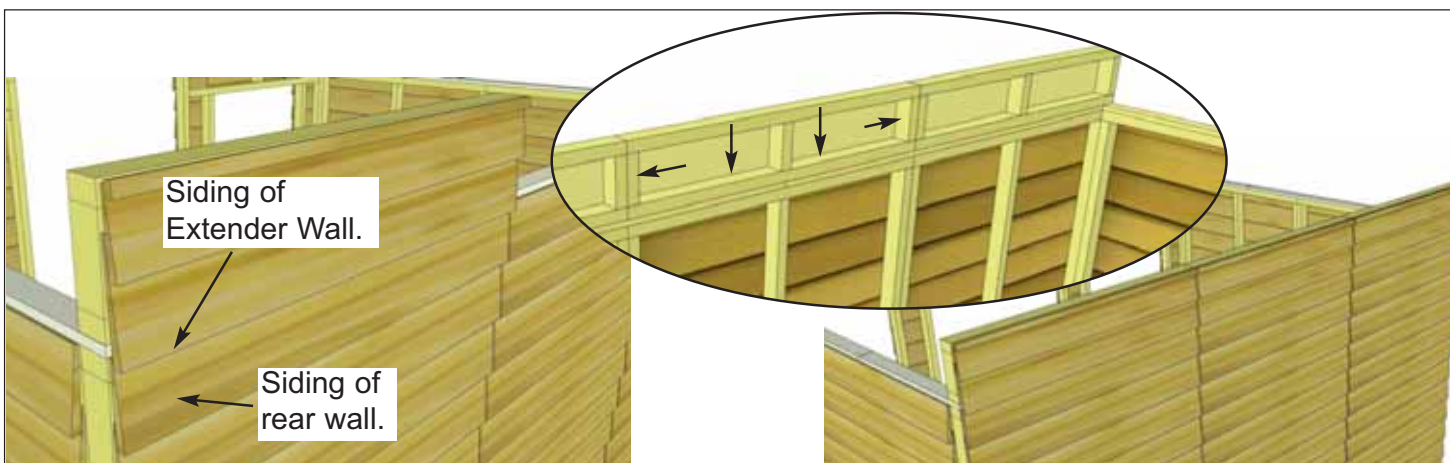

24. With 2x3 wall framing aligned, attach extender walls to rear wall top plate with **4 - 2 1/2" Screws** per wall.

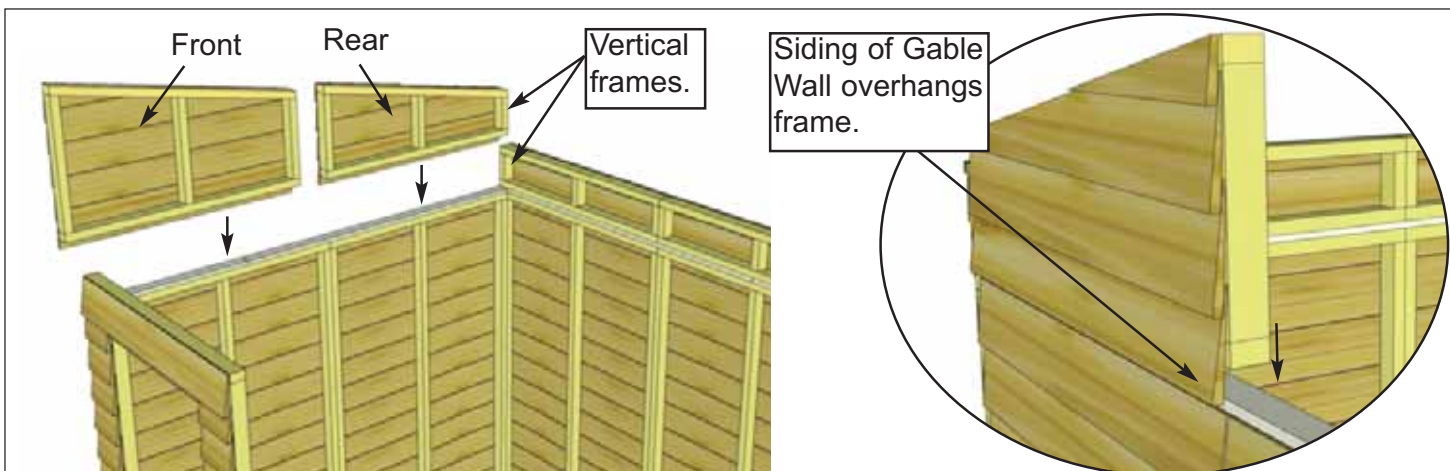

25. Position bottom frame of **2H - Rear Side Gable Wall** onto side wall top plate. Align so gable wall and side wall 2x3's are even. Rear gable vertical frame will sandwich against extender vertical frame.

Parts (Steps 25 - 27)
2H - Rear Side Gable Walls
 (2H - Right/Left Pair) x 2
2I - Front Side Gable Walls
 (2I - Right/Left Pair) x 2

Hardware (Steps 25 - 27)
S1 - 2 1/2" Screws
 x 22 total

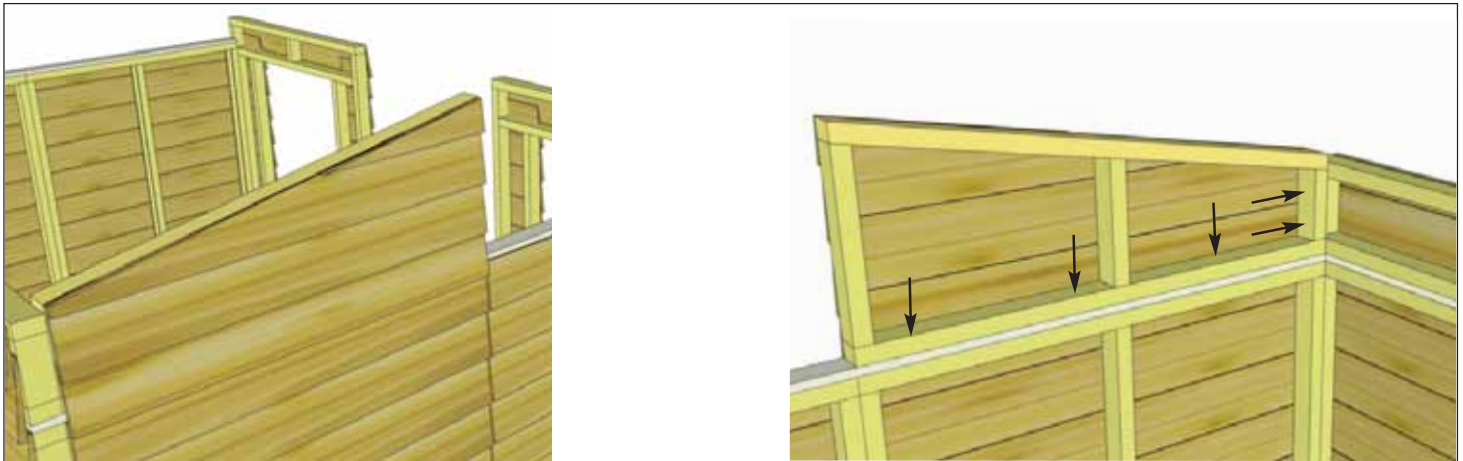

26. From the outside, siding of gable will overlap side wall. When aligned, secure gable with **5 - 2 1/2" Screws**. On a ladder, push extender wall and gable wall together tight and then screw.

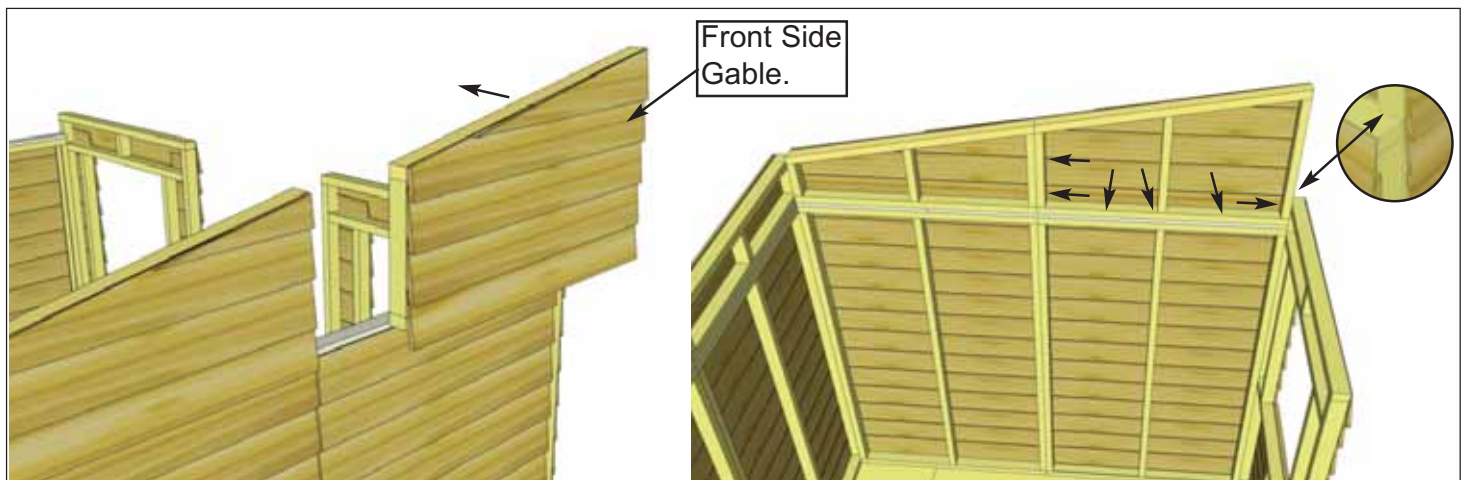

27. Position bottom frame of **2I - Front Side Gable Wall** onto side wall top plate. Align so gable wall and side wall 2x3's are even. Front gable vertical frame will sandwich against front window wall vertical frame. When correctly aligned, attach with **6 - 2 1/2" Screws**. Complete other side the same.

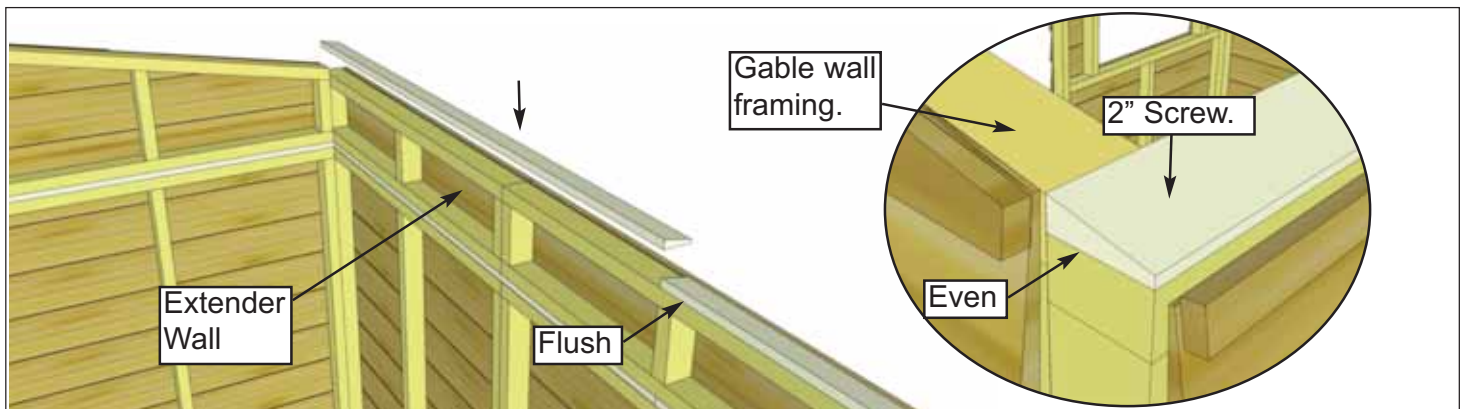

28. Position **2K - Rear Upper Wall Plates** on rear extender wall framing, flush with inside of extender framing and even with outside wall. Attach each piece with **4 - 2" Screws**.

<u>Parts</u>
2K - Rear Upper Wall Plates - 11° angle on face (3/4" x 2 1/2" x 68 1/4") x 2
<u>Hardware</u>
(S3 - 2" Screws) x 8 total

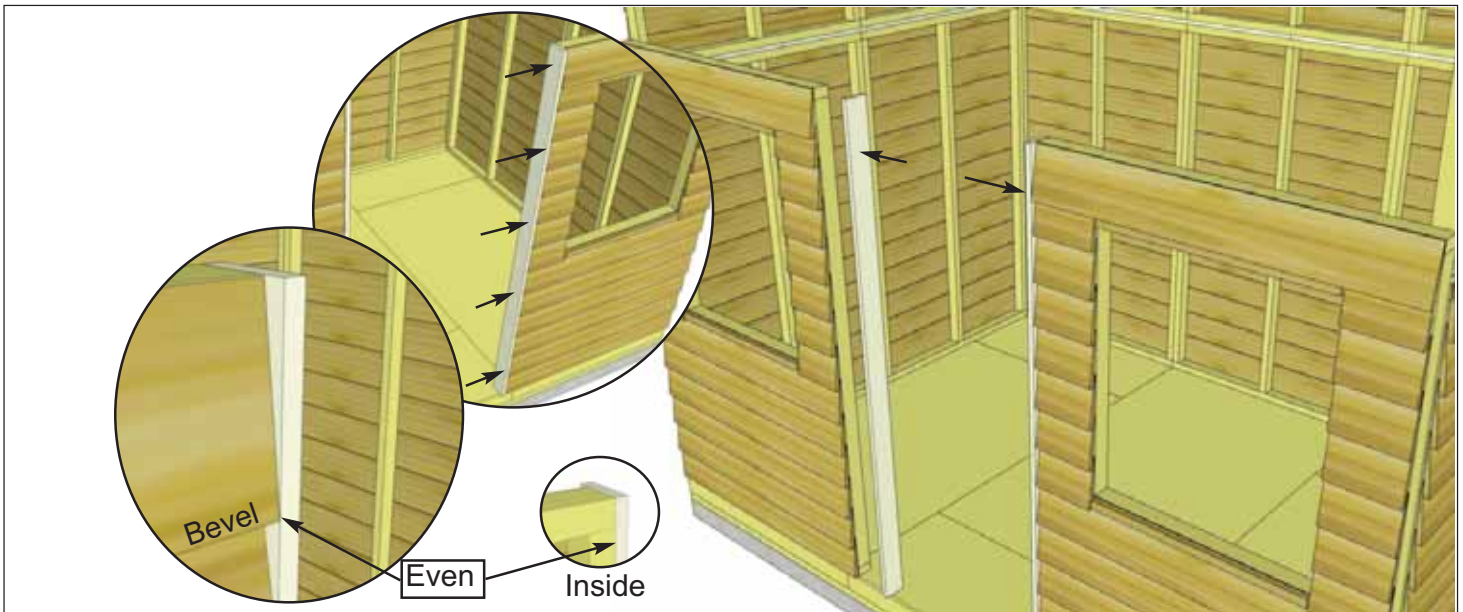

29. Position **2L - Door Jambs** against window wall vertical framing. Jamb should sit even with the thick bevel siding on the outside and even with framing on the inside. Attach with **5 - 2 1/2" Screws** / piece.

Parts 2L - Door Jambs (3/4" x 3 3/8" x 80 1/4") x 2
Hardware (S1 - 2 1/2" Screws) x 10 total

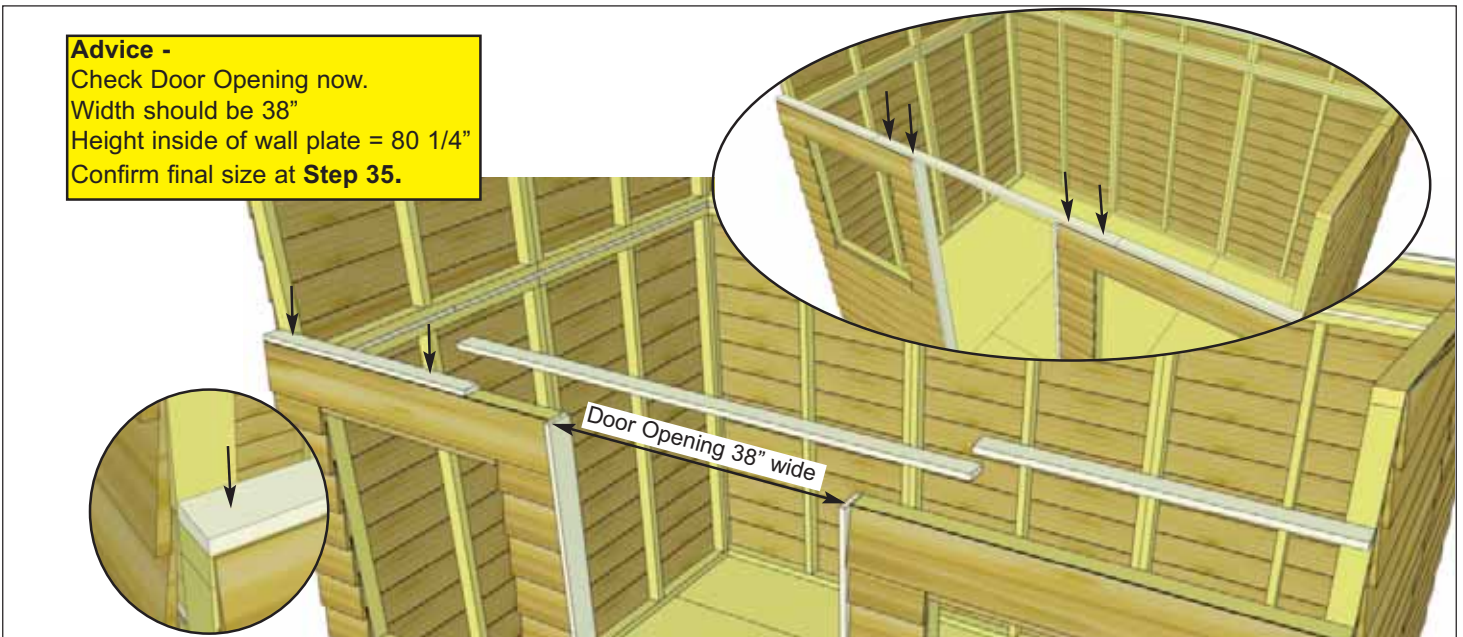

30. Position **2D & 2E - Main Wall Front Top Plates** on top of window wall framing so they are flush on the inside with 2x3 wall stud. Align plates on wall as per **Step 21**. There are 2 outside smaller plates (**2E**) and 1 longer center plate (**2D**). Attach by screwing down into top of wall framing with **2 - 2" Screws** per shorter plate and **4 - 2" Screws** on the center plate.

Parts 2D - Main Wall Front Top Plate (3/4" x 2 1/2" x 65 3/4") x 1 2E - Main Wall Front Top Plates (3/4" x 2 1/2" x 35 5/8") x 2
Hardware (S3 - 2" Screws) x 8 total

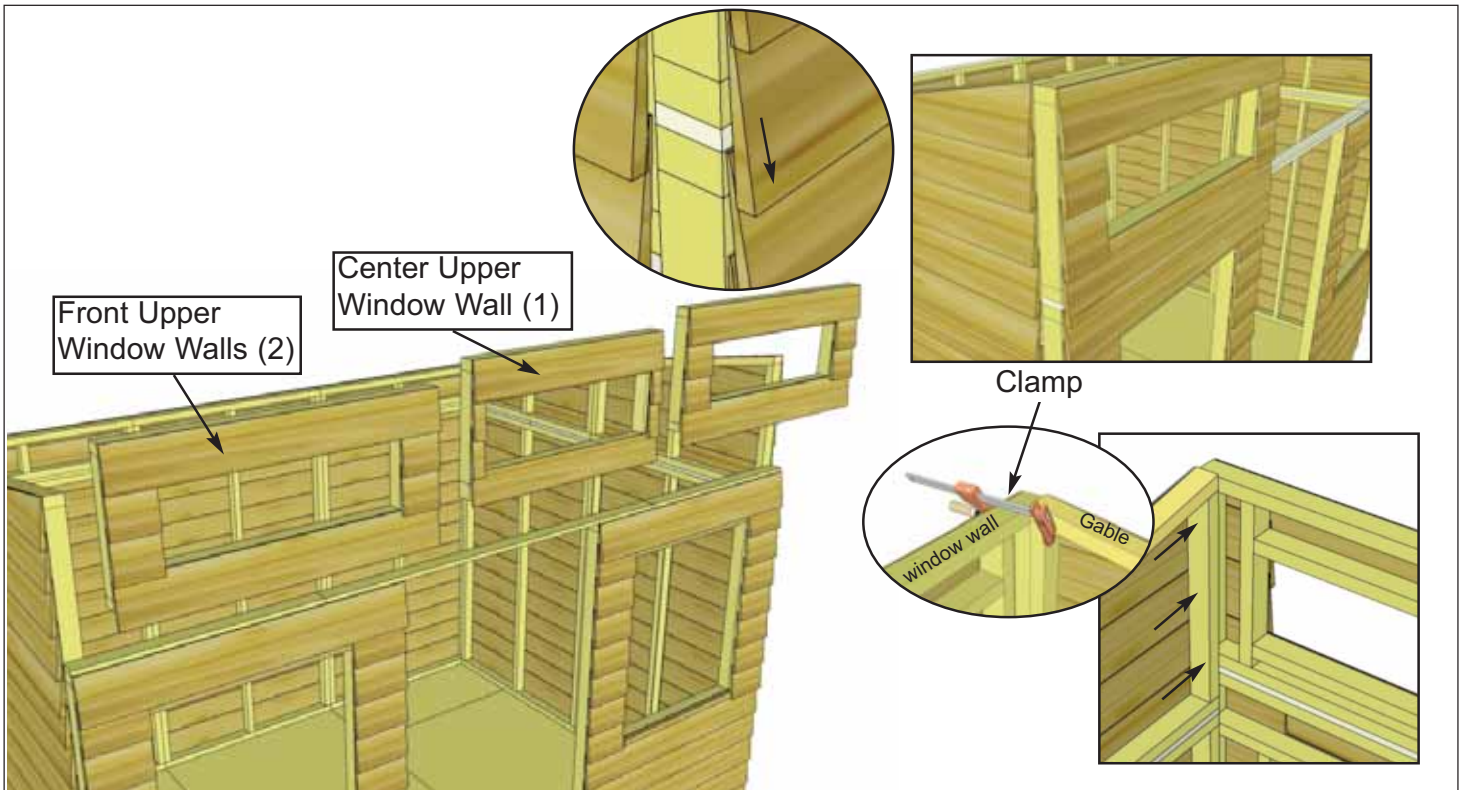

31. Starting with a **2M - Upper Front Window Wall - Side**, place on front main wall top plate in corner. Upper wall siding will overhang lower window wall siding. Line up vertical gable framing with upper window framing and clamp together. Screw frames together with **3 - 2 1/2" screws**.

- Parts (Steps 31 - 33)
- 2M - Upper Front Window Walls - Sides**
(2M - 48 1/2" wide) x 2
 - 2N - Upper Front Window Wall - Center**
(2N - 39 1/2" wide) x 1

Hardware (Steps 31 - 33)
(S1 - 2 1/2" Screws) x 21 total

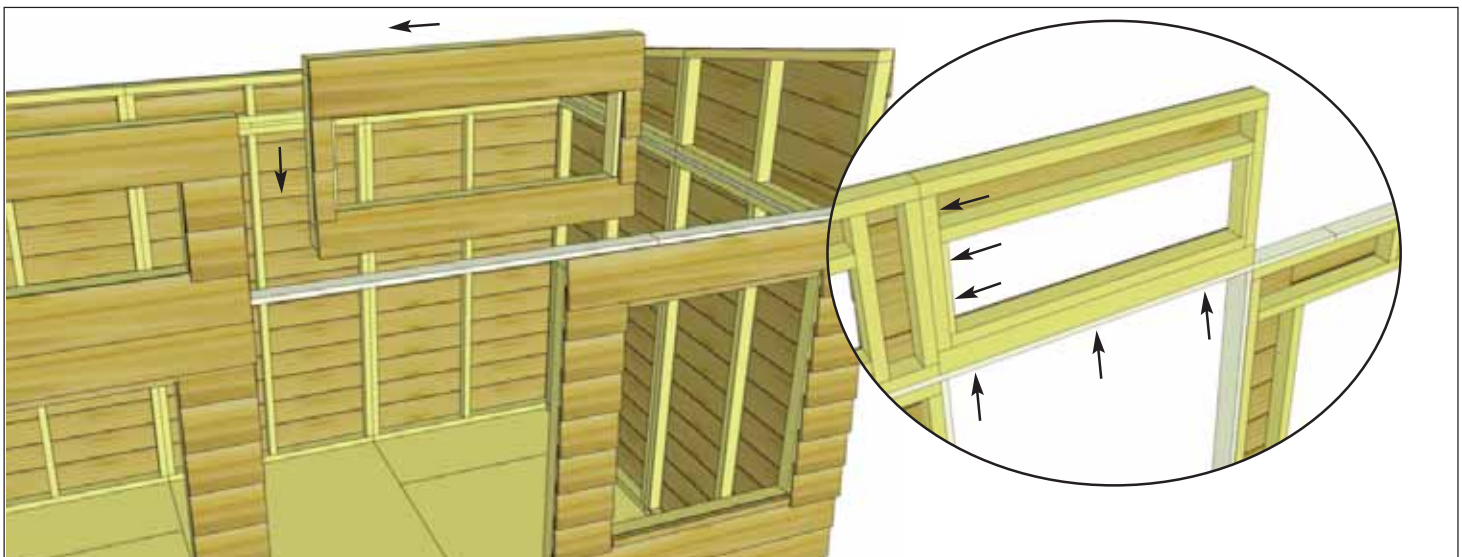

32. Position **2N - Upper Front Window Wall - Center** on front main wall top plate tight against the previously installed upper window frame. Line up vertical gable framings and screw frames together with **3 - 2 1/2" Screws**. Use clamp to keep frames together tight. From underneath, attach **3 - 2 1/2" Screws** from the plate into the bottom of the window frame.

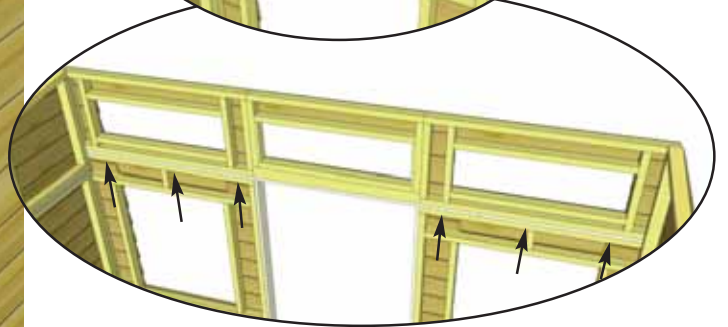
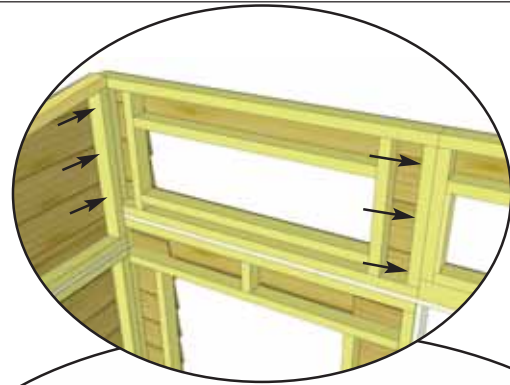

33. Position and attach the remaining **2M - Upper Front Window Wall - Side** on front main wall top plate in corner as per **Step 31**. Clamp frames together to keep frames tight. To complete, screw both outside upper window panels from underneath window wall framing with **3 - 2 1/2" Screws** per panel.

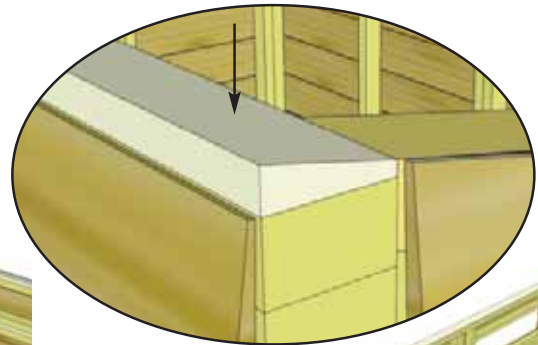
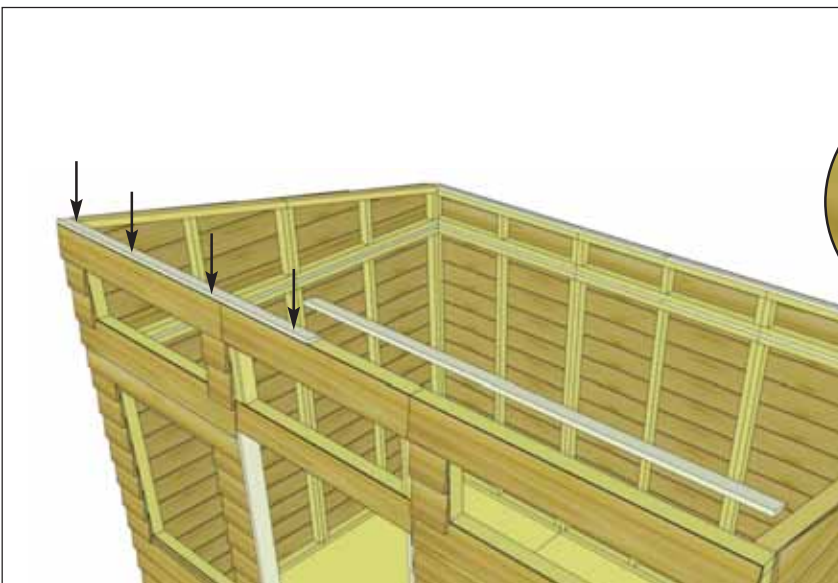

34. Position **2J - Upper Wall Plates** on upper front window wall framing as per **Step 28**. Attach each piece with **4 - 2" Screws**.

Parts
2J - Upper Wall Plates - 11° angle on face
 (3/4" x 2 1/2" x 68 1/4") x 2

Hardware
(S3 - 2" Screws) x 8 total

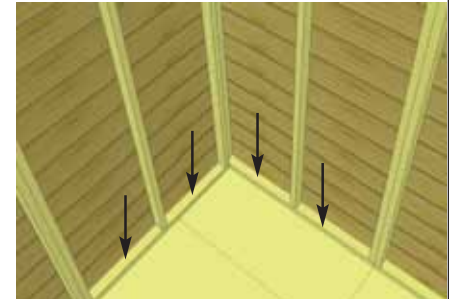
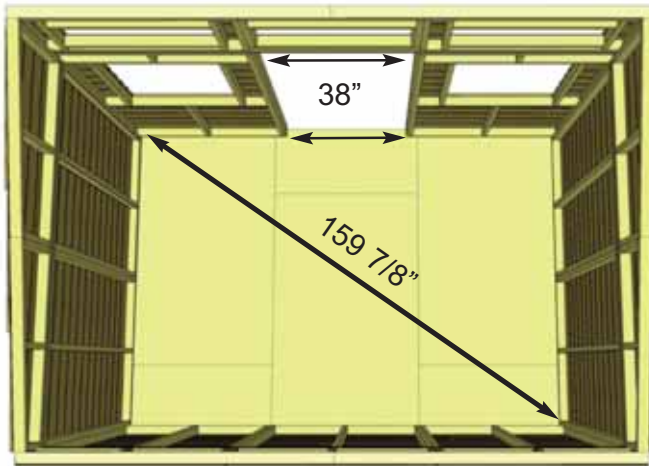

35. When all walls are attached together, check alignment with the floor. Bottom wall framing should sit flush with outside of floor framing. **Adjust for best fit.** Confirm 38" wide door opening at top and bottom. When positioned correctly, fasten bottom wall plates to floor using **4 - 2 1/2" Screws** per wall panel. Check diagonal measurement in each floor corner to confirm it is square.

Hardware
S1 - 2 1/2" Screws
 x 36 total

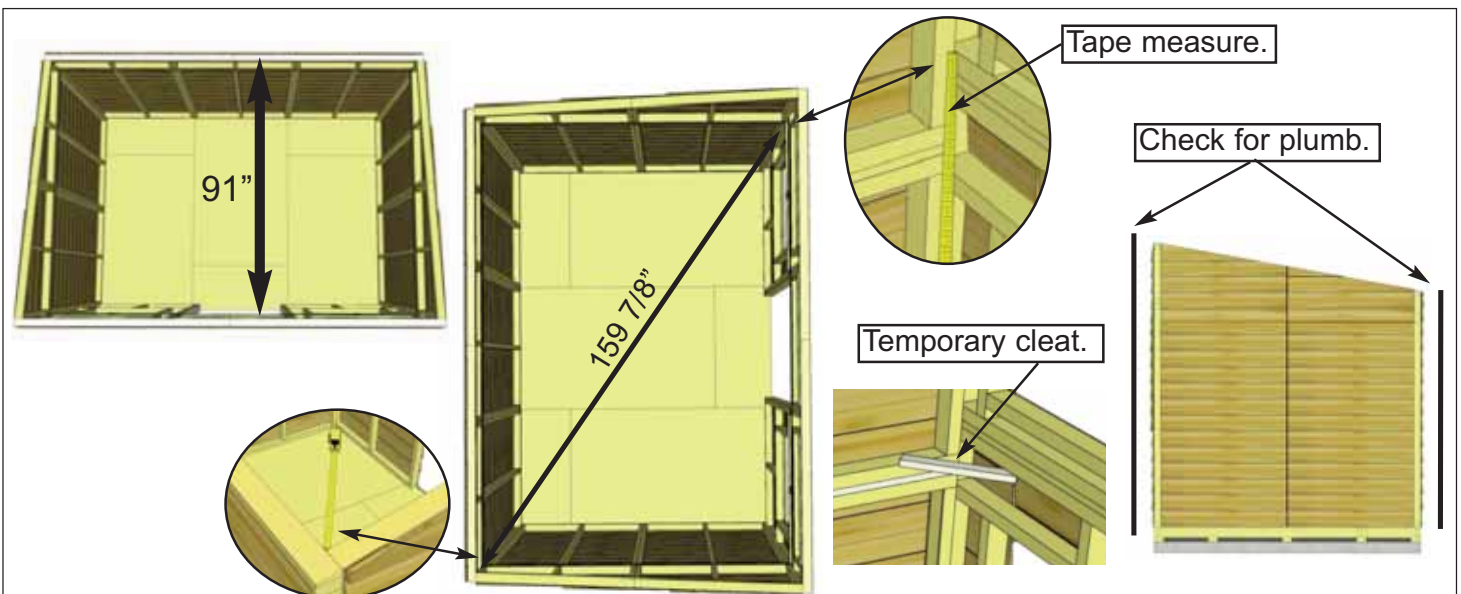

36. Prior to installing rafters, take time to confirm your walls are level, square and plumb. Measure diagonal at the height of back wall to opposing corner for square. If not within 1/2", your walls are not square. Adjusting now will make it easier to install the roof section. Make sure front to rear inside frame width is 91". Also check walls for plumb. Tip - once satisfied, cleat each corner temporarily with some scrap wood (not included) to keep walls from moving.

3. Rafter & Roof Section

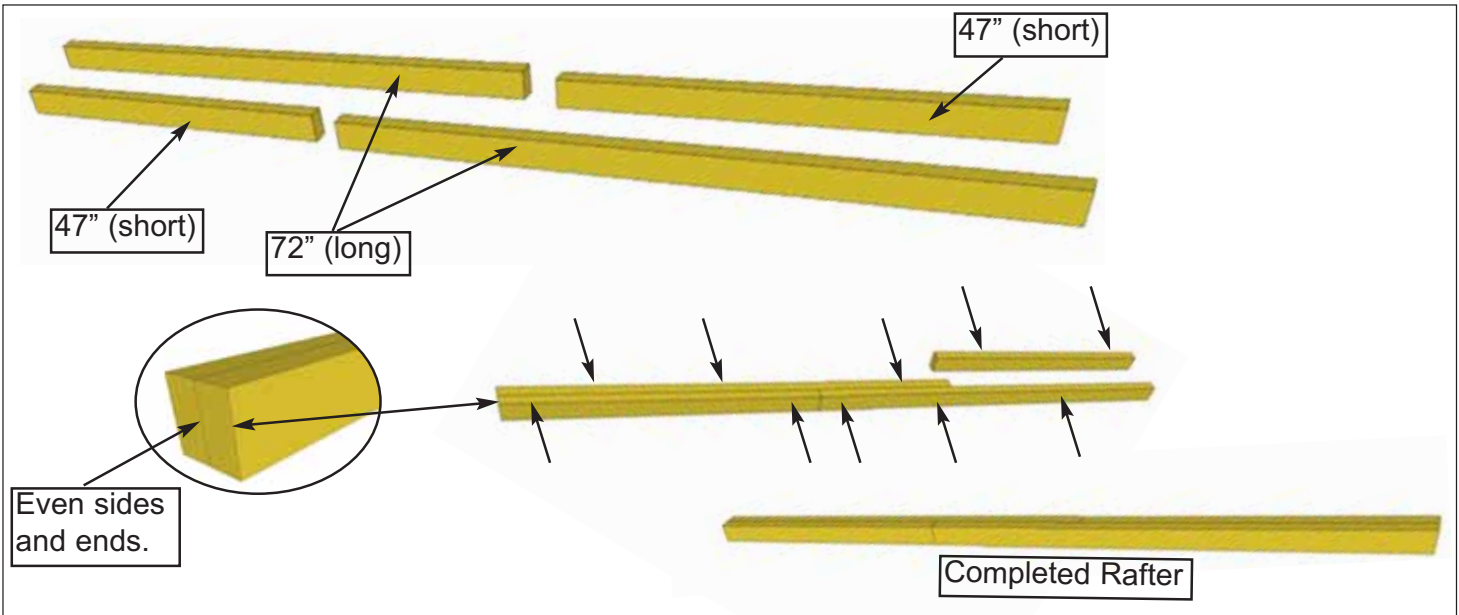

37. Rafters need to be assembled before laying of roof. There will be 7 completed rafters when pieces are attached together. There are 4 pieces of "2x4" for each rafter. **2 pcs of 47" Length & 2 pcs of 72" Length.** When attached together, total length of rafter will be 119". On solid ground, locate 2 of **3A - Rafter Sections -Short** and 2 of **3B - Rafter Sections -Long** and position as illustrated above. Starting on one side, line ends and sides up even. Use clamp to hold in position. Attach together with **10 - 2 1/2" Screws.**

- Parts (Steps 37 - 38)
3A - Rafter Sections -Short
 (1 1/2" x 3 1/2" x 47") x 14
3B - Rafter Sections -Long
 (1 1/2" x 3 1/2" x 72") x 14
Hardware (Steps 37 - 38)
S1 - 2 1/2" Screws
 x 70 total



38. Complete attachments of all 7 Rafters now.

Hint - Occasionally wood can twist, use clamps to straighten as best you can before screwing.

Important
 You will need two large ladders (7 ft or 8ft high) during most of the remaining steps of this manual.

39. Before attaching rafters measure between gable wall framing. Make sure distance between inside framings is 131 1/2". Be sure to evenly space rafters on framing before attaching in **Step 40.**

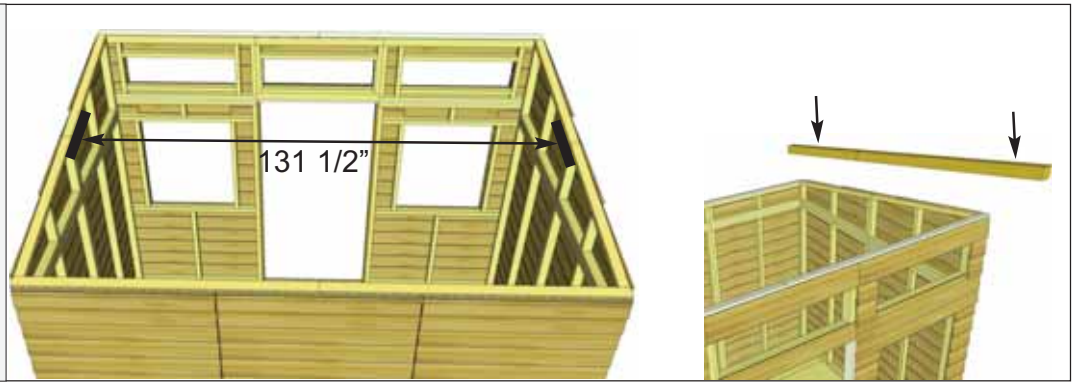

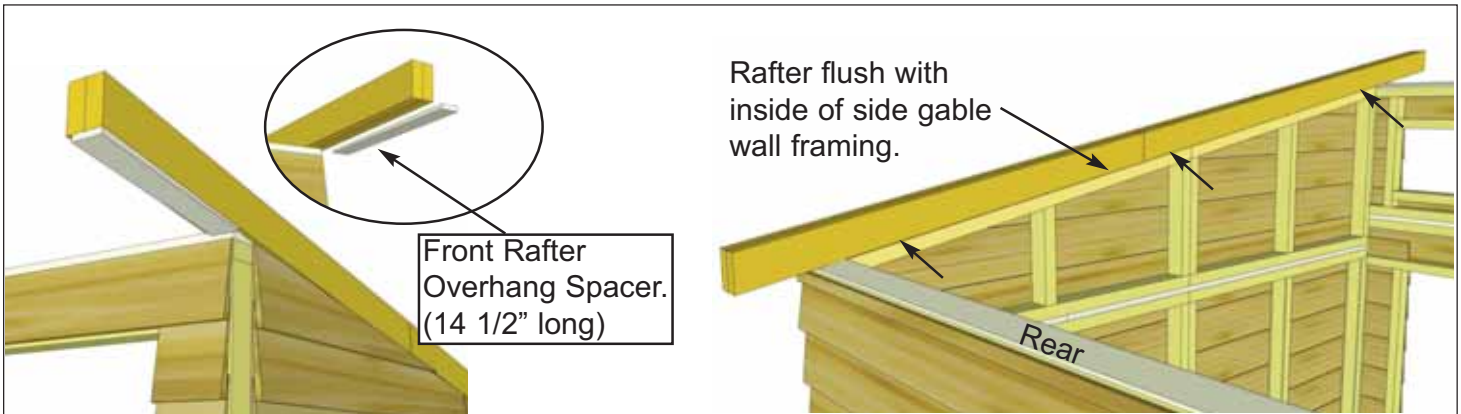

40. Position Rafter on gable wall framing. Locate **3F - Rafter Overhang Spacer** and place underneath front of rafter flush against upper wall plate to determine front rafter overhang position. Inside of rafter should sit flush with inside of gable wall framing. Clamp in position but don't attach yet. Position opposite outside rafter as described and clamp in place as well.

Parts
3F - Rafter Overhang Spacer
 (3F - 14 1/2" length) x 2

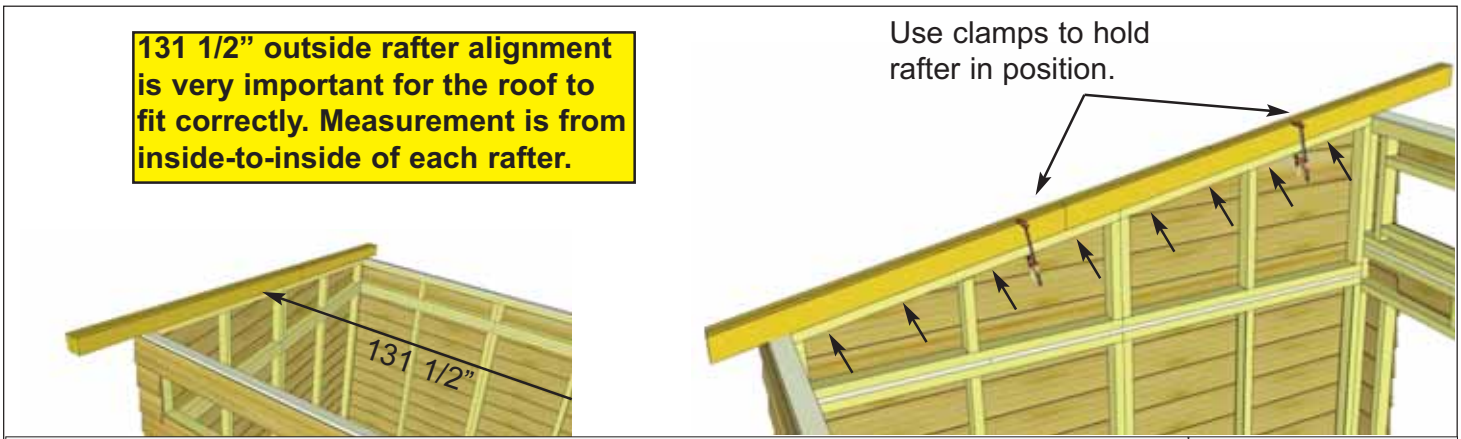

41. Before attaching, measure rafter spacing to confirm 131 1/2" and make adjustments as necessary. With Rafter correctly positioned, attach to side gable wall framing with **8 - 2" Screws**. Screw up from below the framing into rafter. Position other outside rafter as above. Inside to inside measurement of rafters should be 131 1/2".

Hardware
S3 - 2" Screws
 x 16 total

42. Lift and place remaining 5 rafters on upper wall plates. Space equally apart for now.

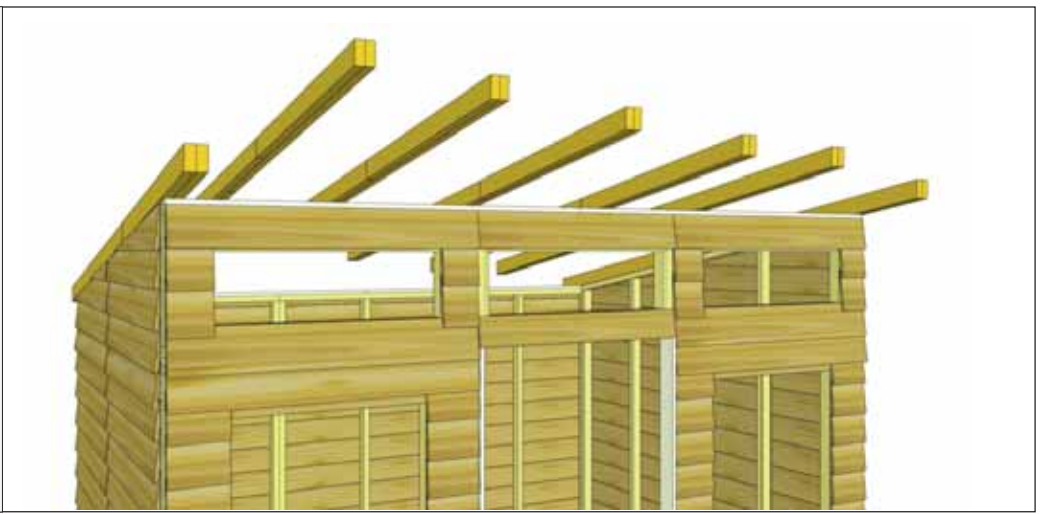

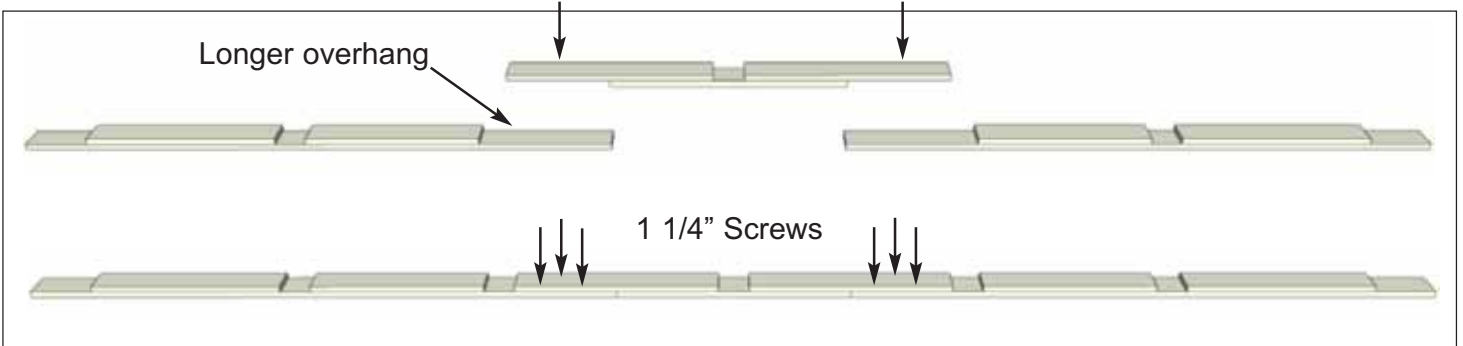

43. To assist in rafter alignment, you will need to assemble the Rafter Spacer Jig (3 pcs made with plywood). Align the center piece with the longer overhang of the side pieces as shown above. Attach with **3 - 1 1/4" Screws** in a triangular formation per side. After using Spacer Jig to align the rafters in **Steps 44 & 46**, it will be permanently fastened to the center of the roof in **Step 48**.

Parts
3D - Plywood Rafter Spacer Jig - Sides
 (2 1/2" x 68 3/4") x 2
3E - Plywood Rafter Spacer Jig - Center
 (2 1/2" x 48") x 1

Hardware
S2 - 1 1/4" Screws
 x 6 total

44. Place completed Rafter Spacer Jig on top of the roof rafters in the front. Position interior rafters so they fit in jig spacers as shown to the right. Use the Front Rafter Overhang Spacer to correctly position rafters from front to rear.

Expert Advice - prior to attaching rafters, refer to **Step 36** and check that walls are still level, square and plumb.

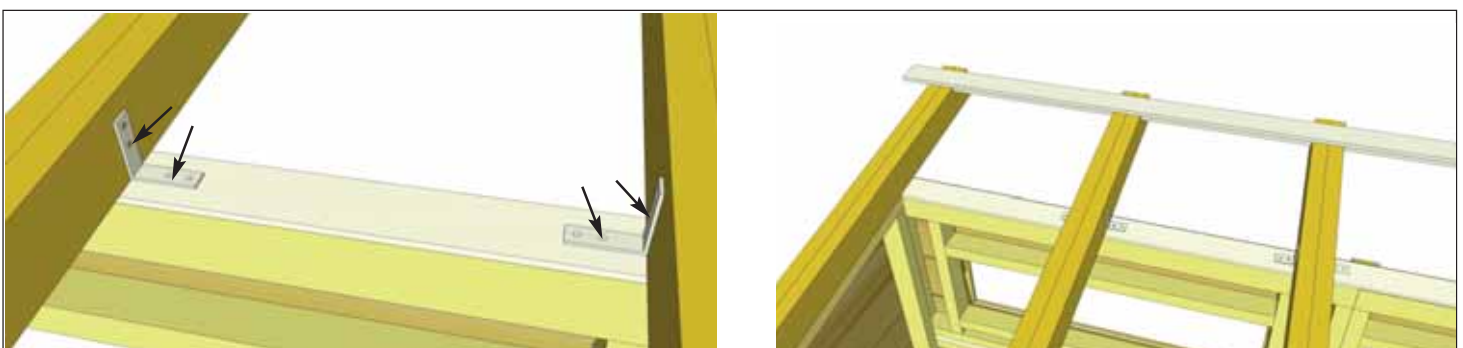
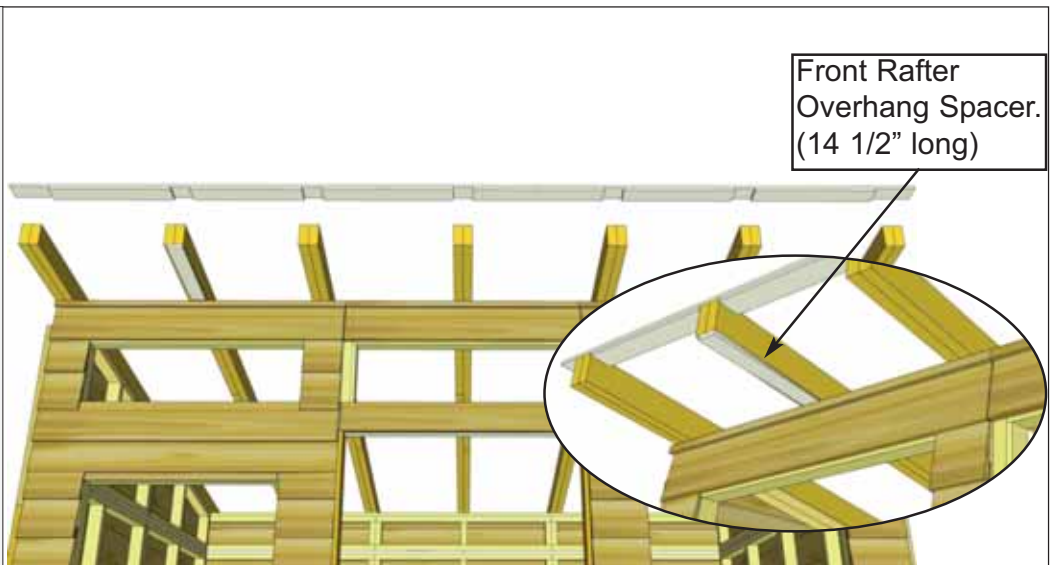

45. With Rafter correctly positioned using the overhang spacer, attach a **90° Metal Bracket** to each side of rafter and to the front upper wall top plate. Use **4 - 1 1/4" Screws** per bracket. Proceed to next rafter. Use overhang spacer to position rafters correctly front to back and attach with two 90° brackets as described. Complete all remaining front interior rafter attachments.

Hardware
S2 - 1 1/4" Screws
 x 40 total
Y2 - 90° Metal Bracket
 x 10 total

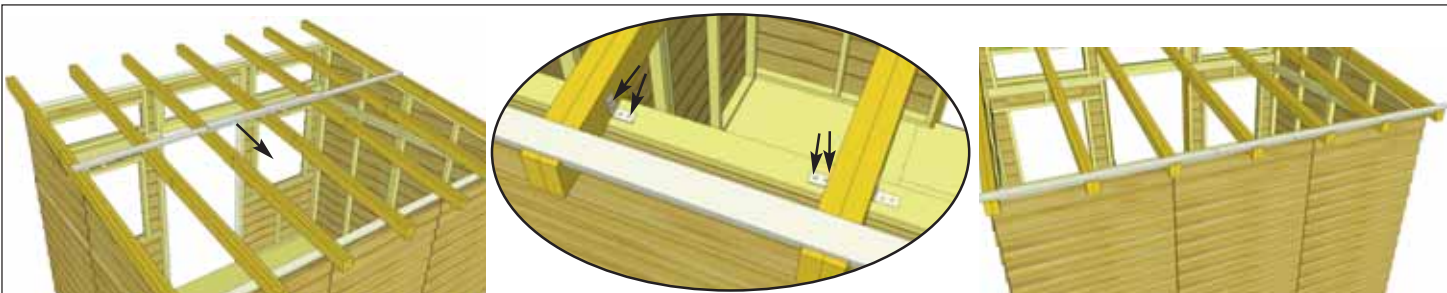

46. Slide Rafter Spacer Jig down to the rear. attach a **90° Metal Bracket** to each side of rafter and to the rear wall top plate. Use **4 - 1 1/4" Screws** per bracket. Complete all rear attachments of remaining interior rafters.

Hardware
(S2 - 1 1/4" Screws) x 40 total
(Y2 - 90° Metal Bracket)
 x 10 total

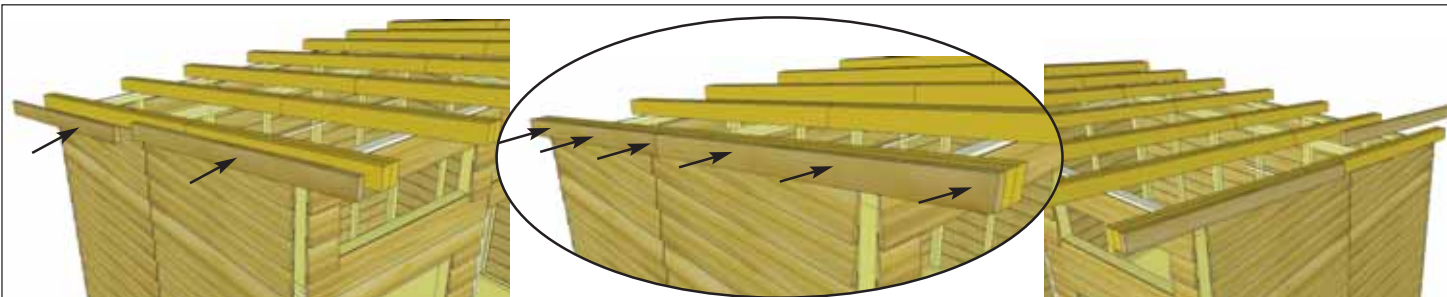

47. Locate **3C - Rafter Facia**. Position 2 pcs on outside rafter carefully lined up with ends and sides. Attach each piece with **3 - 2 1/2" Screws**. Complete both sides.

Parts
3C - Rafter Facia
11° angle cut ends
(1 1/2" x 2 1/2" x 59 1/2") x 4

Hardware
(S1 - 2 1/2" Screws)
 x 12 total

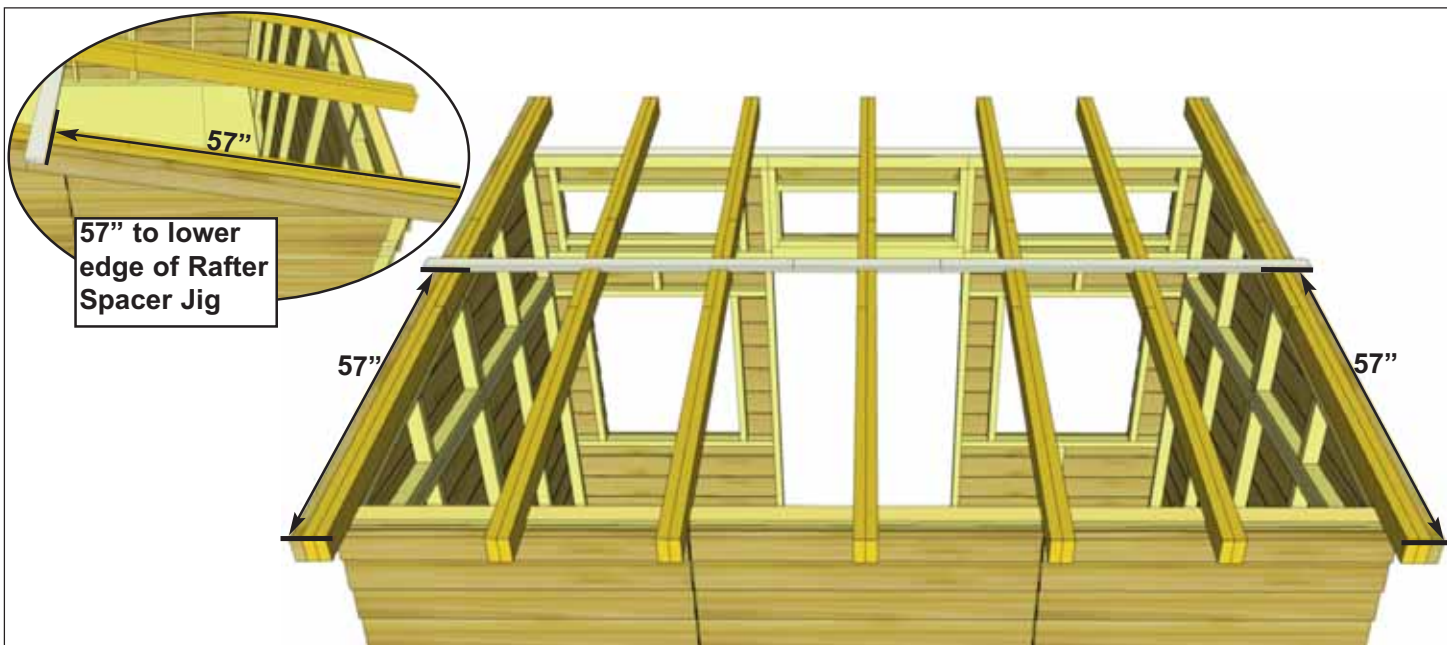

48. Measure 57" from the rear of outer left and right rafters and mark location to fasten Rafter Spacer Jig. This will help stabilize the rafters and make it easier to put the roof panels on in **Step 50**. Check Squareness of walls again as in **Step 36** before fastening rafters.

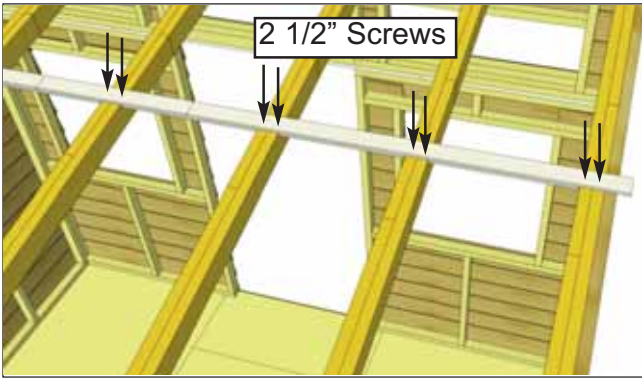

49. Screw down Rafter Spacer Jig onto Rafters with **2 - 2 1/2" Screws** per rafter assembly.

Hardware
S1 - 2 1/2" Screws
 x 14 total

Exploded view of Metal Roof section.

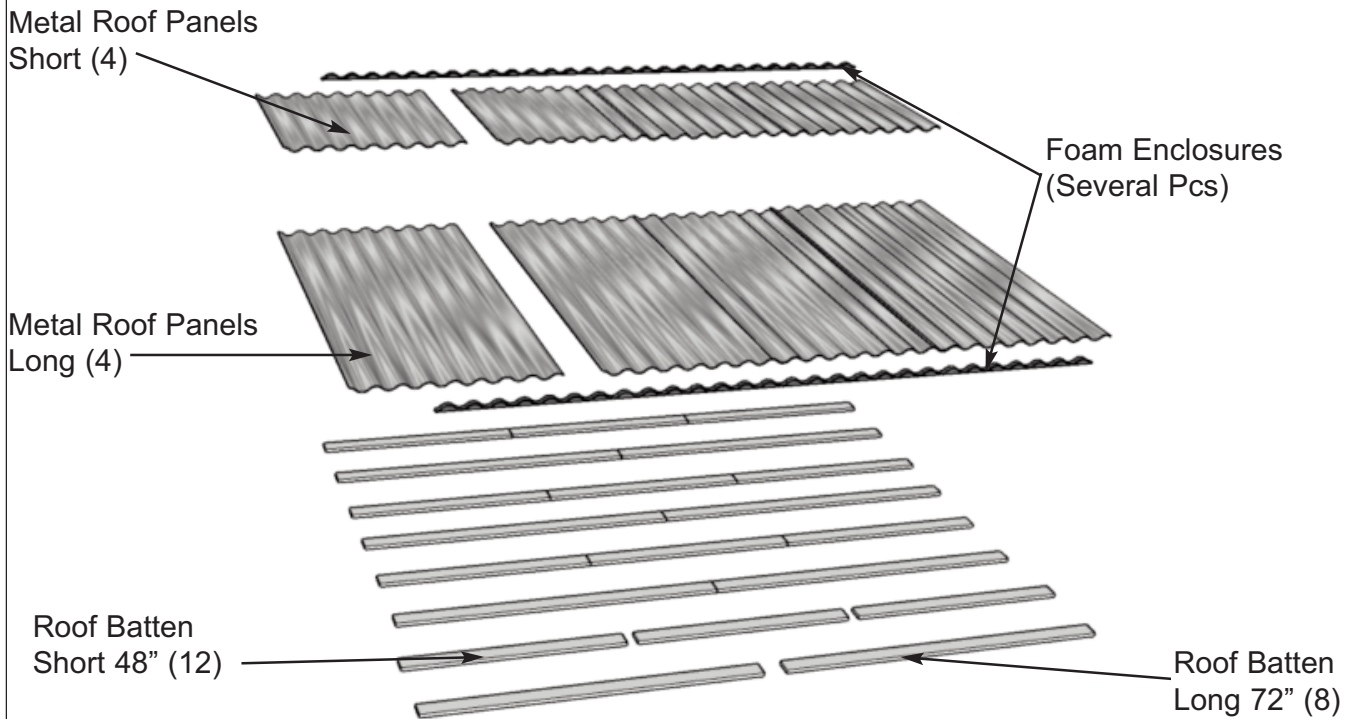

Completed view of Battens

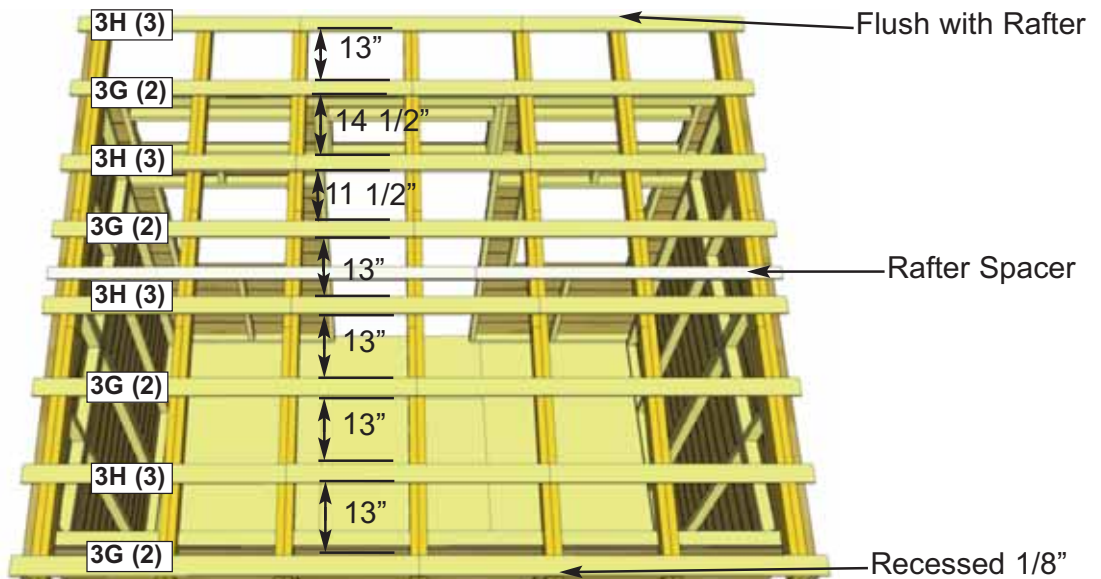

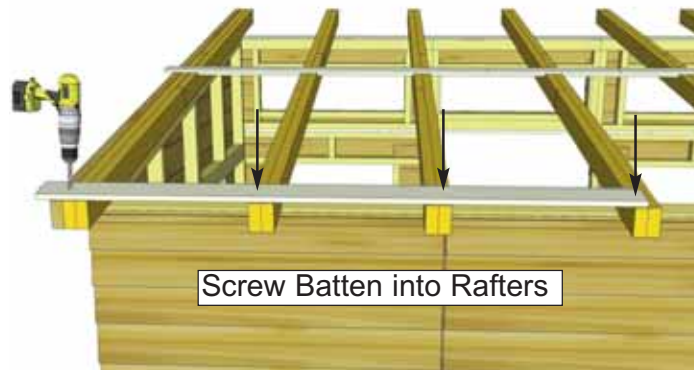
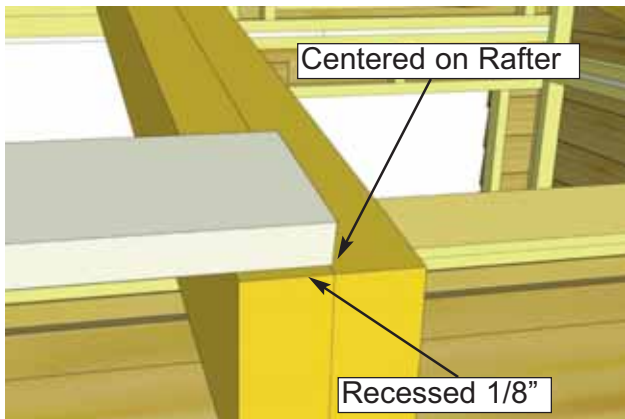
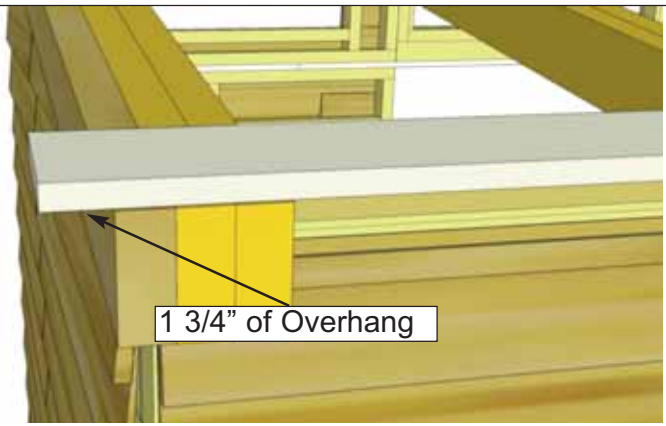
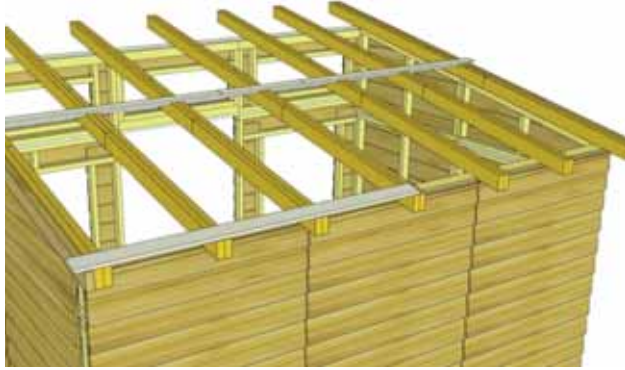

50. Locate **3G - Long Roof Battens** and start at the rear of shed. Place Batten on Rafters. Batten should be recessed 1/8" from end of Rafters. Batten should be centered on middle Rafter. Batten will overhang edge of Rafter Facia by approximately 1 3/4" when centered on middle Rafter. Pre-drill pilot holes with an 1/8" bit to prevent splitting. Secure Batten to Rafters with **4 - 1 1/4" screws**.

Parts (Steps 50 - 59)
3G - Roof Batten (Long)
 (3/4" x 3 1/2" x 72") x 8
3H - Roof Batten (Short)
 (3/4" x 3 1/2" x 48") x 12
 Hardware
49 - 1 1/4" Screws

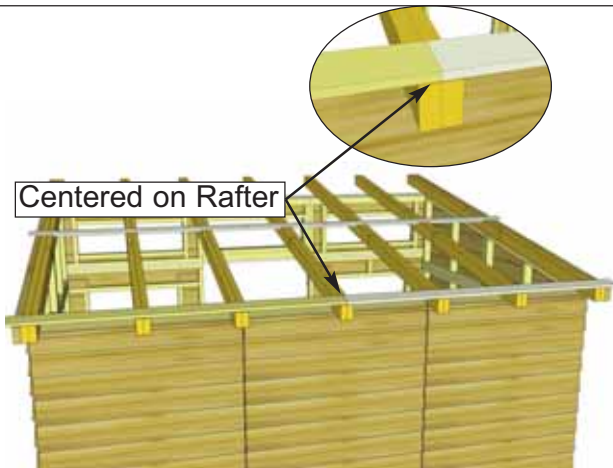

51. Place and attach 2nd **Long Roof Batten** following **Step 50**.

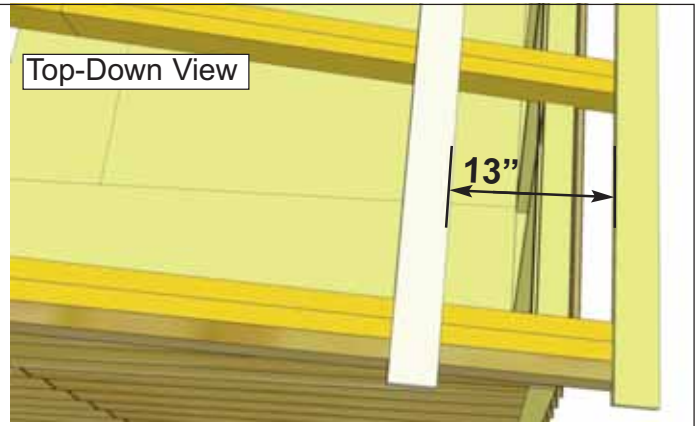
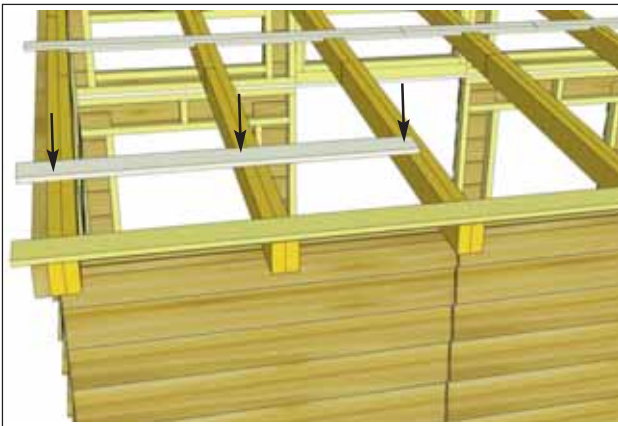

52. Locate **3H - Roof Batten Short**. Place Batten on Rafters 13" up from first Batten. Pre-drill pilot holes with 1/8" bit. Secure with **3- 1 1/4" screws**.

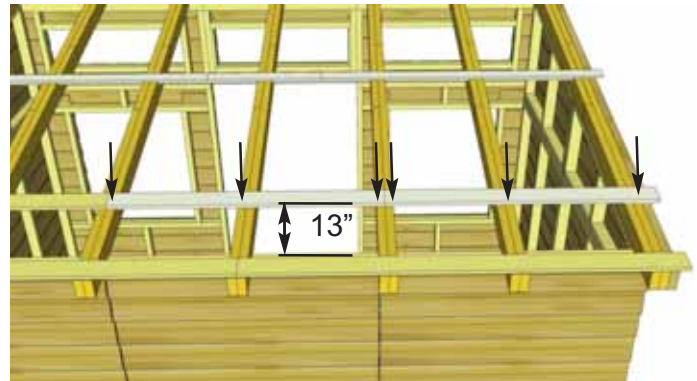
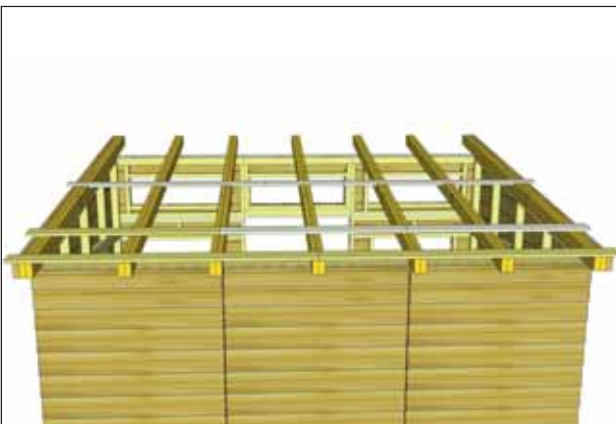

53. Locate two more **3H - Roof Batten Short** and line up as shown above. Maintain 13" between long and short Battens all the way across. Pre-drill pilot holes with 1/8" bit and secure each Short Batten to Rafters with **3 - 1 1/4" screws** each.

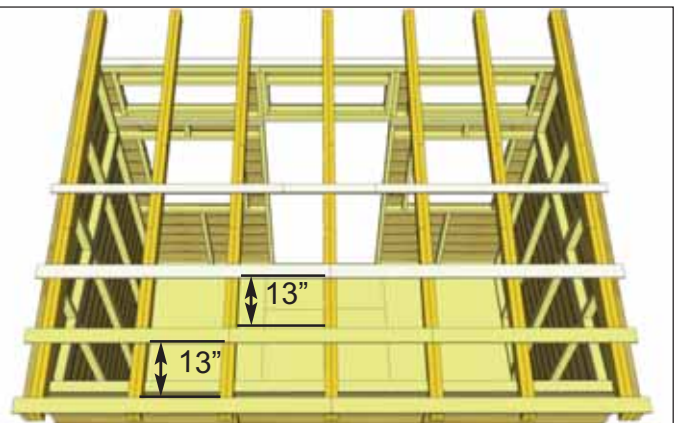
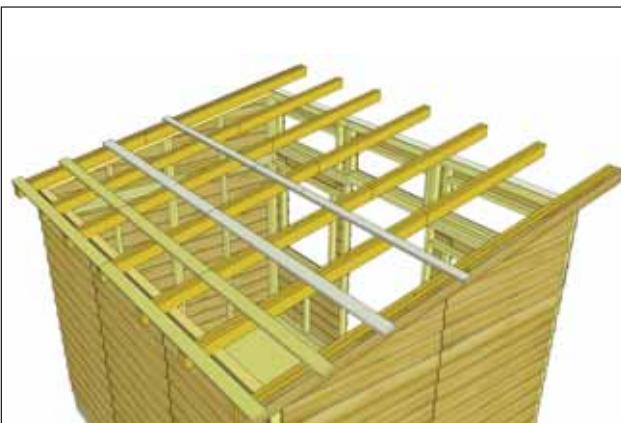

54. Third row of Battens will use **3G - Long Roof Battens**. Place Battens 13" up from second row of Battens. Follow attachment as per **Steps 50-51**.

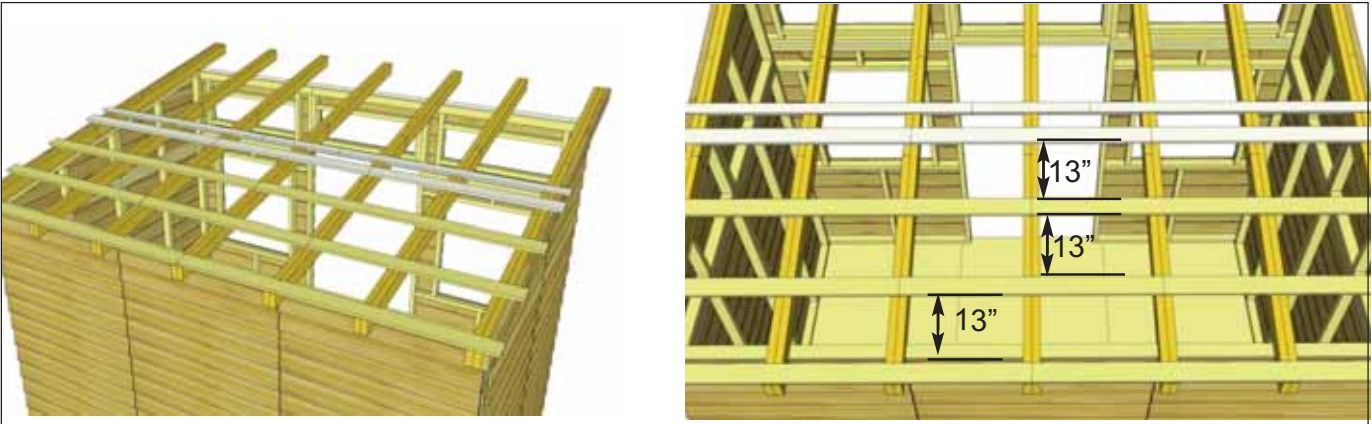

55. Fourth row of Battens uses **3H - Roof Batten Short**. Place and attach 13" up from third row of Battens as per **Steps 52-53**.

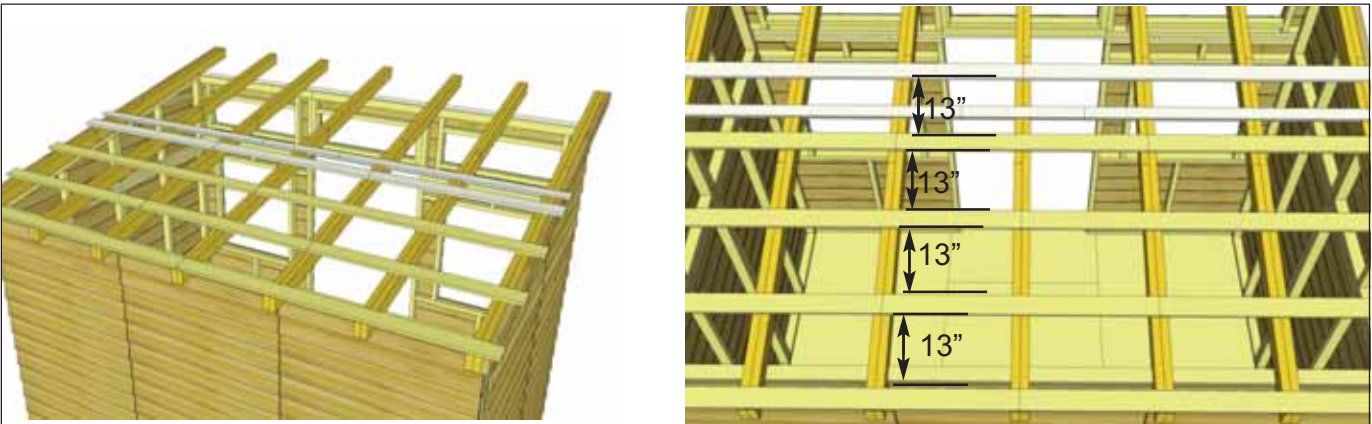

56. Fifth row of Battens uses **3G - Roof Batten Long**. Place and attach 13" up from fourth row of Battens as per **Steps 50-51**. Be sure to measure from fourth row of Battens and not from the rafter spacer.

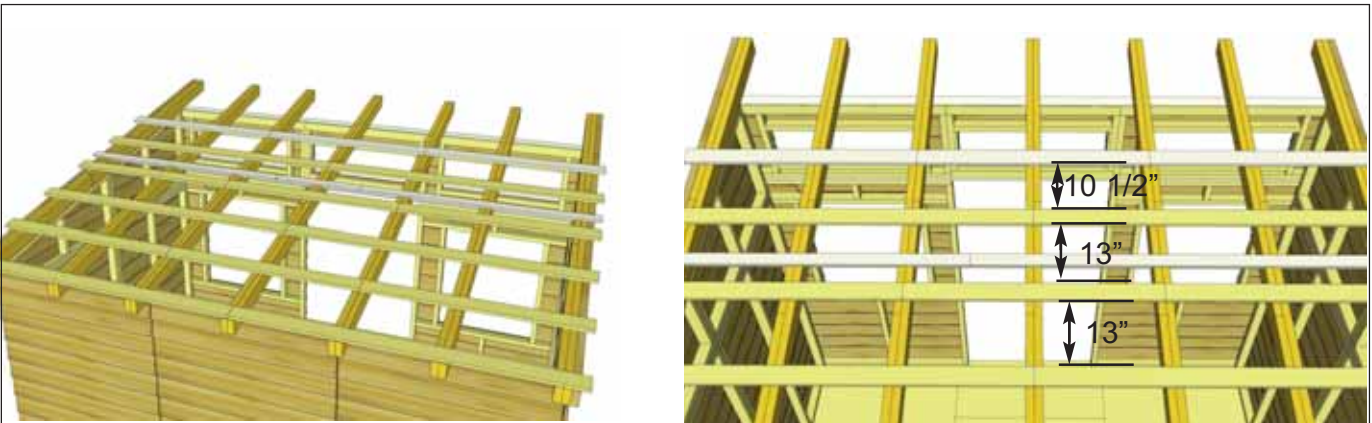

57. Sixth row of Battens uses **3H - Roof Batten Short**. Place and attach 10 1/2" up from fourth row of Battens as per **Steps 52-53**. Different Spacing is to accommodate overlap of Metal roof Panels in **Step 64**. Do not attach yet.

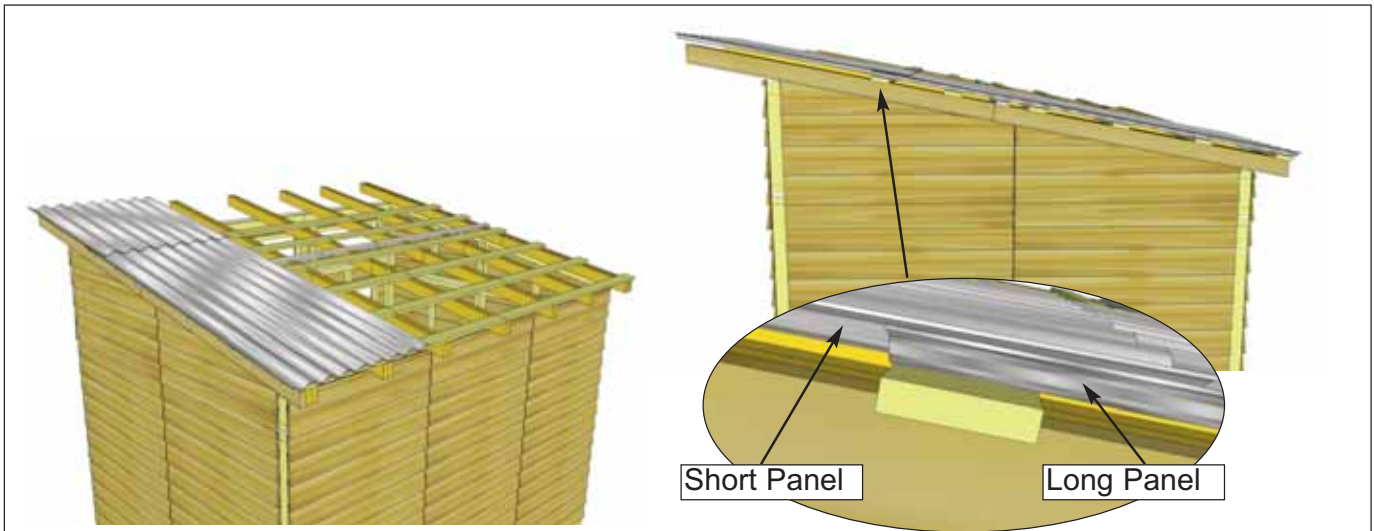

58. Before attaching sixth row of Battens grab one of each **3I - Metal Roof Panels Long** & **3J - Metal Roof Panels Short**. Lineup panels on roof as per **Steps 61 & 66** to ensure a proper fit. Short roof panel should overlap long roof panel on the sixth Batten as shown above. Once panels fit correctly remove and secure Battens.

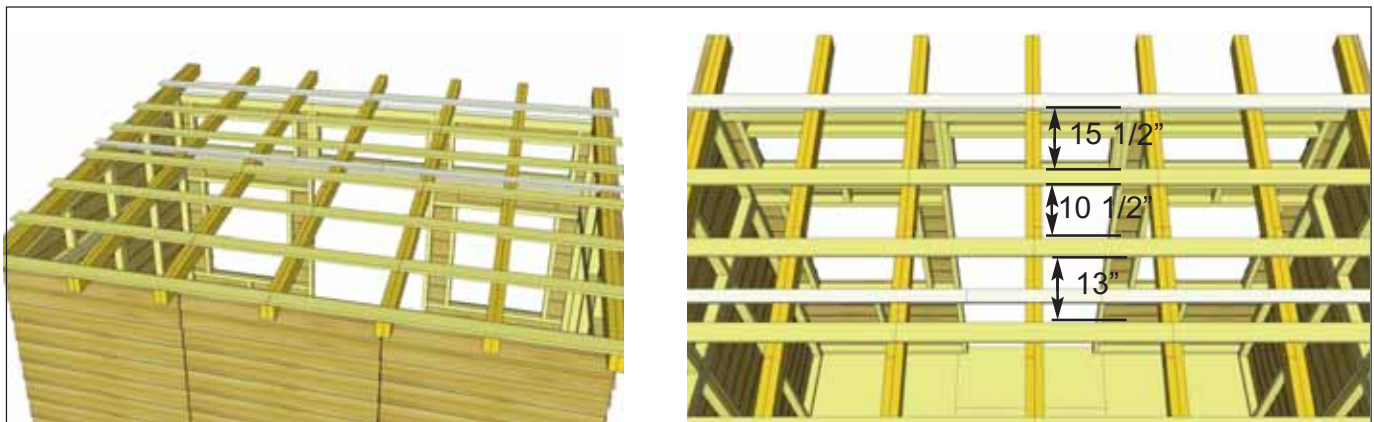

59. Seventh row of Battens uses **3G - Roof Batten Long**. Place and attach 15 1/2" up from fourth row of Battens as per **Steps 50-51**. Different Spacing is to accomodate overlap of Metal roof Panels in **Step 66**.

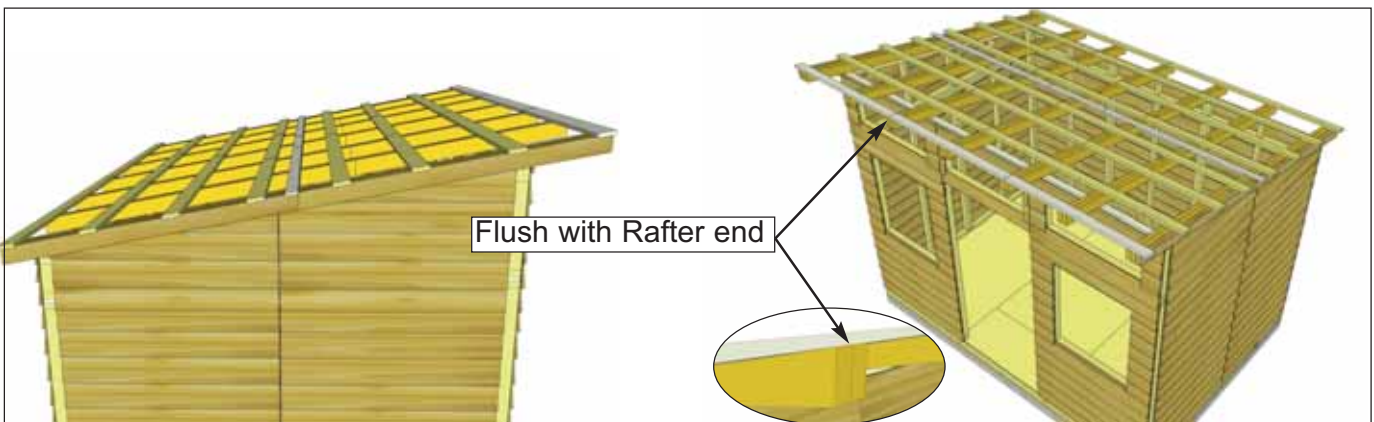

60. Eighth and last row of Battens uses **3H - Roof Batten Short**. Eighth row of Battens should be flush with edge of Rafters. Place and attach approximatley 13" up from seventh row of Battens as per **Steps 52-53**.

Completed view of Battens

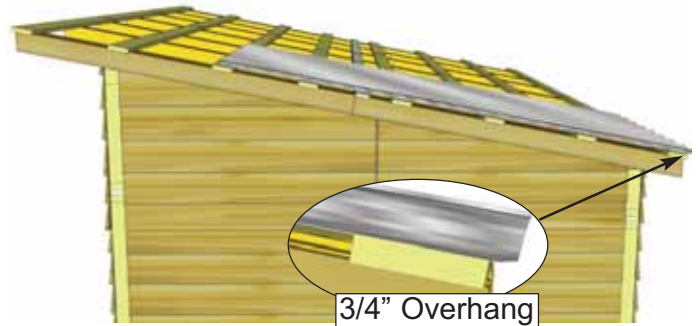
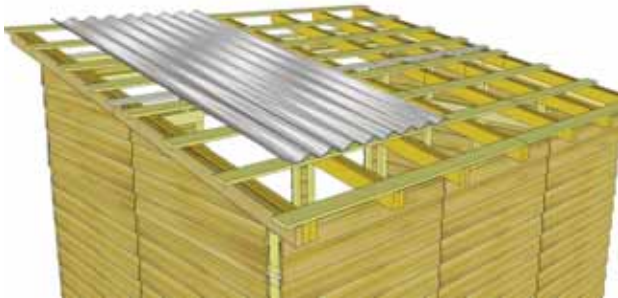
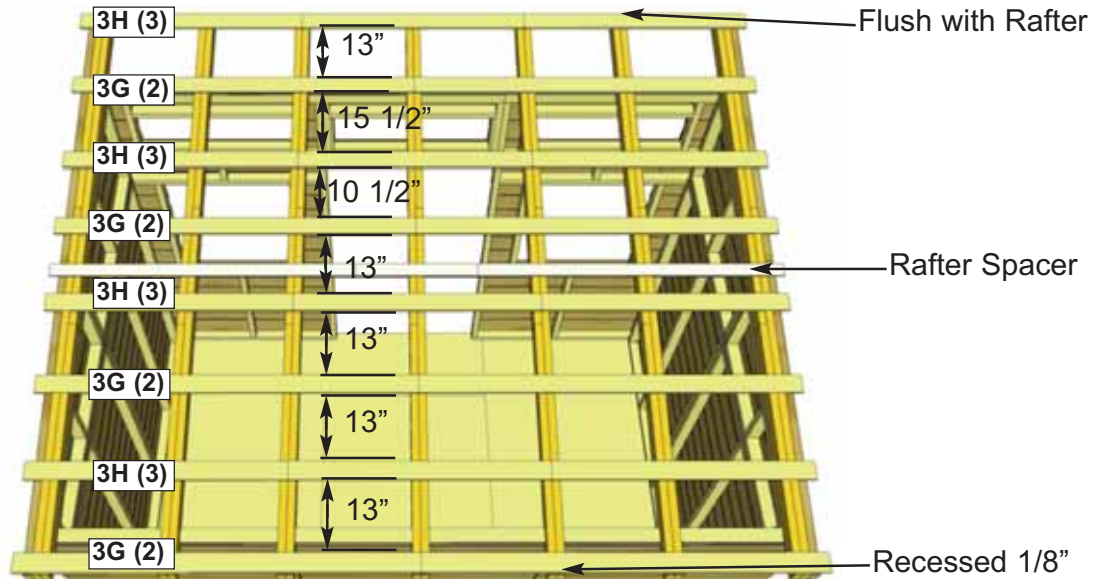

61. Locate **3I - Metal Roof Panels Long**. Start on the low side of the roof and place first Metal roof Panel on lower 6 Battens. Lineup so the sixth Batten is underneath Metal roof panel. Roof Panel should overhang Battens on low side of roof by 3/4". Do not attach Metal Roof Panels onto Battens until all panels are positioned and spaced. In the meantime, have a helper hold the panel in place so it doesn't slide off.

Parts (Steps 61 - 64)
3I - Metal Roof Panels (Long)
 (39" wide x 86" long) x 4
4AP - Foam Enclosures
 (Several Pcs)
 Hardware
30 - 1/4" x 2" Metal Screws

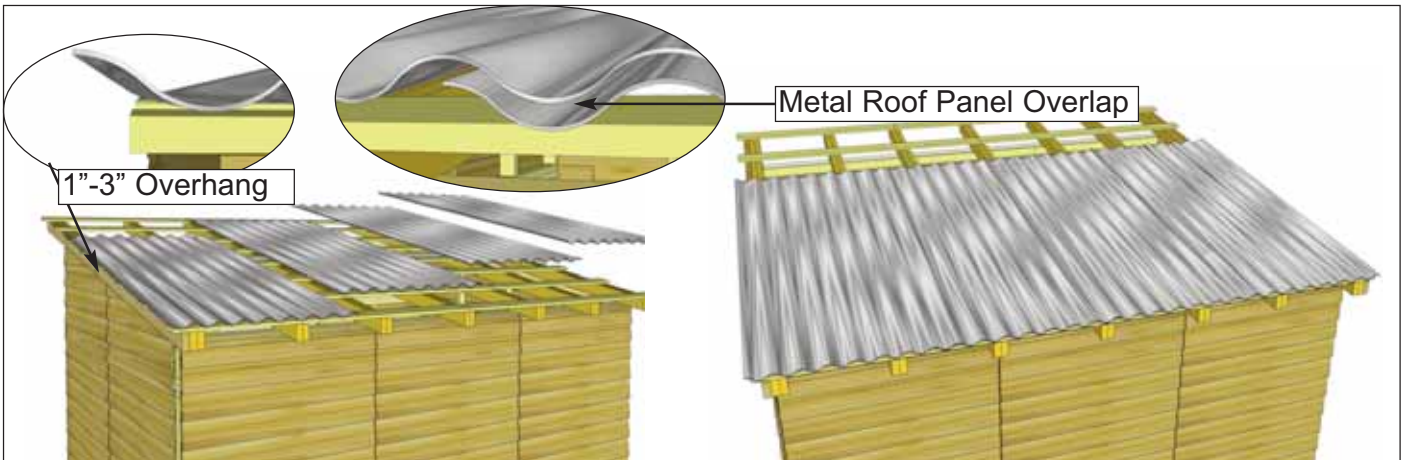

62. Locate remaining **3I - Metal Roof Panels Long** and position on Battens as per **Step 61**. Overlap Metal roof Panels to achieve the desired overall width. Overall width past the end of battens can vary from 1" - 3".

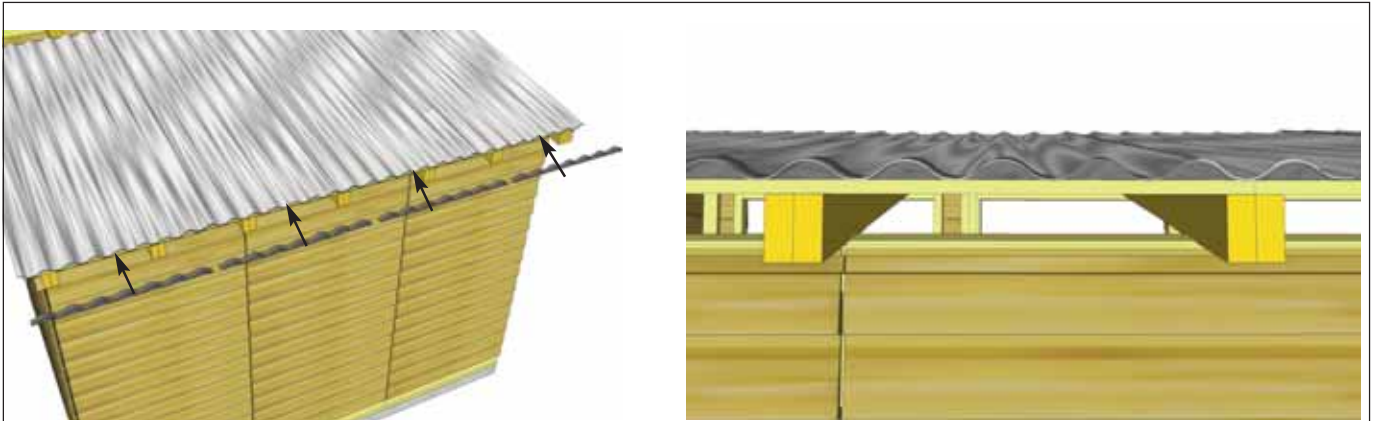

63. Before attaching Metal Roof Panels down, insert **4AP - Foam Enclosures** between Metal Roof Panels and Battens. Foam Enclosures will prevent moisture and unwanted bugs, etc from entering your shed from here.

64. Once Short Metal Roof Panels are spaced correctly from side-to-side- and top to bottom, lift panels up and run a bead of caulking down the overlapping seams of each panel to seal the joints.

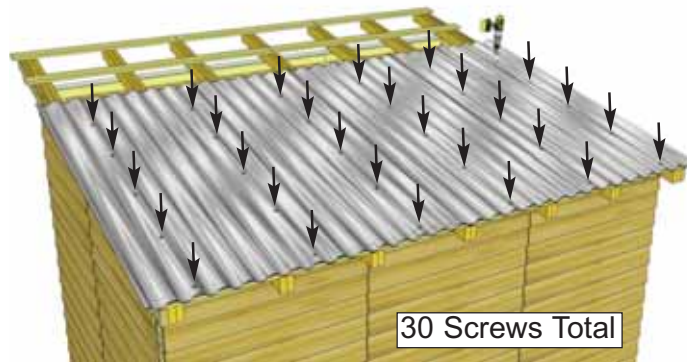
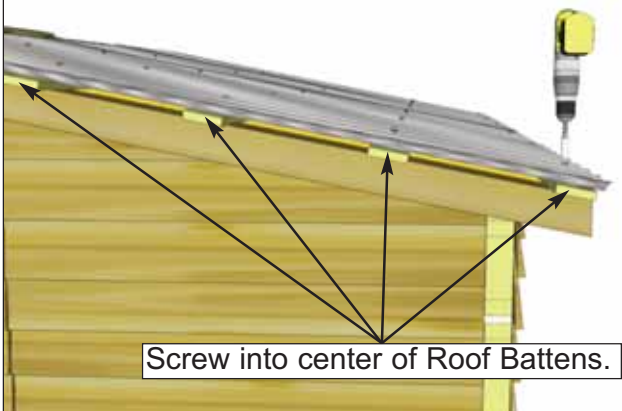
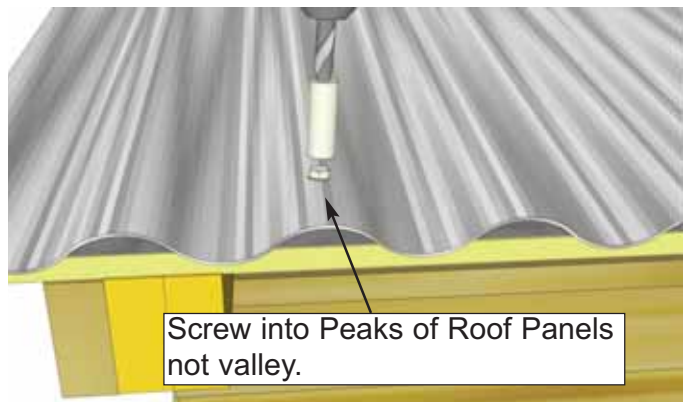
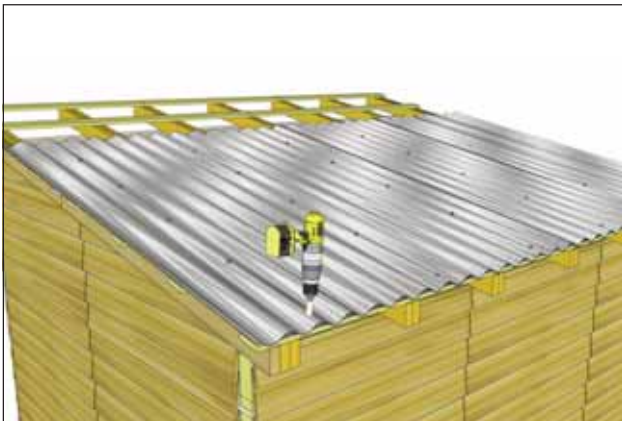
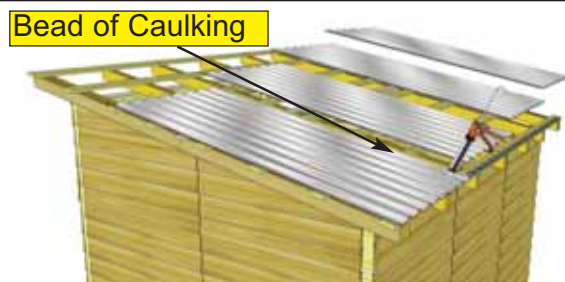

65. Using **30 - 1/4" x 2" Metal Screws** and 3/8" Nut Driver, secure Metal Roof Panels down to each Batten. Metal screw is self-tapping. Do not overtighten! Only attach into lower five rows of Battens. Screw into peaks of Roof Panels not the valleys. Screw into center of Battens.

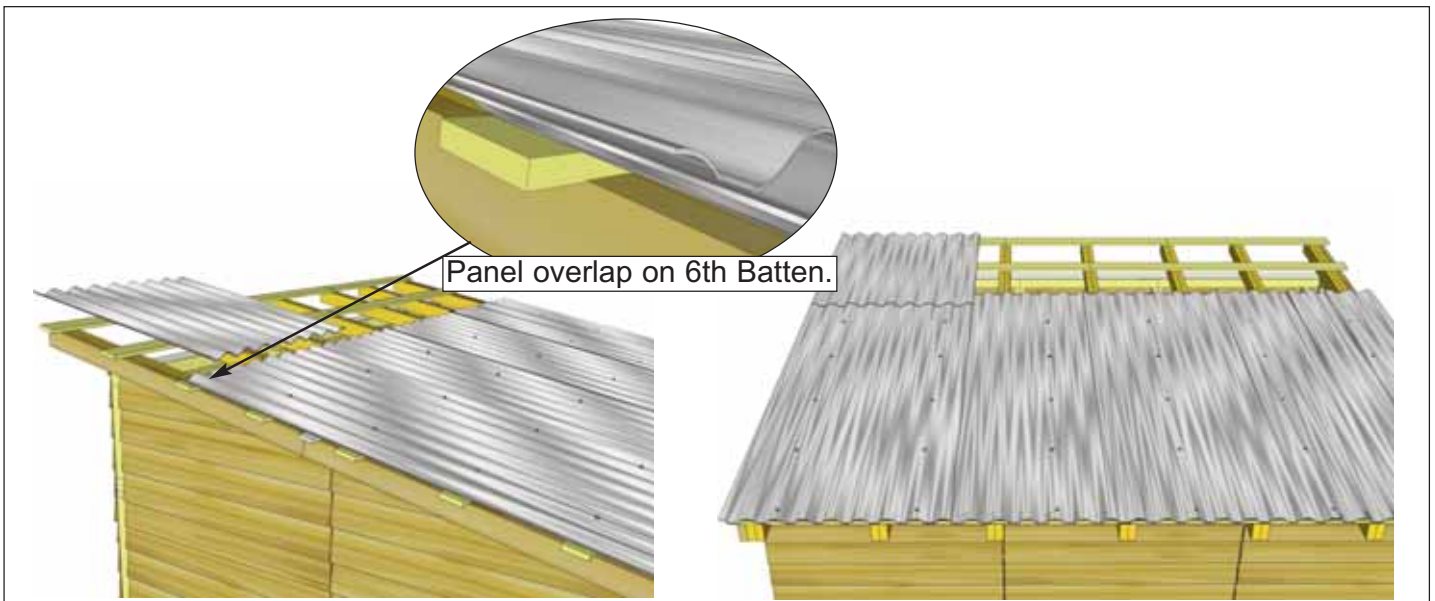

66. Locate **3J - Metal Roof Panels Short**. Place first short roof panel onto Battens and lineup with same overhang as the long roof panels. Roof Panels should overlap on sixth Batten with short panels on top. Panel will overhang door side Batten by approximately 1". Do not attach Metal Roof Panel until all panels are positioned and spaced. In the meantime, have a helper hold the panel in place so it doesn't slide off.

- Parts (Steps 66 - 69)
3J - Metal Roof Panels (Short)
 (39" wide x 41" long) x 4
4AP - Foam Enclosures
 (Several Pcs)
Hardware
12 - 1/4" x 2" Metal Screws

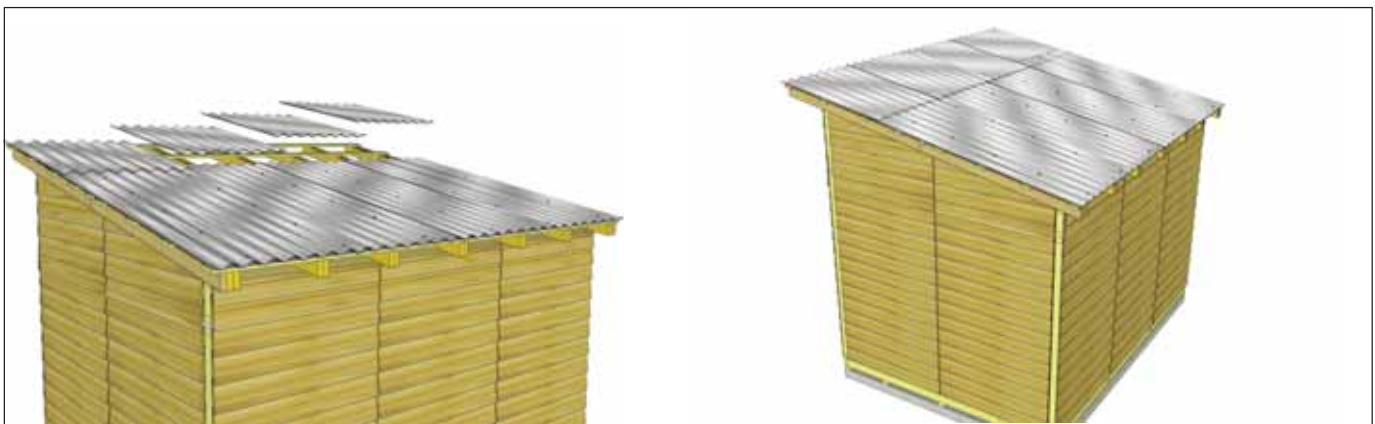

67. Locate and position remaining **3J - Metal roof Panels Short** on Battens as per Step 64. Space panels so width matches long roof panels.

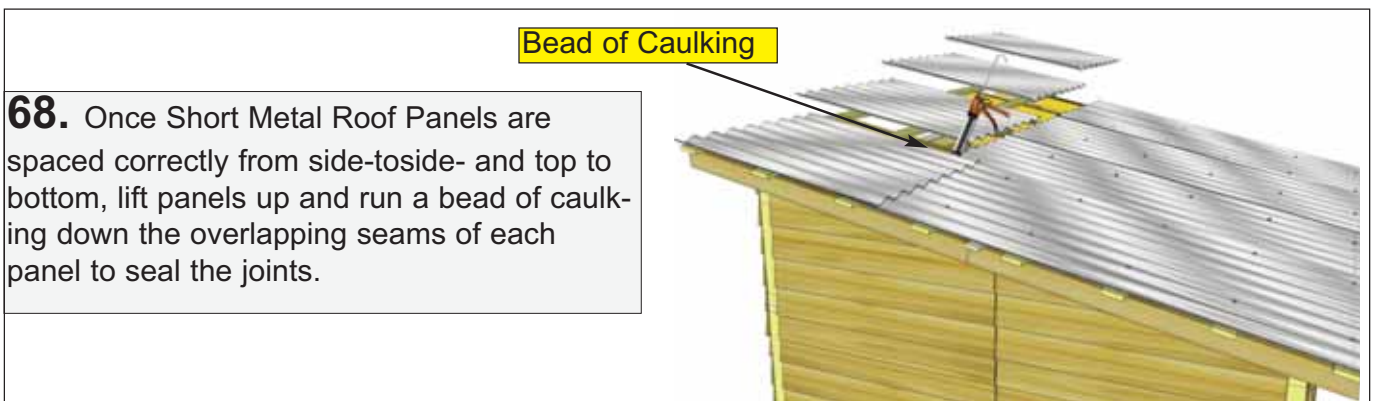

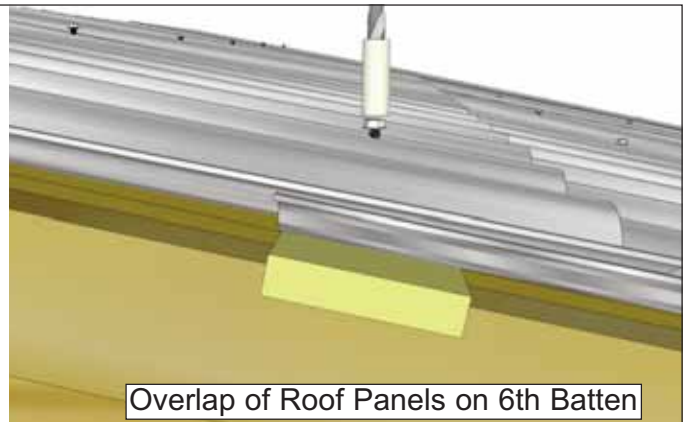
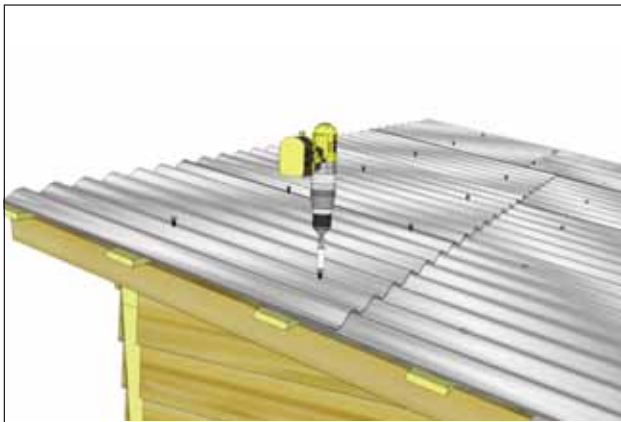

Overlap of Roof Panels on 6th Batten

69. Using 12 - 1/4" x 2" Metal Roof Screws and 3/8" Nut Driver, secure Metal Roof Panels down to next two Battens. Final Batten will be used to secure Drip Cap in **Step 84**. Metal screw is self-tapping. Do not overtighten! Screw into peaks of Roof Panels not the valleys. Screw into center of Battens. Where panels overlap ensure to screw through both panels into Batten.

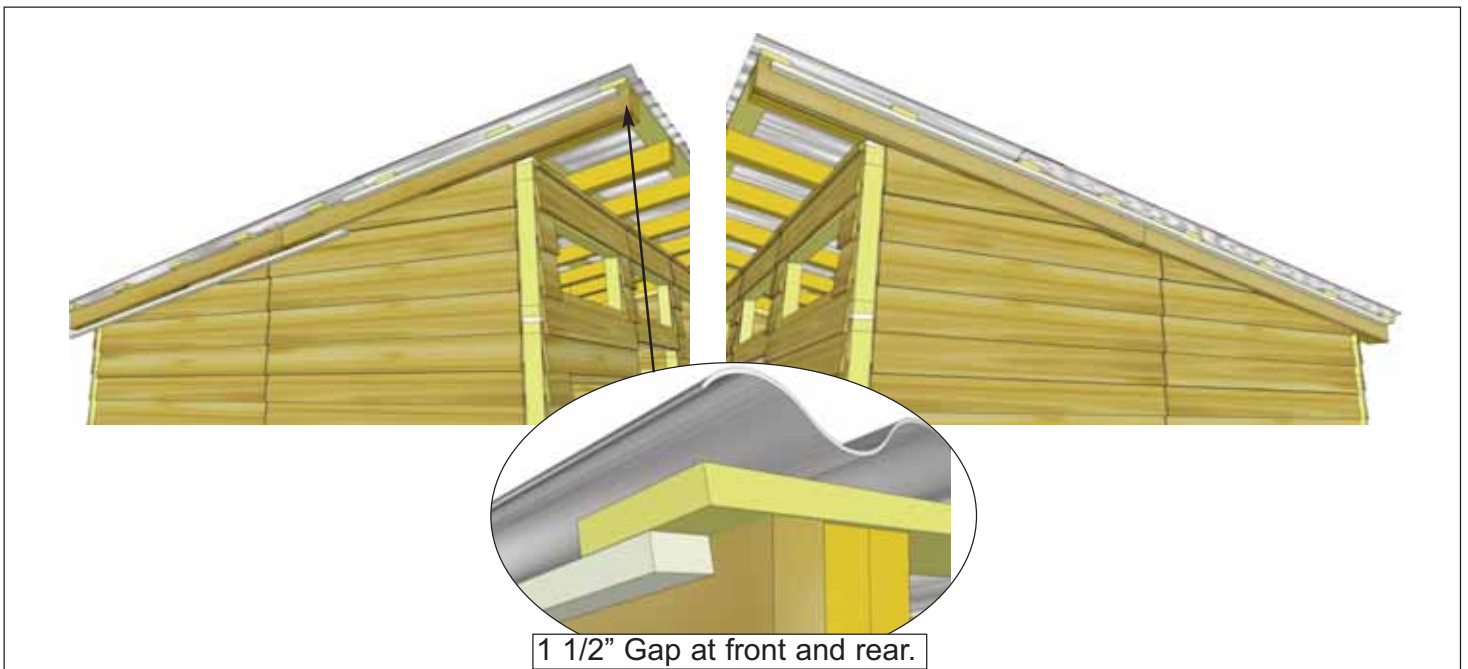

1 1/2" Gap at front and rear.

70. Locate **3M & 3N - Roof/Facia Nailing Strips**. Strips will attach to the underside of Battens, flush with edge as shown above. Strips provides for a greater nailing surface later when you attach side facia. Attach both pieces with **7 - 1 1/4" Screws** total leaving a 1 1/2" gap at front and rear. Evenly space screws. Attach remaining cleats to panels to opposite side.

<u>Parts</u>
3M - Roof/Facia Nailing Strips (3/4" x 1 1/2" x 72") x 2
3N - Roof/Facia Nailing Strips (3/4" x 1 1/2" x 44") x 2
<u>Hardware</u>
(S2 - 1 1/4" Screws) x 14 total

4. Trim & Miscellaneous Section

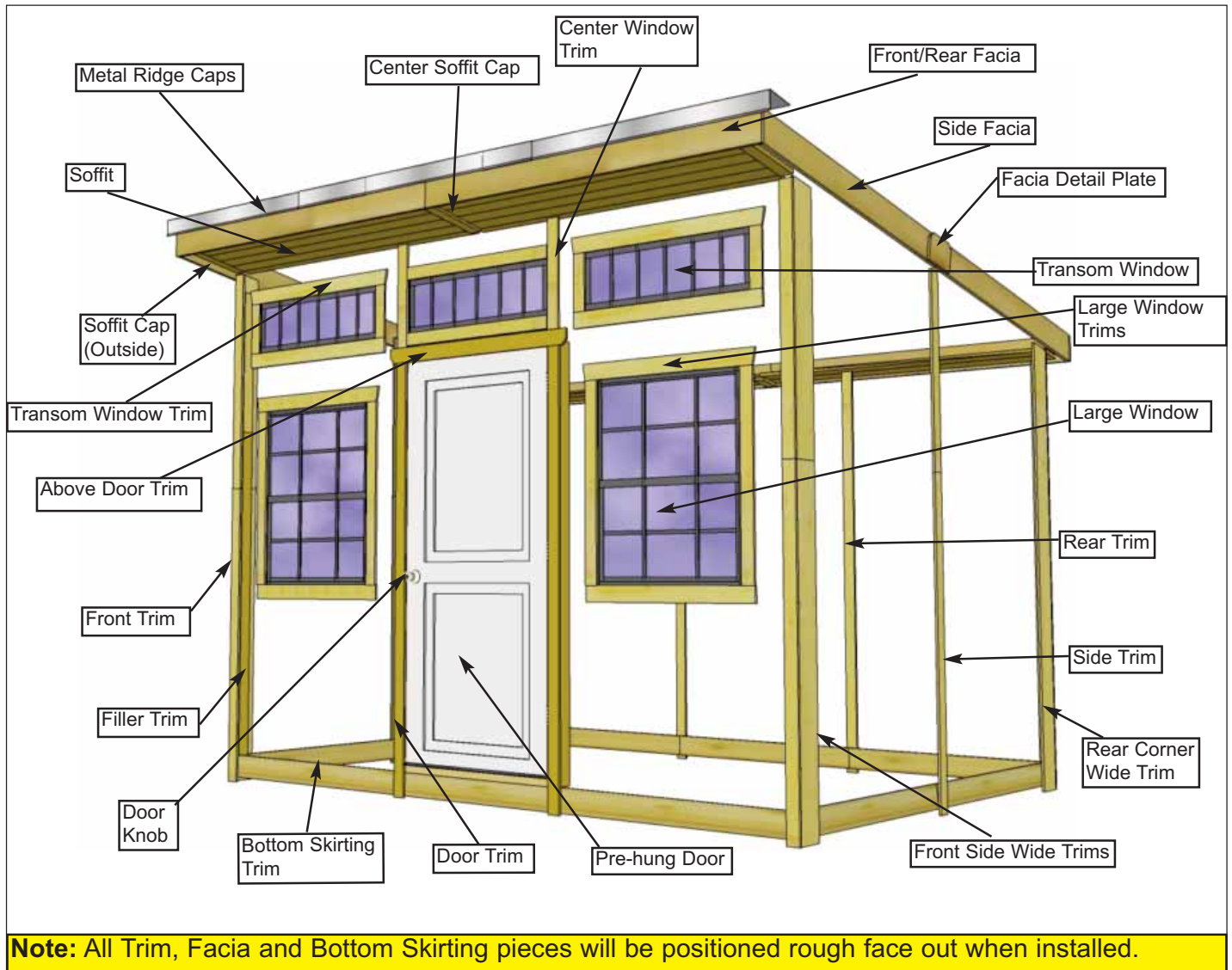

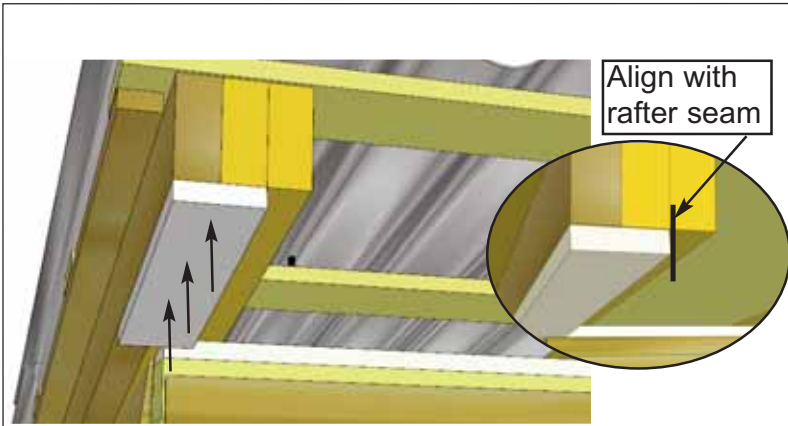

71. Locate **4A - Front Soffit Caps** and position underneath rafter. Align edge with rafter seam and tight against wall. Cap should not extend past end of rafters. Attach with **3 - 1 1/2" Finishing Nails**. Complete opposite side cap now.

<u>Parts</u>
4A - Left/Right Outside Front Soffit Cap (3/4" x 3" x 14") x 2
<u>Hardware</u>
(N1 - 1 1/2" Finishing Nails) x 6 total

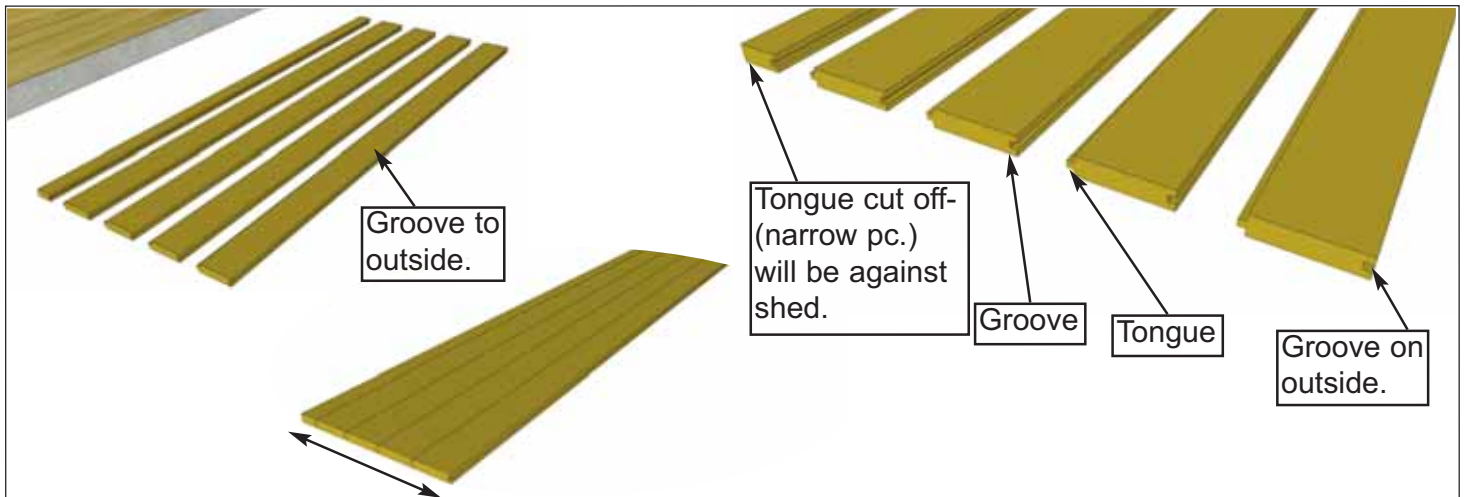

72. Locate **4B - Front Soffits** (Tongue & Groove) & **4C - Front Soffits** (with Tongues cut off). Start by fitting 5 pieces together (4 wide and 1 narrow) as shown above. Next assemble other 5 pieces the same way.

<u>Parts</u>
4B - Front Soffits (3/4" x 3 1/2" x 67") x 8
4C - Front Soffits (3/4" x 2 1/4" x 67") x 2

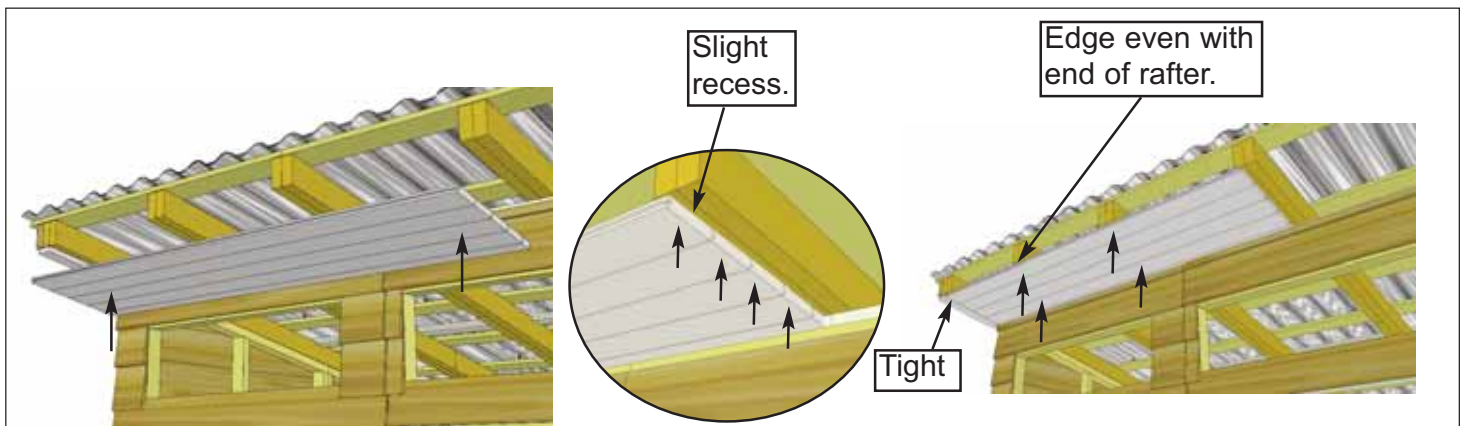

73. Carefully lift one of the front soffit sections and position underneath rafters tight against soffit cap. Front edge of soffit (grooved edge) should not extend past end of rafters. Attach with **12 - 1 1/2" Finishing Nails**.

<u>Hardware</u>
N1 - 1 1/2" Finishing Nails x 12 total

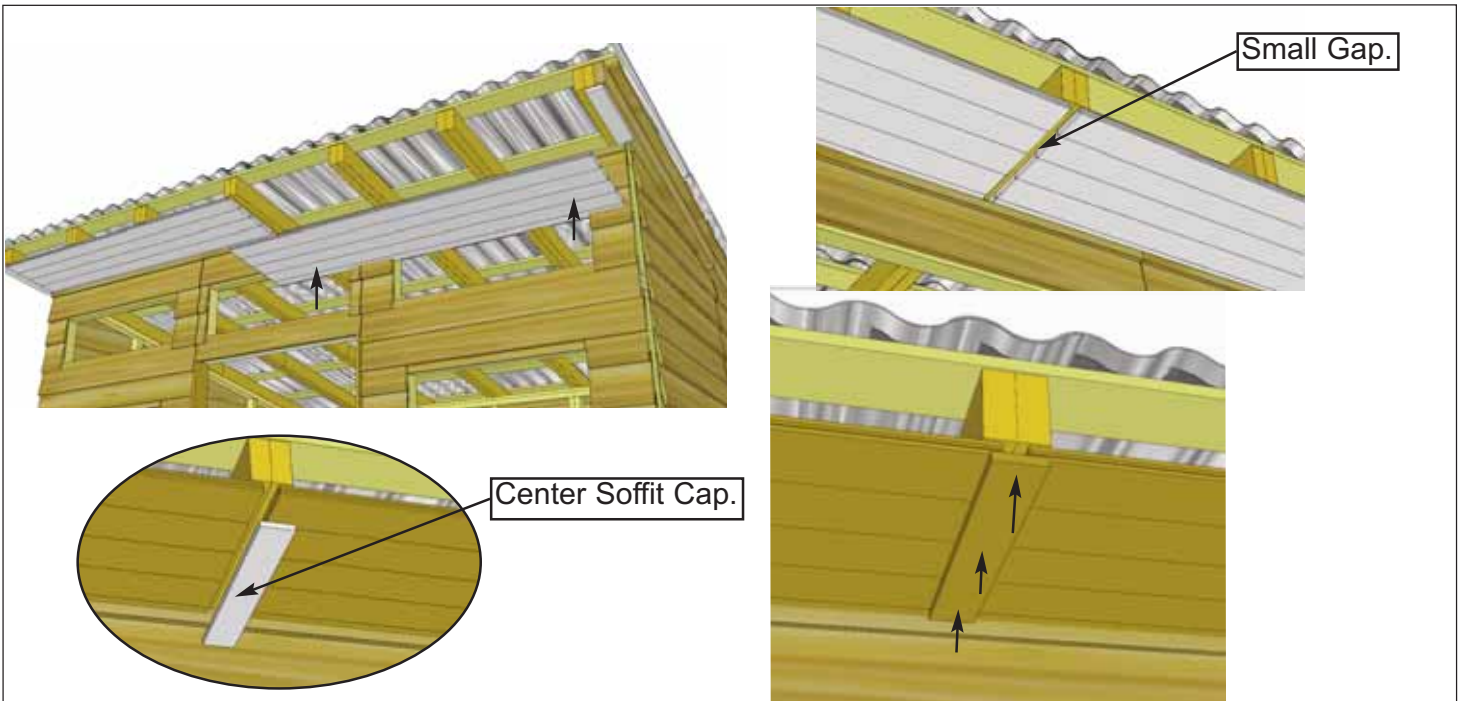

74. Carefully lift, position and attach second soffit section underneath rafters tight against soffit cap as per **Step 73**. Attach with **12 - 1 1/2" Finishing Nails**. Position **4D - Front Soffit Center Cap** underneath rafters and over gap where front soffits meet. Attach center cap with **3 - 1 1/2" Finishing Nails**.

<u>Parts</u>
4D - Front Soffit Center Cap (1/2" x 2 1/2" x 13 3/4") x 1
<u>Hardware</u>
N1 - 1 1/2" Finishing Nails x 15 total

75. Locate and position **4E - Rear Soffit Caps** underneath rear rafter, tight against wall and aligned with rafter seam as per **Step 71**. Cap should not extend past end of rafters. Attach with **2 - 1 1/2" Finishing Nails**. Complete opposite side cap now.

Locate **4F - Rear Soffits (Tongue & Groove)** & **4G - Rear Soffits (with tongues cut off)**.

Start by fitting 2 pieces together (1 wide and 1 narrow) as shown to the right. Assemble other 2 pieces the same way.

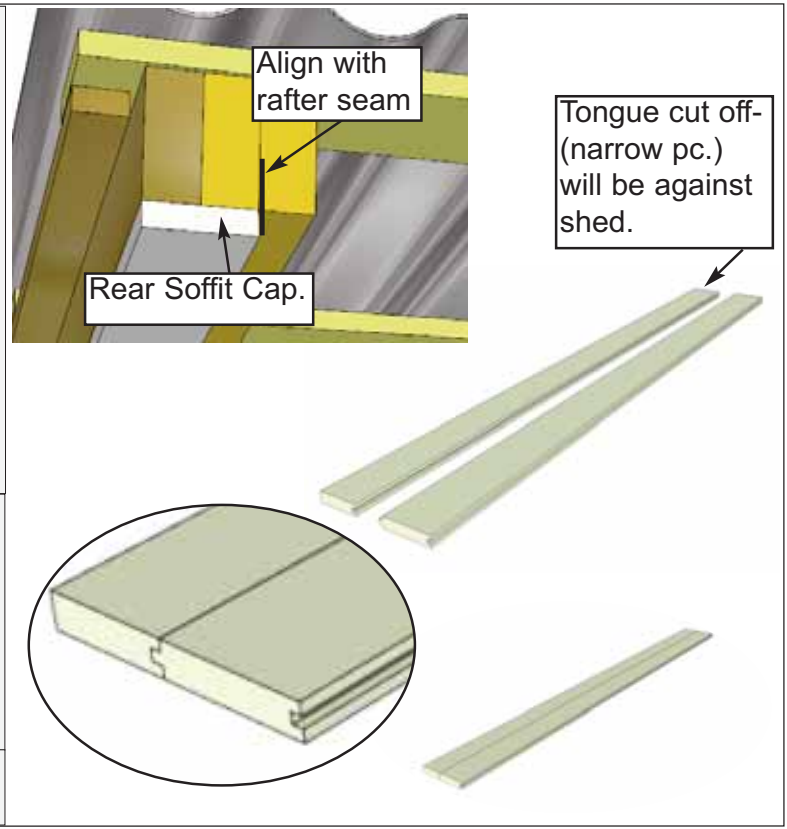

<u>Parts</u>
4E - Left/Right Outside Rear Soffit Caps (3/4" x 3" x 6 1/2") x 2
4F - Rear Soffits (3/4" x 3 1/2" x 67") x 2
4G - Rear Soffits (3/4" x 3" x 67") x 2
<u>Hardware</u>
(N1 - 1 1/2" Finishing Nails) x 4 total

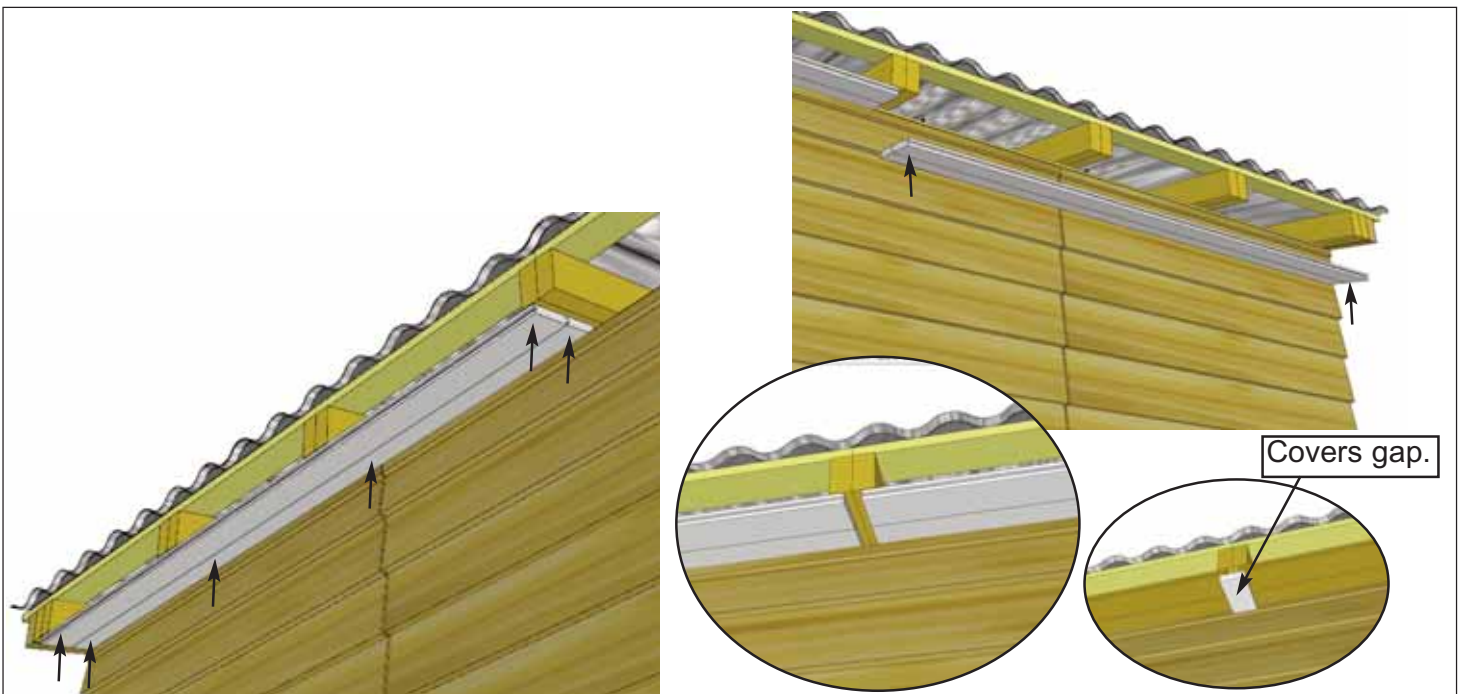

76. Carefully lift one of the rear soffit sections and position underneath rafters tight against soffit cap. Front edge of soffit (grooved edge) should not extend past end of rafters. Attach with **6 - 1 1/2" Finishing Nails** per section. Position and attach remaining rear soffit pieces as per **Step 74**. Position **4H - Rear Center Soffit Cap** underneath rafters and over gap where rear soffits meet. Attach center cap with **2 - 1 1/2" Finishing Nails**.

<u>Parts</u>
4H - Rear Center Soffit Cap (1/2" x 3 1/2" x 5 1/4") x 1
<u>Hardware</u>
N1 - 1 1/2" Finishing Nails x 14 total

77. Position and attach **4I, 4J & 4K - Top Horizontal Wall Trims**. Top trims are pieces of wall siding that are ripped to 1" wide pieces. They fit against the soffit and wall and finish trimming the shed. Use **3 - 1 1/2" Finishing Nails** to secure each trim.

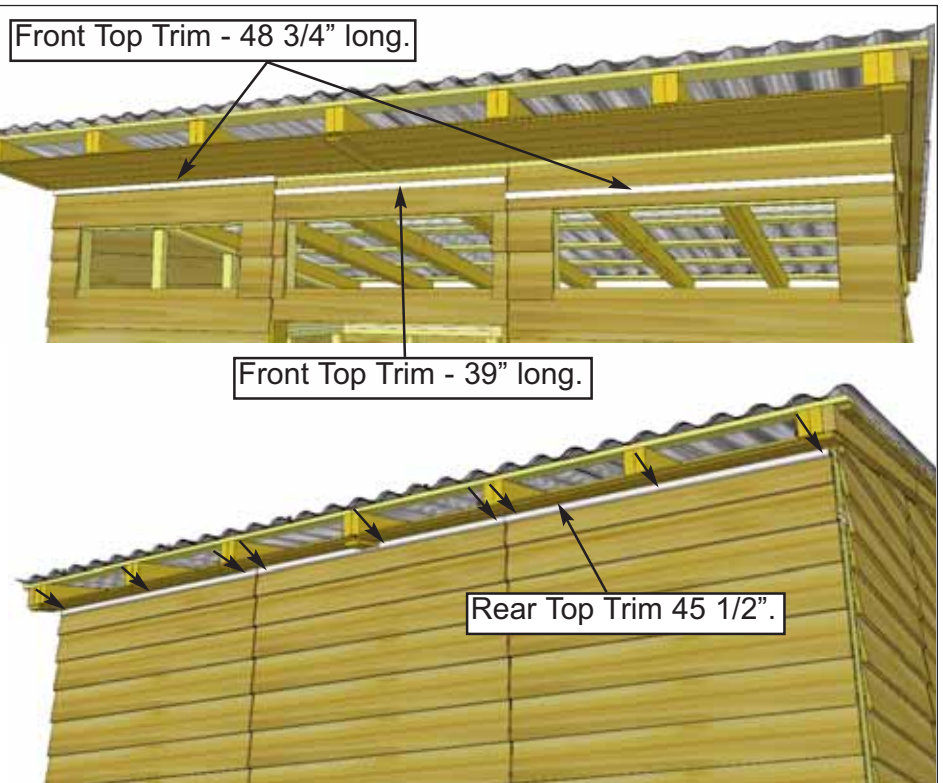

<u>Parts</u>
4I - Front Top Horizontal Wall Trim (1/2" x 1" x 39") x 1
4J - Front Top Horizontal Wall Trim (1/2" x 1" x 48 3/4") x 2
4K - Rear Top Horizontal Wall Trim (1/2" x 1" x 45 1/2") x 3

<u>Hardware</u>
N1 - 1 1/2" Finishing Nails x 18 total

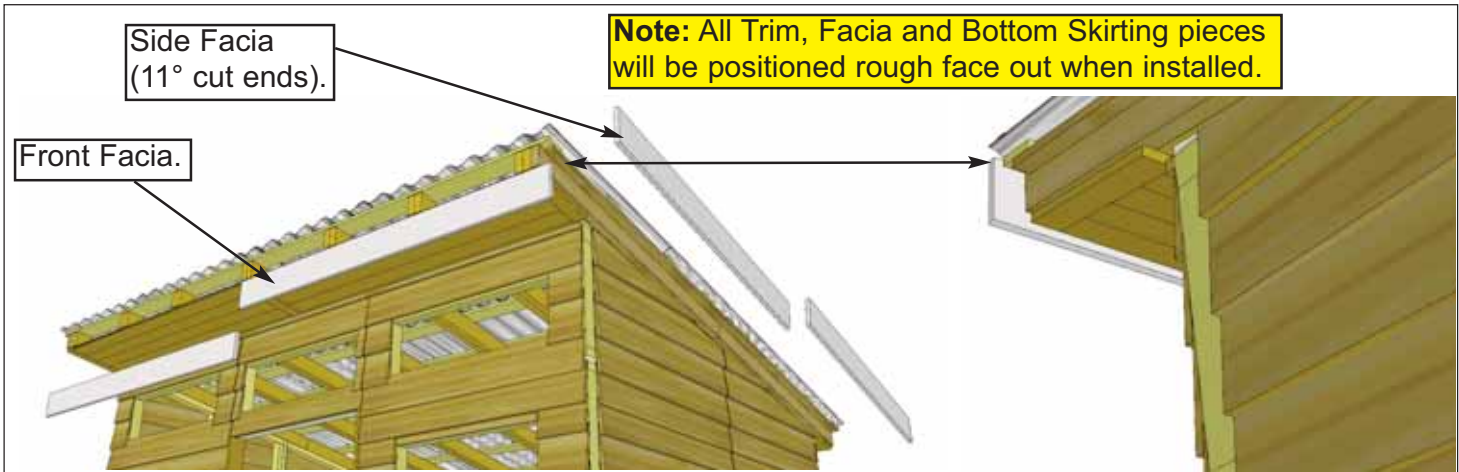

78. Locate **4L - Front/Rear Facia** & **4M - Side Facia**. Start by positioning one front facia up against front end of rafters.

Parts (Steps 78 - 82)
4L - Front/Rear Facia
 (3/4" x 5 1/2" x 72 3/4") x 4
4M - Side Facia - 11° cut ends (mirrored)
 (3/4" x 5 1/2" x 60") x 4

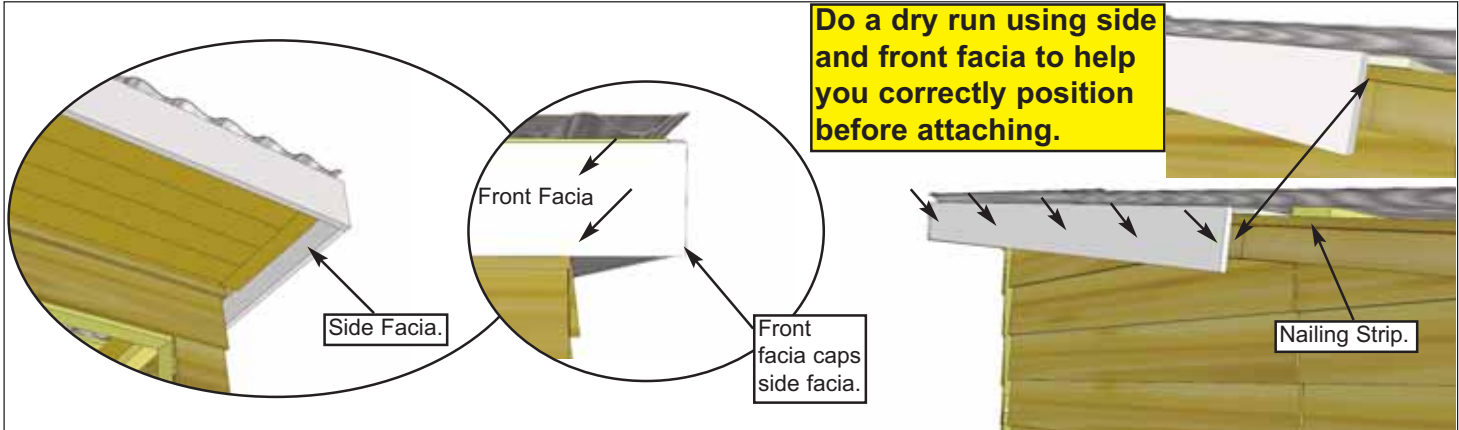

79. Next, have your helper place an angle cut Side Facia Board up tight under metal roof and flush against nailing strip. Line front facia up so it caps the side facia. With front facia correctly aligned, attach front facia to rafter ends with **8 - 1 1/2" Finishing Nails**. Attach side facia to edge of nailing strip and batten ends with **5 - 1 1/2" Finishing Nails**.

Hardware (Steps 79 - 82)
N1 - 1 1/2" Finishing Nails
 x 52 total

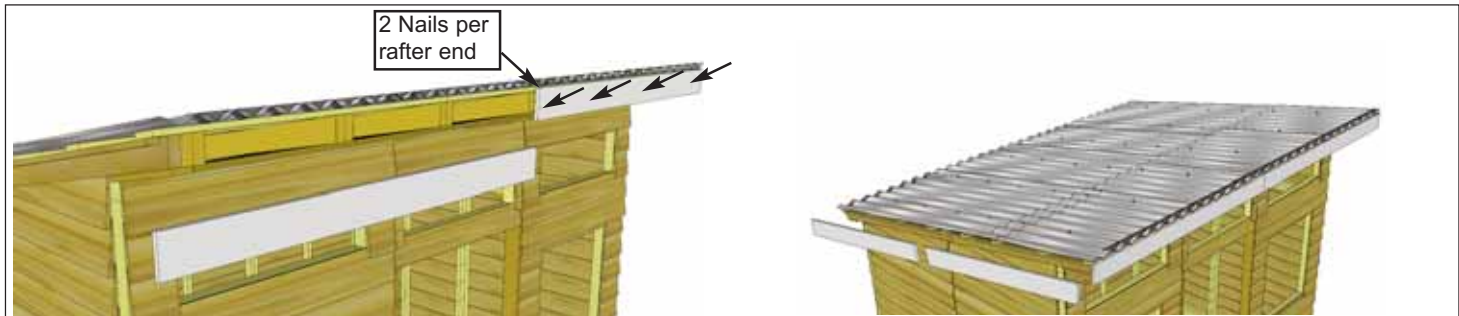

80. Align and attach remaining front facia as per **Step 79**. Align next two side facias on opposite side as first side facia. Once again, do a dry run before attaching. There will be a Facia Detail Plate attached in **Step 85** to hide any gaps where facia pieces meet in the middle.

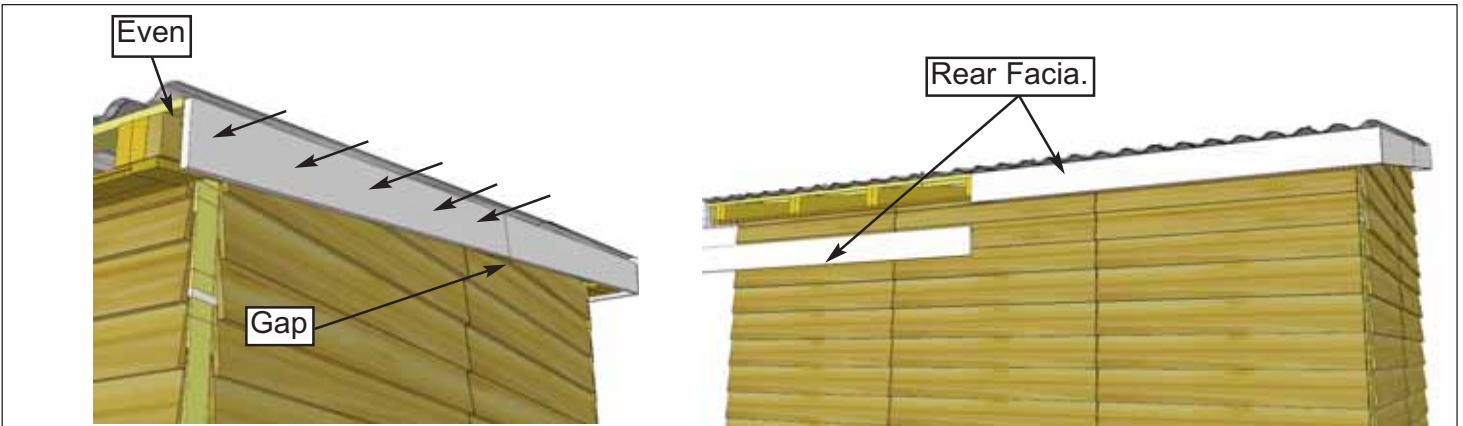

81. After aligning two side facias and first rear fascia, attach as per **Steps 78-80**. Once again, do a dry run before attaching.

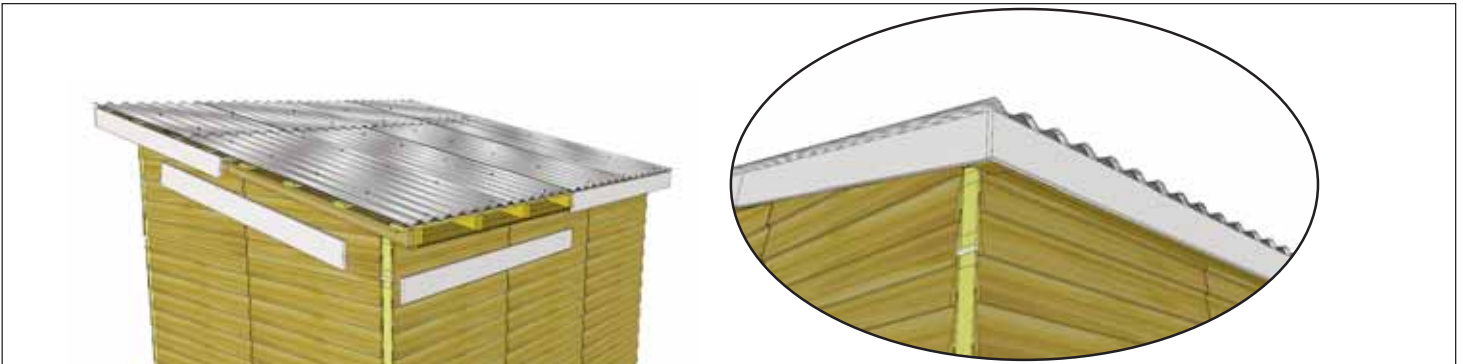

82. Attach remaining rear and lower side fascia as per **Steps 78-81**.

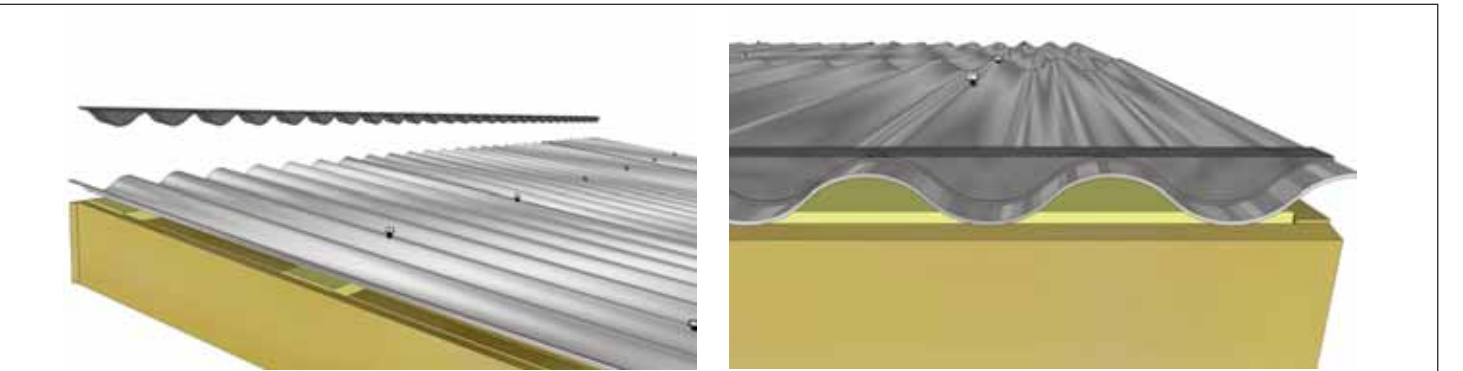

83. Locate remaining **4AP - Foam Enclosures for Metal Roof**. Before attaching Metal Ridge Caps, place strips of Foam Enclosures near to top. Foam Enclosures will prevent moisture, unwanted insects, etc.. from entering your shed.

Parts
4AP - Foam Enclosures
 (Several Pcs)

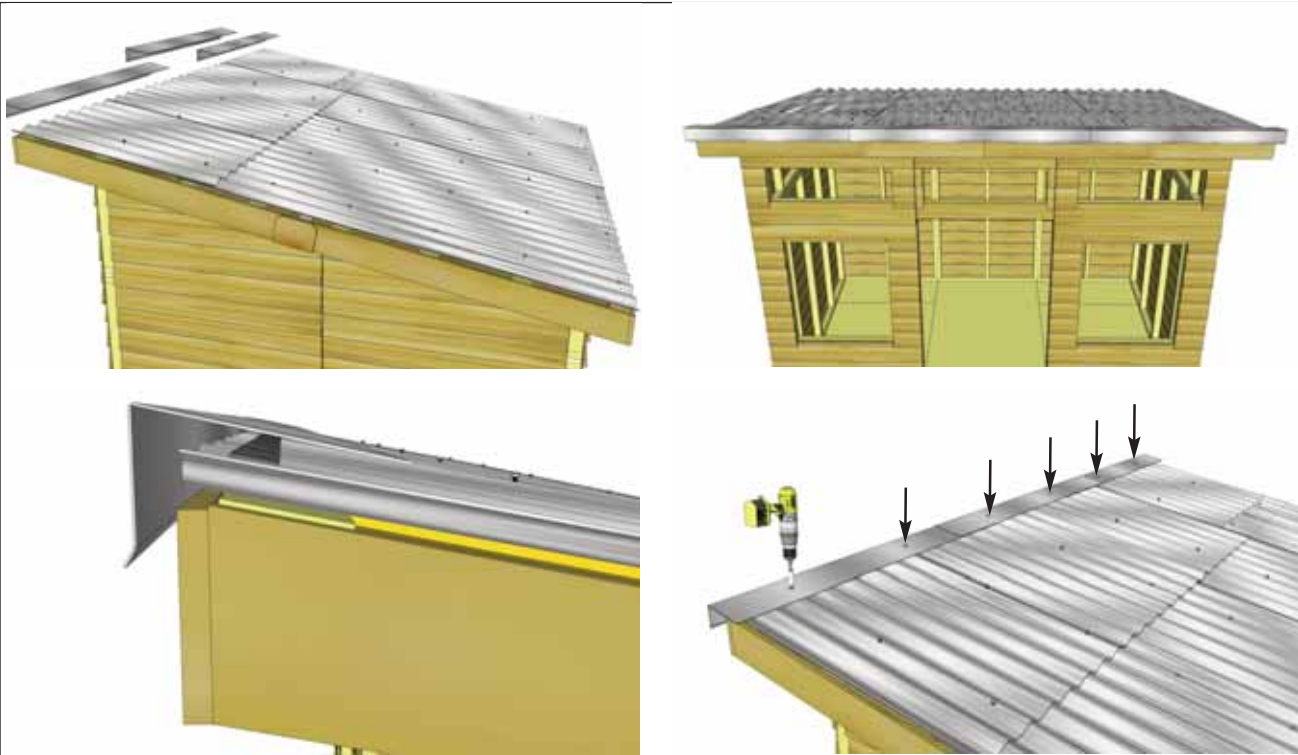

84. Locate **3K - Metal Drip Caps** and place on high side of metal roof. Evenly space from side-to-side allowing caps to overlap each other. Overhang the cap approximately 1" past each end. Secure with **6 - 5/26" x 7/8" metal drip cap screws**, screwing into final roof Batten

<u>Parts</u>
3K - Metal Drip Caps (60" long angled) x 3
<u>Hardware</u>
(1/4" x 2" Metal Roof Screws) x 6

Facia Detail plates on side and rear

85. Attach **4N - Facia Detail Plates** to cover seam where fascia's meet on side and rear. Secure each plate with **4 - 1 1/2" Finishing Nails**.
Nails.

Parts

4N - Facia Detail Plates
(1/2" x 7 1/2" x 5 1/2") x 3

Hardware

N1 - 1 1/2" Finishing Nails
x 16 total



86. Attach **40 - Bottom Skirting** around base of the shed. Skirting will hide floor framing. The side skirting pieces will meet together in the center. Gaps on outside will be covered by wide trim pieces later. Start with side skirting pieces first and attach each with **4 - 1 1/2" Finishing Nails**.

<p><u>Parts (Steps 86 - 88)</u> 40 - Side/Rear Bottom Skirting (1/2" x 4 1/2" x 45 1/2") x 7</p>
<p><u>Hardware (Steps 86 - 88)</u> N1 - 1 1/2" Finishing Nails x 28 total</p>



87. Complete rear and side skirting attachments as per **Step 86**.

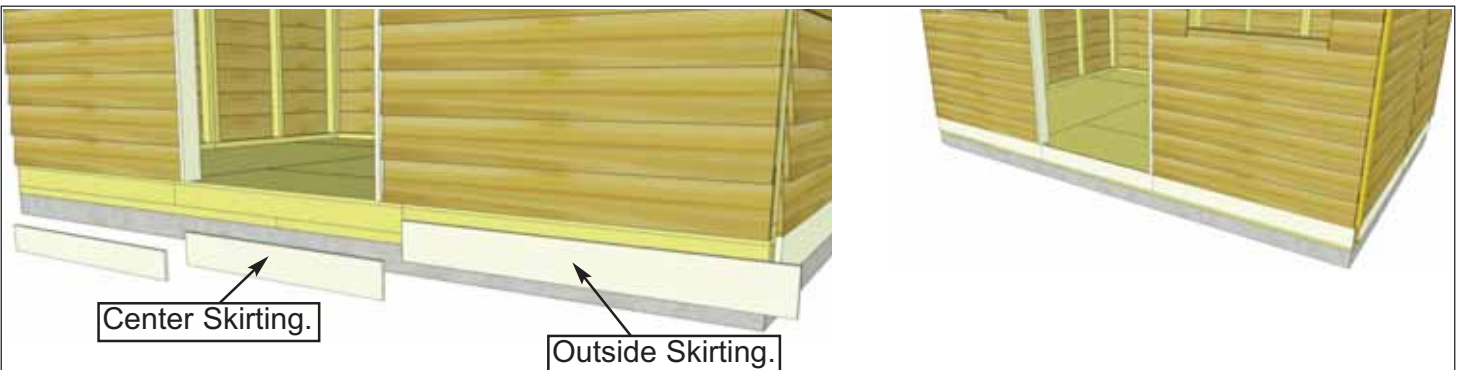

88. Attach **4P & 4Q - Front Bottom Skirting** as per **Step 86**.

<p><u>Parts</u> 4P - Center Front Bottom Skirting (1/2" x 4 1/2" x 39") x 1 4Q - Outside Front Bottom Skirting (1/2" x 4 1/2" x 48 3/4") x 2</p>
--

<p><u>Hardware</u> N1 - 1 1/2" Finishing Nails x 12 total</p>
--

Reminder: Orientation of Trim Pieces is important. Left/Right pieces are mirror images with rough side facing outward

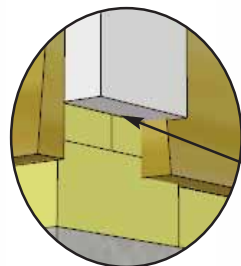

Filler Trims will get covered in **Steps 90-92** with proper corner trim.

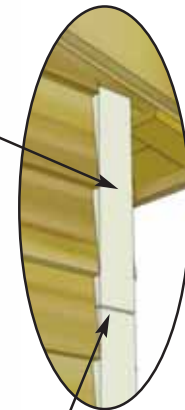

Small gap between trims.

89. Position **4R - Filler Trim** (they serve as nailing strips) in corner of side wall, aligned flush with top of bottom skirting. Attach with **4 - 1 1/4" Screws** and repeat for all 4 corners. Next, attach **4S & 4T - Front/Rear Top Filler Trim** with **2 - 1 1/4" Screws** per piece.

Parts
4R - Filler Trim
 (3/4" x 2 1/2" x 72") x 4
4S - Front Top Filler Trim
 (3/4" x 2 1/2" x 28 1/2") x 2
4T - Rear Top Filler Trim
 (3/4" x 2 1/2" x 12") x 2

Hardware
S2 - 1 1/4" Screws
 x 22 total

Top Front Wide (22° scarf bottom / 11° cut top)

Top Front (narrow) (22° scarf bottom)

11° cut top.

Outside Soffit Cap.



Rear Side Wide (11° cut top)

Rear Corner (narrow)

Bottom Front Wide (22° scarf top)

Bottom Front (narrow) (22° scarf top)

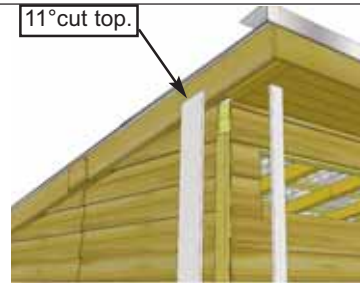

Shipping package length restrictions requires front/side trim to be cut down in length, scarf jointed and then attached on assembly.

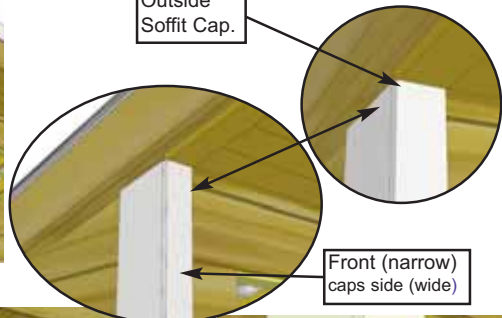

Front (narrow) caps side (wide)



Scarf joint cuts on bottoms.

90. There are 2 front corner trim packages (Left/Right) with 4 pieces per package which are needed to complete each corner. Start with the left side corner trim package by placing **4U - Top Front Narrow Corner Trim** tight underneath soffit cap and **4V - Top Front Side Wide Corner Trim** tight underneath rafter fascia so it is capped by the narrow trim. When correctly aligned, attach each trim with **6 - 1 1/2" Finishing Nails**. Have helper assist by holding trim.

Parts (Steps 90 - 91)
4U - Top Front Narrow Corner Trim
 with 22° scarf cut bottom
 (1/2" x 2 1/2" x 46") x 2
4V - Top Front Side Wide Corner Trim
 with 22° scarf cut bottom / 11° cut top
 (1/2" x 5 1/2" x 46 1/2") x 2

Hardware (Steps 90 - 91)
(N1 - 1 1/2" Finishing Nails) x 56 total

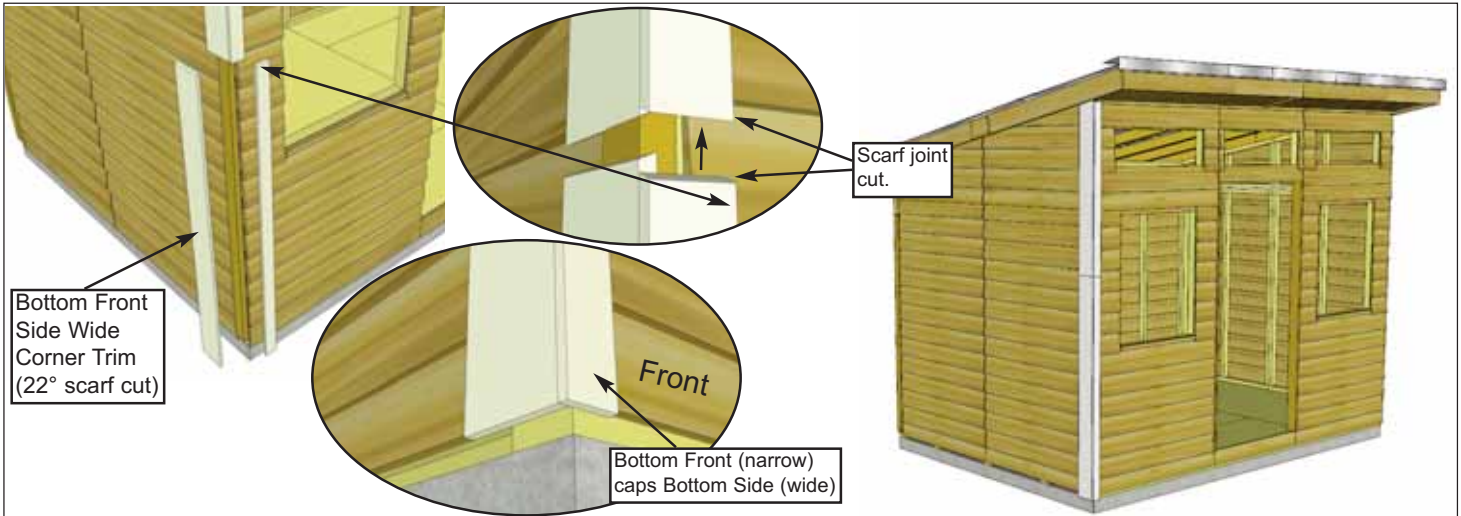

91. From the Left Corner Trim package, locate **4W - Bottom Front Narrow Corner Trim** and **4X - Bottom Front Side Wide Corner Trim**. Position scarf joint of **4W** tight underneath scarf joint of **4U - Top Front Narrow Trim** from previous step. Secure with **8 - 1 1/2" Finishing Nails**. Align scarf joint of **4X** with scarf joint of **4V - Top Wide Trim** from previous step. Attach with **8 - 1 1/2" Finishing Nails**. Locate Right Side Front Corner Trim Package and repeat as per **Steps 90**.

- Parts
- 4W - Bottom Front Narrow Corner Trim**
with 22° scarf cut top
(1/2" x 2 1/2" x 62") x 2
- 4X - Bottom Front Side Wide Corner Trim**
with 22° scarf cut top
(1/2" x 5 1/2" x 62") x 2

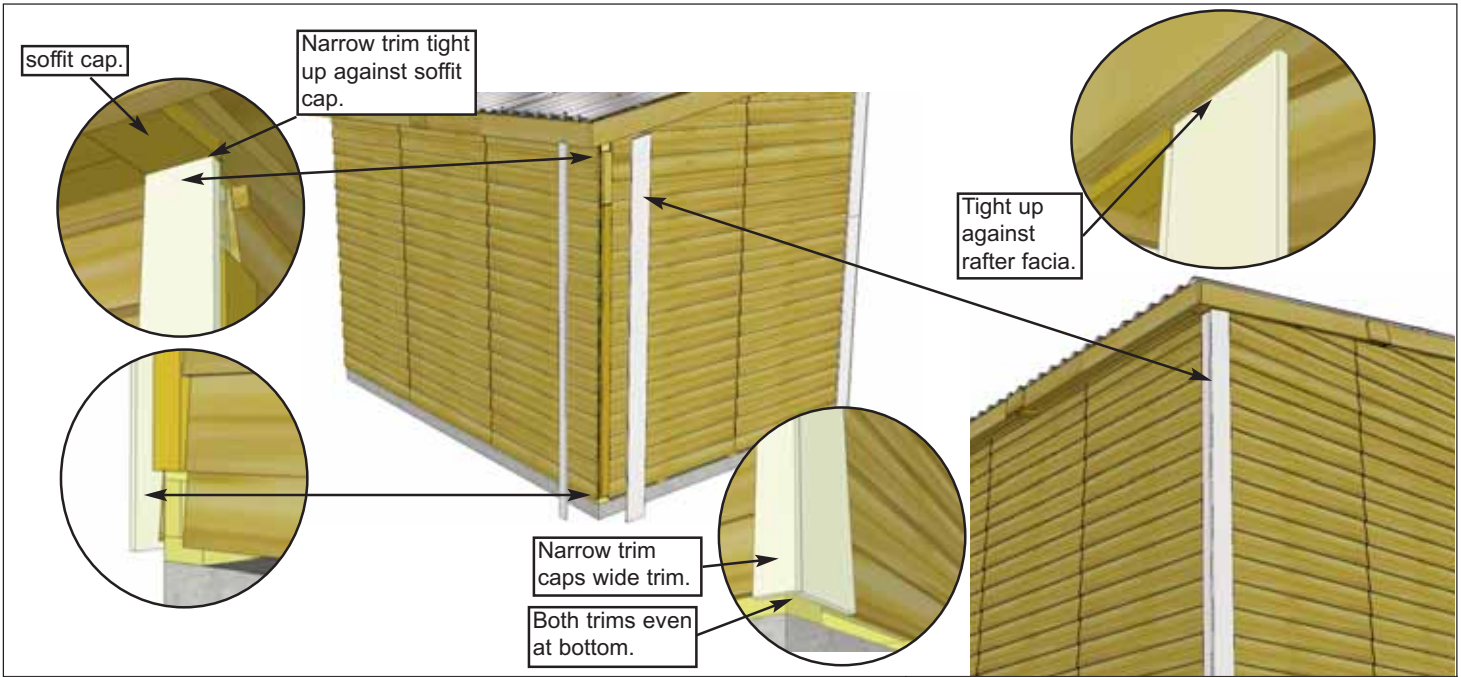

92. Start by positioning **4Z - Rear Corner Narrow Trim** tight against soffit cap on rear wall siding. Next, position **4Y - Rear Side Wide Corner Trim** on side wall so it caps the narrow trim. When correctly aligned, attach each trim with **10 - 1 1/2" Finishing Nails**. Have helper assist by holding trim. Repeat for opposite side.

- Parts
- 4Y - Rear Side Wide Corner Trim**
with 11° cut top - mirrored
(1/2" x 5 1/2" x 91") x 2
- 4Z - Rear Corner Narrow Trim**
(1/2" x 2 1/2" x 89") x 2
- Hardware
- (N1 - 1 1/2" Finishing Nails)** x 40 total

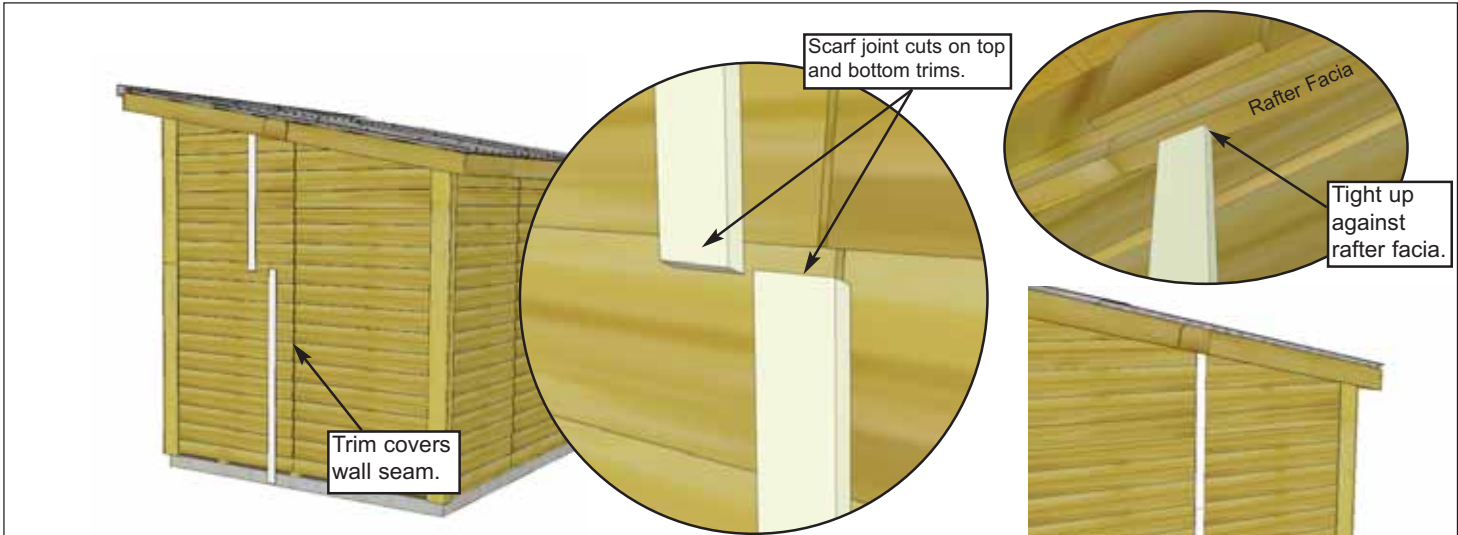

93. Place **4AB - Top Side Trim** first up against rafter fascia and evenly spaced to cover wall seam. Attach with **4 - 1 1/2" Finishing Nails**. Place **4AC - Bottom Side Trim** against wall seam and line up scarf joints. Attach with **4 - 1 1/2" Finishing Nails**. Complete other side now.

Parts
4AB - Top Side Trim
with 22° Scarf cut / 11° cut top
(1/2" x 2 1/2" x 37 3/4") x 2
4AC - Bottom Side Trim
with 22° Scarf cut top
(1/2" x 5 1/2" x 62") x 2

Hardware
N1 - 1 1/2" Finishing Nails
 x 16 total

94. Position **4AD - Rear Wall Trim** up tight underneath rear soffit and evenly spaced to cover wall seam. Attach with **8 - 1 1/2" Finishing Nails**. Complete both trims now.

Parts
4AD - Rear Wall Trim
(1/2" x 2 1/2" x 89") x 2
Hardware
(N1 - 1 1/2" Finishing Nails) x 16 total

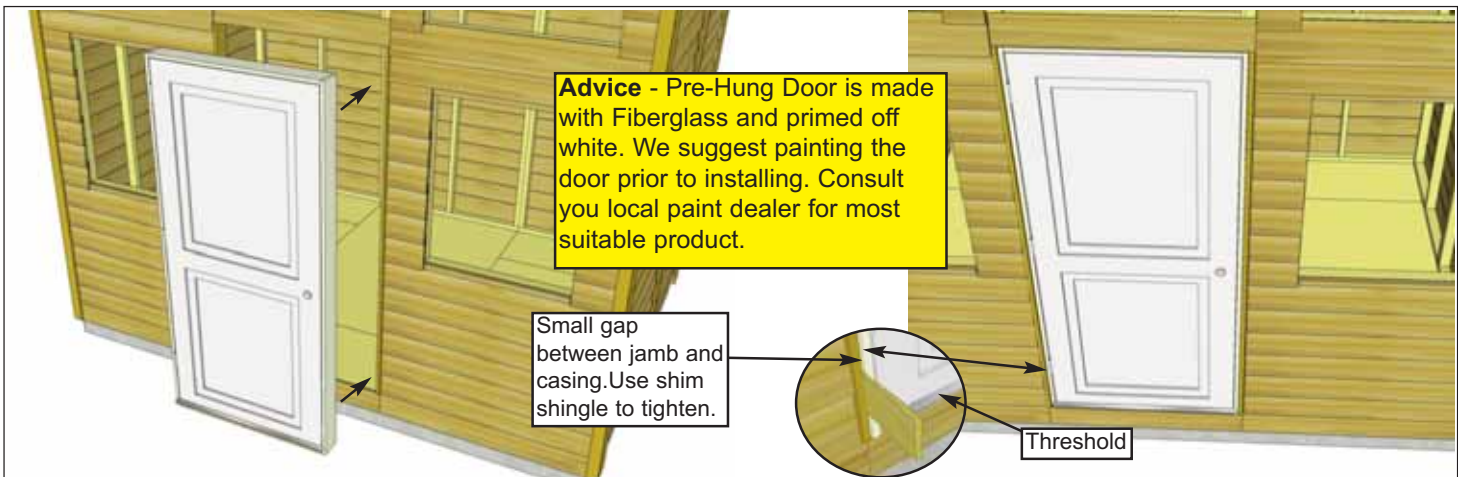

95. Locate **4AE - Pre-Hung Door**. Door opening is 38" w x 80 1/4" h. Place door in opening. Use **4AO - Shim Shingles** to shim door tight in cavity. Once shim is wedged in, cut excess shingle wood off. Insert 4-8 shim shingles.

Parts
4AE - Pre-Hung Door
(37 1/2" x 80") x 1
(4AR - Shim Shingles) x 8



96. With door leveled in opening, open door and secure casing to shed framing where you shimmed. Use **2 - 2 1/2" Screws** on top and **3 - 2 1/2" Screws** on each side. Do not screw into threshold.

Hardware
S1 - 2 1/2" Screws
 x 8 total



97. Before trimming door out, open/close door and confirm for level. Make any adjustments now. Locate **4AF - Above Door Filler Trim - Bevel**. Position over door casing with thick end of piece up and recessed slightly. Attach with **4 - 1 1/2" Finishing Nails**.

Parts
4AF - Above Door Filler Trim - Bevel
 (1/2" x 1 3/4" x 40") x 1

Hardware
(N1 - 1 1/2" Finishing Nails) x 4 total

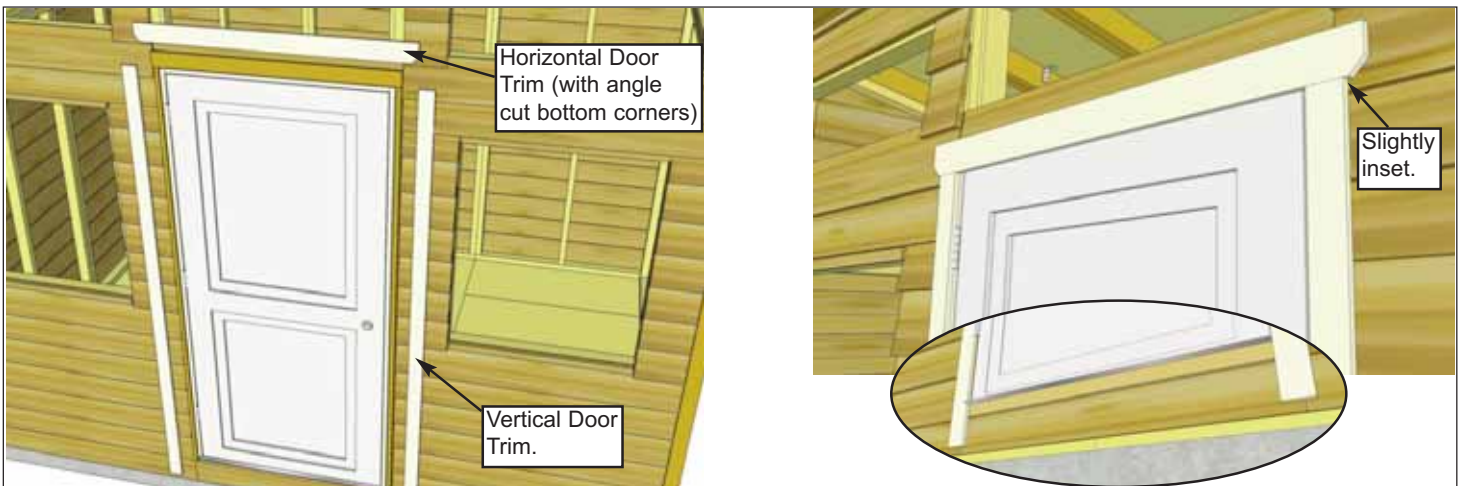

98. Position **4AG - Vertical Door Trims** and **4AH - Horizontal Door Trim** over door casing, recessed slightly. Attach **4AG** with **8 - 1 1/2" Finishing Nails** and **4AH** with **4 - 1 1/2" Finishing Nails**.

Parts
4AG - Vertical Door Trim
 (1/2" x 2 1/2" x 84") x 2
4AH - Horizontal Door Trim
 (1/2" x 3" x 44 1/2") x 1

Hardware
N1 - 1 1/2" Finishing Nails
 x 20 total



99. To reduce possible water from penetrating into the window cavity, caulk gap on both sides of window opening prior to installing the **4AI - Large Window Inserts**. Position insert in cavity and secure with **8 - 1 1/4" Screws**. Make sure to screw insert into the thick butt of the siding only.

Parts (Steps 99 - 101)
4AI - Large Window Inserts
 (30 1/4"w x 35"h) x 2

Hardware (Steps 99 - 101)
(S2 - 1 1/4" Screws) x 16 total

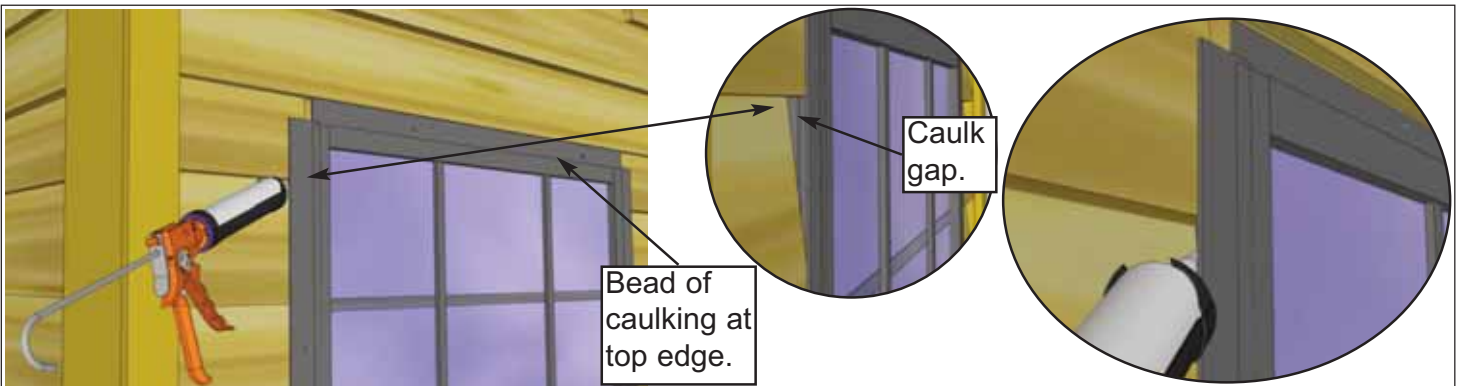

100. Once Insert is attached, caulk the "triangular gap" between the Insert's outside flange and the siding. Also put a bead of caulking horizontally at top of window where the flange and siding meet. This additional caulking will also will reduce the chances of moisture entering into your shed.

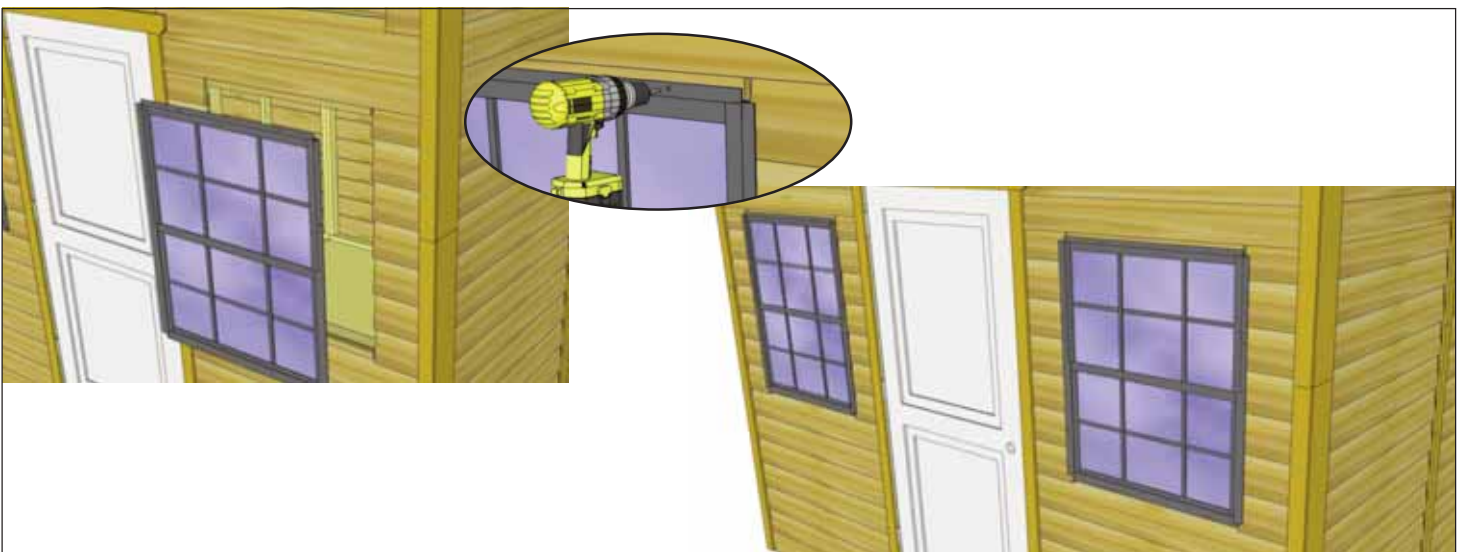

101. Insert second large window insert and attach and caulk as per **Steps 99-100**. Window Trims in **Step 103** will be installed to hide caulking.

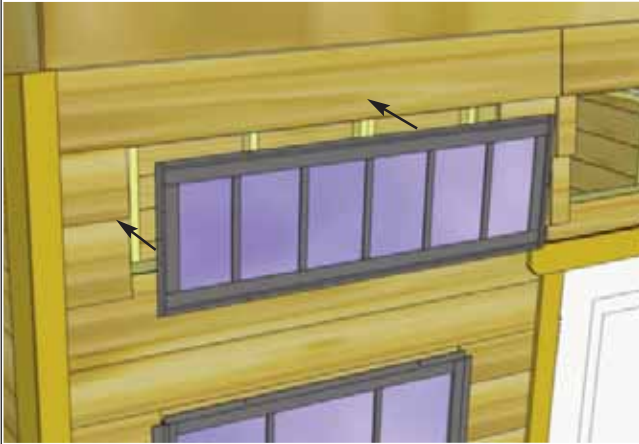

102. Install the three **4AJ - Transom Window Inserts** with **6 - 1 1/4" Screws** as per **Steps 99-100**.

Parts
4AJ - Transom Window Inserts (35"w x 10 1/8"h) x 3

Hardware
(S2 - 1 1/4" Screws) x 18 total

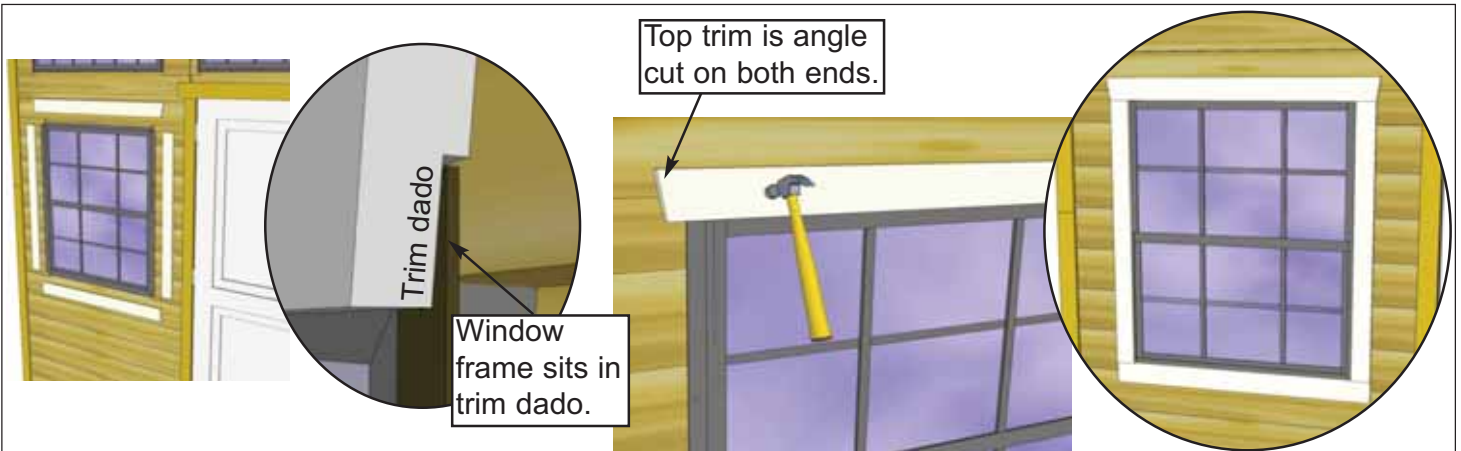

103. Position **4AK - Large Window Trims** around window, doing a dry run first. Attach with **4 - 1 1/2" Finishing Nails** per piece. Window trim has a small dado on reverse face. Outside frame of window will roughly sit in the dado to give a better fit. Complete other large window the same way.

Parts
4AK - Large Window Trims
 (1 Top piece - 36 1/4" angle cut ends) x 2
 (2 Side pieces - 36 1/8" sq.cut) x 2
 (1 Bottom piece - 35 1/4" sq.cut) x 2

Hardware
(N1 - 1 1/2" Finishing Nails) x 32 total

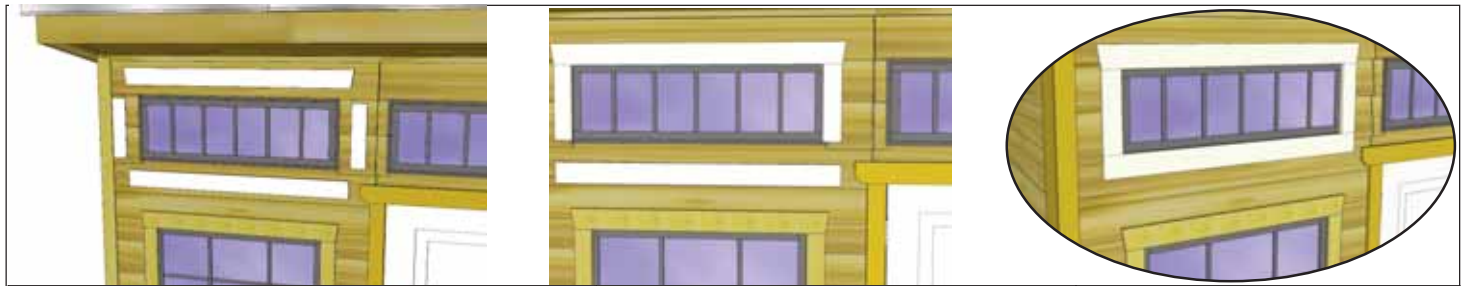

104. Position 4AL - Transom Window Trim
 Trim around window, doing a dry run first. Attach with as per **Step 103** with **4 - 1 1/2" Finishing Nails** per large piece and **2 - 1 1/2" Finishing Nails** per short piece. Complete other side window.

Parts
4AL - Transom Window Trim
 (1 Top piece - 41" angle ends) x 2
 (2 Side pieces - 10 5/8" sq.cut) x 2
 (1 Bottom piece - 40" sq.cut) x 2

Hardware
N1 - 1 1/2" Finishing Nails
 x 24 total

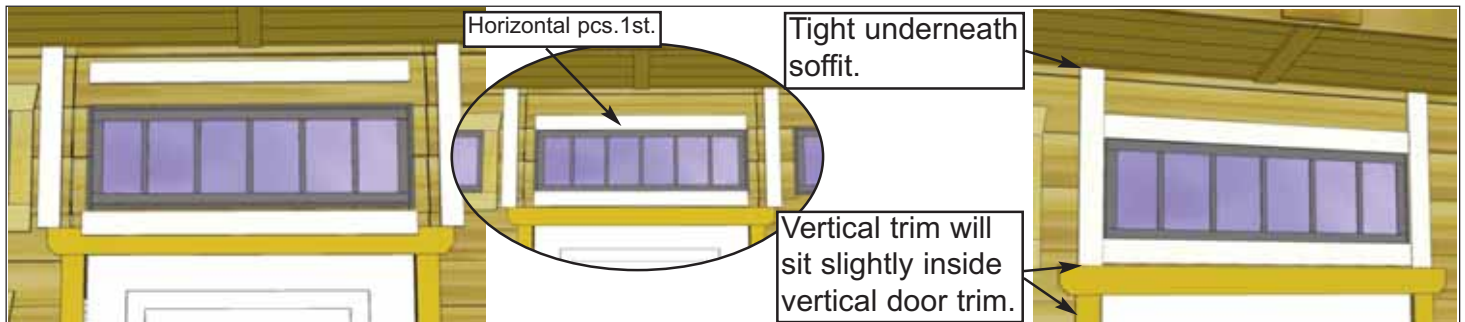

105. Position 4AM - Center Transom Window Trim around window doing a dry run first. Attach horizontal trim first and then the verticals with **4 - 1 1/2" Finishing Nails** per piece.

Parts
4AM - Center Transom Window Trim
 (Top & Bottom pieces - 35 3/4" sq. cut) x 2
 (Side pieces - 20 1/2" sq.cut) x 2

Hardware
N1 - 1 1/2" Finishing Nails
 x 16 total

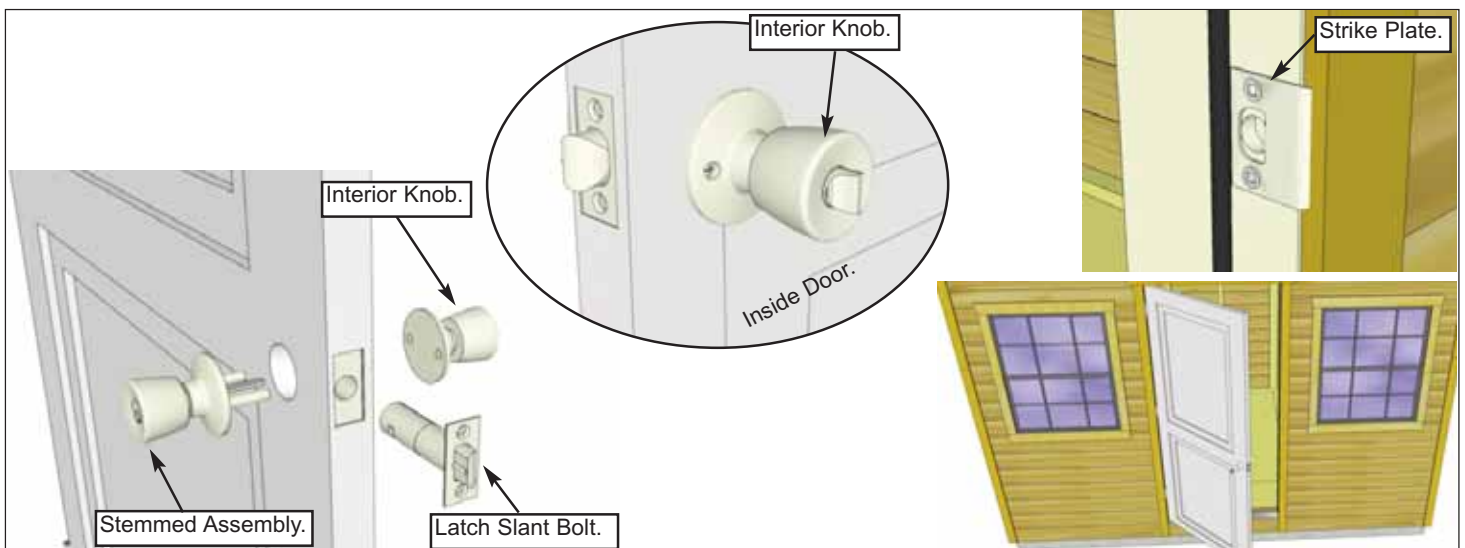

106. Locate Door Knob Package. Included in the package will be the **Stemmed Assembly, Interior Knob, Latch Slant Bolt, Strike Plate** and **Screws** (Phillips Head Screw Driver Required). Insert Latch with Slant Bolt facing to the interior of the shed. Install Stemmed Assembly. Install Interior Knob with screws (Robertson Screw Driver may be required). Install Strike Plate on Door Casing. Open and close door and make any adjustments necessary.



Congratulations on assembling your 12x8 Studio Garden Shed!

Note: Our Sheds are shipped as unfinished products. If exposed to the elements, the western red cedar lumber will weather to a silvery-gray color. If you prefer to keep the cedar lumber looking closer to the original color, we suggest that you treat the wood with a good oil base wood stain. You may also wish to paint your new shed rather than stain it. In both cases we recommend that you consult with a paint and stain dealer in your area for their recommendations.

We hope your experience assembling your 12x8 Studio Garden Shed has been both positive and rewarding.



We value your feedback and would like to hear back from you on how well we are doing in the following areas:

1. **Customer Service**
2. **On Time Shipping**
3. **Motor Freight Delivery**
4. **Quality of Materials**
5. **Assembly Manual**
6. **Overall Satisfaction.**

Please call, write or email us at:

Outdoor Living Today

Canadian Address
9393 287th Street
Maple Ridge, British Columbia
Canada V2W 1L1

United States Address
P.O. Box 96
Sumas, Washington
USA 98295



The materials contained in this Assembly Manual may be downloaded or copied provided that ALL copies retain the copyright and any other proprietary notices contained on the materials. No material may be modified, edited or taken out of context such that its use creates a false or misleading statement or impression as to the positions, statements or actions.