



# 12x16 SunShed Garden Shed AK Bevel Model with Plywood Roof Assembly Manual

Revision #1.4  
October 4, 2022

Stock Code  
SSGS1216-AK-Ply

Thank you for purchasing a 12x16 SunShed Garden Shed from Outdoor Living Today. Please take the time to identify all the parts prior to assembly.



## Safety Points and Other Considerations

Our products are built for use based on proper installation and normal residential use, on level ground. Please follow the instruction manual when building your shed and retain the manual for future maintenance purposes.

Some of the safety and usage measures you may wish to consider include:

- snow load ratings vary by geographical location. If heavy or wet snowfall occurs, it is advisable to sweep the snow off the roof(s).
- if the product is elevated, any structural and building code requirements are solely the customer's responsibility, and should be abided by.
- in high or gusty wind conditions it is advisable to keep the structure securely grounded.
- have a regular maintenance plan to ensure screws, doors, windows and parts are tight.

Customer agrees to hold Outdoor Living Today free of any liability for improper installation, maintenance and repair of any of our products.

In the event of a missing or broken piece, simply call the Outdoor Living Today Customer Support Line @ 1-888-658-1658 within 30 days of the delivery of your purchase. It is our commitment to you to courier replacement parts, free of charge, within 10 business days of this notification. Replacement parts will not be provided free of charge after the 30 day grace period.

# What to do before my Shed arrives?



- Become familiar with this assembly manual and determine if you can complete the project yourself or will require a professional contractor.



- One helper is recommended to assist in constructing your shed. It generally takes two people 3 to 4 days to assemble a shed. If you're hiring a contractor, their rate should be in line with that duration of work.



- Clear the construction area and ensure a clear pathway for delivery when the freight company arrives. Remove all debris: roots, grass, rocks, etc.



- Excavate the site. Contact your local utilities company to ensure there are no gas or electric lines buried in the area before digging.



- Decide on the type of foundation you will be using:
  - Concrete slab, or
  - 4-6 inches of crushed gravel with paver stones or 4x4 stringers.

You can find the footprint for your shed on Page 3 of your Assembly Manual.



- If doing the assembly yourself, have all the necessary tools ready to go and in working condition. A list of required tools can be found after the parts list.

# Foundation Types for 12x16 Garden Shed

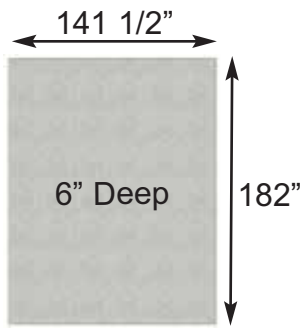

**Concrete Foundation**

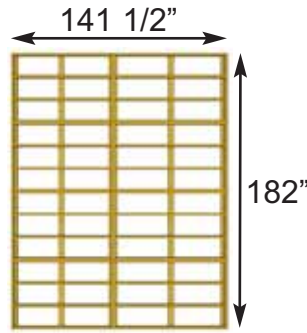

**Floor Frame**

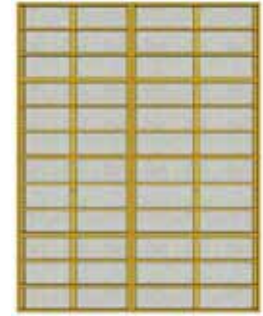

**Completed Foundation**

**Concrete Slab Foundation:**

- Slab must be at least the same size as assembled floor frame (141 1/2" x 182") or larger.
- 6" Deep foundation.
- 3.4 Cubic Yards of concrete required.
- A concrete slab will have the longest durability out of your foundation options.

**Once level, a concrete slab is the easiest surface to build on.**

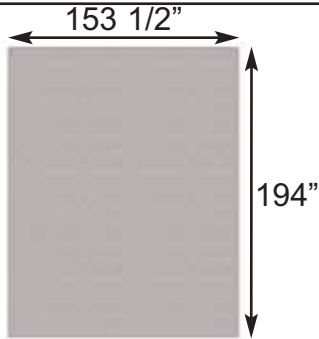

**Gravel Foundation**

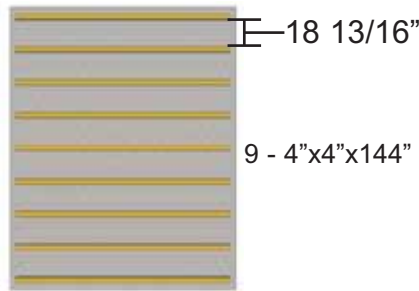

**Gravel Foundation with treated stringers**



**Completed Foundation**

**Gravel with 4x4 Pressure Treated Stringers:**

- Excavate at least 6" deep, and 6" wider than floor frame on each side.
- 3.9 Cubic Yards of gravel required, approximately 36 wheelbarrows.
- 9 - 4x4 Pressure Treated Stringers 12' long required.
- Evenly spaced, with one at each end of floor frame.

**Saves money on materials, easy to level and work with.**

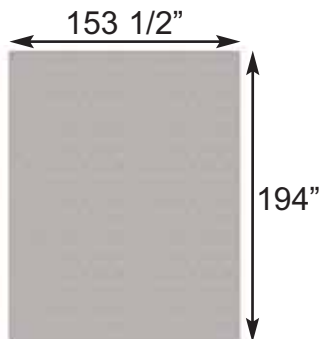

**Gravel Foundation**

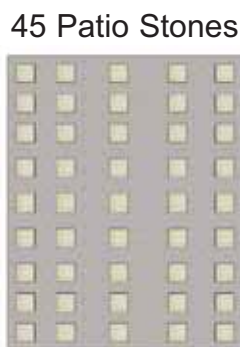

**Gravel Foundation with Patio Pavers**

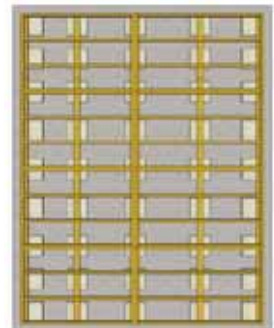

**Completed Foundation**

**Gravel with Patio Paver Stones:**

- Excavate at least 6" deep, and 6" wider than floor frame on each side.
- 3.9 Cubic Yards of gravel required, approximately 36 wheelbarrows.
- 45 patio pavers (8" x 8" or larger).
- Center patio paver stones underneath floor runners and underneath seams in floor joists.

**Patio paver stones are widely available from most landscape stores.**

**Thank you for purchasing our 12x16 Sunshed Garden Shed.  
Please take the time to identify all the parts prior to assembly.**

<b>1. Floor Section</b>	<b>Parts List - Page 4-5</b>	<b>Steps ↓</b>
<b>Floors</b>	4 - 45 1/2" x 75" - Floor Joist Frames - Large 4 - 45 1/2" x 66 1/2" - Floor Joist Frames - Small 8 - 1 1/2" x 3 1/2" x 72" - Floor Joists Large - Unattached 8 - 1 1/2" x 3 1/2" x 63 1/2" - Floor Joists Small - Unattached 2 - 1 1/2" x 5 1/2" x 56" - Wide Floor Runner 1 - 1 1/2" x 5 1/2" x 70" - Wide Floor Runner 4 - 1 1/2" x 3 1/2" x 38" - Floor Runners 8 - 1 1/2" x 3 1/2" x 72" - Floor Runners 4 - 5/8" x 45 1/2" x 75" - Floor Plywood Large 4 - 5/8" x 45 1/2" x 66 1/2" - Floor Plywood Small	<b>1 - 11</b>
<b>2. Wall Section</b>	<b>Main Wall Panels</b> 4 - 45 1/2" x 81 3/4" - Solid Wall Panels 1 - 45 1/2" x 81 3/4" - Solid Wall Panel With Extra Vertical Studs 5 - 1 1/2" x 2 1/2" x 45 1/2" - Bottom Wall Plates 4 - 45 1/2" x 81 3/4" - Window Wall Panels 4 - 45 1/2" x 81 3/4" - Double Window Walls 1 - 12" x 73" - Narrow Wall Panel	<b>12 - 20</b>
	<b>Door Headers</b> 1 - 1 1/2" x 3 1/2" x 73" - Vertical Door Jamb 1 - 1 1/2" x 2 1/2" x 45 1/2" - Door Header Riser 1 - 1 1/2" x 7 1/4" x 45 1/2" - Door Header 2 - 1/2" x 7 1/4" x 45 1/2" - Door Header Spacer 1 - 45 1/4" long - Drip Edge with Bevel Siding attached	<b>21 - 26</b>
	<b>Top Wall Plates &amp; Gables</b> 4 - 1 1/2" x 2 1/2" x 70 3/4" - Front & Rear Riser Plates 4 - 1 1/2" x 2 1/2" x 88 1/2" - Side Riser Plates 4 - 3/4" x 2 1/2" x 45" - Front & Rear Top Plates (angle cut ends) 2 - 3/4" x 2 1/2" x 51 1/2" - Front & Rear Top Plates (straight cut ends) 2 - 3/4" x 2 1/2" x 45 1/2" - Side Top Plates (angle cut edge) 4 - 3/4" x 2 1/2" x 65 3/4" - Side Top Plates (angle cut edge) 4 - Triangular Gable Walls (end tip tucked inside)	<b>27 - 32</b>
<b>3. Rafter and Roof Section</b>	<b>Rafter Assembly</b> 3 - 3/4" x 9 1/4" x 91" - Roof Ridge Boards 2 - 3/4" x 9 1/4" x 45 1/2" - Roof Ridge Boards 24 - 1 1/2" x 3 1/2" x 80 7/8" - Roof Rafters (angle cut ends) 4 - 1/2" x 4 1/2" x 91" - Soffits 4 - 3/4" x 80" x 19 3/4" - Triangular Roof Gussets 12 - 3/4" x 3/4" x 48" - Polygal Support Cleats Long 4 - 3/4" x 3/4" x 38" - Polygal Support Cleats Short	<b>33 - 49</b>
	<b>Roof</b> 2 - 5/8" x 48" x 81 1/2" - Long Left & Right Plywood Panels 2 - 5/8" x 45 1/2" x 81 1/2" - Long Center Plywood Panels 2 - 5/8" x 48" x 37 1/2" - Short Left & Right Plywood Panels 2 - 5/8" x 45 1/2" x 37 1/2" - Short Center Plywood Panels 8 - 48" long - Polygal Panels	<b>50 - 66</b>

Continued on next page

4. Trim & Miscellaneous Section	Steps ↓
<p><b>Outer Wall Trim &amp; Dutch Door</b> -----</p> <ul style="list-style-type: none"> <li>14 - 1/2" x 4 1/2" x 45 1/4" - Bottom Skirting (Bevel)</li> <li>1 - 1/2" x 2 1/2" x 79" - Narrow Door Trim</li> <li>2 - 1/2" x 3 1/2" x 85" - Door Trims</li> <li>1 - Dutch Door with Hardware</li> <li>8 - 3/4" x 1 1/2" x 45 1/4" - Top Wall Trims</li> <li>4 - 3/4" x 2 1/2" x 81 3/4" - Filler Trims</li> <li>10 - 1/2" x 2 1/2" x 87" - Side Trims</li> <li>4 - 1/2" x 5 1/2" x 90" - Wide Corner Trims</li> <li>2 - 1/2" x 2 1/2" x 85" - Rear Wall Trims</li> <li>2 - 1/2" x 5 1/2" x 44" - Outside Polygal Ridge Caps</li> <li>3 - 1/2" x 4 1/2" x 44" Center Polgal Ridge Caps</li> <li>4 - 1/2" x 2 1/2" x 44" Mid Polygal Ridge Caps</li> </ul>	67 - 80
<p><b>Facia Trim</b> -----</p> <ul style="list-style-type: none"> <li>2 - 3/4" x 1 1/2" x 36 1/2" - Facia Cleat Short</li> <li>4 - 3/4" x 1 1/2" x 40" - Facia Cleat Long</li> <li>4 - 3/4" x 5 1/2" x 81 1/4" - Front and Rear Facia Angled</li> <li>4 - 3/4" x 5 1/2" x 49 1/2" Side Facia</li> <li>2 - 3/4" x 5 1/2" x 89 1/4" - Side Facia</li> <li>1 - 1/2" x 2 1/2" x 8" - Horizontal Door Trim</li> <li>1 - 1/2" x 2 1/2" x 32" - Horizontal Door Trim</li> <li>2 - 3/4" x 4 1/2" x 42" - Horizontal Gable Trims - Bevel</li> <li>4 - 3/4" x 4 1/2" x 45 1/4" - Horizontal Gable Trims - Bevel</li> <li>2 - 9 1/2" x 7 1/2" - Pentagon Detail Plates</li> <li>8 - 8" x 5 1/2" Facia Detail Plates</li> </ul>	81 - 89
<p><b>Miscellaneous</b> -----</p> <ul style="list-style-type: none"> <li>2 - 1/2" x 2 1/2" x 72" - Interior Vertical Door Stops</li> <li>1 - 1/2" x 2 1/2" x 36" - Interior Horizontal Door Stop</li> <li>4 - Regular Window Inserts</li> <li>8 - Narrow Window Inserts</li> <li>4 - Regular Window Trim Pkgs</li> <li>8 - Narrow Window Trim Pkgs</li> <li>8 - Flower Box Kits</li> <li>4 - 16" x 45" - Long Potting Shelves</li> <li>1 - 16" x 41" Short Potting Shelf</li> <li>9 - 1 1/2" x 2 1/2" x 38" - Potting Shelf Legs</li> <li>1 - Extra Lap Siding</li> <li>1 - Spare Wall Siding</li> <li>2 - Spare Shingles - use to shim door, etc</li> </ul>	90 - 95

**Advice:** Wood has a tendency to split when screwing near the ends of a board. To prevent splitting, it is always recommended to pre-drill pilot holes before screwing into these areas.



# 12x16 SUNSHED WITH PLYWOOD ROOF HARDWARE SHEET

## Hardware Kit (Provided)

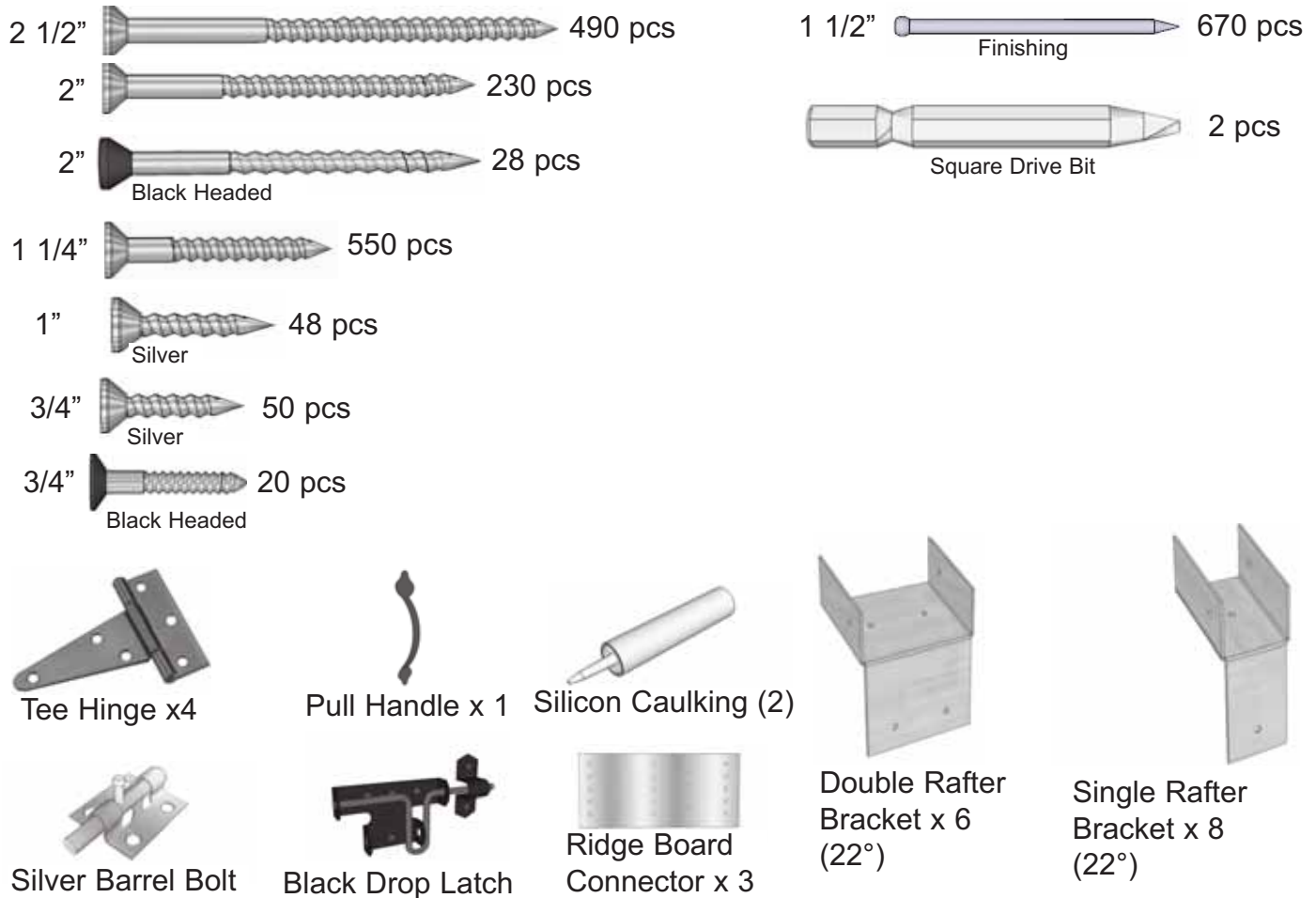

## Tools Required (Not Provided)



## Safety Equipment Required (Not Provided)



## Before/During Assembly:

- 1.) Paint each face and edge of your plywood floor with a latex exterior paint.
- 2.) Caulk wall seams if gaps appear.
- 3.) Caulk around window framing.
- 4.) Caulk perimeter between floor plywood and bottom wall plate.
- 5.) Caulk channels in lap siding at the top of your door above the trim, just a drop in each channel.
- 6.) Caulk edge of door threshold (if applicable).
- 7.) Optional: Install a Sill Gasket between floor runners and foundation.
- 8.) Optional: Install an 8" strip of roofing paper below Cedar Ridge Caps for Cedar Roof Sheds.

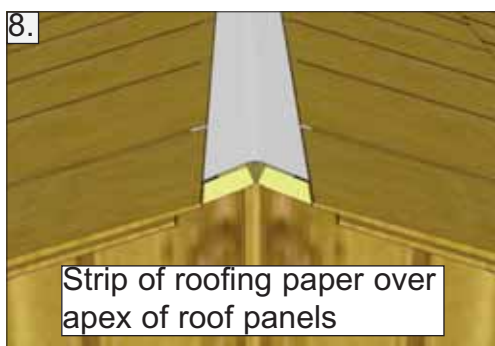
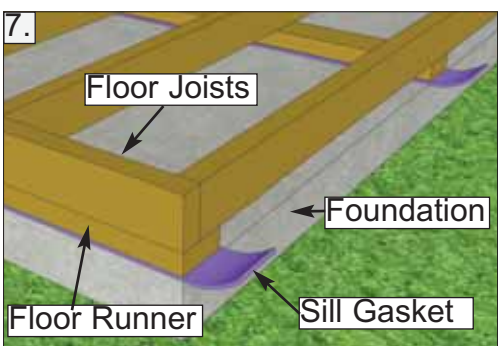
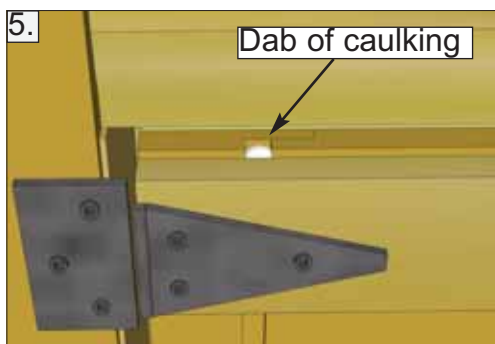
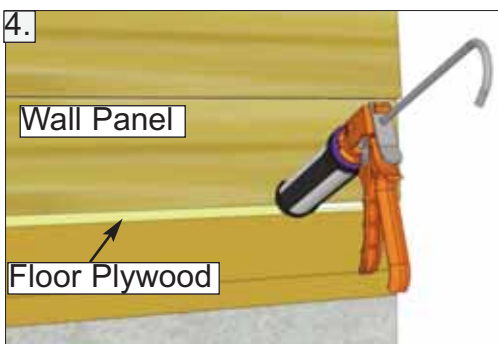
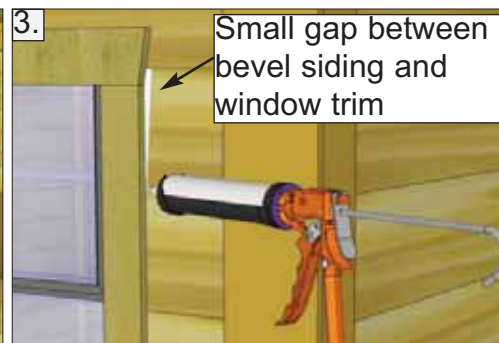
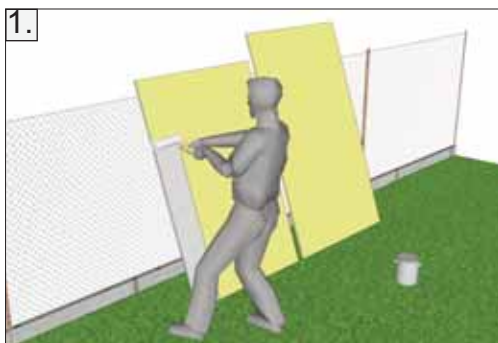

## Routine Maintenance:

- Routinely check all fasteners are tight (ex. Door Hinges, Nails)
- Brush off dirt from walls.
- Brush off snow from roof regularly.
- Routinely remove needles and leaves from roof.

## Painting/Staining

- Your cedar shed, if left untreated, will weather to a silvery grey colour.
- Painting or staining your structure is highly recommended and will prolong the life of your shed.
- You do not need to wait to paint or stain your shed, the wood in your kit has been dried and can be stained or painted immediately.
- Consult your local paint store for the best paint or stain for cedar.
- Optional: stain the inside of your shed. (Note: this will remove the fresh cedar smell.)

# A. Floor Section

Exploded view of all parts necessary to complete Floor Section. Identify all parts prior to starting. Note, Floor Footprint is 182" deep x 141 1/2" wide.

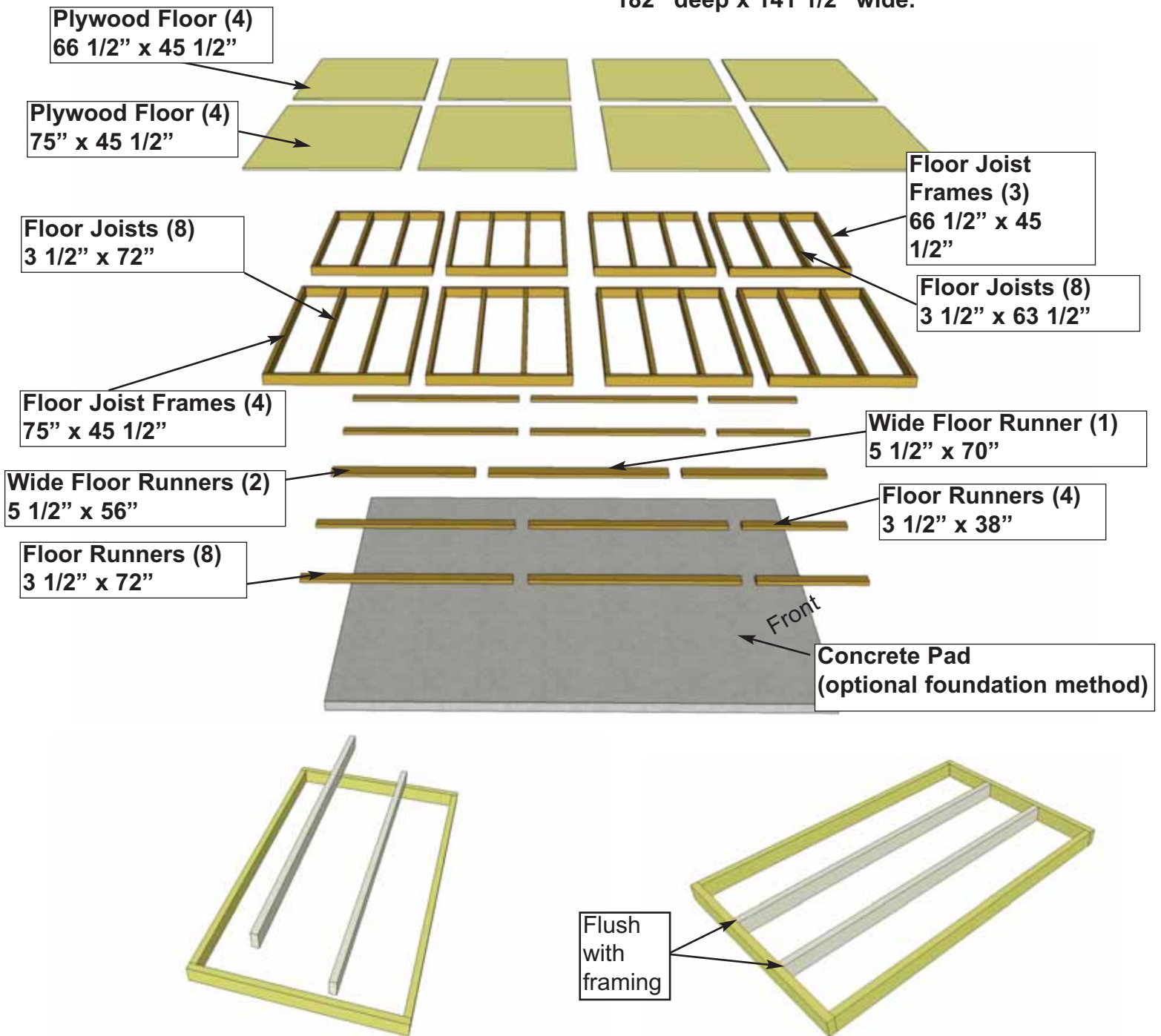

**1.** Lay out all **Floor Joist Frames** and **Floor Joists** on ground as illustrated above. Position 72" Floor Joists in 75" frames and 63 1/2" Floor Joists in 66 1/2" frames. Position Joists equally in Floor Joist Frame. Position Joist so flush with framing.

Parts (Steps 1 - 3)  
**Floor Joists - Large**  
 (1 1/2" x 3 1/2" x 72") x 8  
**Floor Joists - Small**  
 (1 1/2" x 3 1/2" x 63 1/2") x 8  
**Floor Joist Frames - Large**  
 (45 1/2" x 75") x 4  
**Floor Joist Frames - Small**  
 (45 1/2" x 66 1/2") x 4

Hardware (Steps 1 - 3)  
**S1 - 2 1/2" Screws**  
 x 58 total



You can find the Square Drive Bit for the screws in with the Hardware Kit Bag.

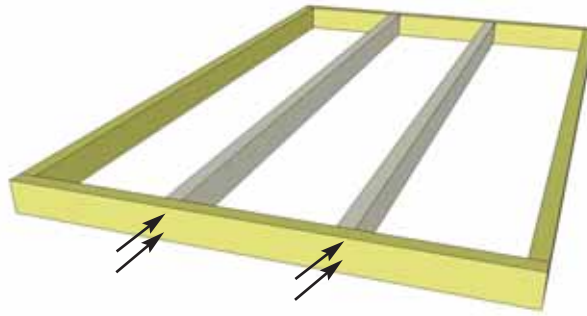

**2.** When correctly positioned, attach each Joist with 4 - 2 1/2" screws (2 per end). Complete all Floor Frame and Joist connections. You can find the Square Drive Bit for the screws in with the Hardware Kit Bag.



**3.** Lay out 75" Floor Frames as shown above. Attach each completed frame to the next with 8 - 2 1/2" screws (24 Total). Once complete assemble 66 1/2" Floor Frames the same way.

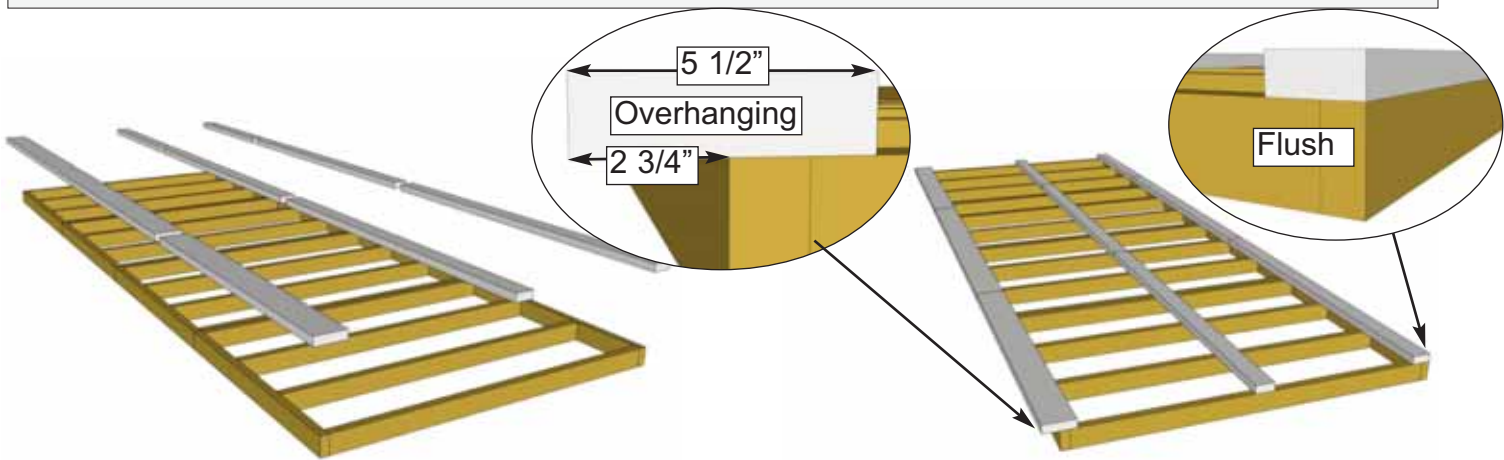

**4.** Locate Floor Runners and Wide Floor Runners. Lay out Floor Runners above Completed Floor Frame section as shown above. The 3 1/2" wide Floor Runner should be flush with the edge of the floor frame. 5 1/2" wide Floor Runner should overhang the edge of the floor Frame by 2 3/4". Third set of Floor Runners should be centered on Floor Frame.

**Parts (Steps 4 - 9)**  
**Wide Floor Runners**  
 (1 1/2" x 5 1/2" x 56") x 2  
**Wide Floor Runner**  
 (1 1/2" x 5 1/2" x 70") x 1  
**Floor Runners**  
 (1 1/2" x 3 1/2" x 38") x 4  
**Floor Runner**  
 (1 1/2" x 3 1/2" x 72") x 8

**Hardware (Steps 4 - 9)**  
**S1 - 2 1/2" Screws**  
 x 116 total

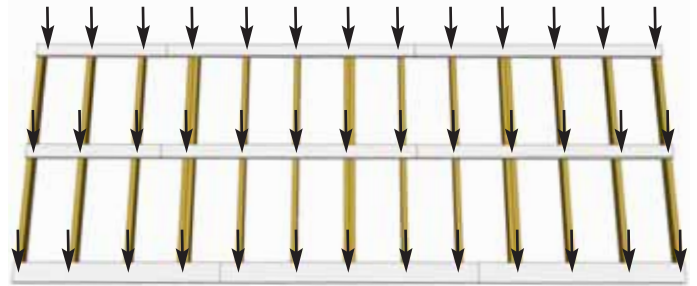
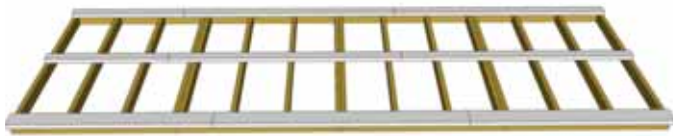

**5.** Attach **Floor Runners to Floor Frames** with **13 - 2 1/2" screws** per completed runner length (**39 Total**). For **Wide Floor Runner** use 4 screws in the 56" pieces and 5 screws in the 70" piece. For the **3 1/2" Floor Runner** use 5 screws for the 72" pieces and 3 screws for the 38" pieces.

### Foundations

**Note:** The floor will be flipped over and floor runners will sit on your foundation. It is important to note that having a level foundation is critical. Choosing a foundation will vary between regions. Typical foundations can be concrete pads or patio stones positioned underneath the floor runners.

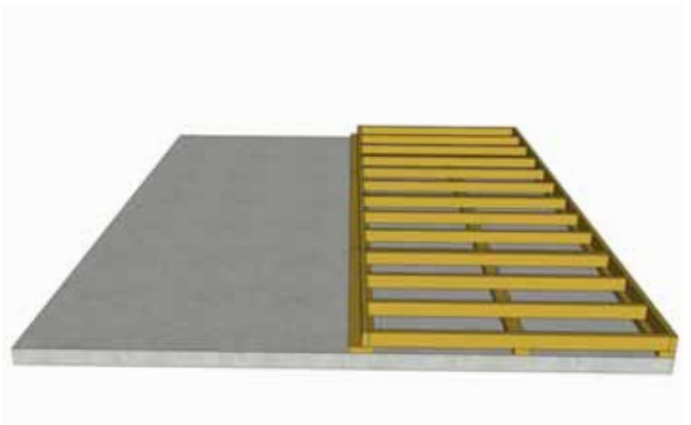
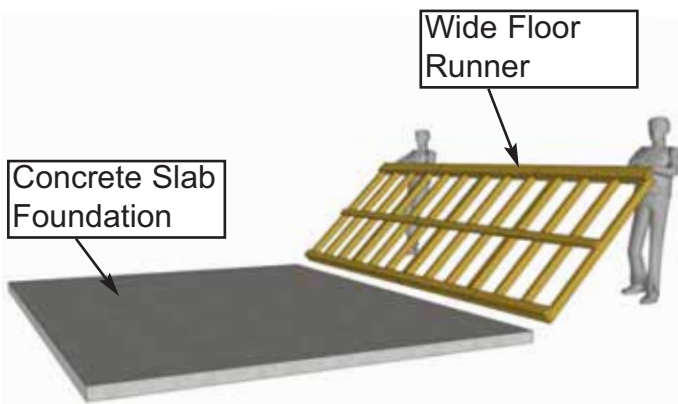

**6.** With some helpers, flip the floor section over so it rests on your foundation. **Wide Floor Runner** should rest in the center of your foundation. **Caution:** you will need 2 people to assist you. Be careful when laying floor down not to bend or twist floor. When in place, level floor completely.

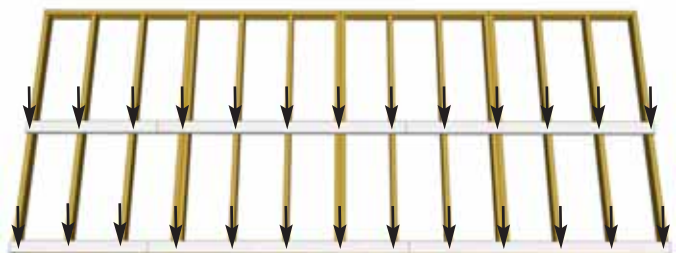

**7.** Lay out Remaining **Floor Runners** on second floor frames ( 4x 72" Runners and 2x 38" Runners). Attach remaining runners with a total of **26 - 2 1/2" screws** as per **Step 5**.

Edge without Floor Runner

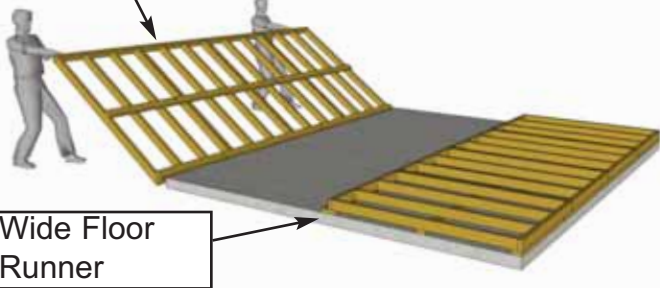

Wide Floor Runner

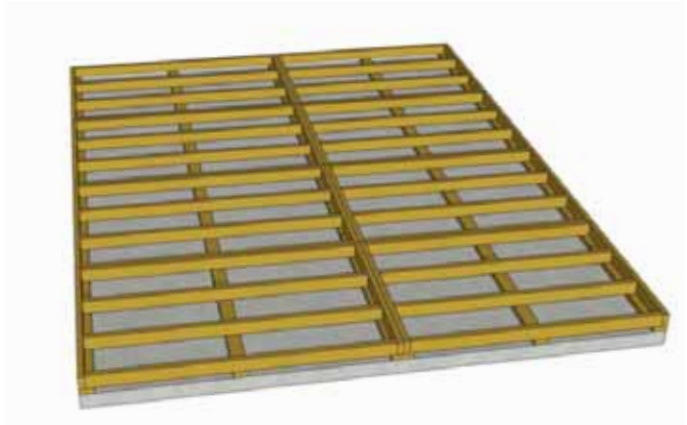

**8.** With a helper, flip remaining floor section over onto your foundation. Edge of frame without floor runner should land on wide floor runner.

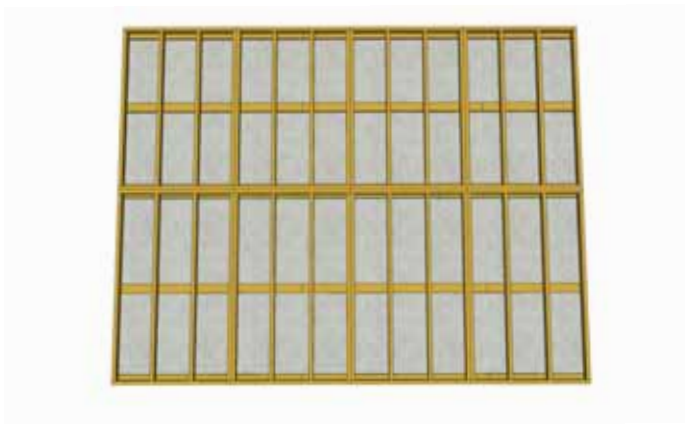
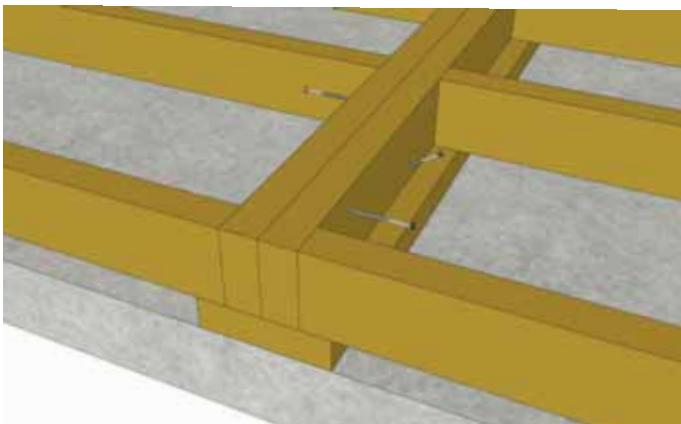

**9.** To attach floor sections together attach each **75" Frame** to **66 1/2" Frame** with **3 - 2 1/2" screws (36 Total)**. Use 2 screws on both sides to attach horizontally. On the 66 1/2" Frame side toenail one screw into the **Wide Floor Runner**.

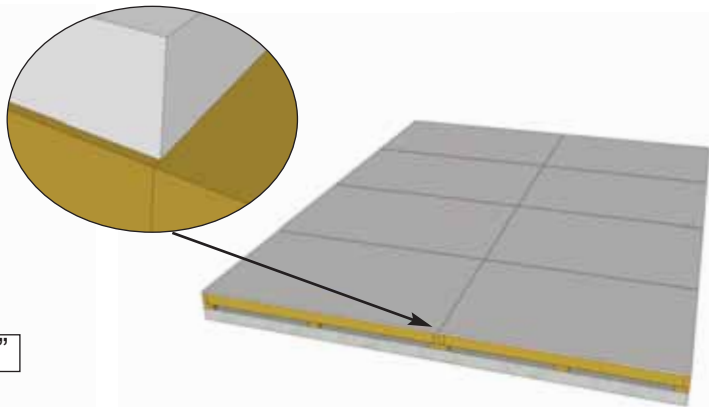
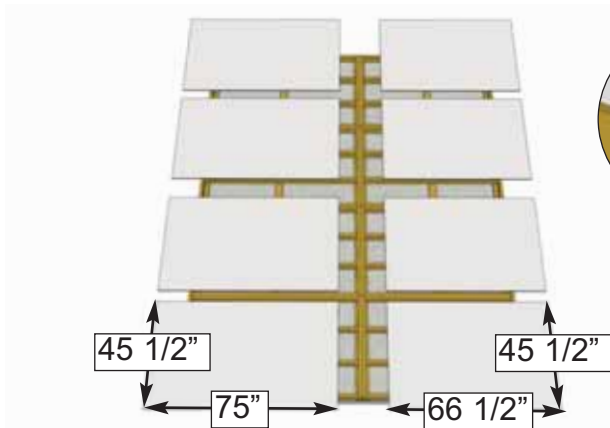

**10.** Position **Plywood Floor** pieces (8) on top of completed **Floor Joists**. Plywood will sit slightly back from edge of **Floor Joist Framing**.

Parts (Steps 10 - 11)  
**Floor Plywood - Large**  
 (5/8" x 45 1/2" x 75") x 4  
**Floor Plywood - Small**  
 (5/8" x 45 1/2" x 66 1/2") x 4

Hardware (Steps 10 - 11)  
**S2 - 1 1/4" Screws**  
 x 120 total

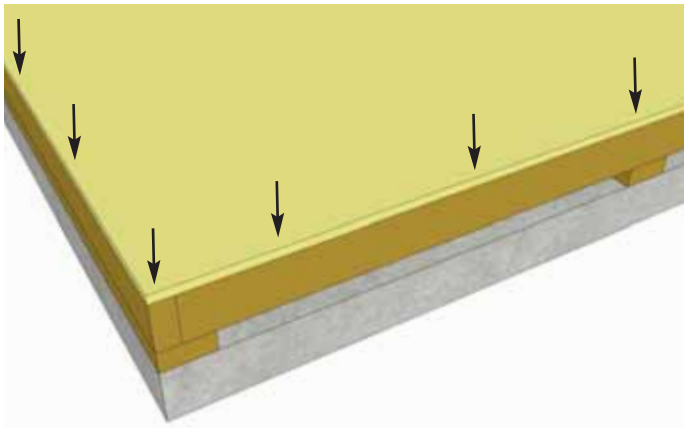

**Hint:** Use a chalk line to mark location of floor joists to determine screw placement.

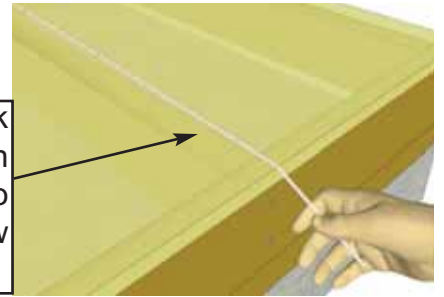

**11.** With **Floor Plywood** pieces in position, attach with **1 1/4" screws**. Use screws every 16" (approximately 120 total). The plywood is cut slightly smaller than floor framing. Keep plywood seams tight.

**Important:** Check to confirm that your floor is level prior to proceeding to the next step of wall assembly.

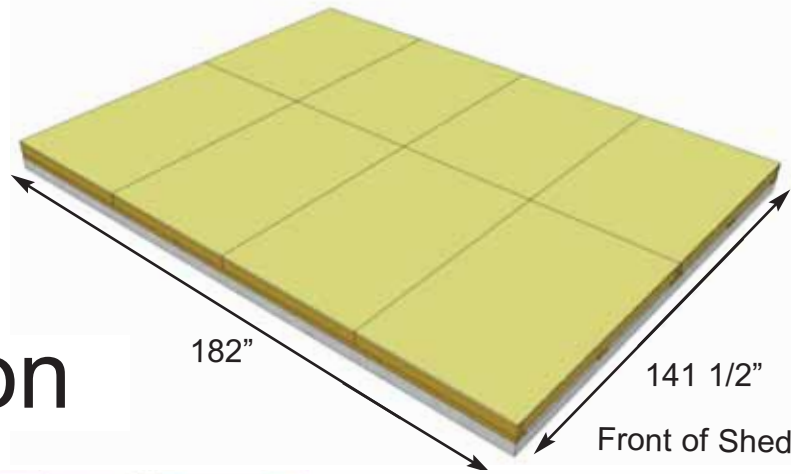

## B. Wall Section

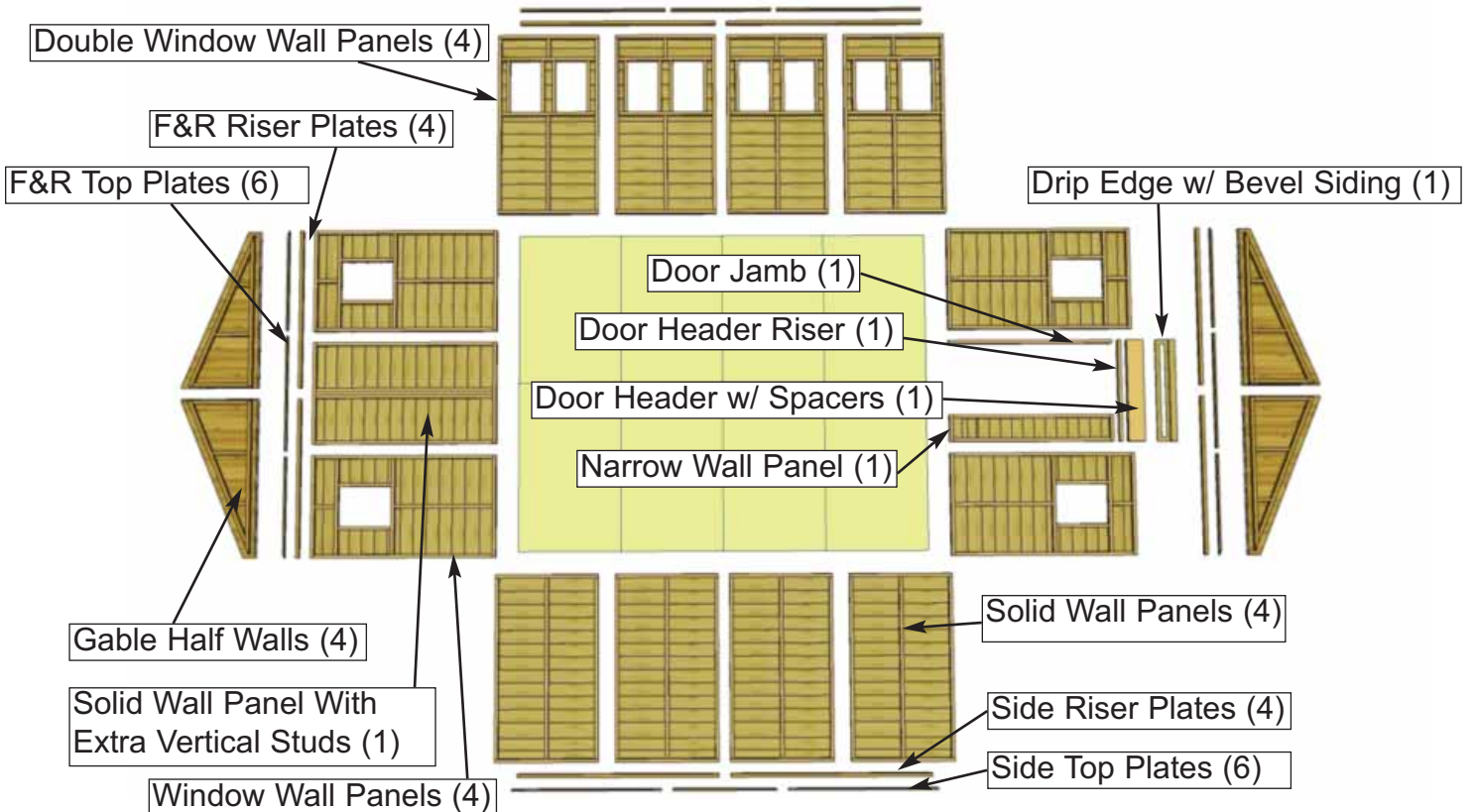

**Important:**

Pilot hole **ALL** 2x3 Wall Studs with 1/8" drill bit prior to screwing. This will make it much easier to attached together.

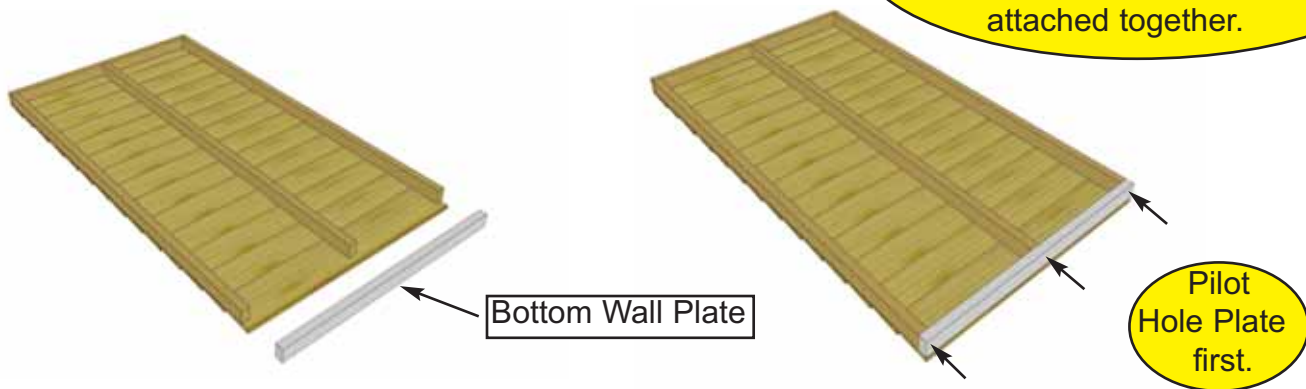

**12.** Starting with **Solid Wall Panels**, carefully lay panel face down. Position and attach **Wall Plate** to bottom of wall studs of each **Wall Panel** with **3 - 2 1/2" screws**. Position so plates are flush with framing. **Note:** Bottom Wall Plates may already be attached to some Solid Walls.

Parts (Step 12)  
**Solid Wall Panels**  
 (45 1/2" x 81 3/4") x 4  
**Solid Wall Panel - Extra Studs**  
 (45 1/2" x 81 3/4") x 1  
**Bottom Wall Plates**  
 (1 1/2" x 2 1/2" x 45 1/2") x 5

Hardware (Step 12)  
**S1 - 2 1/2" Screws**  
 x 15 total

**Important:** Make sure all walls are aligned in their upright position. If not, water may leak into your shed. Unsure if panel is facing up or down? check siding on window wall panel to match alignment.

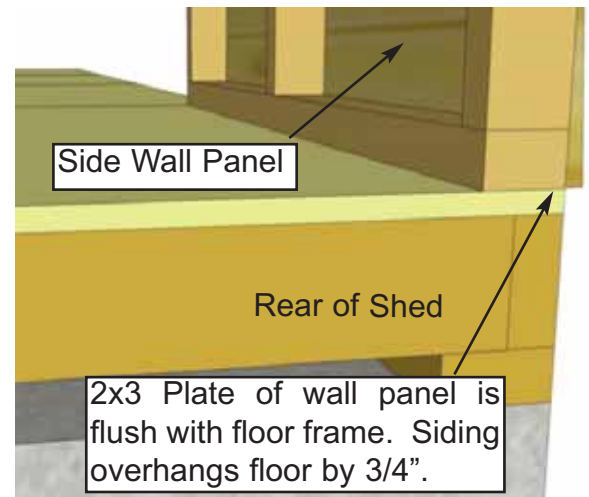
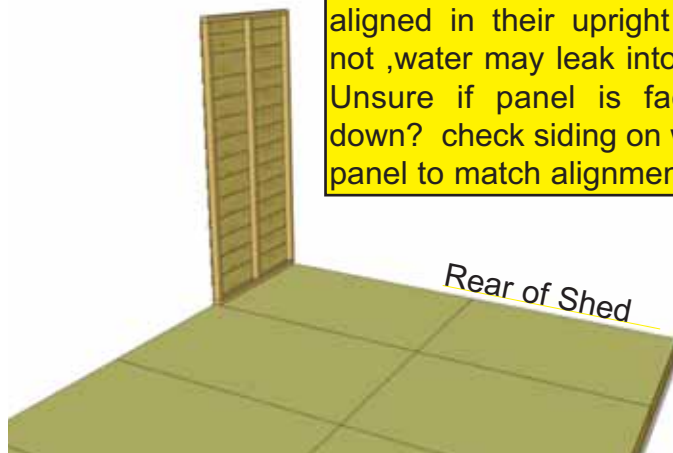

**13.** Starting at Rear Corner, position a **Solid Wall Panel** on top of plywood floor. Make sure panel is facing up. The **Side Wall Panels** will sit flush with floor frame with the front and rear panels sandwiched between them. **Note:** siding will overhang the floor by approx. 3/4".

Parts (Step 13)  
**Solid Wall Panels**  
 (45 1/2" x 81 3/4") x 4  
**Solid Wall Panel - Extra Studs**  
 (45 1/2" x 81 3/4") x 1  
**Window Wall Panels**  
 (45 1/2" x 81 3/4") x 4  
**Double Window Walls**  
 (45 1/2" x 81 3/4") x 4

Hardware (Step 13)  
**S1 - 2 1/2" Screws**  
 x 39 total

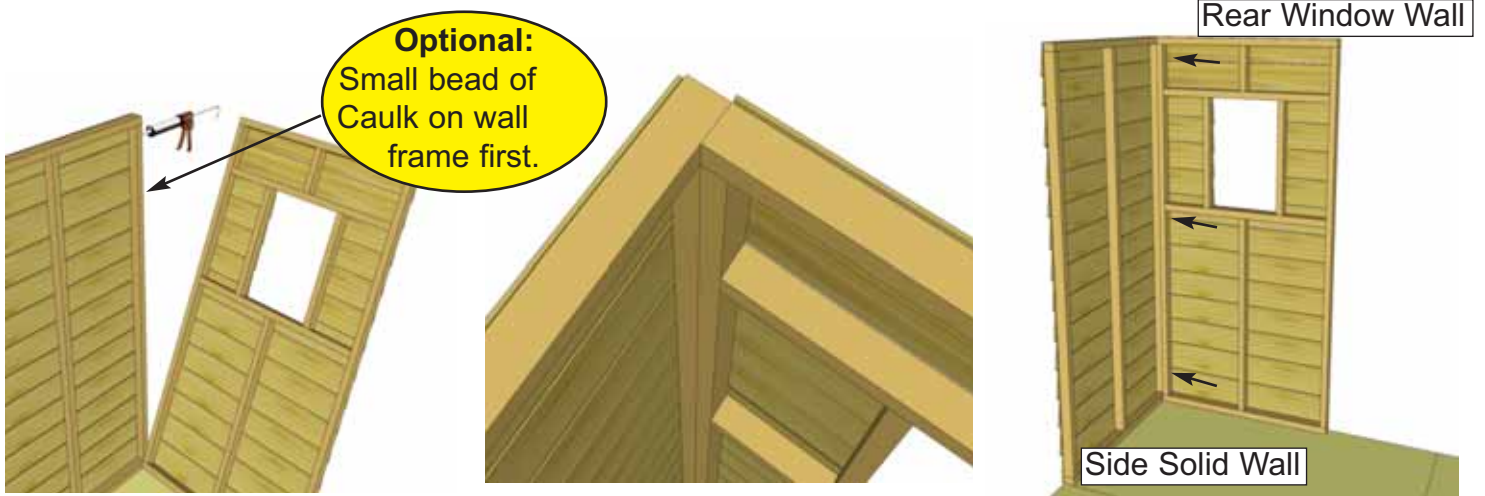

**14.** Position rear **Window Wall Panel** into place on plywood floor. Butt both vertical wall studs of side and rear walls together and attach with **3 - 2 1/2" screws**. Screw at the bottom, middle and top of stud to secure properly.

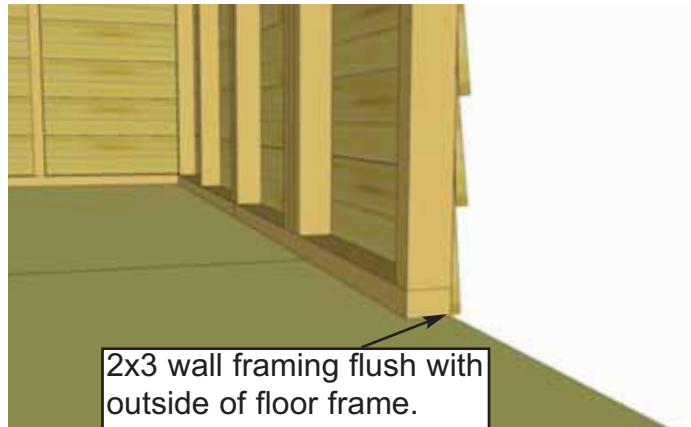

**15.** With the corner wall attachment complete, position a Rear **Solid Wall Panel With Extra Vertical Studs** so bottom 2x3 wall framing is sitting flush with outside floor frame. Wall siding should overhang floor by approximately 3/4". Attach rear wall panel studs together as per **Step 14**.

**16.** Position the final Rear Panel on the floor (**Window Wall Panel**). Position vertical wall studs together and attach as per **Step 14**.



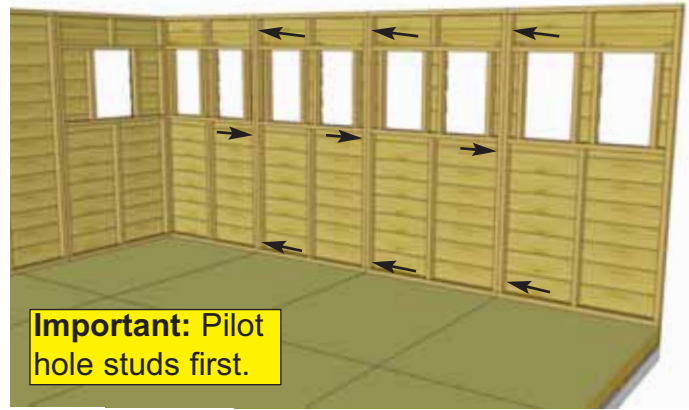
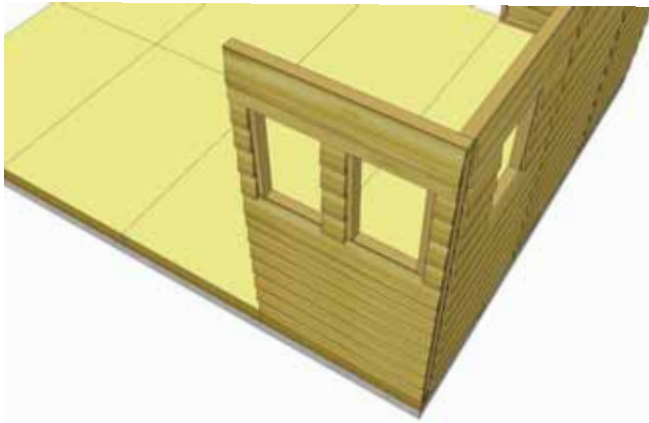

**17.** Attach a **Double Window Wall Panel** in corner. Attach as per **Step 14**. Start positioning and securing remaining **Double Window Walls**. Attach wall studs together as per **Step 14**.



**18.** Complete attachment of left side **Solid Wall Panels**. At the front of the shed, side walls will sit flush with front floor framing.

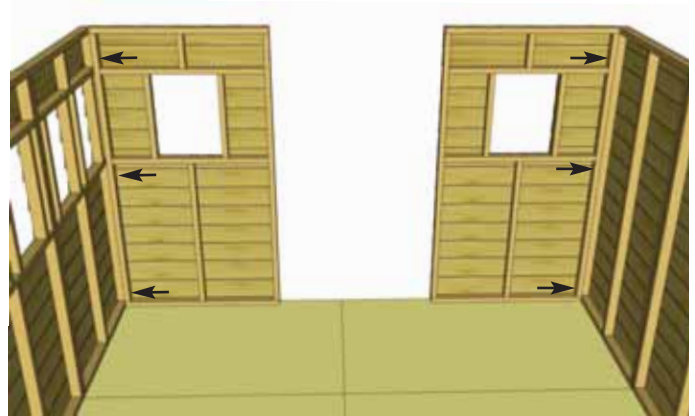

**19.** Secure remaining two **Window Walls** to both front corners of shed.

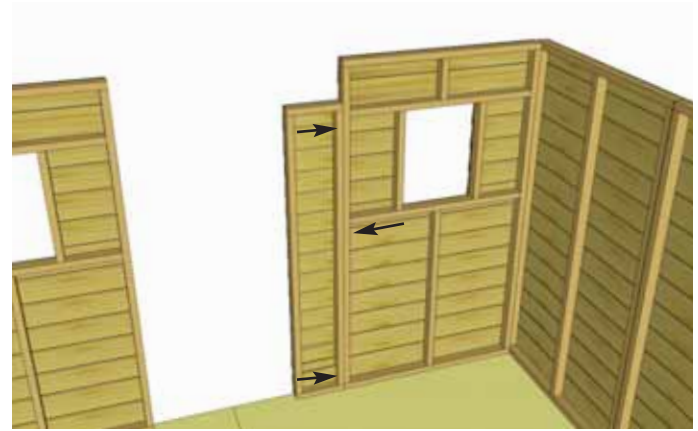

**20.** Lineup **Narrow Wall** so flush with each other on the outside. Attach Studs together with **3 - 2 1/2" screws** as per **Step 14**. **Note:** Narrow Wall is 73" high (9" shorter than other walls).

Parts (Step 20)  
**Narrow Wall Panel**  
(12" x 73") x 1

Hardware (Step 20)  
**S1 - 2 1/2" Screws**  
x 3 total

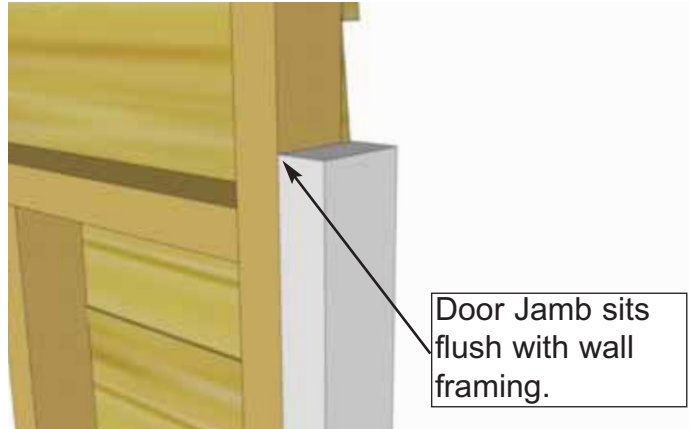

**21.** Locate **Vertical Door Jamb** and position flush against right wall panel stud. The Jamb is 3 1/2" wide and will sit flush to outside of wall siding. When positioned correctly, secure Jamb using **4 - 2 1/2" screws**.

Part (Step 21)  
**Vertical Door Jamb**  
(1 1/2" x 3 1/2" x 73")  
x 1

Hardware (Step 21)  
**S1 - 2 1/2" Screws**  
x 4 total

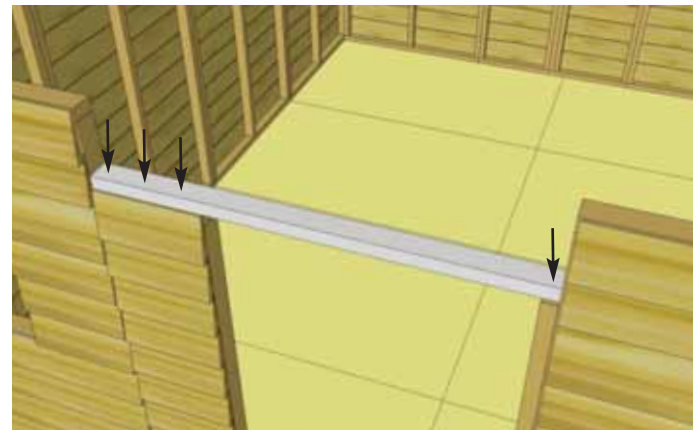

**22.** Position and attach **Door Header Riser** to **Door Jamb** and **Narrow Wall Panel** top framing. Header should fit flush with **Door Jamb** and Outside of **Narrow Wall** Siding. Attach with 4 - 2 1/2" screws.

Part (Step 22)  
**Door Header Riser**  
(1 1/2" x 2 1/2" x 45 1/2")  
x 1

Hardware (Step 22)  
**S1 - 2 1/2" Screws**  
x 4 total



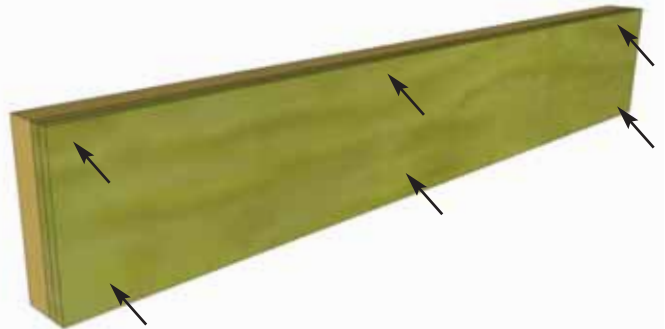

**23.** Locate **Door Header** and **Door Header Spacers**. Lineup three pieces together so they are flush to create a larger piece, attach with **6 - 2" screws**.

Part (Step 23 - 24)  
**Door Header**  
 (1 1/2" x 7 1/4" x 45 1/2") x 1  
**Door Header Spacer**  
 (1/2" x 7 1/4" x 45 1/2") x 2

Hardware (Step 23 - 24)  
**S3 - 2" Screws**  
 x 13 total

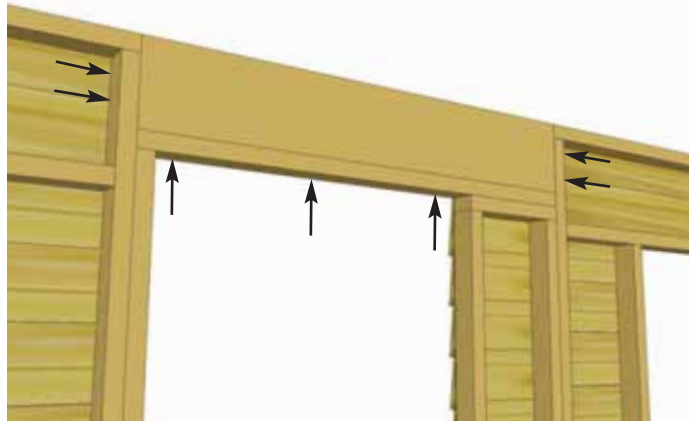

**24.** Place assembled **Door Header** onto **Door Header Riser** and attach with **7 - 2" screws**.

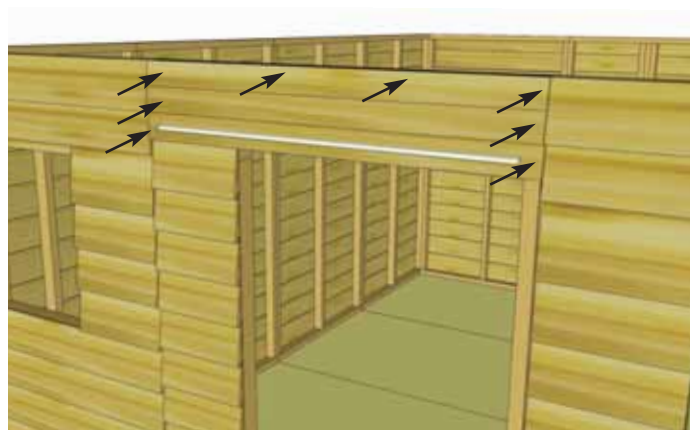

**25.** Locate **Drip Edge with Bevel Siding** attached. Attach to **Door Header Spacer** with **8 - 1 1/2" Finishing Nails**.

Part (Step 25)  
**Drip Edge w/ Bevel Siding**  
 (45 5/8") x 1

Hardware (Step 25)  
**N1 - 1 1/2" Finishing Nail**  
 x 8 total

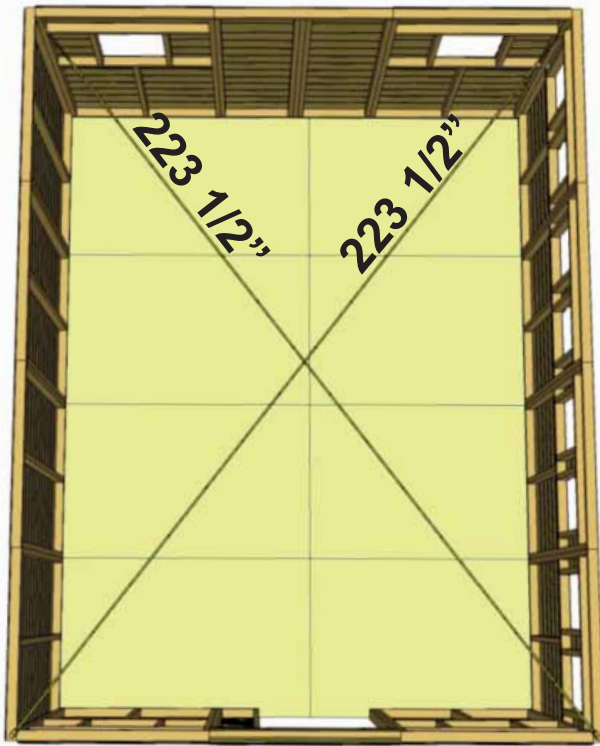

**Advice:** Prior to fastening walls and installing rafters, take time to confirm your walls are level, square and plumb.

Measure diagonal at top and bottom of walls corner-to-corner. This should be approximately 223 1/2". More importantly, if measurements are not within 1/4", your walls are not square. Adjusting now will make it easier to the roof section later.

**Important:** If walls are not lining up and appear higher or lower than each other, please check the level of your floor. You may need to make slight adjustments before proceeding.

**26.** When all walls are attached together, check alignment with the floor. Bottom wall framing should sit flush with outside of floor joists. When positioned correctly, fasten bottom wall plates to floor using **4 - 2 1/2" screws** per wall panel (54 total). **Confirm 32" wide door opening at bottom.**

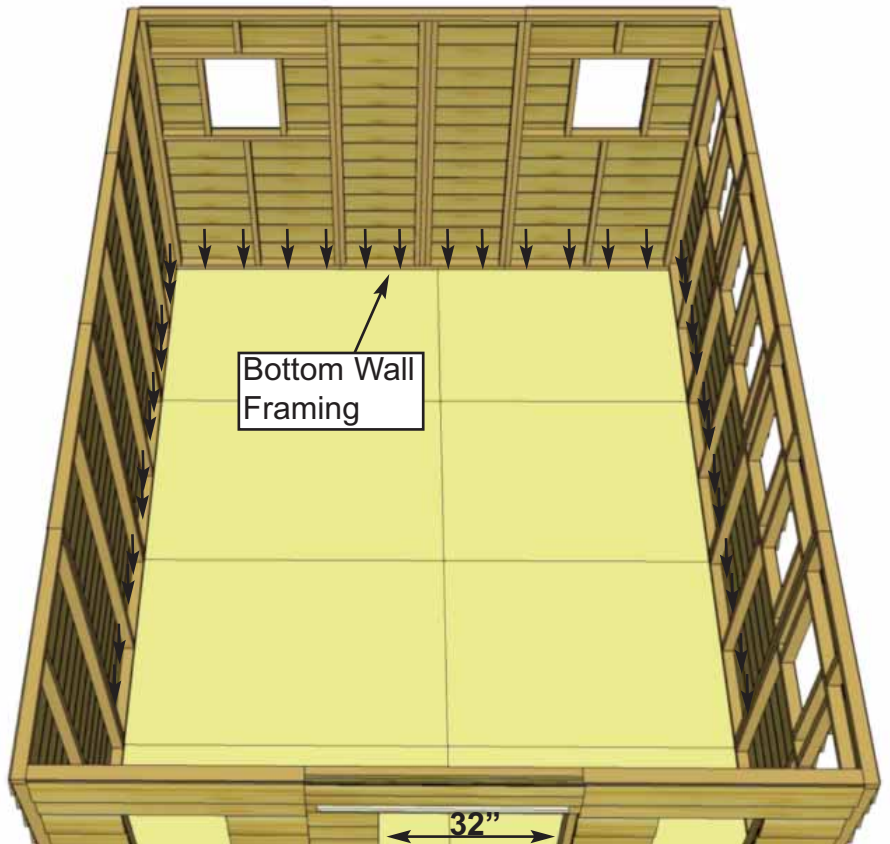

Angle screws into perimeter Floor Joists.

**Optional:** Caulking seams will help prevent moisture from entering your shed. Caulking is included to complete polygal Windows only. Additional Caulking may be required.

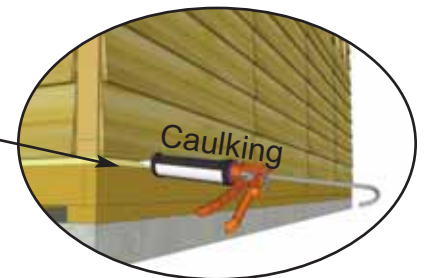

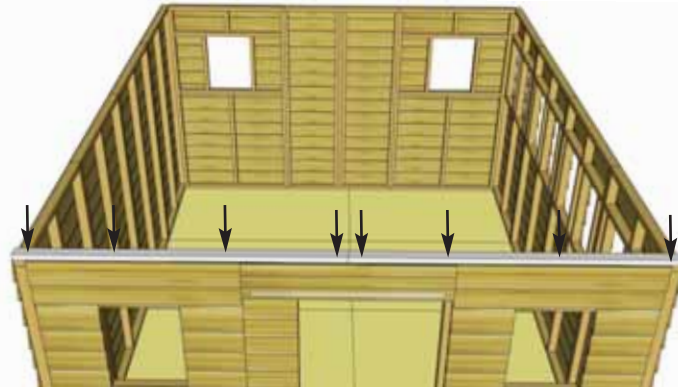
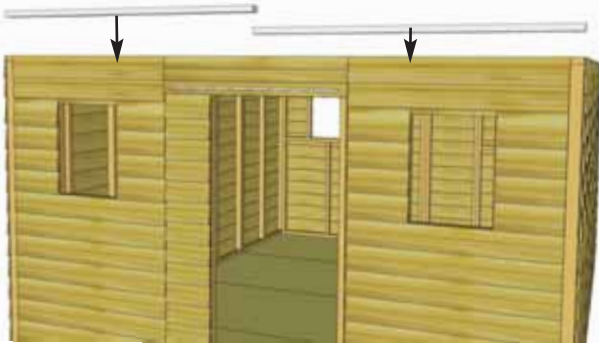

**27.** Position and attach **F & R Riser Plates** on top of Front and Rear **Wall Frames**. attach with **4 - 2 1/2" screws** each. Complete both front and rear of shed.

Parts (Steps 27)  
**F&R Riser Plates**  
 (1 1/2" x 2 1/2" x 70 3/4")  
**x 4**

Hardware (Steps 27)  
**S1 - 2 1/2" Screws**  
 x 16 total

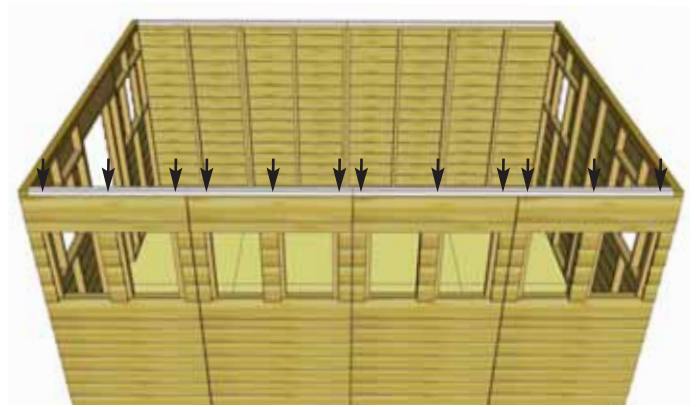
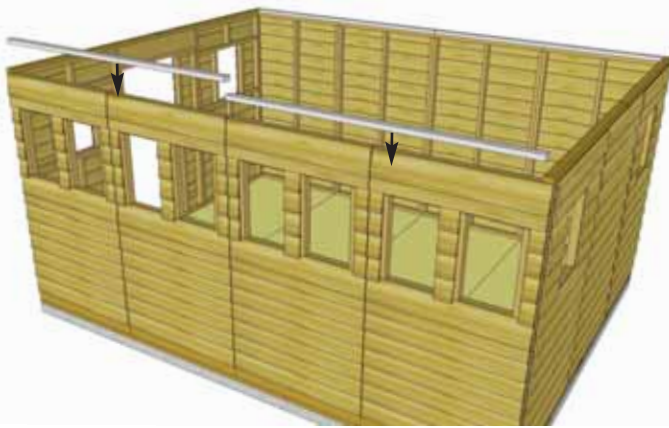

**28.** Position and attach **Side Riser Plates** with **6 - 2" screws** per piece. Complete both sides of shed.

Parts (Steps 28)  
**Side Riser Plates**  
 (1 1/2" x 2 1/2" x 88 1/2")  
**x 4**

Hardware (Steps 28)  
**S3 - 2" Screws**  
 x 24 total

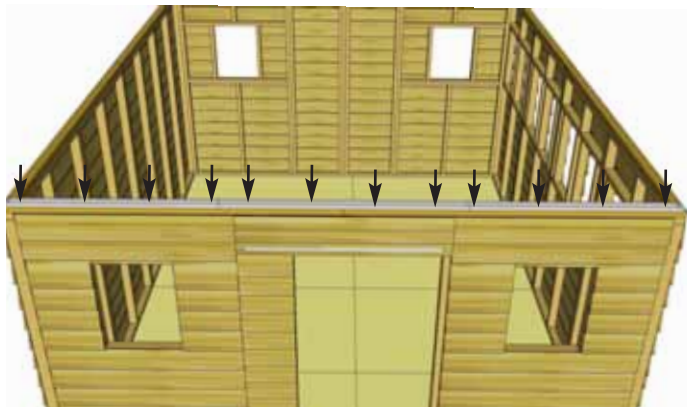

**29.** Position and attach **Front & Rear Top Plates**. There are two pieces with angle cut ends and one straight piece per side. Attach with **4 - 1 1/4" screws** per piece. Complete Front and Rear

Parts (Steps 29)  
**F&R Top Plates Angle**  
 (3/4" x 2 1/2" x 45") **x 4**  
**F&R Top Plates Straight**  
 (3/4" x 2 1/2" x 51 1/2") **x 2**

Hardware (Steps 29)  
**S2 - 1 1/4" Screws**  
 x 24 total

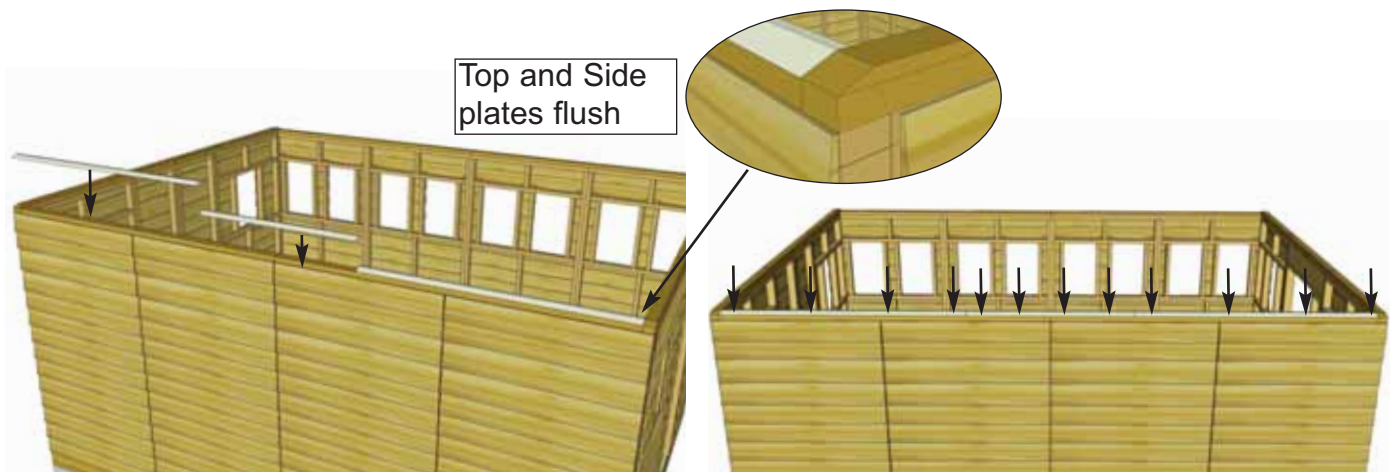

**30.** Position and attach **Side Top Plates** on **Side Riser Plates**. 65 3/4" side plates are on the outside with the 45 1/2" plate in the center. Angle of **Side Plates** should match angle of **F&R Top Wall Plates**. Attach each piece with **4 - 1 1/4" screws**. Complete both sides of shed.

Parts (Steps 30)  
**Side Top Plates**  
 (3/4" x 2 1/2" x 45 1/2") x 2  
 (3/4" x 2 1/2" x 65 3/4") x 4

Hardware (Steps 30)  
**S2 - 1 1/4" Screws**  
 x 24 total



Gable End tucked inside Gable.

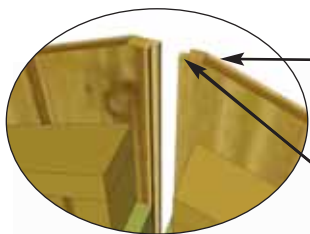

Male / Female Gable Siding Overlap



**31.** Locate Triangular **Gable Half Walls** for both sides of shed. Align framing and wall siding lap together. Screw center wall framing of each piece together with **4 - 2 1/2" screws**. Note: Prior to attaching, try each combination of Gables for best fit. Tip of Gables are separate pieces that need to be attached on in **Step 32**.

Parts (Steps 31-32)  
**Gable Half Walls x 4**

Hardware (Steps 31-32)  
**S1 - 2 1/2" Screws**  
 x 8 total  
**S3 - 2" Screws**  
 x 8 total

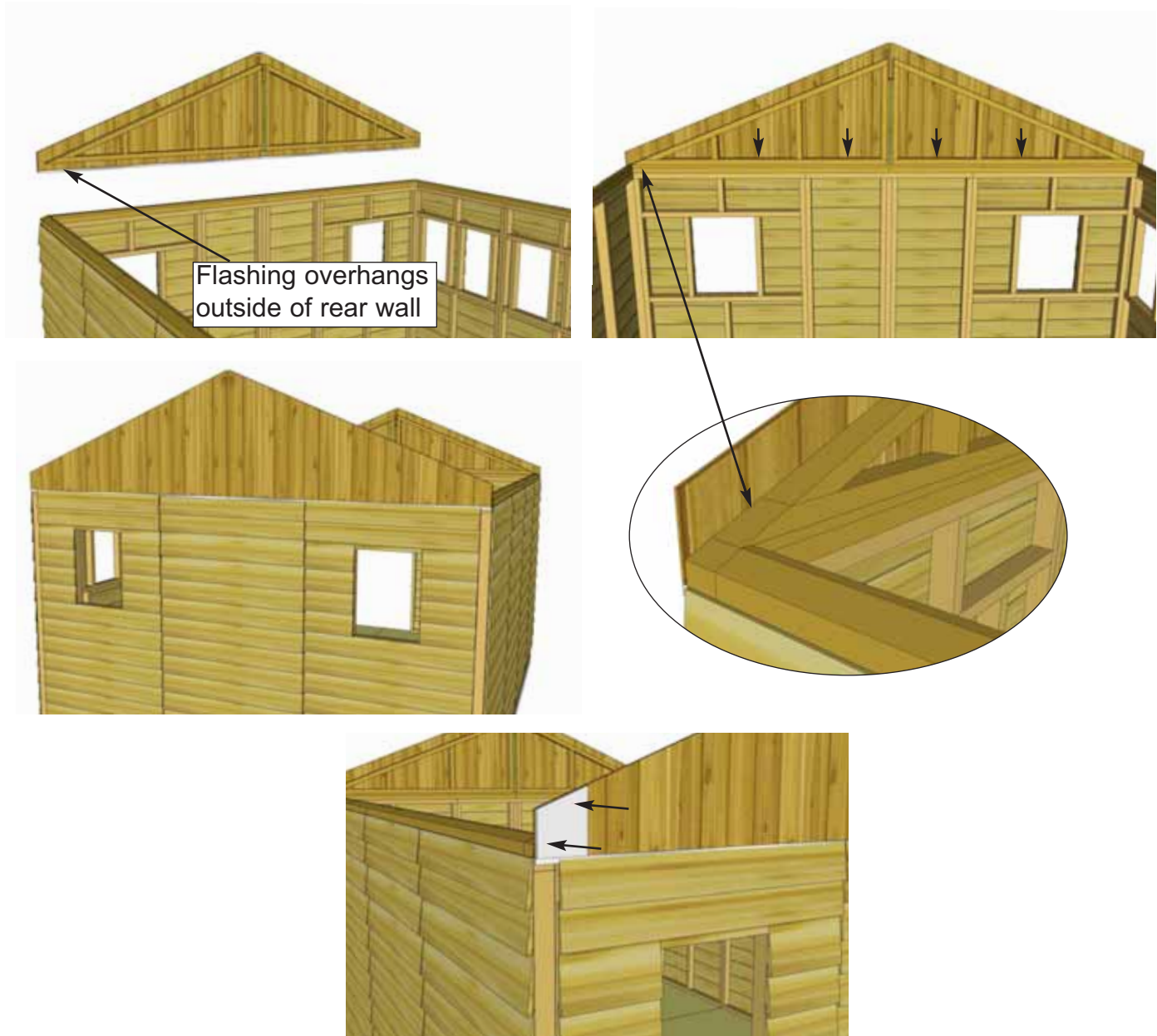

**32.** Place completed **Gable Section** so framing sits flush with the inside of the **Top Wall Plate**. It should also be centered side-to-side on the **Top Wall Plate**. Gable Flashing overhangs wall on the outside. Temporarily attach **Gables** to **Top Wall Plate** with **4 - 2" screws** . Gables may need slight adjustment in **Step 45** when attachment will be completed with an additional 6 screws. Screw from the bottom of **Gable** framing down into **Top Wall Plate** and **Wall Framing**. Complete **Gable** positioning and attachment on the other side. **Hint:** Use a straight edge to check the angle of the Gable framing and Top Plate. Both angles should lineup at 22.5°. Attach Gable tip to shed with **2 - 1 1/2" Finishing Nails** as shown above.

# C. Rafter Section

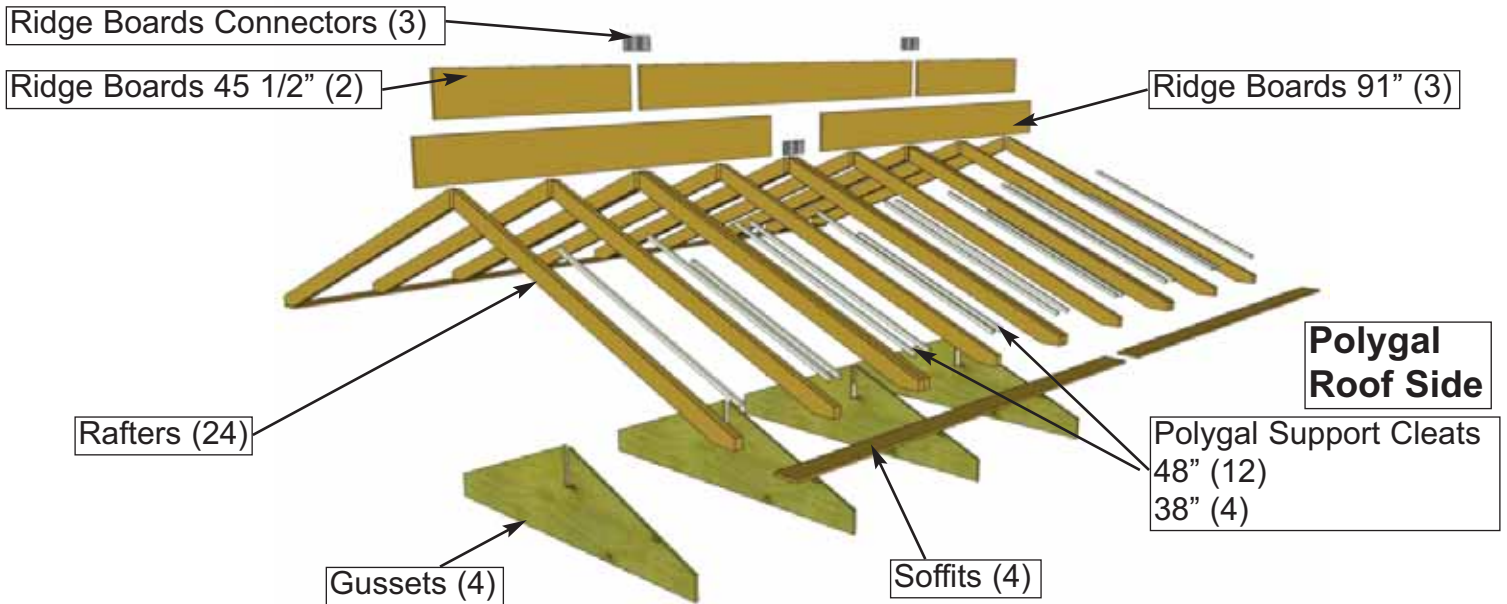

**Important:** Locate all parts necessary to assemble each Rafter Section prior to beginning.

**Parts for One Rafter Section (Polygal Side):**

- 12 - 1 1/2" x 3 1/2" x 80 7/8" - Rafters
- 2 - 3/4" x 9 1/4" x 91" - Ridge Board
- 2 - 1/2" x 4 1/2" x 91" - Soffits
- 12 - 3/4" x 3/4" x 48" - Polygal Support Cleats
- 4 - 3/4" x 3/4" x 38" - Polygal Support Cleats
- \* Must complete 2 Rafter Sections

**Parts for Other Rafter Section (Non-Polygal Side):**

- 12 - 1 1/2" x 3 1/2" x 80 7/8" - Rafters
- 2 - 3/4" x 9 1/4" x 45 1/2" - Ridge Boards
- 1 - 3/4" x 9 1/4" x 91" - Ridge Board
- 2 - 1/2" x 4 1/2" x 68 1/4" - Soffits

**Remaining Rafter Pieces:**

- 4 - 3/4" x 80" x 19 3/4" - Gussets

Follow **Steps 33-49** to Assemble Rafter Sections. Make sure to complete on a flat, level surface.

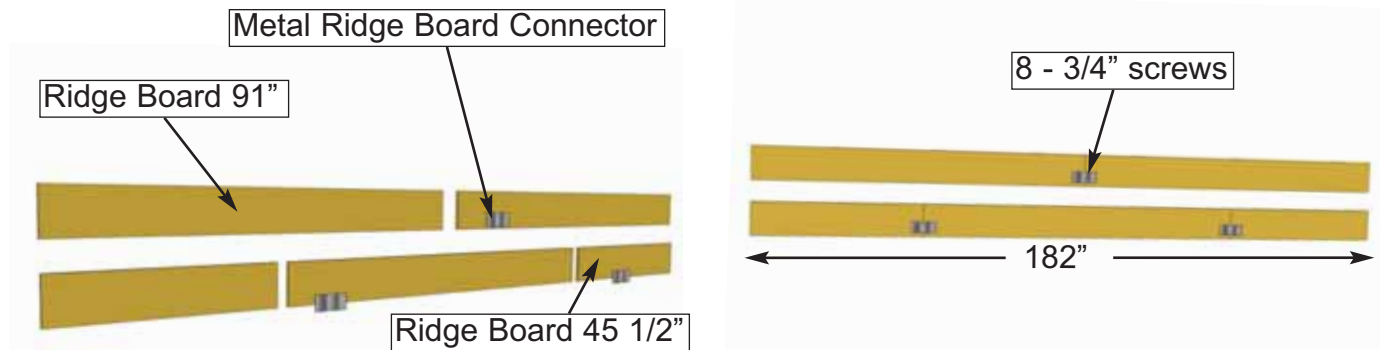

**33.** Locate **Ridge Boards** and attach together using **Metal Ridge Board Connectors** and **8 - 3/4" screws** evenly spaced on boards per connector. Place connector approximately 1 1/4" up from bottom of **Ridge Board**. Total length when connected is 182". Complete two **Ridge Boards**.

**Parts (Steps 33)**  
**Ridge Boards**  
 (3/4" x 9 1/4" x 45 1/2") x 2  
 (3/4" x 9 1/4" x 91") x 3

**Hardware (Steps 33)**  
**SS2 - 3/4" Screws**  
 x 24 total  
**Y9 - Metal Ridge Connector**  
 x3 total

Completed Ridge Board

2 1/2" Screws into Doubled up Rafters

**Important:** Pilot hole Ridge Board to prevent splitting

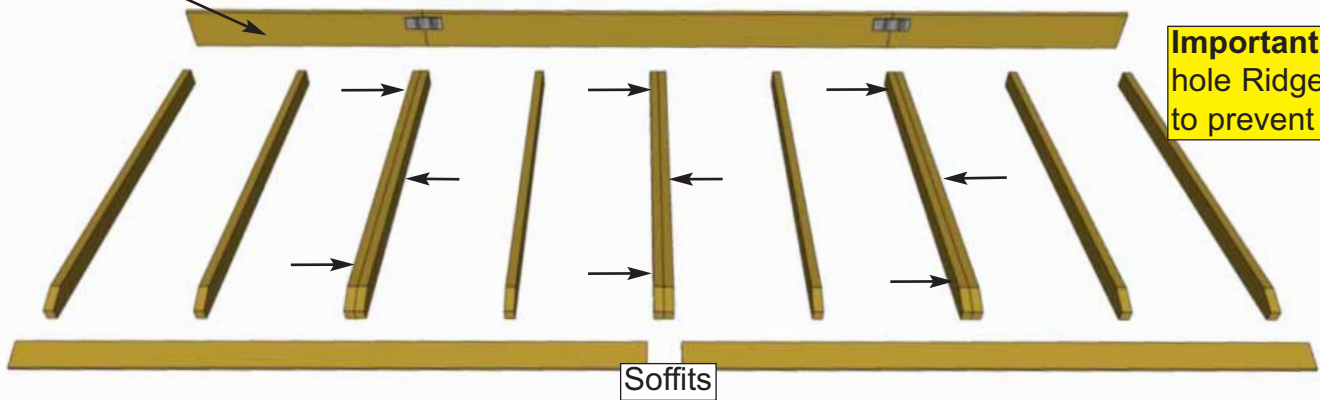

**34.** Lay out 12 Rafters, 2 Soffits and the completed Ridge Board from Step 33 on level ground as shown. Double up Rafters as illustrated. Screw doubled up Rafters together with 3 - 2 1/2" screws. **Note:** completed rafter section will be flipped over in Step 38.

Parts (Steps 34 - 37)

**Ridge Boards**

(3/4" x 9 1/4" x 45 1/2") x 2

(3/4" x 9 1/4" x 91") x 3

**Rafters**

(1 1/2" x 3 1/2" x 80 7/8") x 24

**Soffits**

(1/2" x 4 1/2" x 91") x 4

Hardware (Steps 34 - 37)

**S1 - 2 1/2" Screws**

x 18 total

**S3 - 2" Screws**

x 48 total

**S2 - 1 1/4" Screws**

x 48 total

Completed Ridge Board

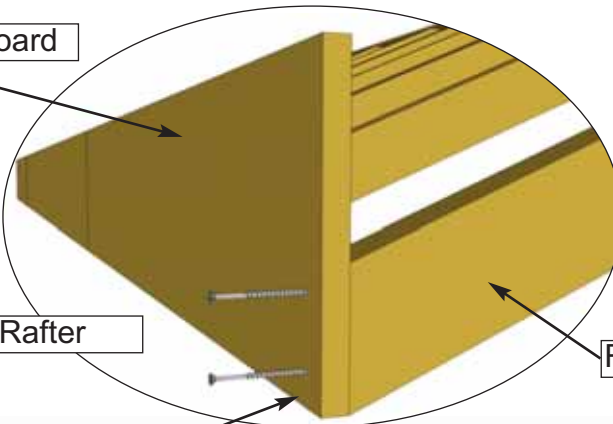

2 - 2" Screws / Rafter

Rafter

**Important:** Measure 20 1/2" spacing accurately to accommodate Polygal Panels. See Step 66.

**Expert Advice:** Use Polygal Panel to confirm correct width

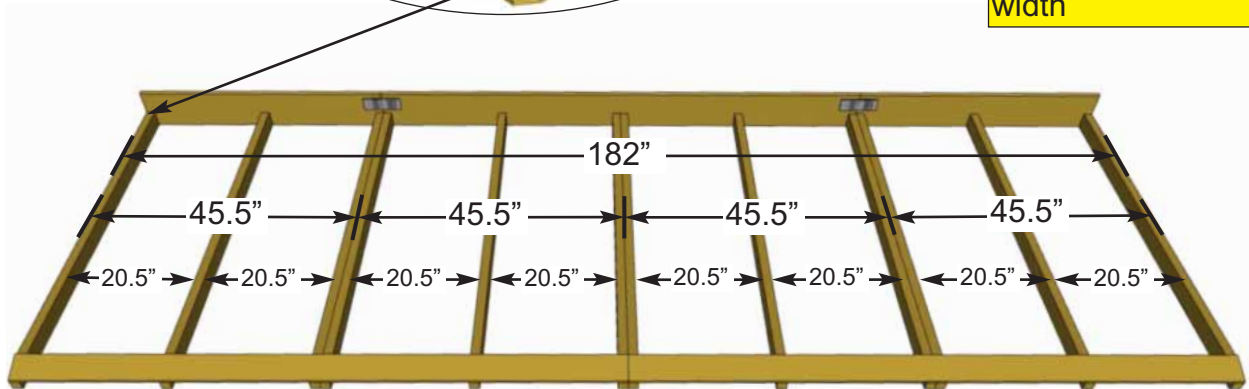

**35.** Attach completed Ridge Board to ends of both outside Rafters with 2 - 2" screws per end. Measure and position interior Rafters as illustrated above. When positioned correctly, attach Ridge Board to remaining Rafters with 2 - 2" screws per rafter end. **Important:** Pilot Hole Ridge Board to prevent splitting.

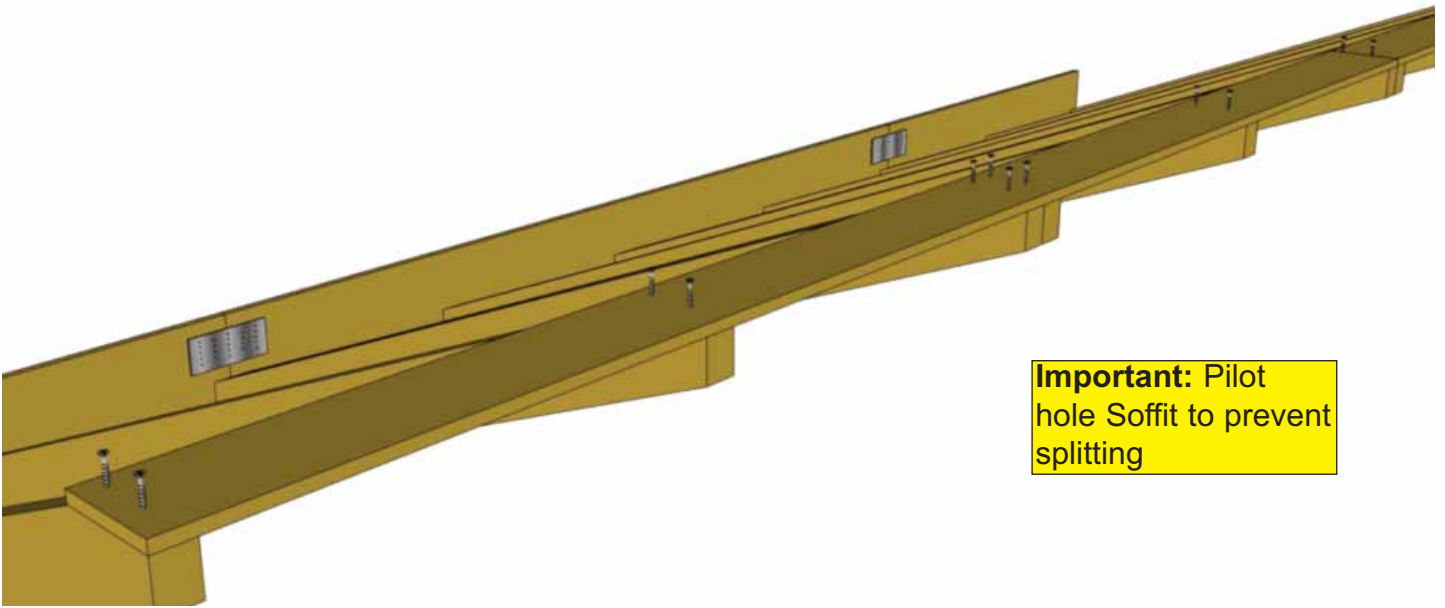

**36.** Attach end **Soffit** Board flush to ends of outside **Rafters** with 2 - 1 1/4" screws per **Rafter** end. Complete both outside **Rafter/Soffit** connections first. Measure and position interior **Rafters** as illustrated above. When positioned correctly, attach **Soffits** to remaining **Rafters** with 2 - 1 1/4" screws/rafter. **Important:** Pilot Hole **Soffits** to prevent splitting.

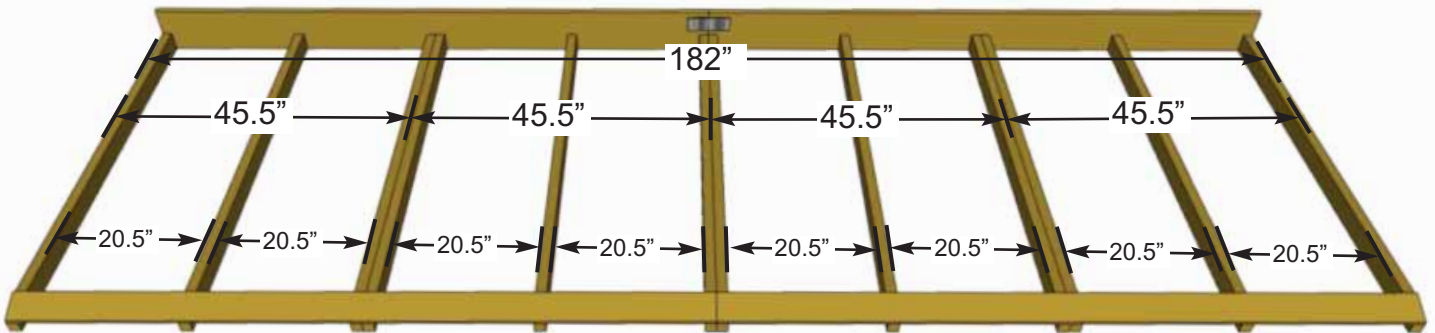

**37.** Complete second **Rafter** section following **Steps 34 - 36**.



**38.** With some helpers flip over each **Rafter** section so they can be lifted onto the shed. **Soffits** should now be on the ground. Prepare to lift onto Wall and **Gable Frame**



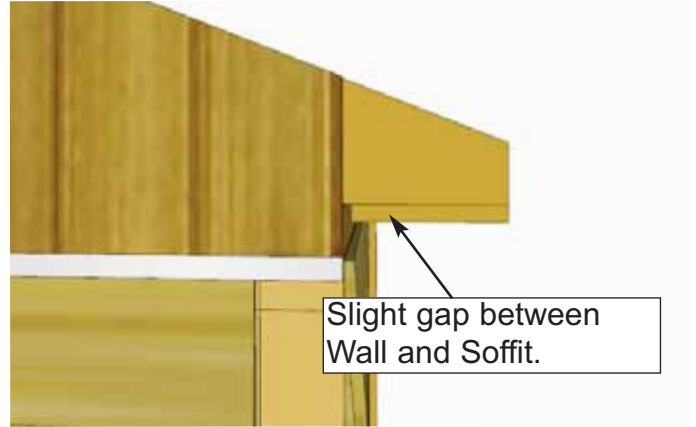
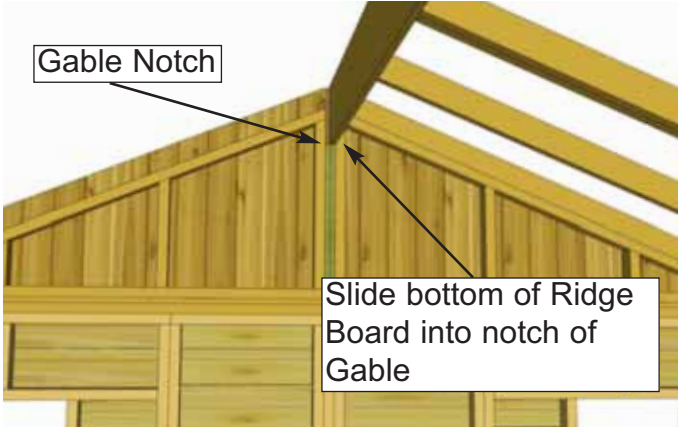
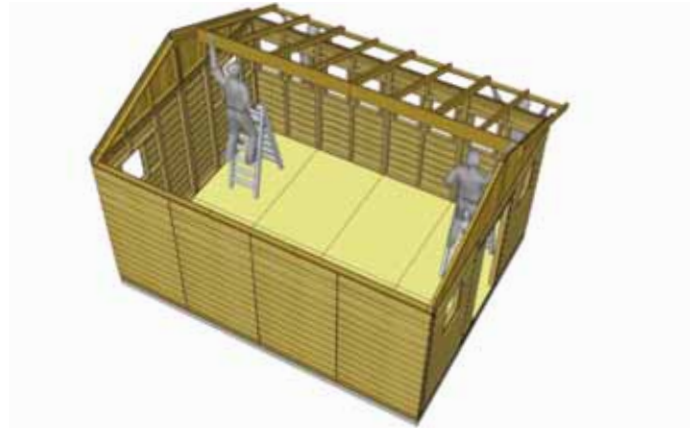

**39.** With the assistance of two or more helpers and some ladders, slide first **Rafter Section** up onto **Gable Framing** until bottom of **Ridge Board** slips into gable notch. Position **Rafters** so they sit evenly on **Gable Framing** from side to side. Where **Wall** and **Soffit** meet, a small gap may appear. Confirm all **Rafters** are resting on **Top Plate**.

Ensure Ridge Boards are flush with one another.

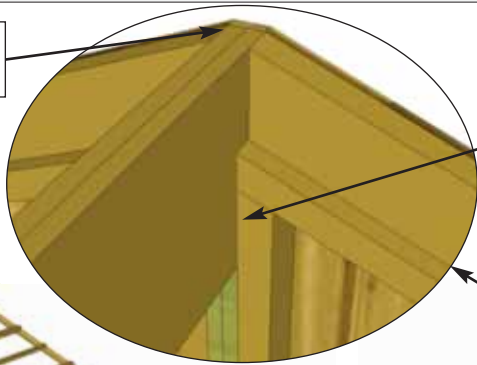

Bottom of Ridge Board fits in gable notch.

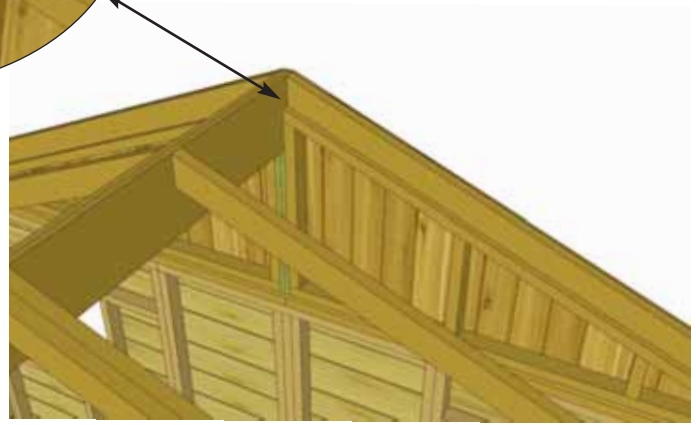

**40.** Lift second **Rafter Section** up and place on **Gable Framing**. Slide **Rafter Section** up on framing until bottom of **Ridge Board** slips into Gable notch. **Soffit** will sit approximately 1/8" away from wall as per **Step 39**.

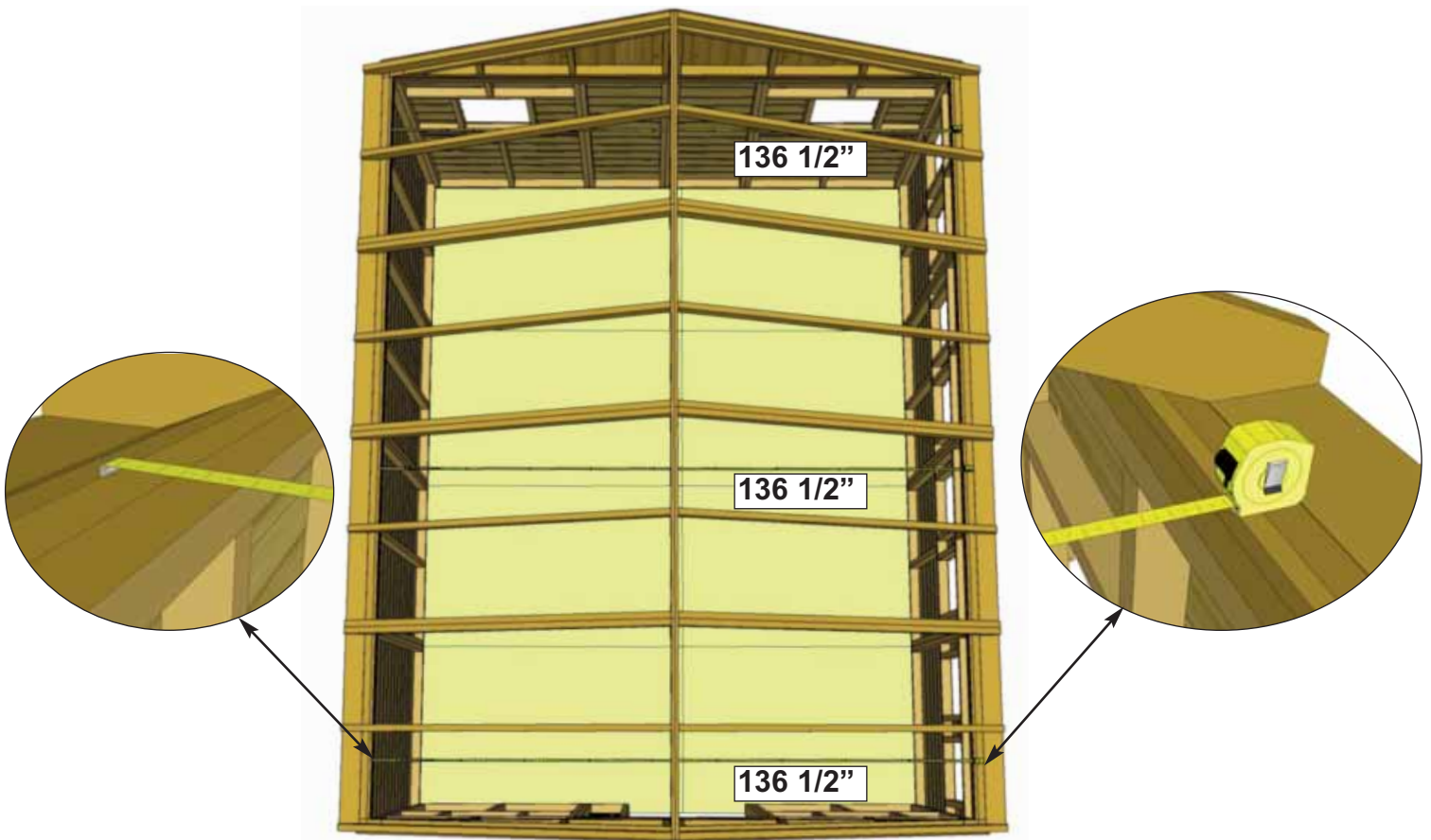

**41.** Take the inside-to-inside measurement between **Top Wall Plates** and **Bottom Wall Plates** at the front, middle, and rear of your shed. These measurements should each be approximately 136 1/2", but more importantly, if they are not within 1/4" of each other, your walls are not square.

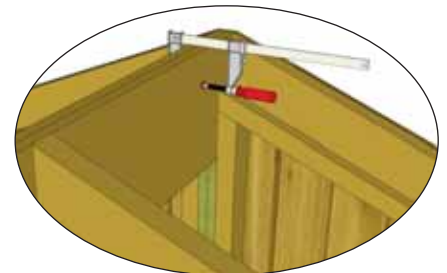

**Advice:** It may be helpful to use a clamp to help hold Ridge Boards together flush while screwing.

**44.** Where **Ridge Boards** meet, press together and secure with **16 - 1 1/4" screws** per side. We recommend using a clamp to hold the **Ridge Boards** together flush while screwing. Stagger screw position vertically on **Ridge Board** to create a stronger connection. Complete both sides, Important: if there is a gap between **Ridge Boards**, try pushing side walls closer together from outside. Walls should be 136 1/2" apart at top from inside of wall plate to wall plate as per **Step 41**.

**Hardware (Steps 44)**  
**S2 - 1 1/4" Screws**  
 x 32 total



**Important:** If Gable framing does not line up with Rafters, remove temporary 2" screws from Gable framing. Re align gable and then secure.

**45.** With both **Rafter Sections** correctly aligned, secure **Gable Framing** to both outside **Rafters** with **8 - 2" screws** per side at top and with **8 - 2" screws** into **Top Wall Plates** at bottom.

Hardware (Steps 45)  
**S3 - 2" Screws**  
 x 32 total

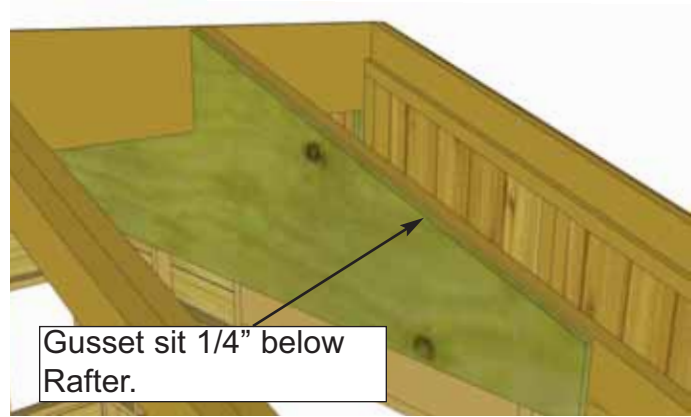

**46.** Start by attaching one **Gusset** onto the middle **Rafters** as illustrated. Attach only **1 - 2" screw** per side now. **Important:** Pilot hole **Gussets** to prevent splitting.

Parts (Steps 46 - 47)  
**Gussets**  
 (3/4" x 80" x 19 3/4") x 4

Hardware (Steps 46-47)  
**S3 - 2" Screws**  
 x 40 total

**Important:** Before attaching remaining Gussets, recheck the inside-to-inside wall measurements are done as in **Step 41**. Use a level to check they are square.

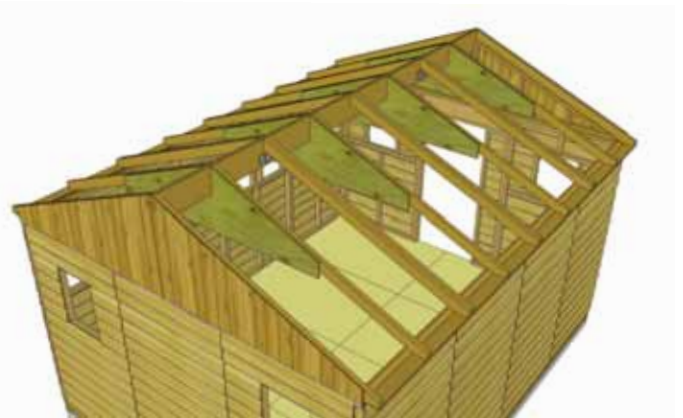

**47.** Once walls are confirmed to be square and plumb, attach the remaining 3 **Gussets** with **10 - 2" screws** per **Gusset**. **Gussets** attach to single **Rafters**. Attach remaining screws to **Gusset** that was attached in **Step 46**. **Important:** Pilot hole ends of **Gusset** to prevent splitting.

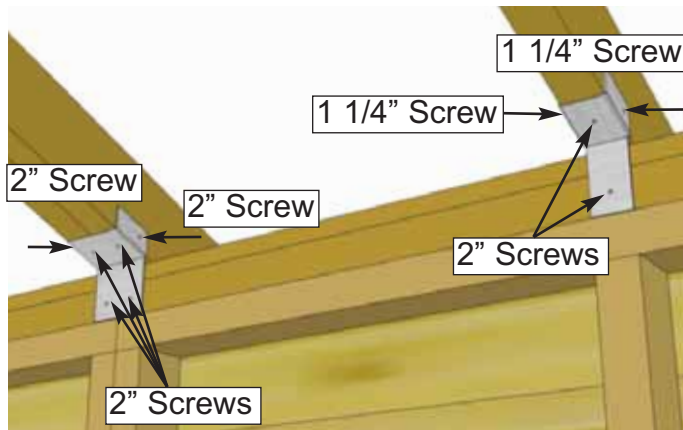

**48.** Attach all Single and Double **Rafter Brackets** where **Rafters** meet **Top Wall Plates** inside of shed. Attach with **2 - 1 1/4" screws** and **2 - 2" screws** per Single **Rafter Bracket** and **6 - 2" screws** per Double **Rafter Bracket**.

Hardware (Steps 48)

**Y30 - Single Rafter Bracket**  
x 8 total

**Y31 - Double Rafter Bracket**  
x 6 total

**S2 - 1 1/4" Screws**  
x 16 total

**S3 - 2" Screws**  
x 52 total

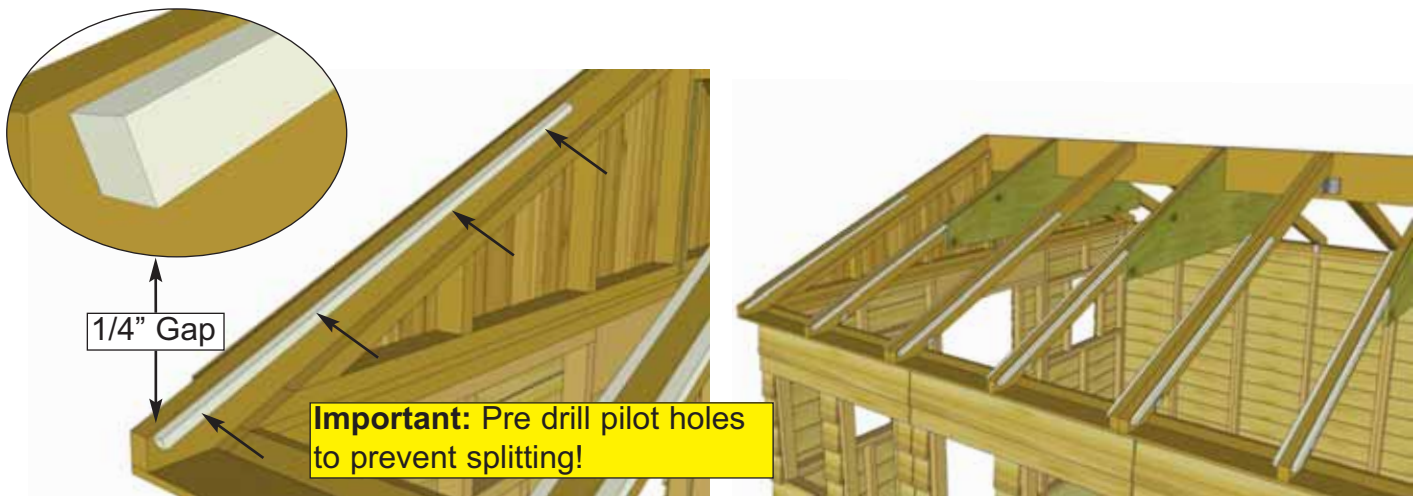

**49.** Position **Polygal Support Cleats** alongside **Rafters**. Leave a 1/4" gap down from top of **Rafter**. The shorter Cleat is for the **Rafters** with a **Gusset** attached. Secure each Cleat to **Rafter** with **4 - 1 1/4" screws**. Ensure to pre-drill pilot holes to avoid splitting Complete remaining **Polygal Support Cleats**.

Parts (Step 49)  
**Polygal Support Cleats Short**  
 (3/4" x 3/4" x 38") x 4  
**Polygal Support Cleats Long**  
 (3/4" x 3/4" x 48") x 12

Hardware (Step 49)  
**S2 - 1 1/4" Screws**  
 x 64 total

## D. Roof Section

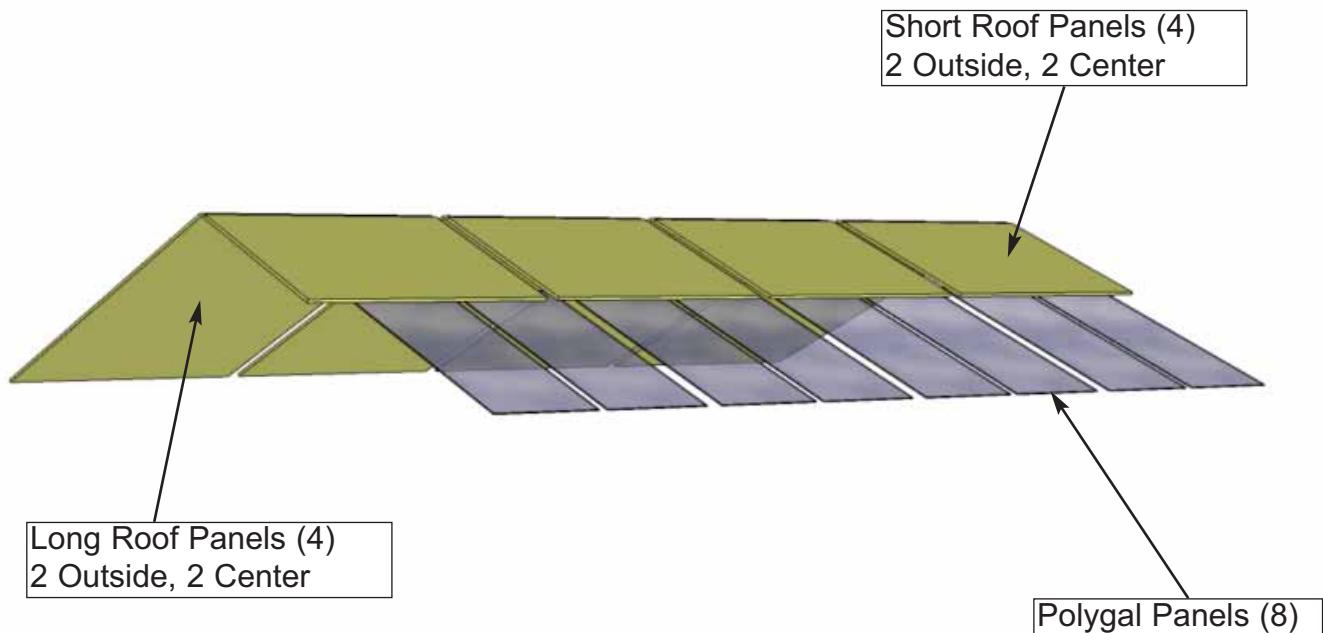

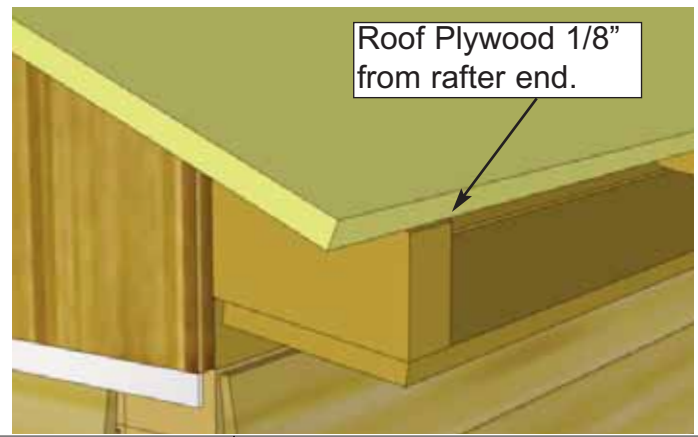
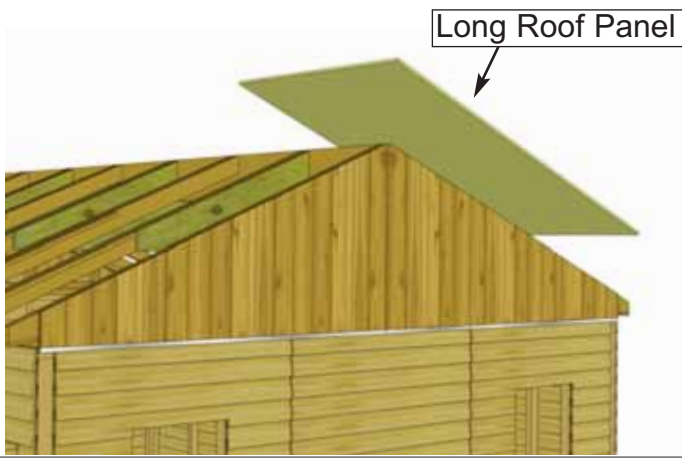

**50.** Identify Roof Panels. There are 4 **Long Roof Panels** and 4 **Short Roof Panels**. Start on the long side of roof (side without polygal support cleats). Lift the long left panel onto roof such that the roof plywood is 1/8" from end of roof rafter..

Parts (Step 50 - 54)  
**Long L&R Roof Panels**  
 (5/8" x 48" x 81 1/2") x 2  
**Long Center Roof Panels**  
 (5/8" x 45 1/2" x 81 1/2") x 2

Hardware (Step 50 - 54)  
**S2 - 1 1/4" Screws**  
 x 36 total

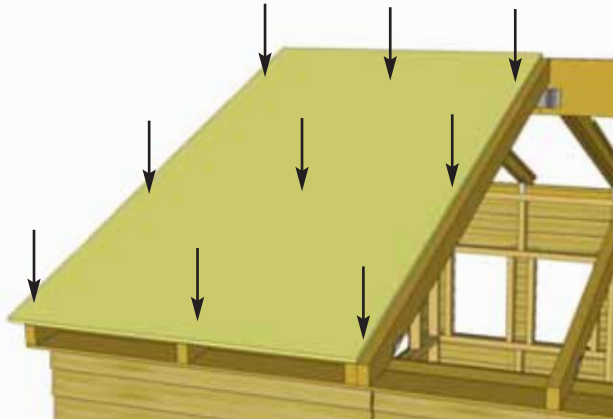

**51.** Position Panel so roof plywood sits evenly on doubled up Rafters. Screw Panel to Rafters with **9 - 1 1/4" screws**. Lift up and place a **Long Center Roof Panel** on Rafters. Position evenly on Rafters.

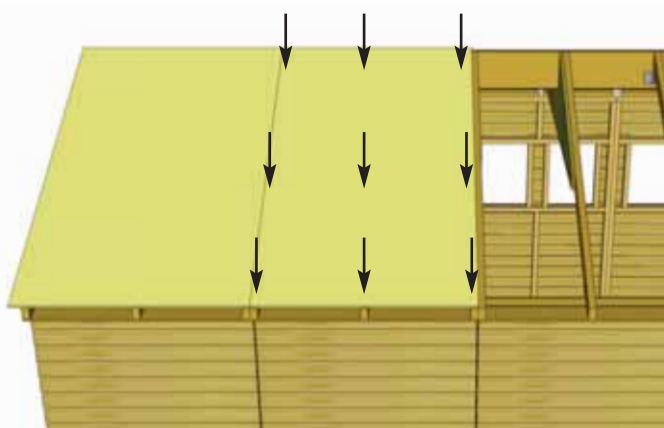

**52.** Position **Center Roof Panel** so plywood is 1/8" from end of Rafters as per **Step 50**. From side-to-side, make sure Roof Panel is sitting equally on rafters. When positioned correctly, screw down with **9 - 1 1/4" screws** into Rafters.

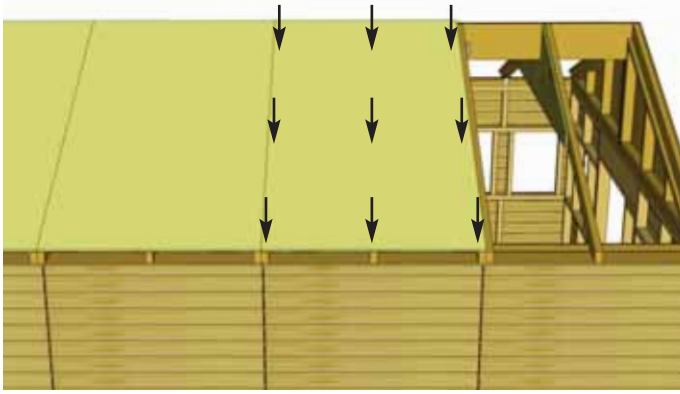

**53.** Locate **2nd Center Roof Panel** and position so plywood is 1/8" from end of Rafters as per **Step 50**. From side-to-side, make sure Roof Panel is sitting equally on rafters. When positioned correctly, screw down with **9 - 1 1/4" screws** into Rafters.

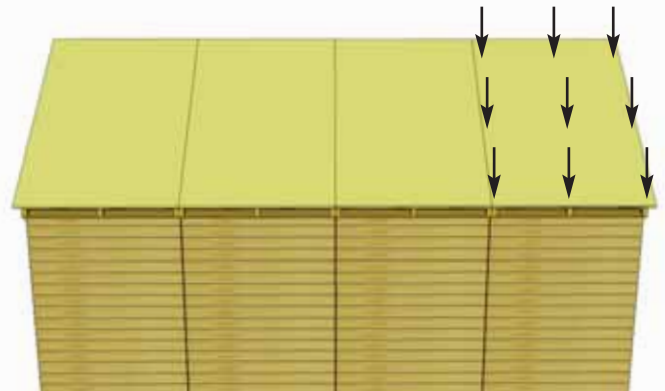

**54.** Lift up and place remaining **Long Outside Roof Panel** on Rafters. With **Outside Roof Panel** centered on rafter and aligned as per **Steps 50 - 51**, screw panel down with **9 - 1 1/4" screws**.

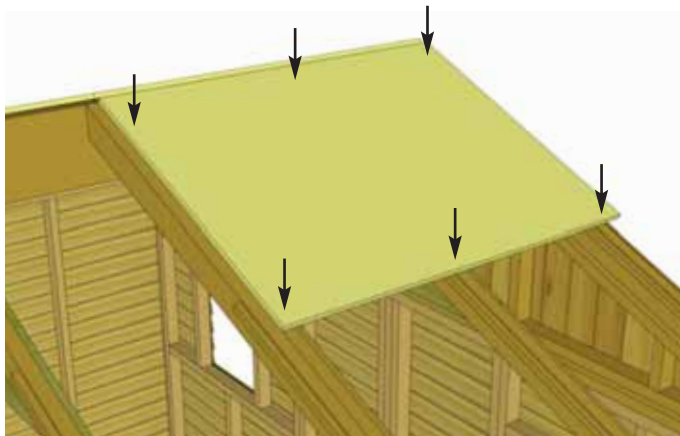

**55.** Locate **Short Right Roof Panel**. Lift and place panel on polygal side of roof. Position **Short Right Roof Panel** equally on seam of doubled up Rafter as per **Step 51**. Align Roof Panel at top so even with long panel at peak. Reach through opening in Rafters to attach. When positioned correctly, screw down with **6 - 1 1/4" screws** into Rafters as illustrated above. **Hint:** work from inside of shed to position and secure Polygal Side Roof Panels.

Parts (Step 55 - 56)  
**Short L&R Roof Panels**  
 (5/8" x 48" x 37 1/2") x 2  
**Short Center Roof Panels**  
 (5/8" x 45 1/2" x 37 1/2") x 2

Hardware (Step 55 - 56)

**S2 - 1 1/4" Screws**  
 x 24 total

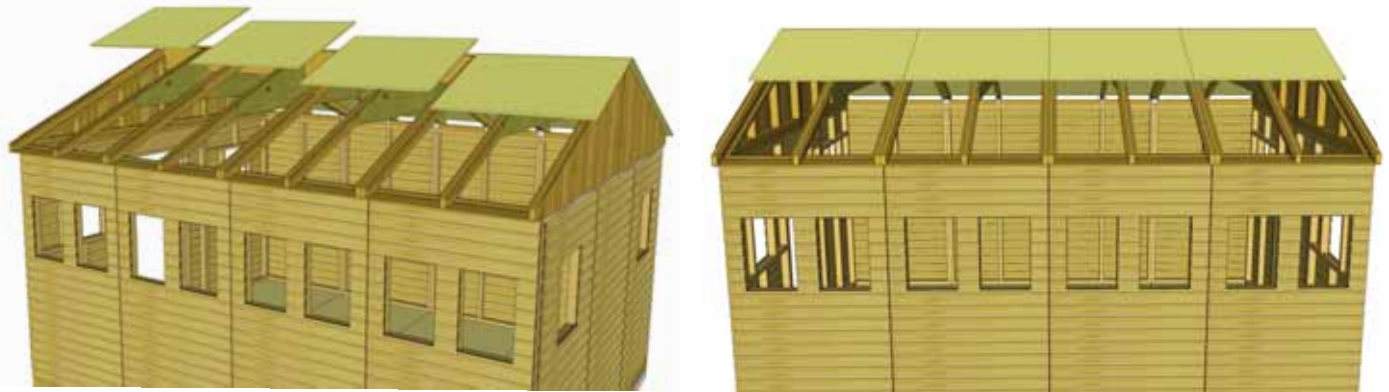

**56.** Repeat **Steps 52 - 54** to attach remaining panels on short roof side. Align evenly at roof peak.

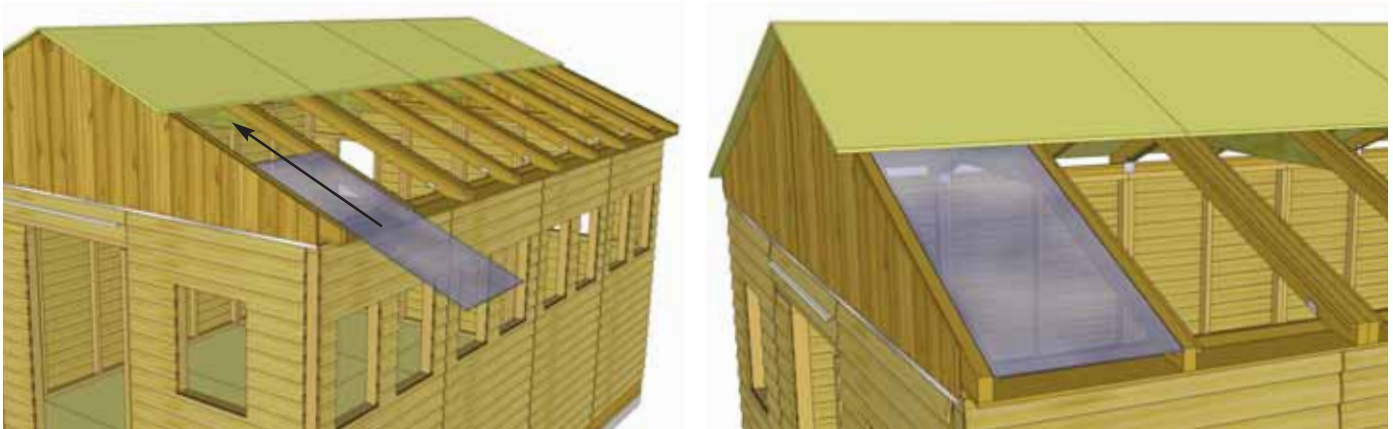

**57.** Installation of 8 **Polygal Panels** is next. Start by removing protective plastic layer from each panel. Exterior/interior side of protective polygal film is printed on film, be sure to note the side and install accordingly. Slide panel up between **Rafters** so it rests on **Polygal Support Cleats**. From the inside, carefully slide end of **Polygal Panel** underneath roof. Position **Polygal Panel** equally between **Rafters**. **Polygal Panel** will overhang end of **Rafter** by 1/2".

Hardware (Steps 57 - 59)

**SS1 - 1" Screws**  
x 72 total

Parts (Steps 57 - 59)

**Polygal Panels**  
(48" long) x 8



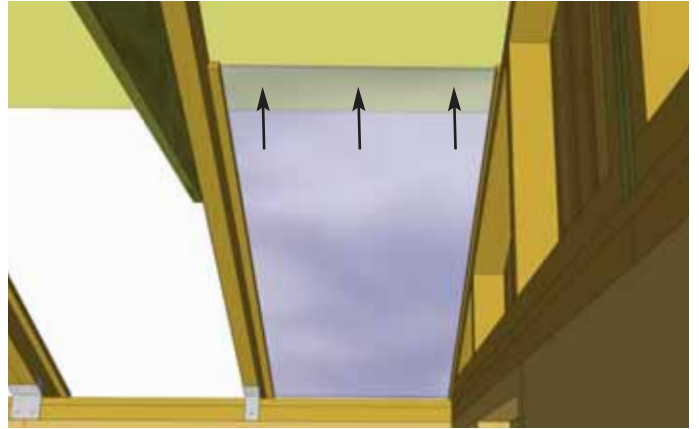
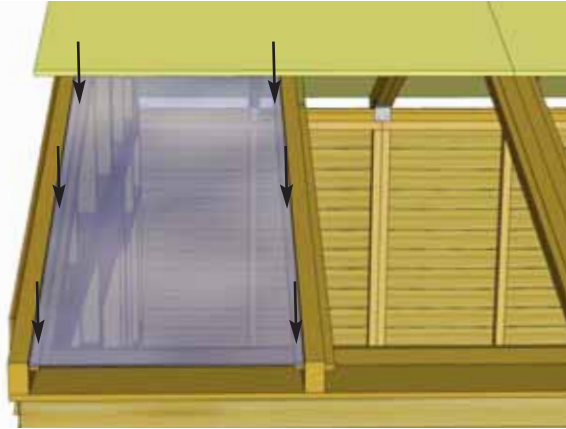

**58.** Drill pilot holes with 1/8" bit through **Polygal Panel** and **Polygal Support Cleats**. Once aligned, with **6 - 1" screws**, secure panel to **Polygal Support Cleats**. Polygal is delicate, tighten screws a half turn at a time so screws are flush with top of **Polygal Panel**. Use **3 - 3/4" screws** to secure **Polygal Panel** to underside of Roof Plywood.

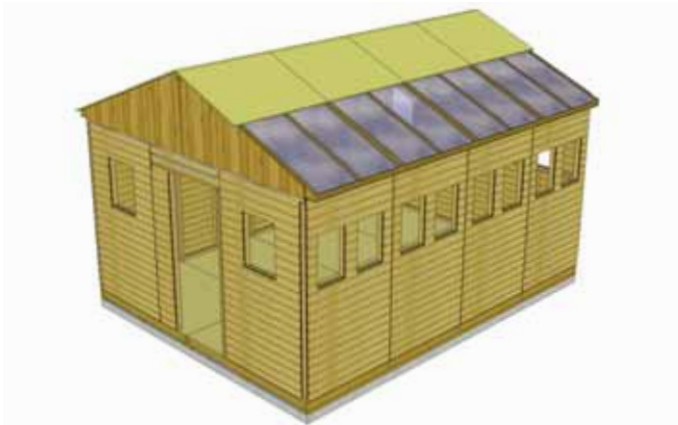

**59.** Position and secure remaining **Polygal Panels** as per **Steps 57 - 58**. With a caulking gun, apply silicone to seal gaps between **Rafters** and **Polygal Panels**. Apply silicone down each side of **Rafter**. Use liberal amounts to properly seal.

# E. Miscellaneous Section

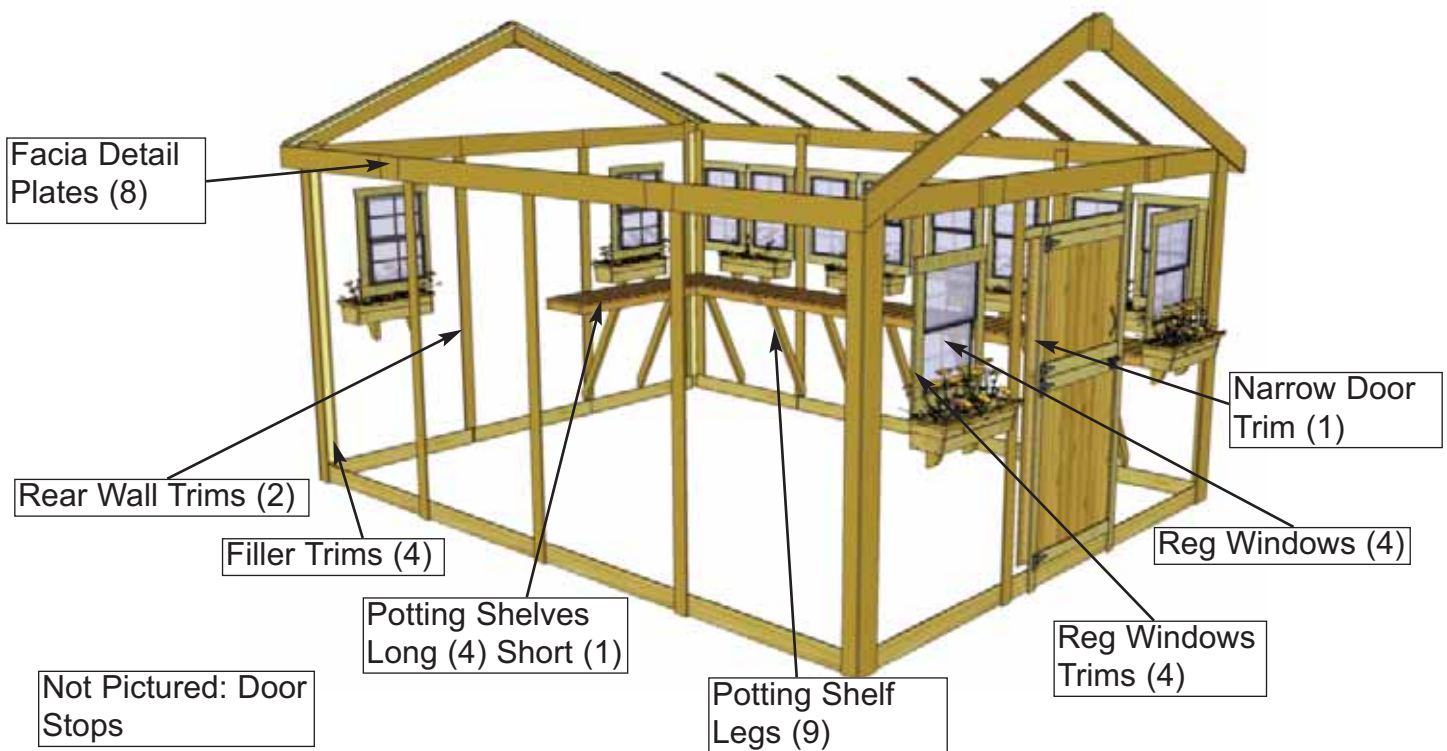
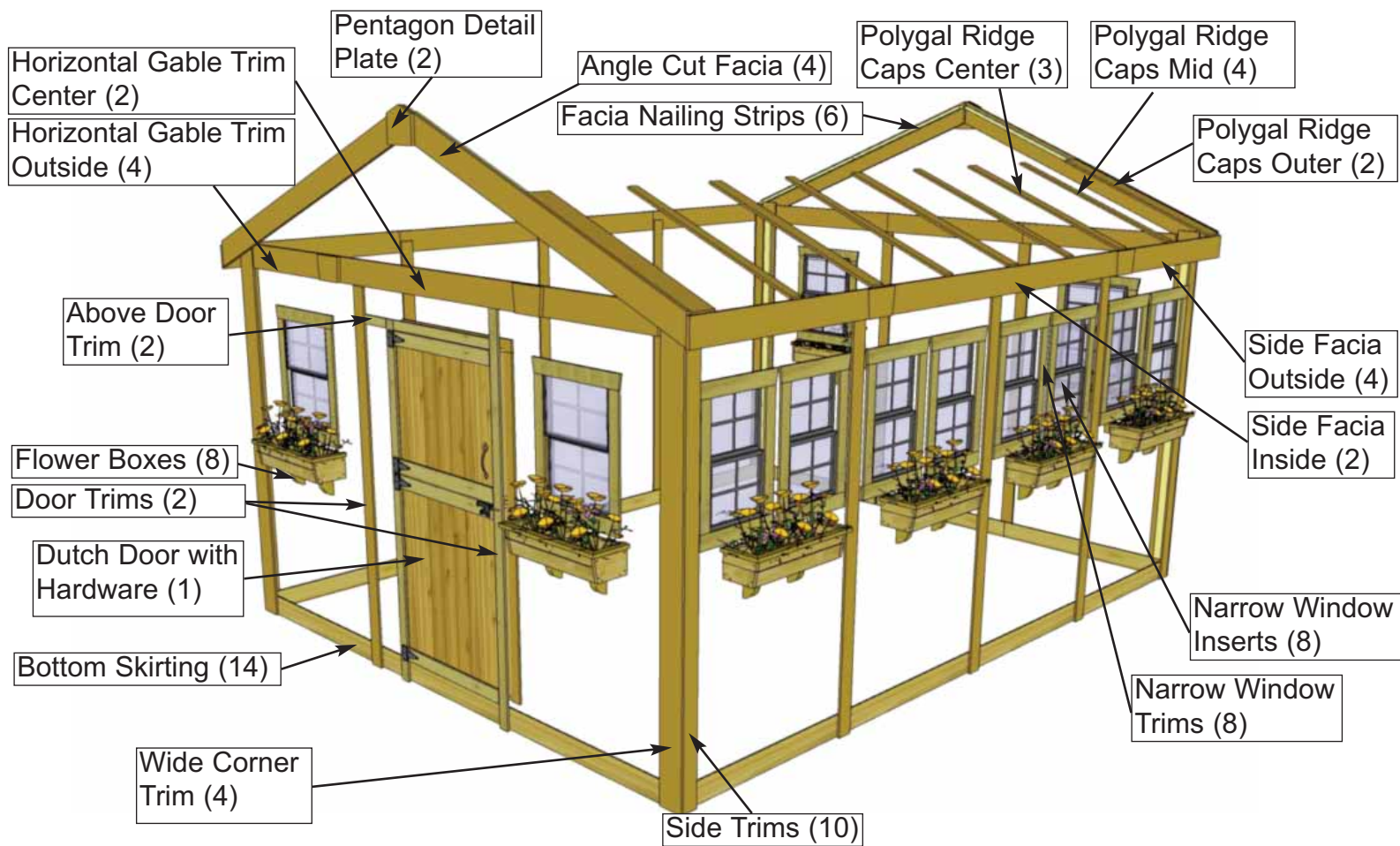

**Expert Advice:** When installing trim, sort pieces according to color and pieces that are most pleasing to the eye. Start with least visible side and use the least desirable pieces first. Install trim to most visible sides as your skill installing trim improves.

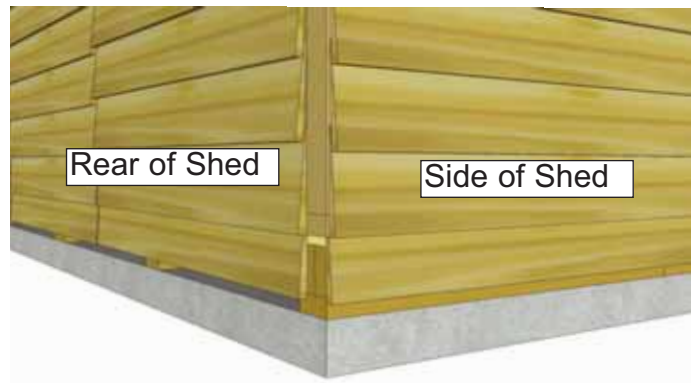

**60.** Attach **Bottom Skirting - Bevel** around the base of the shed. Skirting will hide floor framing. Gaps on outside will be covered by trim pieces later. Start with front and rear skirting pieces first and attach with **4 - 1 1/2"** finishing nails per piece.

Hardware (Step 60)  
**1 1/2" - Finishing Nails**  
 x 56 total

Parts (Step 60)  
**Bottom Skirting-Bevel**  
 (7/8" x 4 1/2" x 45 1/4") x 14



**61.** Position **Narrow Door Trim** on left side of door opening and one **Door Trim** on right side of door. Right side will sit flush with **Door Jamb**. Left side will sit flush on edge of **Narrow Wall**. Do a dry run with the **Horizontal Gable Trim** from **Step 81** to determine vertical location of right trim, left trim will sit below **Drip Edge** installed in **Step 25**. Attach with **8 - 1 1/2"** Finishing Nails per piece.

Hardware (Step 61)  
**1 1/2" - Finishing Nails**  
 x 16 total

Parts (Step 61)  
**Narrow Door Trim**  
 (1/2" x 2 1/2" x 79") x 1  
**Door Trim**  
 (1/2" x 3 1/2" x 85") x 1

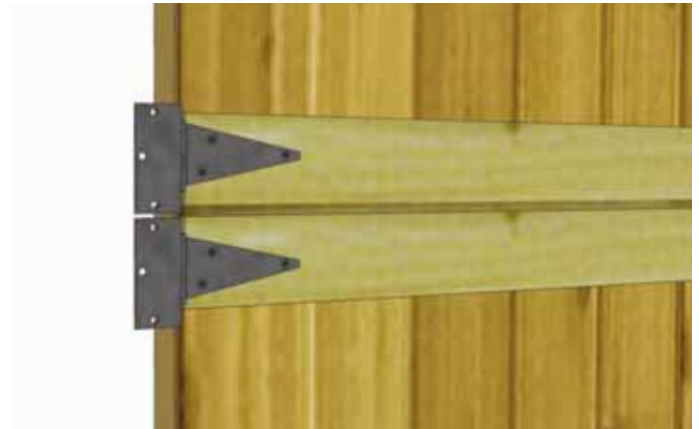
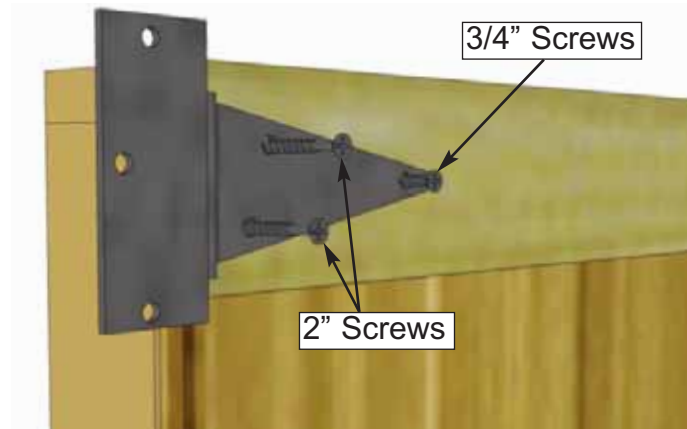
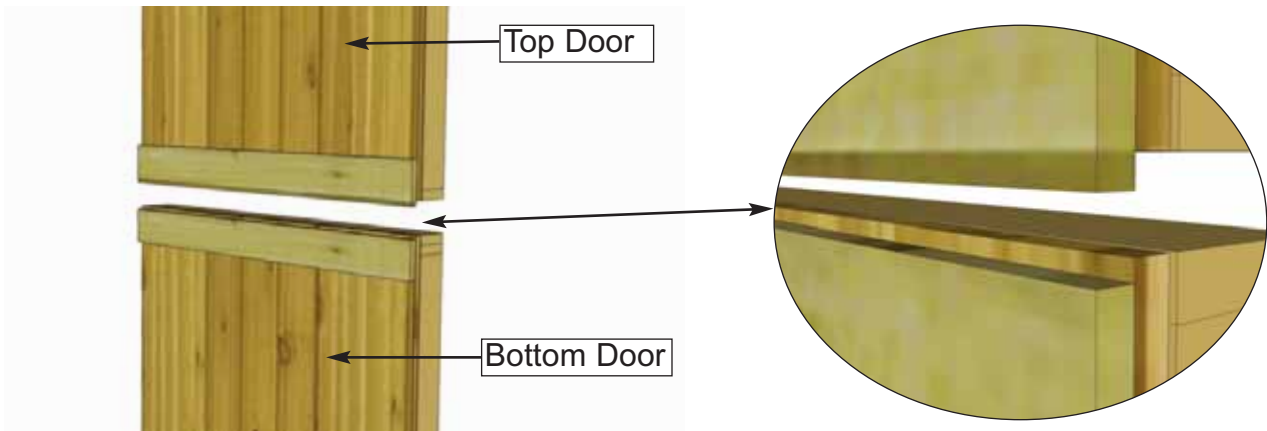

**62.** Attach Door hinges to Top and Bottom **Dutch Door** sections. Top Door has trim overhanging door at bottom while bottom door has trim recessed slightly. Hinges should be centered on door trim with barrel nudged to end of trim. Use **2" & 3/4" screws** as above.

Parts (Step 62)  
**Dutch Door**  
 (Top ) x 1  
 (Bottom) x 1

Hardware (Step 62)  
**SB2 - 2" Black Screws**  
 x 8 total  
**SB1 - 3/4" Black Screws**  
 x 4 total  
**Y1 - Black T Hinge**  
 x 4 total

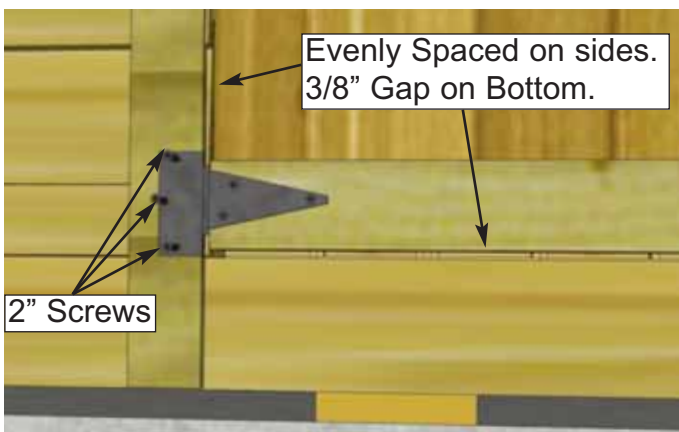

**63.** Place **Bottom Dutch Door** panel into position. Gap 3/8" on bottom, evenly space on sides, and attach hinge to doorway seam trim with **3 - 2" Black Headed Screws**. Use shim to help keep the door evenly spaced on bottom. One of the **Shim Shingles** can be used.

Parts (Step 63)  
**Dutch Door**  
 (Bottom) x 1  
**Shim Shingles**

Hardware (Step 63)  
**SB2 - 2" Black Screws**  
 x 6 total

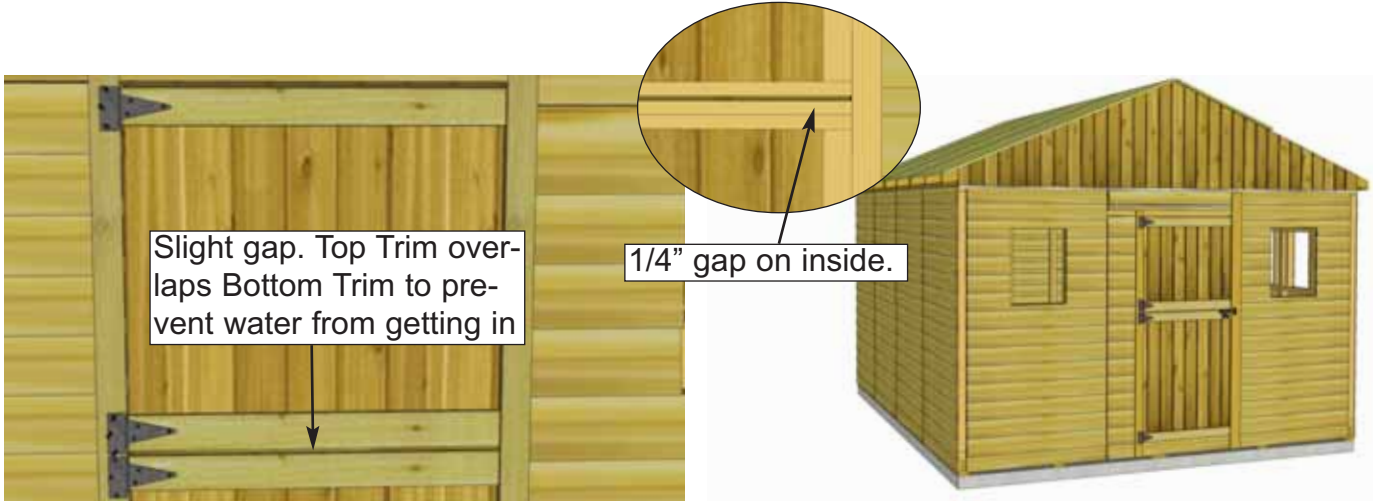

Slight gap. Top Trim overlaps Bottom Trim to prevent water from getting in

1/4" gap on inside.

**64.** Place the **Top Dutch Door** panel into place and gap top and bottom trims on the outside about 1/8" apart/ On the inside, horizontal door frames should be about 1/4" apart. Use a shim once again to help you. Attach hinges to trim with **2" Black Headed Screws** provided.

Parts (Step 64)  
**Dutch Door**  
 (Top ) x 1  
 (Bottom) x 1  
**Shim Shingles**

Hardware (Step 64)  
**SB2 - 2" Black Screws**  
 x 12 total



**65.** Attach **Door Handle, Exterior Drop Latch and Interior Barrel Bolt** to door. **Handle** is positioned on top door, **Drop Latch** on bottom door, and **Interior Barrel Bolt** (silver) on top door stud. Attach **Black Drop Latch** as illustrated above with **4 - 3/4" Black Screws**. Note how female part of Drop Latch is positioned higher than male part. Do a dry run first to position **Drop Latch** correctly. Important: Drill pilot holes with 1/8" drill bit prior to securing to prevent wood from splitting.

Hardware (Step 65)  
**SB1 - 3/4" Black Screws**  
 x 16 total  
**Y3 - Black Handle**  
 x1  
**Y4 - Black Drop Latch**  
 x1  
**Y5 - Silver Barrel Bolt**  
 x1

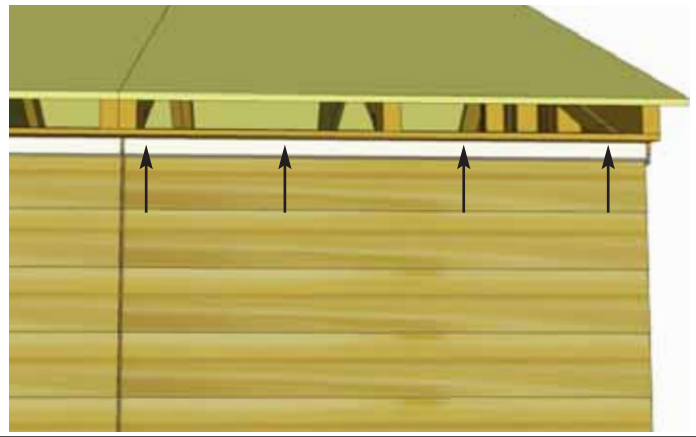
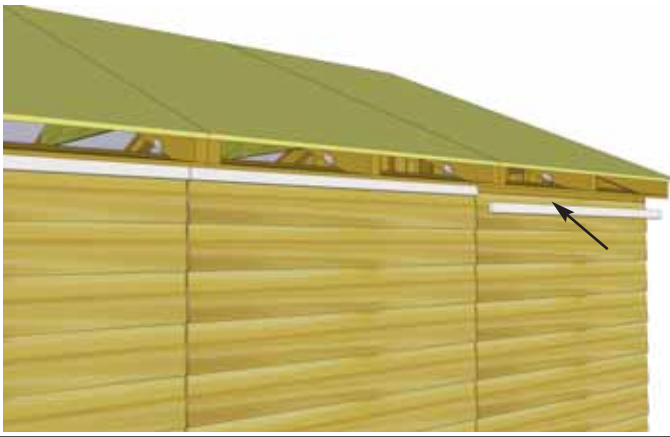

**66.** Trim out side walls by attaching **Top Wall Trim**. Position with thick end of Bevel downwards at top of wall, tight against Soffits. Attach with **4 - 1 1/2" Finishing Nails** per piece. Complete both sides.

Parts (Step 66)

**Top Wall Trim**

(3/4" x 1 1/2" x 45 1/4") x 8

Hardware (Step 66)

**N1 - 1 1/2" Finishing Nails**

x 32 total



**67.** Attach **Filler Trim** to front and rear walls in each corner. Attach with **8 - 1 1/2" Finishing Nails** per piece. Strips are positioned flush with bottom skirting.

Parts (Step 67)

**Filler Trims**

(3/4" x 2 1/2" x 81 3/4") x 4

Hardware (Step 67)

**N1 - 1 1/2" Finishing Nails**

**Nails**

x 32 total

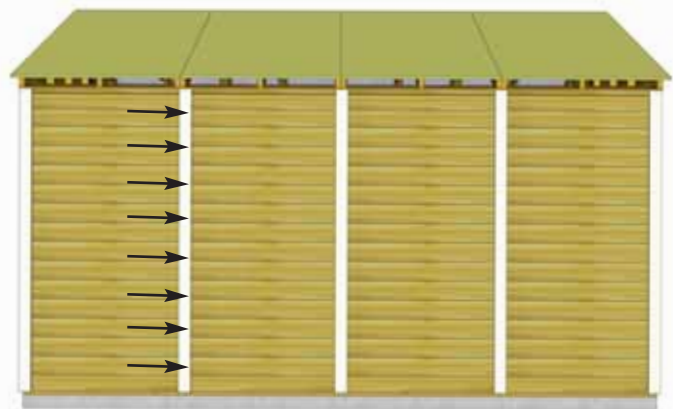

**68.** Attach **Side Trims** to cover side wall seams and in the corners. align tight underneath **Soffit** and even with **Filler Trims**. Attach each with piece with **8 - 1 1/2" Finishing Nails**. Note: Trim may sit slightly below **Bottom Skirting**.

Parts (Step 68)

**Side Trims**

(1/2" x 2 1/2" x 87") x 10

Hardware (Step 68)

**N1 - 1 1/2" Finishing Nails**

**Nails**

x 80 total

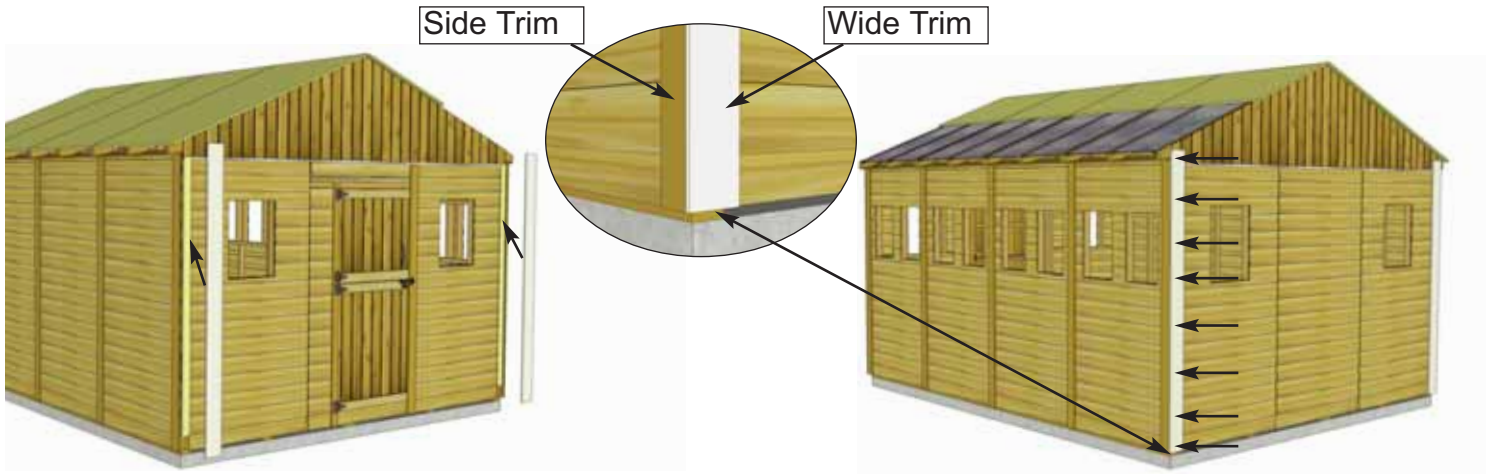

**69.** Attach **Wide Corner Trims** over **Filler Trims**. Wide Trim will cap Side Trims. Attach with **8 - 1 1/2" Finishing Nails** per piece.

Parts (Step 69)  
**Wide Corner Trims**  
 (1/2" x 5 1/2" x 90") x 4

Hardware (Step 69)  
**N1 - 1 1/2" Finishing Nails**  
 x 32 total

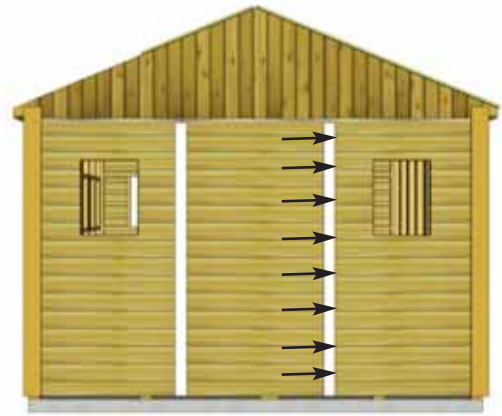

**70.** Attach **Rear Wall Trims**. to rear of shed. Use **8 - 1 1/2" Finishing Nails** per piece.

Parts (Step 70)  
**Rear Wall Trims**  
 (1/2" x 2 1/2" x 85") x 2

Hardware (Step 70)  
**N1 - 1 1/2" Finishing Nails**  
 x 16 total

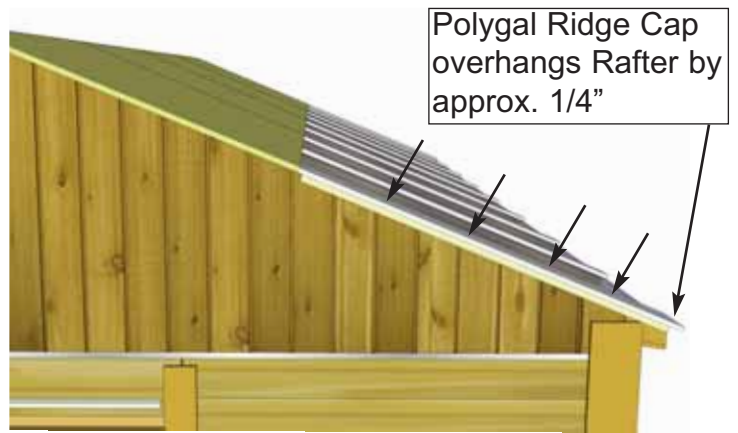
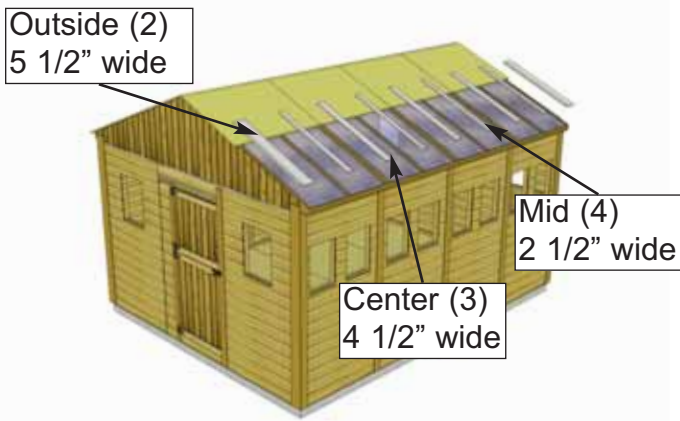

**71.** Locate all **Polygal Ridge Caps** (4 Mid, 2 Outside, and 3 Center). Starting from the outsides, position both 5 1/2" wide caps so the long edge with pre-attached fascia nailing strip is below Plywood roof panel. When correctly aligned, attach Caps to center of outside Rafter with **4 - 1 1/2" Finishing Nails**. Use a straight edge to align Cap with Plywood Roof Panels. See above.

Parts (Step 71 - 73)  
**Outside Polygal Ridge Caps**  
 (1/2" x 5 1/2" x 44") x 2  
**Center Polygal Ridge Caps**  
 (1/2" x 4 1/2" x 44") x 3  
**Mid Polygal Ridge Caps**  
 (1/2" x 2 1/2" x 44") x 4

Hardware (Step 71 - 73)  
**N1 - 1 1/2" Finishing Nails**  
 x 36 total

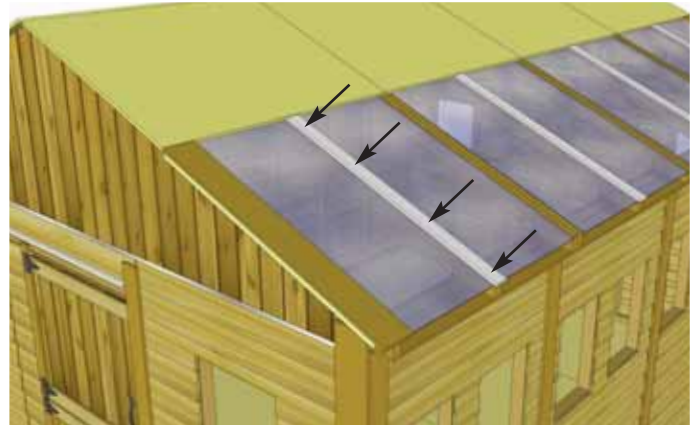

**72.** Position and attach **Mid Ridge Caps** evenly spaced on single **Rafters**. Align top to bottom as per **Step 71**. Secure each piece with **4 1 1/2" Finishing Nails**.

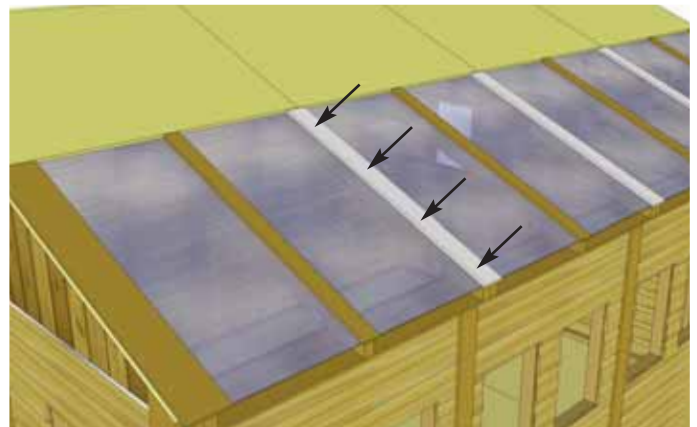
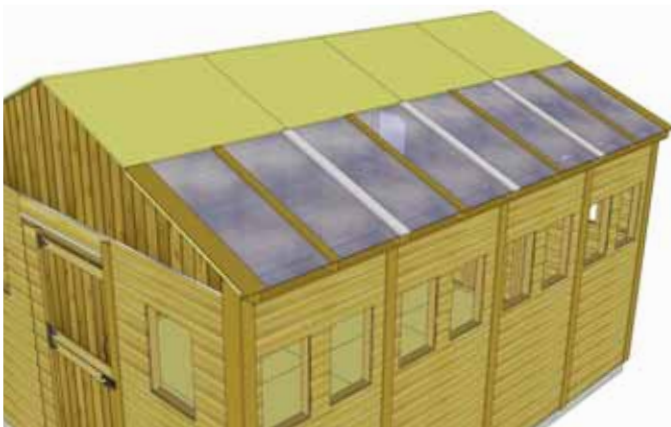

**73.** Position and attach **Center Ridge Caps** evenly spaced on double **Rafters**. Align top to bottom as per **Step 72**. Secure each piece with **4 1 1/2" Finishing Nails**.





**74.** Attach **Facia Cleat Short** centered on underside of Polygal Side of roof plywood, flush to edge. Attach **Facia Cleat Long** to underside of roof on Non-Polygal side, flush edge to edge. Repeat this step on rear of shed. Fasten each cleat with **3 - 1 1/4" screws** per piece..

Parts (Step 74)  
**Facia Cleat Short**  
 (3/4" x 1 1/2" x 36 1/2") x 2  
**Facia Cleat Long**  
 (3/4" x 1 1/2" x 40") x 4

Hardware (Step 74)  
**S2 - 1 1/4" Screws**  
 x 18 total

**Expert Advice:** Do a dry run by lining up Front, Rear and Side Facia to confirm positioning prior to attaching

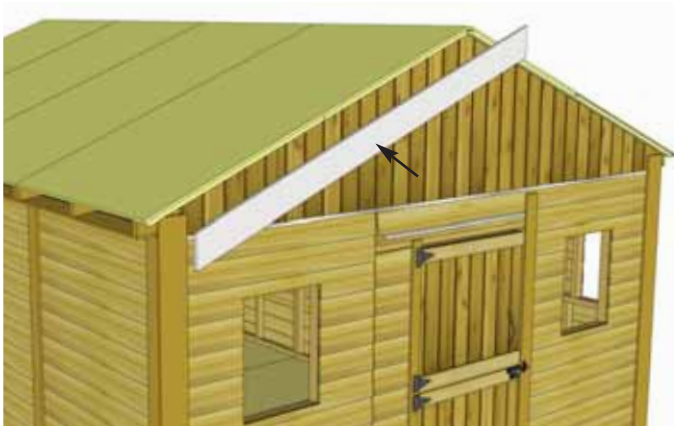

**75.** Attach **Front and Rear Facia (angle cut on ends)**, to **Facia Cleats** on Non-Polygal Roof side, with **10 - 1 1/2" Finishing Nails** per piece. Line up Facia so Facia ends line up with **Rafter** ends.

Hardware (Step 75, 77)  
**N1 - 1 1/2" Finishing Nails**  
 x 40 total

Parts (Step 75, 77)  
**F&R Facia (angled ends)**  
 (3/4" x 5 1/2" x 81 1/4") x 4

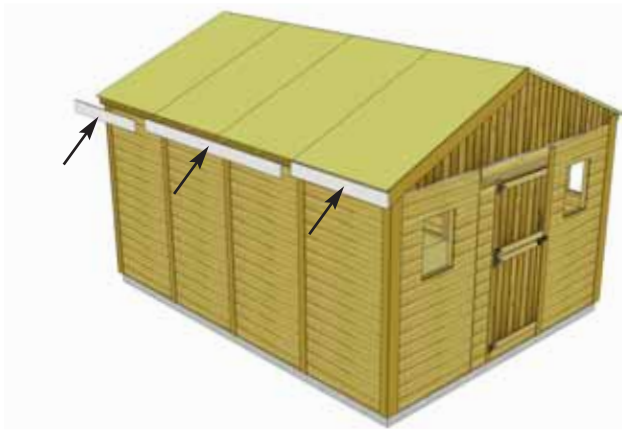

**76.** Attach **Side Fascia** to roof **Rafter** ends. There are 3 **Side Fascia** pieces per side. Secure with **8 - 1 1/2" Finishing Nails** per piece. **Side Fascia** will cap **Front and Rear Fascia**.

Parts (Step 76, 78)

**Side Fascia**

(3/4" x 5 1/2" x 49 1/2") x 4  
(3/4" x 5 1/2" x 89 1/4") x 2

Hardware (Step 76, 78)

**N1 - 1 1/2" Finishing Nails**  
x 48 total

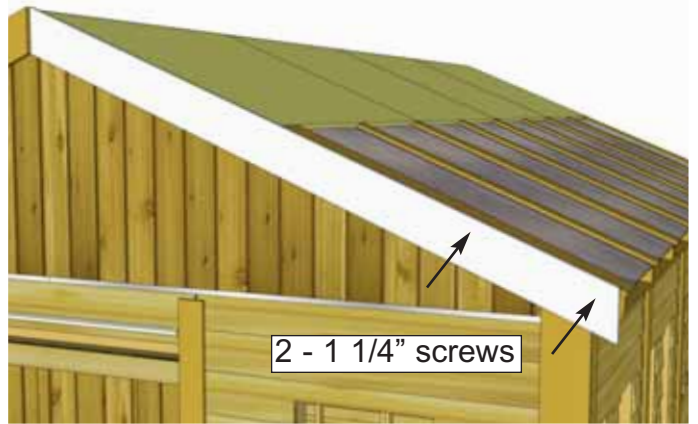
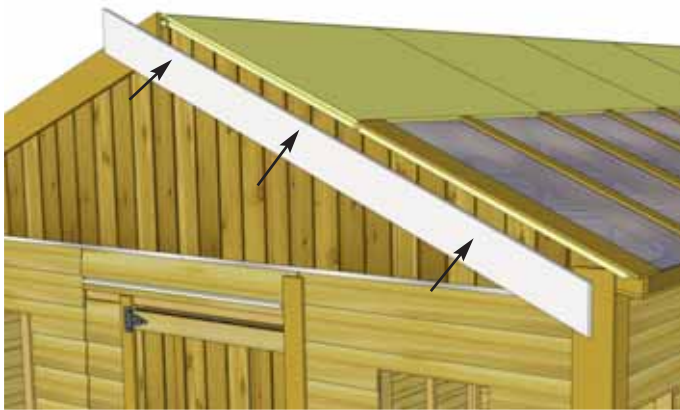

**77.** Attach remaining **Front & Rear Fascia** pieces to **Fascia Cleats** and Outside **Ridge Cap** edge with **10 - 1 1/2" Finishing Nails** and **2 - 1 1/4" screws**. Use screws where **Outside Ridge Cap** and **Fascia** meet. Once again, line up **Fascia** so it is aligned with **Rafter** ends. Do a dry run with **Front, Rear and Side Fascia** to confirm positioning prior to attaching.

Hardware (Step 77)

**S2 - 1 1/4" Screws**  
x 4 total



**78.** Attach remaining **Side Facia** to roof **Rafter** ends as per **Step 76**. **Side Facia** fits underneath **Polygal Panels** and **Polygal Ridge Caps**.



**79.** Attach **Door Trim** to cover seam between **Window Wall Panel** and **Narrow Wall Panel**. Use **8 - 1 1/2" Finishing Nails**.

Parts (Step 79)  
**Left Door Trim**  
 (1/2" x 3 1/2" x 85") x 1

Hardware (Step 79)  
**N1 - 1 1/2" Finishing Nails**  
 x 8 total



**80.** Attach **Horizontal Door Trims** above door and below **Drip Edge**. Attach with **2 - 1 1/2" Finishing Nails** for short piece and **4 - 1 1/2" Finishing Nails** for longer piece.

Parts (Step 80)  
**Horizontal Door Trim**  
 (1/2" x 2 1/2" x 8") x 1  
 (1/2" x 2 1/2" x 32") x 1

Hardware (Step 80)  
**N1 - 1 1/2" Finishing Nails**  
 x 6 total



**81.** Locate **Horizontal Gable Trims** for both front and rear of shed. Position equally over Gable and Wall seam. Attach each piece with **6 - 1 1/2" Finishing Nails**.

Parts (Step 81)  
**Horizontal Gable Trims**  
 (3/4" x 4 1/2" x 42") x 2  
 (3/4" x 4 1/2" x 45 1/4") x 4

Hardware (Step 81)  
**N1 - 1 1/2" Finishing Nails**  
 x 36 total



**82.** Attach **Facia Detail Plates** and **Pentagon Detail Plates** to cover seams where **Facia** and **Trim** pieces come together. Secure each with **4 - 1 1/2" Finishing Nails**.

Parts (Step 82)  
**Pentagon Detail Plates**  
 (9 1/2" x 7 1/2") x 2  
**Facia Detail Plates**  
 (8" x 5 1/2") x 4

Parts (Step 82)  
**Gable Detail Plates**  
 (8" x 4 1/2") x 4  
Hardware (Step 82)  
**N1 - 1 1/2" Finishing Nails**  
 x 36 total

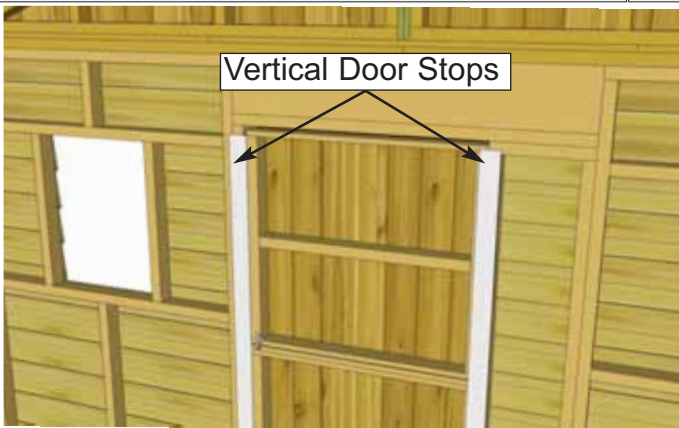

**83.** Attach **Interior Vertical** and **Horizontal Door Stops** to door framing from inside of shed. Use **4 - 2" screws** to secure each stop. Stops should overlap door by approx. 1/2".

Parts (Step 83)  
**Door Stops**  
 (1/2" x 2 1/2" x 72") x 2  
 (1/2" x 2 1/2" x 36") x 1

Hardware (Step 83)  
**S3 - 2" Screws**  
 x 12 total

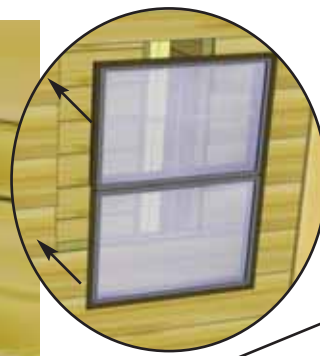
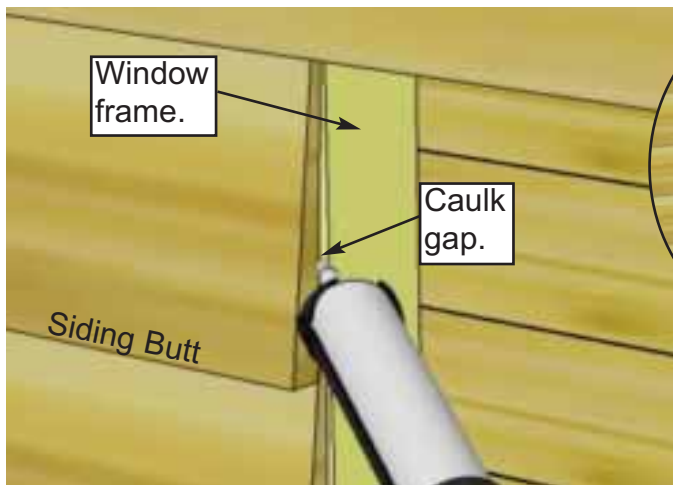

Screw insert into bottom (thick) part of siding.



**84.** To reduce possible water from penetrating into the window cavity, caulk gap on both sides of window opening prior to installing **Window Insert**. Position insert in cavity and screw with **6 - 1 1/4" Screws**. On sides, make sure to screw insert into the thick butt of the siding only.

Parts  
**Reg Window x 4**  
**Narrow Window x 8**

Hardware  
**S2 - 1 1/4" Screws**  
 x 72 total

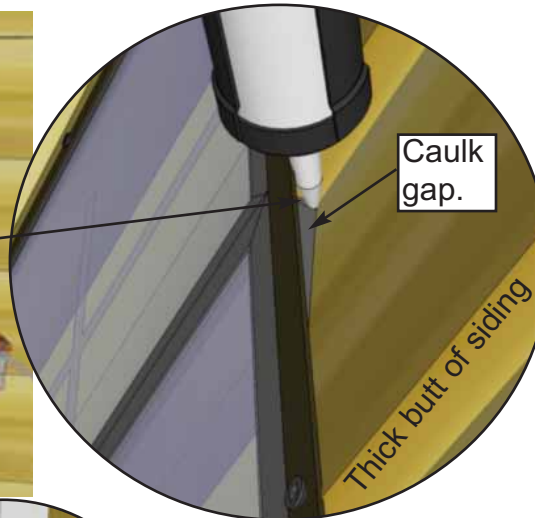

**84b.** Once Insert is attached, caulk the "triangular gap" between the Insert's outside flange and the siding. Also put a bead of caulking horizontally at top of window where the flange and siding meet. This additional caulking will also will reduce the chances of moisture entering into your shed.

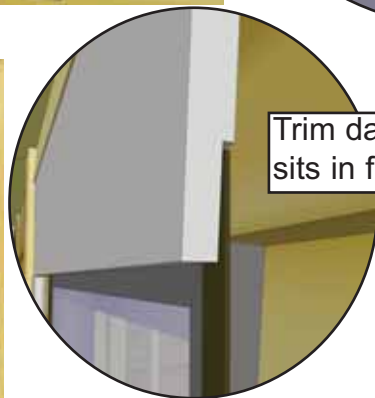

Trim dado sits in flange.



**85.** Position **Window Trim** around window doing a dry run first and attach with **4 - 1 1/2" Finishing Nails** per piece. There are two Trim Kits (Regular/Narrow). The regular window kit = 1" x 24 1/16" = top (angle cut on ends), 3" x 23" = Sides and Bottom. Narrow window kit = 1" x 19 7/8" Top, 2" x 21 7/16" Sides, 1" x 18 3/4" Bottom. Window trim has a small dado on reverse face. Outside flange of window will roughly sit in the dado to give a better fit.

Hardware (Step 85)  
**N1 -1 1/2" Finishing Nails**  
 x 192 total

Parts (Step 85)  
**Regular Window Trim x 4**  
**Narrow Window Trim x 8**



**86.** Assemble **Flower Box Kits** with Assembly Instructions included. Position completed Flower Box below bottom of window trim and secure with **2 - 2 1/2" screws**. Screw from inside of box into the center wall stud. Attach second screw 2" underneath first screw and once again into the wall stud. Install Flower Box Kits underneath each window/double-window..

<p><u>Hardware (Step 86)</u>  <b>S1 - 2 1/2" Screws</b>          x 16 total</p>
<p><u>Parts (Step 86)</u>  <b>Flower Box Kits</b>          x 8</p>

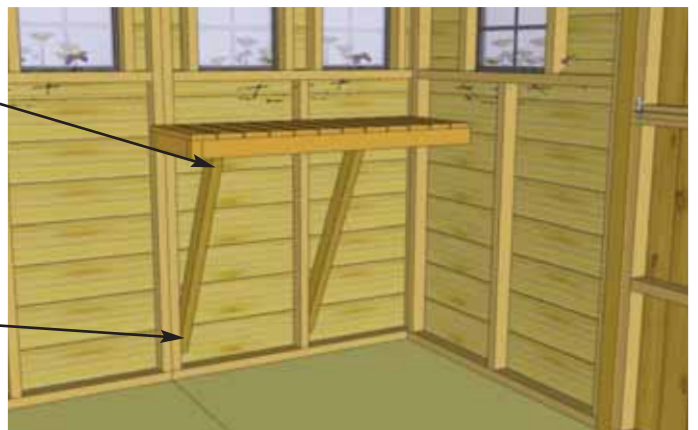
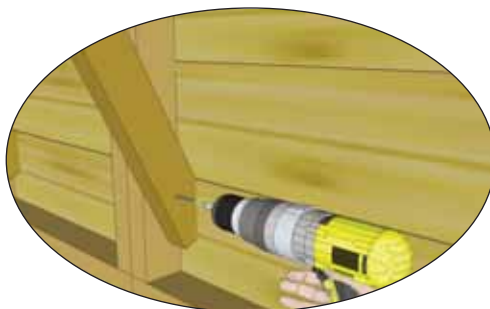

**87.** Locate **Long Potting Shelf** and 2 **Potting Shelf Legs**. Position shelf in corner tight against wall framing. While supporting the shelf, attach shelf with **2 - 2 1/2" screws** to wall frame. Place leg underneath shelf and attach to inside shelf framing and wall framing as illustrated above with **2 - 2 1/2" screws**.

<p><u>Parts (Step 87)</u>  <b>Long Potting Shelves</b>          (16" x 45") x 4  <b>Short Potting Shelf</b>          (16" x 41") x 1  <b>Potting Shelf Legs</b>          (1 1/2" x 2 1/2" x 38") x 9</p>
----------------------------------------------------------------------------------------------------------------------------------------------------------------------------------------------------------------------------------

<p><u>Hardware (Step 87)</u>  <b>S1 - 2 1/2" Screws</b>          x 38 total</p>
-----------------------------------------------------------------------------------------



**88.** Place next **Potting Shelf** against wall framing and end of Long Shelf framing. Attach with **2 - 2 1/2" screws** as per **Step 87** to first shelf and wall framing. Use a level to confirm shelving is square and level. Attach legs as previously illustrated. Screw to wall stud and up into the underside of shelf framing. Continue attaching shelves along wall as per **Steps 87-88**. Short Potting Shelf goes in the corner and only receives one leg.

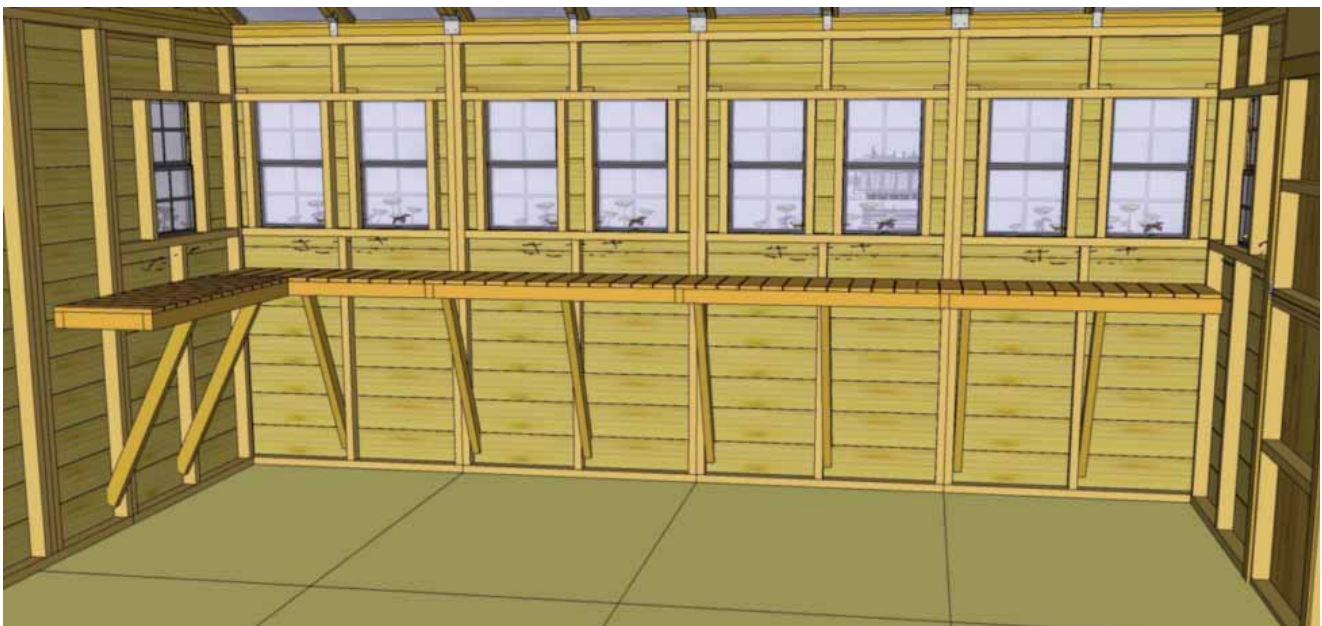

**Congratulations on completing  
your new 12 x 16 Sunshed  
Garden Shed!**

# Outdoor Living Today Flower Box Assembly Instructions

## Parts Lists:

A - Base, Rear & Front Box Frames	(3pcs)	3/4" x 5 1/2" x 23"
B - End Cap Frames	(2pcs)	3/4" x 5 1/2" x 7" / 8"
C - Front Trim	(1 pc)	3/4" x 1 1/2" x 26"
D - Side Trims	(2 pc)	3/4" x 1 1/2" x 8 3/4"
E - Brackets	(2 pc)	1 1/2" x 5 1/2" x 5 1/2"
F - 1 1/4" Screws		
G - 1 1/4" Nails		

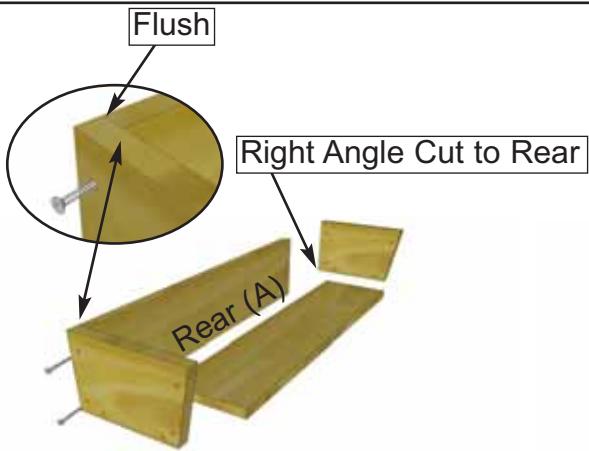
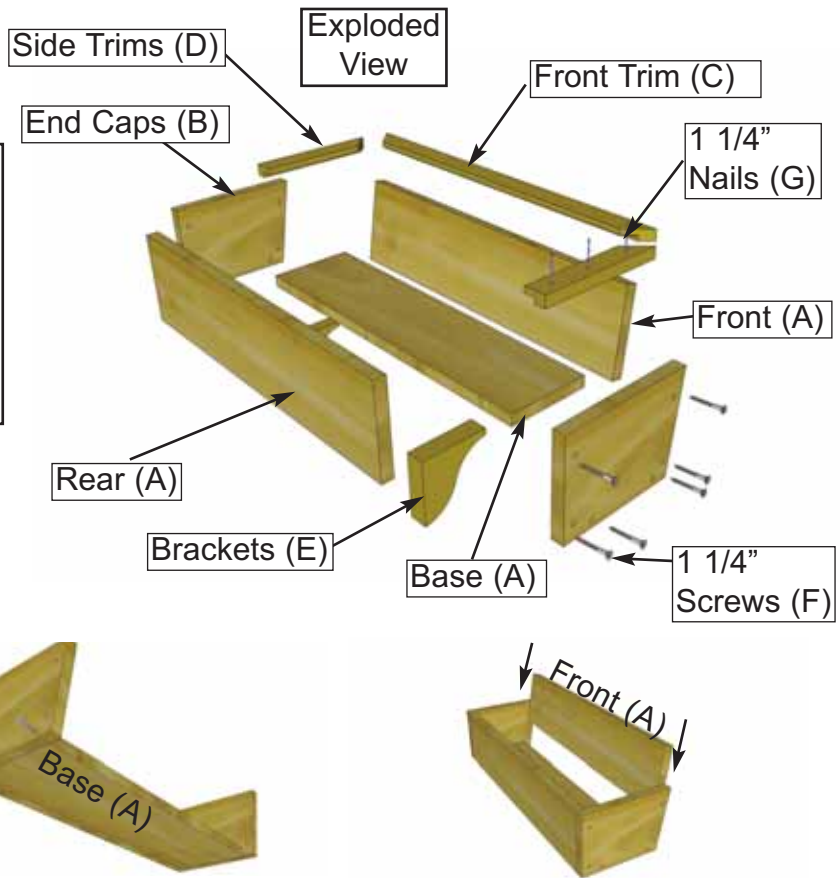

**1.** On a table position Rear Box and End Cap Frames together so flush at top. Fasten together with 2 - 1 1/4" screws. Place Base Frame tight against Rear and End Cap and flush at bottom. Secure with 2 - 1 1/4" screws. Complete attachment of remaining End Cap Frame. Slide Front Frame between End Caps.

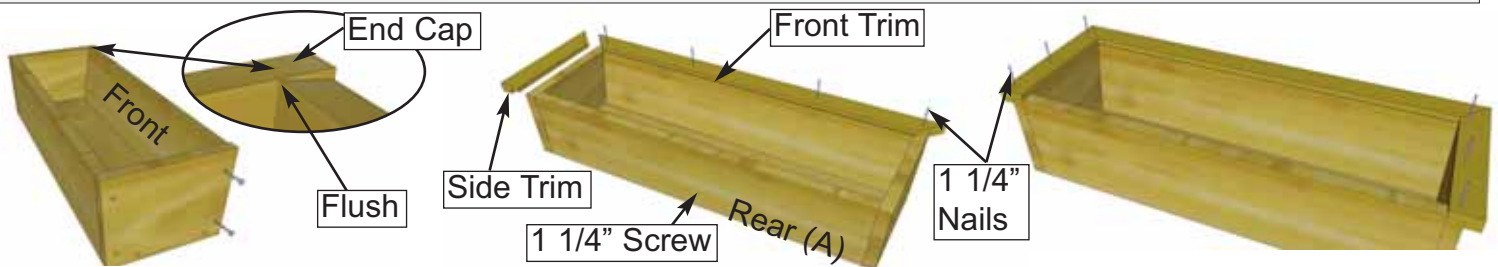

**2.** Position Front Frame Piece flush with End Cap. Attach both ends with 2 - 1 1/4" screws. Pilot hole Rear Box Frame near bottom center and secure to Base edge with 1 - 1 1/4" screw. Evenly position Front Trim (mitre cut on end and dado cut on inside bottom) tight against front frame and nail down with 4 - 1 1/4" nails. Position Side Trims as per Front and secure with 3 - 1 1/4" nails per side.

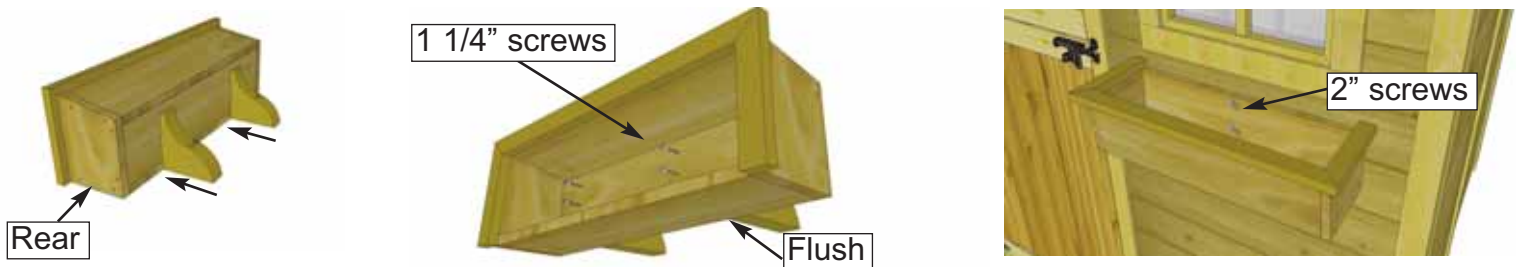

**3.** On a flat surface, flip Flower Box on it's rear face. Evenly space Brackets and secure through Base Frame and into the Brackets with 2 - 1 1/4" screws per Bracket. Position completed Flower Box beneath window trim and screw from inside of box into the center wall stud with 2 - 2" screws. (2" screws supplied with Base Kit.)



**Note;** Our Sheds are shipped as an unfinished product. If exposed to the elements, the western red cedar lumber will weather to a silvery-gray color. If you prefer to keep the cedar lumber looking closer to the original color, we suggest that you treat the wood with a good oil base wood stain. You may also wish to paint your new shed rather than stain it. In both cases we recommend that you consult with a paint and stain dealer in your area for their recommendations.



We hope your experience constructing our building has been both positive and rewarding.

We value your feedback and would like to hear back from you on how well we are doing in the following areas:

1. **Customer Service**
2. **On Time Shipping**
3. **Motor Freight Delivery**
4. **Quality of Materials**
5. **Assembly Manual**
6. **Overall Satisfaction.**



The materials contained in this Assembly Manual may be downloaded or copied provided that ALL copies retain the copyright and any other proprietary notices contained on the materials. No material may be modified, edited or taken out of context such that its use creates a false or misleading statement or impression as to the positions, statements or actions.

Please call, write or email us at:

**Outdoor Living Today**

Canadian Address  
9393 287th Street  
Maple Ridge, British Columbia  
Canada V2W 1L1

United States Address  
P.O. Box 96  
Sumas, Washington  
USA 98295