



# 8x4 SpaceSaver Sliding Door - Metal Roof - AK Assembly Manual

Stock Code:  
SS84-SLIDER-METAL-AK

Revision #1.5  
September 20, 2022

Thank you for purchasing a 8x4 SpaceSaver Shed with Sliding Door. Please take the time to identify all the parts prior to assembly.

Please be aware that it is the customers' sole responsibility to acquire the necessary building permits and or obtain approval from their local county, municipality or HOA prior to purchasing. Generally, shed structures under 100 square feet do not require permits in most jurisdictions in the United States and Canada.



- Snow load ratings vary by geographical location. If heavy or wet snowfall occurs, it is advisable to sweep snow off roof frequently.
- If the product is elevated, any structural and building code requirements are solely the customer's responsibility, and should be abided by.
- In areas with high or gusty wind conditions, it is advisable to install the structure securely to the ground.
- Have a regular maintenance plan to ensure screws, doors, windows and parts are tightly affixed.



Customer agrees to hold Outdoor Living Today and any Authorized Dealers free of any liability for improper installation, maintenance and repair.

In the event of a missing or broken piece, call the Outdoor Living Today Customer Support Line @ 1-888-658-1658 within 30 days of the delivery of your purchase. It is our commitment to you to courier replacement parts, free of charge, within 10 business days of this notification. Replacement parts will not be provided free of charge after the 30 day grace period.

All structures purchased from Outdoor Living Today are covered for a period of one year for defects in manufacturing and workmanship. Costs incurred for customer installations are not included.

Failure to use supplied parts included in this kit could result in poor product performance and may void your warranty. Please contact Outdoor Living Today's Customer Toll Free Line if you plan to deviate from our written instructions.

# What to do before my Shed arrives?



- Become familiar with this assembly manual and determine if you can complete the project yourself or will require a professional contractor.



- One helper is recommended to assist in constructing your shed. It generally takes two people two days to assemble a shed. If you're hiring a contractor, their rate should be in line with that duration of work.



- Clear the construction area and ensure a clear pathway for delivery when the freight company arrives. Remove all debris: roots, grass, rocks, etc.



- Excavate the site. Contact your local utilities company to ensure there are no gas or electric lines buried in the area before digging.

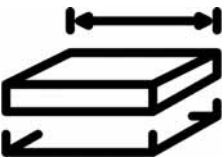

- Decide on the type of foundation you will be using:
  - Concrete slab, or
  - 4-6 inches of crushed gravel with paver stones or 4x4 stringers.

You can find the footprint for your shed on Page 3 of your Assembly Manual.

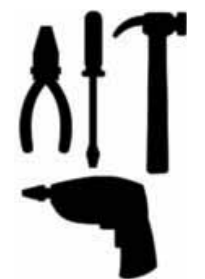

- If doing the assembly yourself, have all the necessary tools ready to go and in working condition. A list of required tools can be found after the parts list.

# Foundation Types for 8x4 Garden Shed

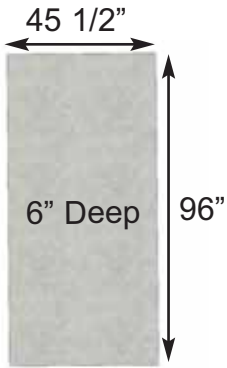

**Concrete Foundation**

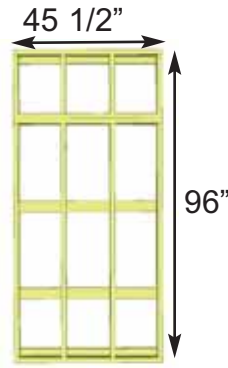

**Floor Frame**



**Completed Foundation**

**Concrete Slab Foundation:**

- Slab must be at least the same size as assembled floor frame (45 1/2" x 96") or larger.
- 6" Deep foundation.
- 0.6 Cubic Yards of concrete required.
- A concrete slab will have the longest durability out of your foundation options.

**Once level, a concrete slab is the easiest surface to build on.**

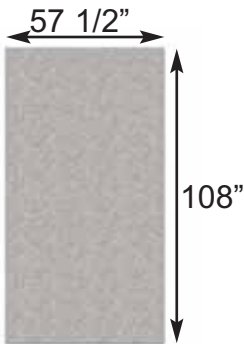

**Gravel Foundation**

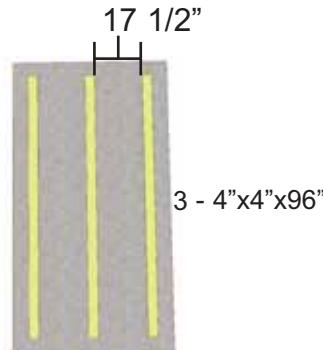

**Gravel Foundation with treated stringers**



**Completed Foundation**

**Gravel with 4x4 Pressure Treated Stringers:**

- Excavate at least 6" deep, and 6" wider than floor frame on each side.
- 1.0 Cubic Yards of gravel required, approximately 9 wheelbarrows.
- 3 - 4x4 Pressure Treated Stringers 8' long required.
- Evenly spaced, with one at each end of floor frame.

**Saves money on materials, easy to level and work with.**

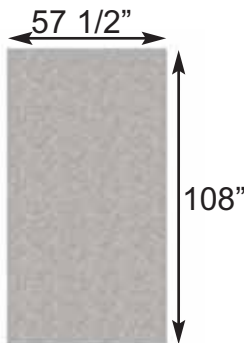

**Gravel Foundation**

15 Patio Stones



**Gravel Foundation with Patio Pavers**



**Completed Foundation**

**Gravel with Patio Paver Stones:**

- Excavate at least 6" deep, and 6" wider than floor frame on each side.
- 1.0 Cubic Yards of gravel required, approximately 9 wheelbarrows.
- 15 patio pavers (8" x 8" or larger).
- Center patio paver stones underneath floor runners and underneath seams in floor joists.

**Patio paver stones are widely available from most landscape stores.**

**Thank you for purchasing our 8x4 SpaceSaver Shed with Sliding Door.  
Please take the time to identify all the parts prior to assembly.**

## **Parts List:**

### **A. Floor Section**

- 1 - 45 1/2" x 75" - **Large Floor Frame** (2 Joists unattached)
- 1 - 45 1/2" x 21" - **Small Floor Frame** (2 Joists ATTACHED)
- 2 - 1 1/2" x 3 1/2" x 71 7/8" - **Floor Joists**  
(Steps 1 - 3)

- 2 - 1 1/2" x 3 1/2" x 45 1/2" - **Floor Runners Short**
- 3 - 1 1/2" x 3 1/2" x 47 3/4" - **Floor Runners Long**  
(Steps 4 - 5)

- 1 - 5/8" x 45 1/2" x 75" - **Plywood Flooring**
- 1 - 5/8" x 45 1/2" x 21" - **Plywood Flooring**  
(Steps 6 - 8)

### **B. Wall Section**

- 5 - 1 1/2" x 2 1/2" x 45 1/2" - **Bottom Wall Plates**
- 4 - 45 1/2" x 75" - **Wall Panels**
- 1 - 45 1/2" x 73" - **Front Wall Panel**  
(Steps 9 - 17)

- 1 - 2" x 3 1/2" x 68 1/4" - **Door Header - Long (Dado on edge)**
- 1 - 2" x 3 1/2" x 22 3/4" - **Door Header - Short (Dado on edge)**
- 1 - 1 1/2" x 3 1/2" x 73" - **Door Jamb - Vertical**
- 1 - 1 1/2" x 2 1/2" x 44" - **Interior Door Header**  
(Steps 18 - 19)

- 2 - **Top Triangular Siding Pc for Angle Wall Extenders (L/R)**
- 2 - 45 1/4" - **Angle Wall Extenders (L/R)**
- 2 - 9" x 45 1/2" - **Wall Extenders**  
(Steps 20 - 27)

- 1 - 3/4" x 3 1/2" x 70" - **Horizontal Wall Cleat**
- 1 - 3/4" x 3 1/2" x 21" - **Horizontal Wall Cleat**  
(Step 27)

### **C. Rafter & Roof Section**

- 6 - 1 1/2" x 2 1/2" x 54" - **Rafters**
- 2 - 1" x 3 1/2" x 48" - **Front Soffits**
- 2 - 1/2" x 3 1/2" x 48" - **Rear Soffits**  
(Steps 31 - 36)

- 6 - 3/4" x 3 1/2" x 50" - **Roof Battens**
- 4 - 3/4" x 1 1/2" x 21 1/2" - **Batten Spacers**  
(Step 37 - 40)

- 2 - **Rafter/Facia Nailing Strips** - 3/4" x 3/4" x 51"  
(Step 41)

- 3 - **Metal Roof Panels** - 39"w x 58 1/2"d  
(Step 42 - 48)

- Foam Enclosures for Metal Roof** - Several Strips  
(Step 47, 66)

### **D. Miscellaneous Section**

#### **(Skirting, Trim, Door, Facia & Misc. Parts)**

- 4 - 3/4" x 4 1/2" x 45 1/4" - **Bottom Skirting** (Bevel Siding)
- 2 - 1/2" x 4" x 45 1/4" - **Front Bottom Skirting** (non Bevel)  
(Steps 49 - 51)

- 6 - 7/8" x 2 1/2" x 36" - **Corner Filler Trims**
- 2 - 7/8" x 2 1/2" x 10" - **Rear Top Corner Filler Trims**
- 2 - 3/4" x 2 1/2" x 36" - **Corner Filler Trims - Front Left** (Step 18)  
(Steps 18 & 29 & 52)

- 2 - 1/2" x 5 1/2" x 78 1/2" - **Front Corner Trims**
- 2 - 1/2" x 5 1/2" x 88 3/4" - **Rear Corner Trims**
- 2 - 1/2" x 2 1/2" x 80" - **Side Front Corner Trims**
- 1 - 1/2" x 2 1/2" x 88 3/4" - **Rear Middle Trim**
- 2 - 1/2" x 2 1/2" x 88 3/4" - **Side Rear Corner Trims**  
(Steps 53 - 56)

#### **Sliding Door Parts**

- 1 - 49" x 73" - **Sliding Door**
- 1 - 71" long - **Aluminum Door Track with Hanging Brackets**
- 1 - 1 1/2" x 1 5/8" x 80 3/4" - **Lower Door Track**
- 1 - 3/4" x 3" x 87 3/4" - **Lower Door Track Cover**
- 2 - 1 1/2" x 2 1/4" x 3 1/2" - **Lower Door Track Stops**
- 1 - 1 1/2" x 2 1/2" x 66 1/4" - **Door Stop**  
(Steps 57 - 62)

- 2 - 1/2" x 4" x 54 1/8" - **Side Facia** (Angle Cut Ends) - reverse
- 4 - 1/2" x 4" x 50 1/2" - **Front and Rear Facia**  
(Steps 63 - 65)

- 2 - 60" long - **Metal Ridge Caps**  
(Step 67)

- 1 - **Detail Facia Plates** (4" high)  
(Step 68)

- 1 - 18" x 22 1/2" - **Window Insert**
- 1 - 24 1/16" angle cut / 3 -23" straight cut - **Window Trim Pkg**  
(Step 69 - 70)

- 1 - 45 1/4" - **Extra Piece of Bevel Wall Siding** - Use if wall panel siding is damaged or to shim floor or door.

**Note: All Trim, Facia and Bottom Skirting pieces will be positioned rough face out when installed.**

# 8x4 SPACESAVER WITH SLIDING DOOR HARDWARE PACKAGE

## Hardware Kit (Provided)

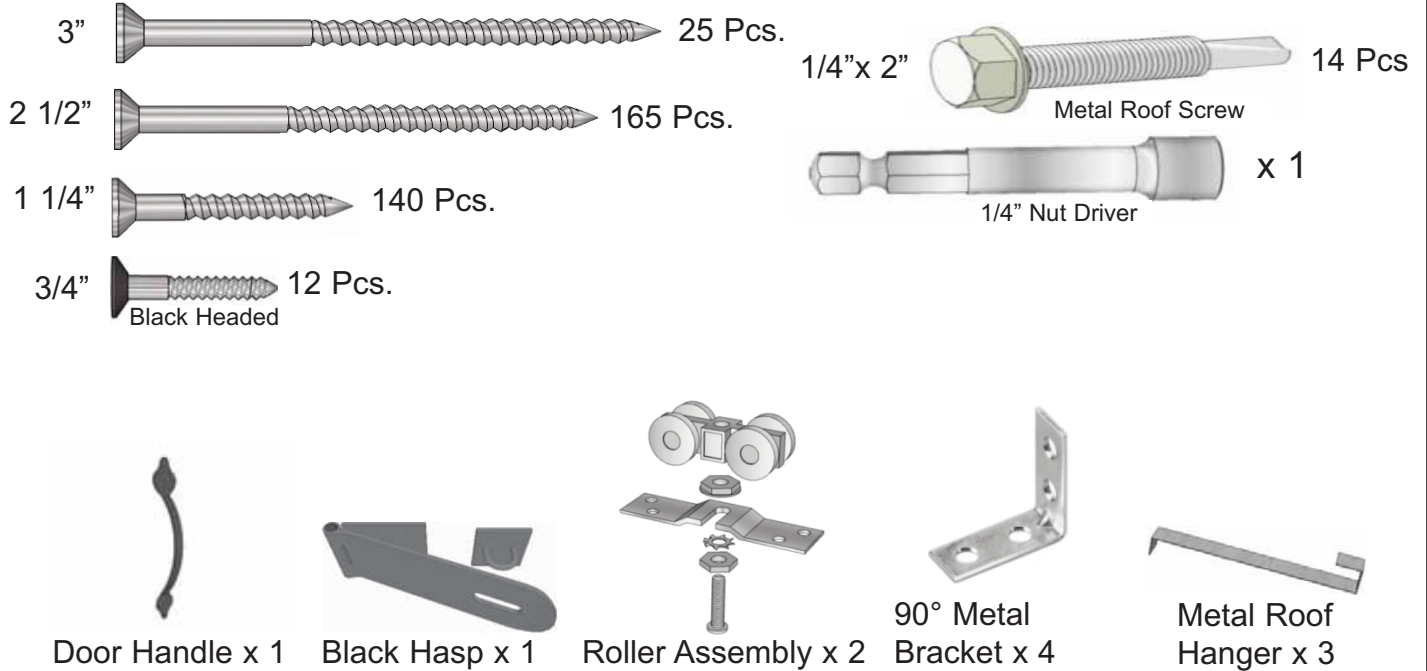

## Tools Required (Not Provided)

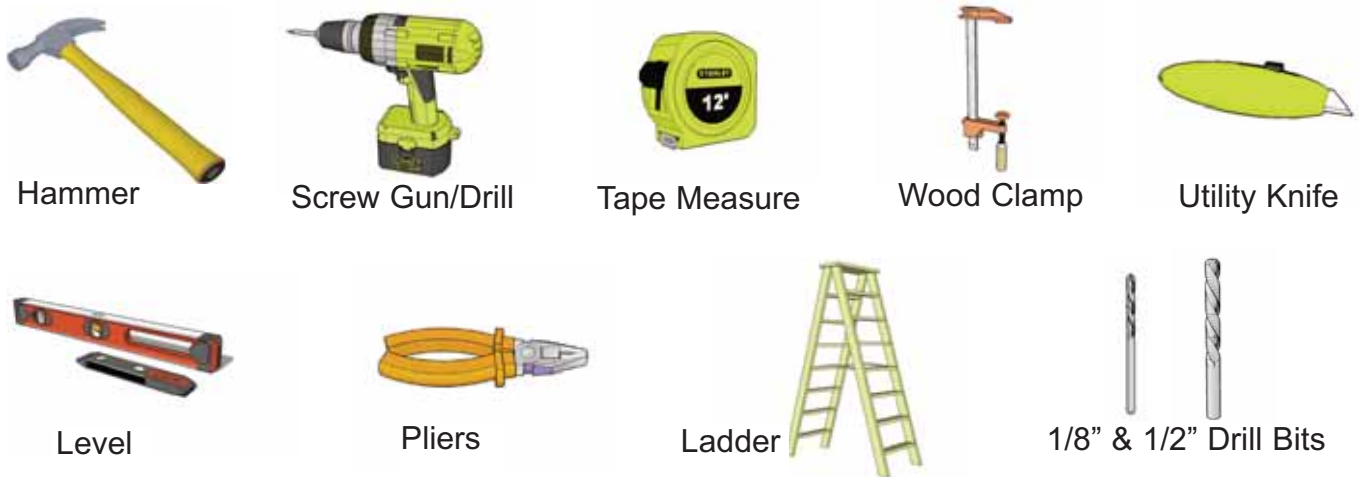

## Safety Equipment Required (Not Provided)



## Before/During Assembly:

- 1.) Paint each face and edge of your plywood floor with a latex exterior paint.
- 2.) Caulk wall seams if gaps appear.
- 3.) Caulk around window framing.
- 4.) Caulk perimeter between floor plywood and bottom wall plate.
- 5.) Caulk channels in lap siding at the top of your door above the trim, just a drop in each channel.
- 6.) Caulk edge of door threshold if applicable.
- 7.) Optional: Install a Sill Gasket between floor runners and foundation.
- 8.) Optional: Install an 8" strip of roofing paper below Cedar Ridge Caps for Cedar Roof Sheds.

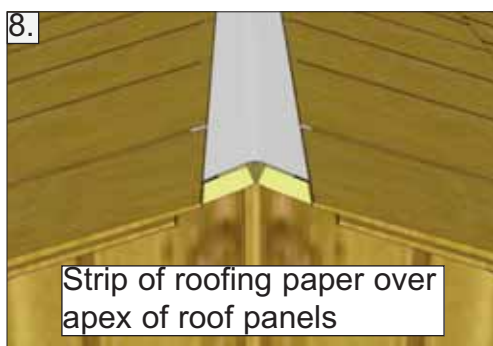
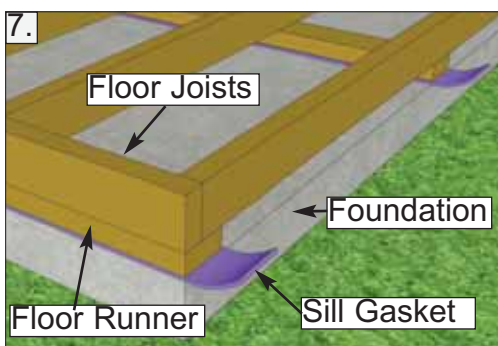
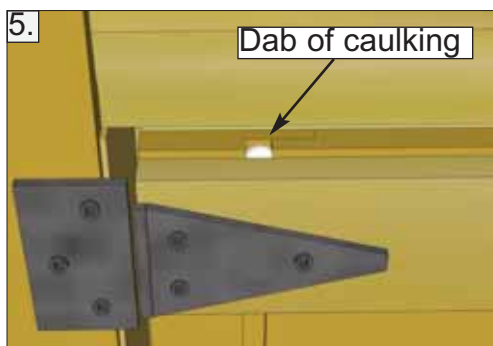
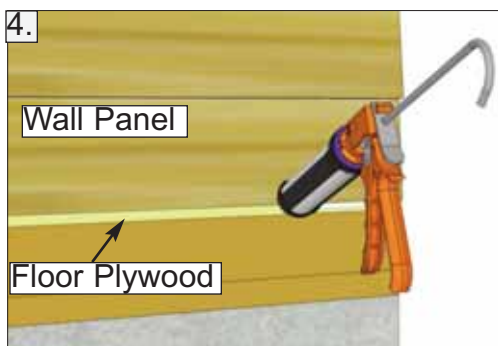
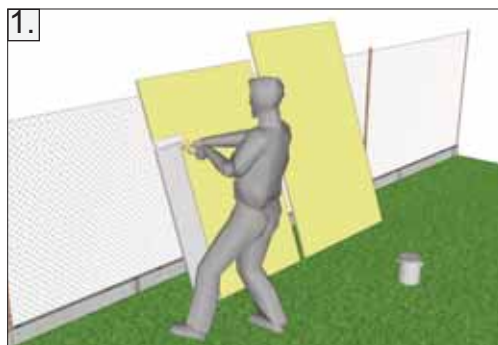

## Routine Maintenance:

- Routinely check all fasteners are tight (ex. Door Hinges, Nails)
- Brush off dirt from walls.
- Brush off snow from roof regularly.
- Routinely remove needles and leaves from roof.

## Painting/Staining

- Your cedar shed, if left untreated, will weather to a silvery grey color.
- Painting or staining your structure is highly recommended and will prolong the life of your shed.
- You do not need to wait to paint or stain your shed, the wood in your kit has been dried and can be stained or painted immediately.
- Consult your local paint store for the best paint or stain for cedar.
- Optional: stain the inside of your shed. (Note: this will remove the fresh cedar smell.)

# A. Floor Section

Exploded view of all parts necessary to complete Floor Section. Identify all parts prior to starting. Note: Floor Footprint is 96" wide x 45 1/2" deep.

## Exploded Floor Section

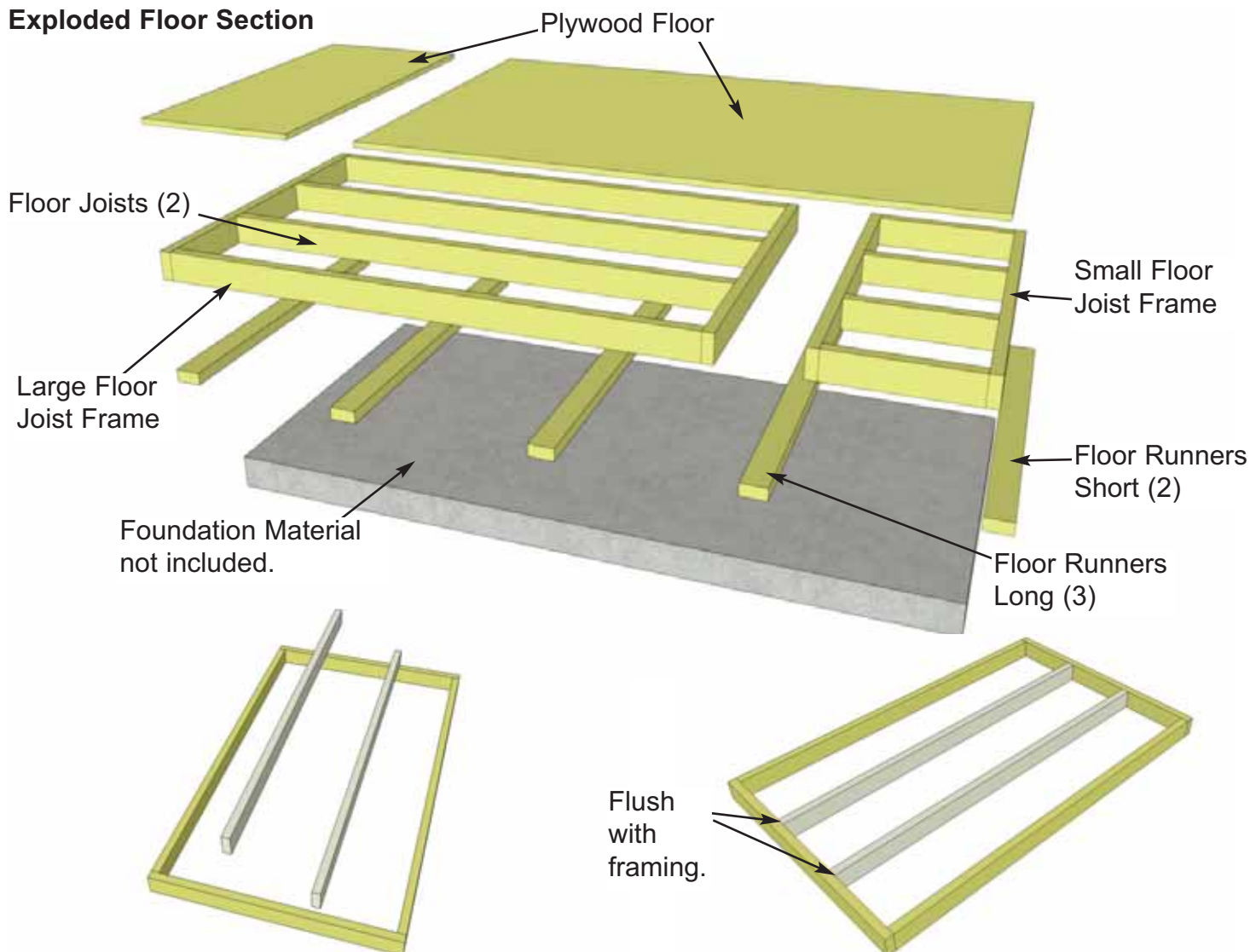

**1.** Lay out **Large Floor Joist Frame** and **2 Floor Joists** (1 1/2" x 3 1/2" x 71 7/8") as illustrated above. Position Joists equally in Floor Joist Frame. Use **Small Floor Joist Frame** as a template to determine joist position. Position Joist so flush with framing.

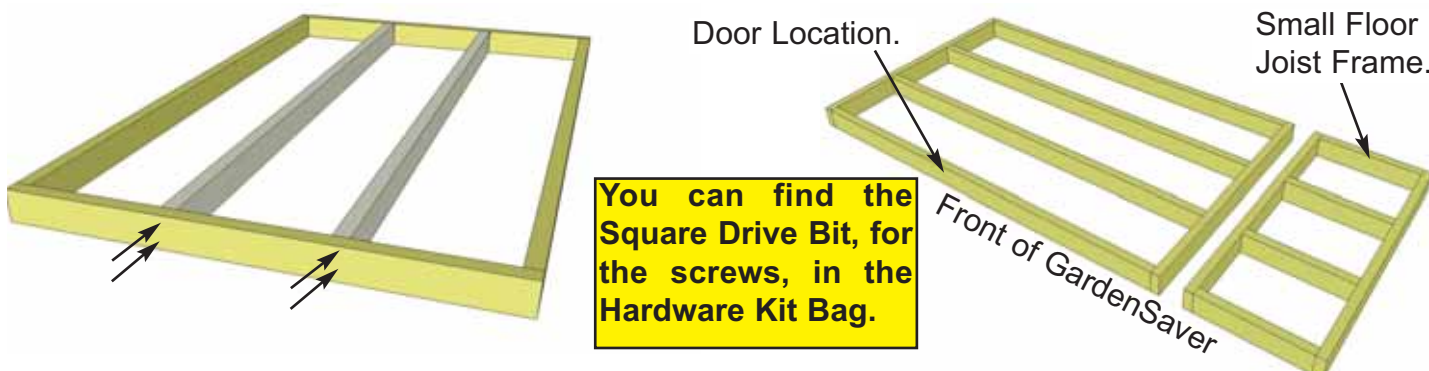

**2.** When correctly positioned, attach each Joist with **4 - 2 1/2" Screws (2 per end)**. You can find the Square Drive Bit for the screws in with the Hardware Kit Bag.

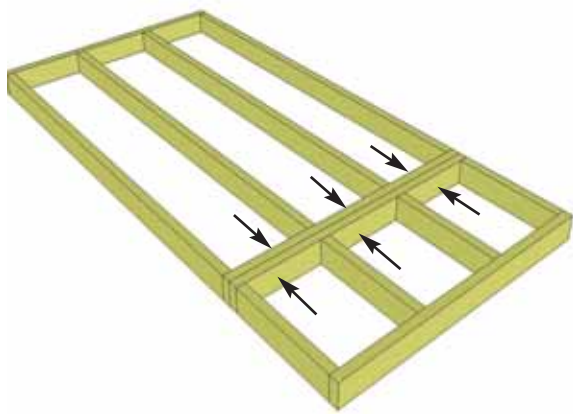

**3.** With Floor Joist Frames positioned together flush, attach with **6 - 2 1/2" Screws**.



**4.** Position and attach **Floor Runners Short** (1 1/2" x 3 1/2" x 45 1/2") on each side of the completed floor frame with **6 - 2 1/2" Screws** per Runner. Make sure Runners are flush with outside of floor framing but not overhanging.

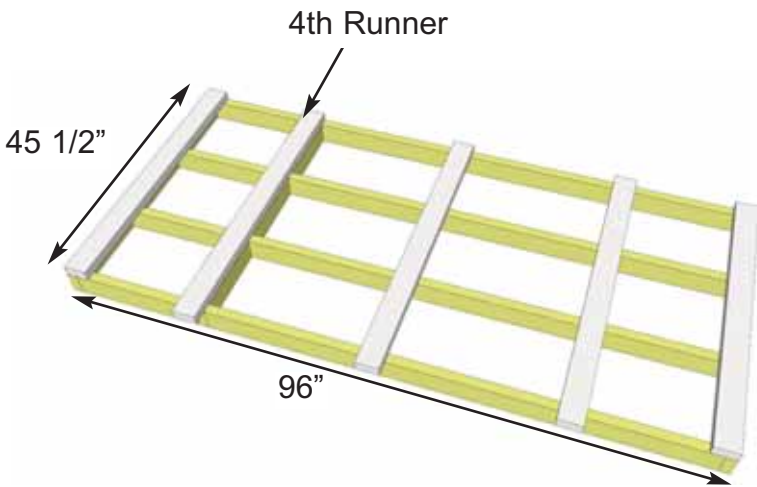

Floor Runners flush with Floor Frame on Back

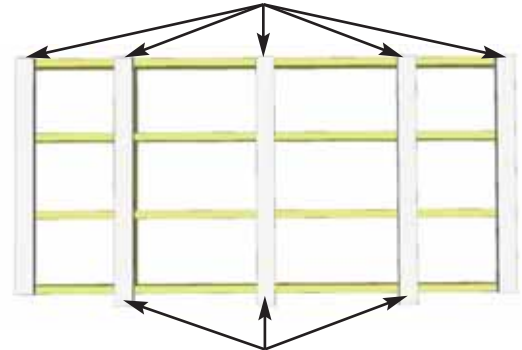

Long Floor Runners overhanging Floor Frame on front



**5.** Align **Floor Runners - Long** (1 1/2" x 3 1/2" x 47 3/4") evenly spaced as shown above and flush with the back of the Floor Frame. On the front, Runners will extend 2" past the Floor Frame to provide support for the Sliding Door Track later in the Assembly. Attach with **6 - 2 1/2" Screws** per Runner. Make sure 4th Runner is placed equally over seam where floor frames meet. With Floor Runners attached, carefully flip the floor over and place on your foundation. Caution - Be careful when laying floor down not to bend or twist floor. Note: Having a level foundation is critical. Choosing a foundation will vary between regions. Typical foundations can be concrete pads or patio stones positioned underneath the floor runners.

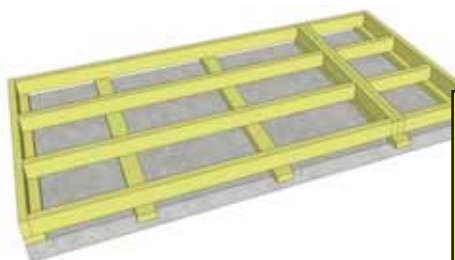

**Important:**  
Floor should be completely level before moving to next step.

**6.** When in place, level floor completely before proceeding.

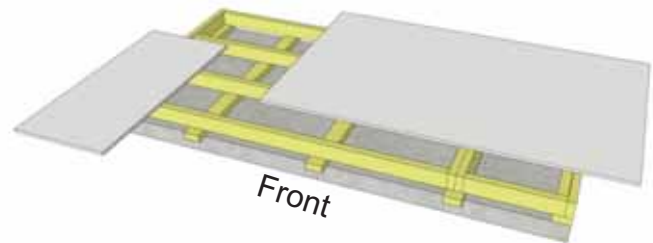

**7.** Position **Plywood Floor** pieces (2) on top of completed floor joists.



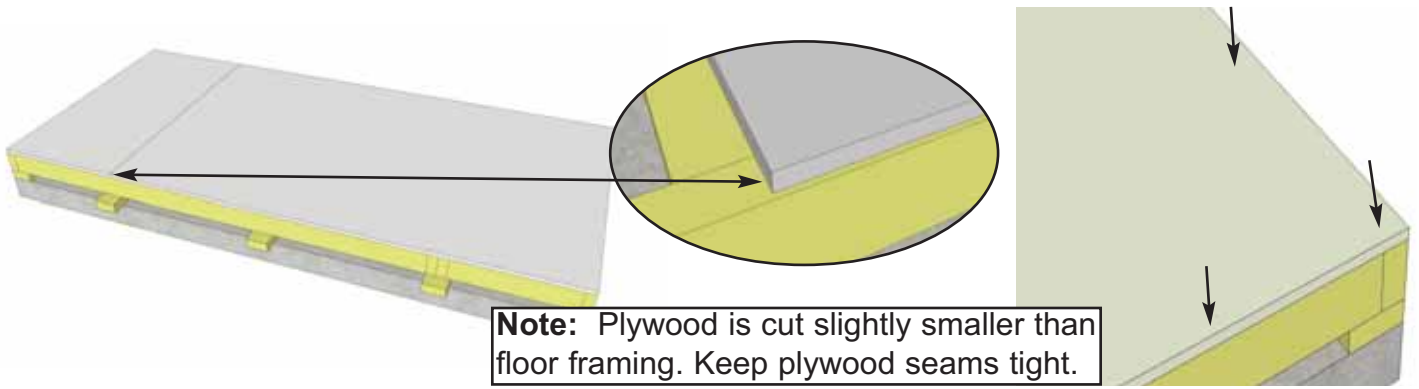

**8.** Position Plywood so it sits almost flush with outside of floor joist framing (see **Note**). When correctly positioned, attach to all floor joists with approximately **24 - 1 1/4" Screws**. Use screws every 16".

## B. Wall Section

Exploded view of all parts necessary to complete the Wall Section. Identify all parts prior to starting.

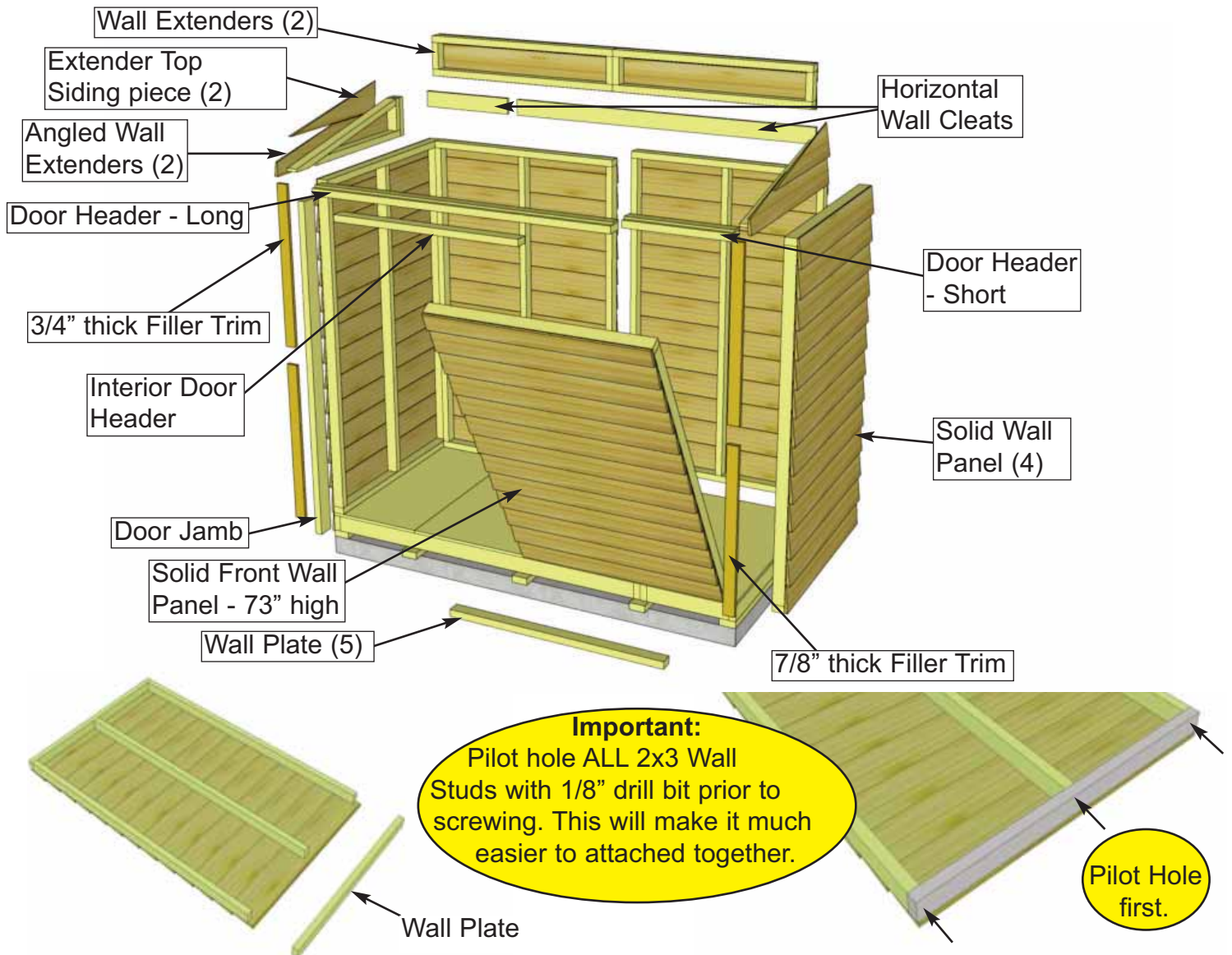

**9.** Locate 5 **Solid Wall Panels** and 5 **Wall Plates** (1 1/2" x 2 1/2" x 45 1/2"). Attach Plates to bottom of studs of each wall panel with **3 - 2 1/2" Screws**. Position so plates are flush with framing.

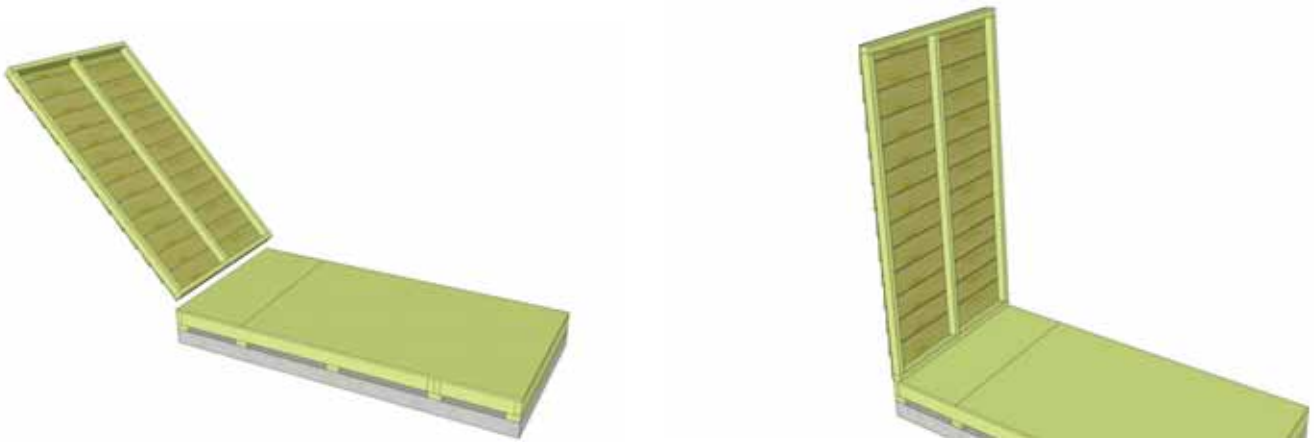

**10.** Starting on side, position a **Solid Wall Panel** on top of plywood floor. The Wall Panel bottom framing will sit flush with floor framing. Wall siding will overhang the floor. **Important:** Make sure all walls are aligned in their upright position. If not, water may leak into your shed. Unsure if panel is facing up or down? Recently attached Bottom Plate is on bottom of panel.

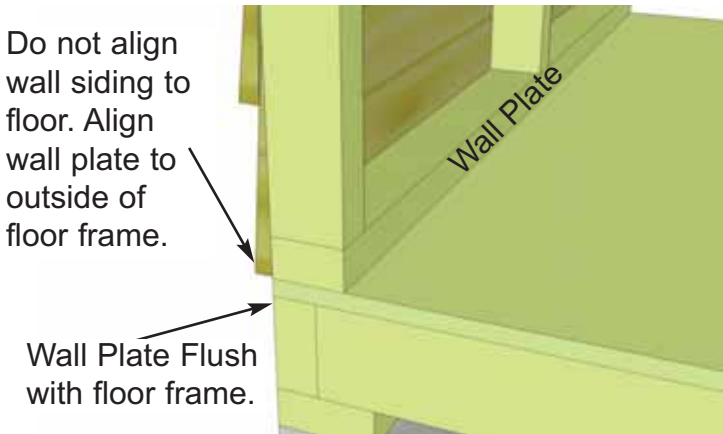

Do not align wall siding to floor. Align wall plate to outside of floor frame.

Wall Plate Flush with floor frame.



**11.** Outside 2x3 framing of wall panel should be flush with outside of floor framing when properly aligned. **Note:** Do not align wall siding to floor. Align wall plate to outside of plywood floor. When positioned correctly, locate 2nd Solid Wall Panel and place in corner.

**Do Not Attach Walls To Floor until Step 30.**

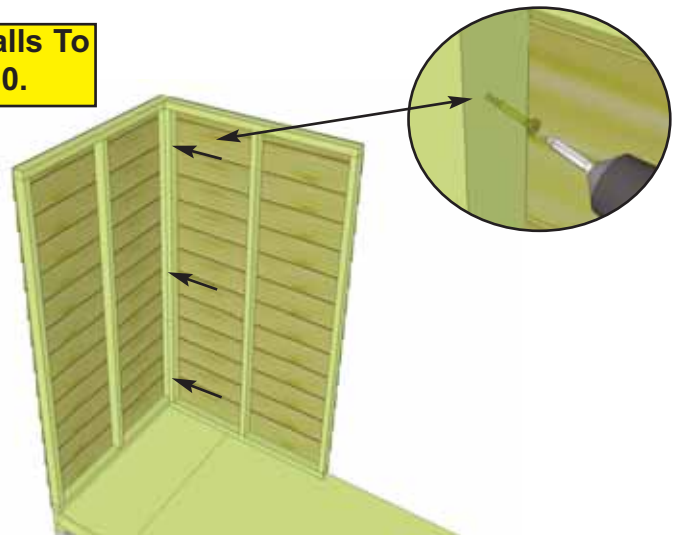
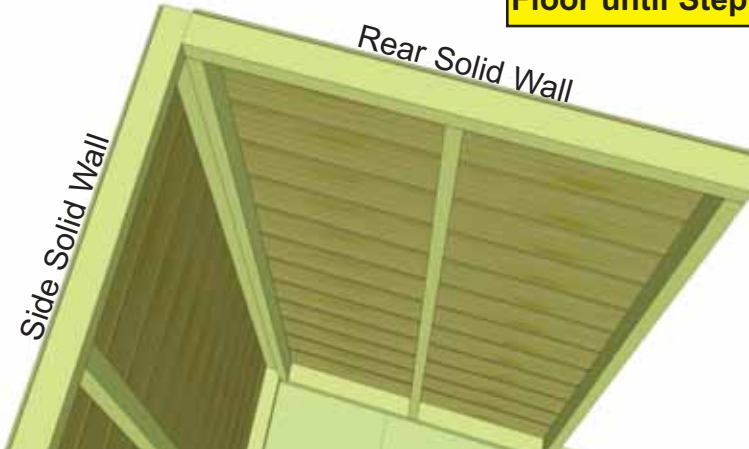

**12.** Butt both vertical wall studs of side and rear walls together and attach with **3 - 2 1/2" Screws**. Screw at the bottom, middle and top of stud to secure properly. Have helper push wall framing together while securing to ensure tight fit.



**13.** With the corner wall attachment complete, position the second rear wall panel in place so bottom 2x3 wall framing is sitting flush with outside floor framing. Wall siding should overhang floor by approximately 3/4". When positioned correctly, attach both wall panel studs together as per **Step 12** with **3 - 2 1/2" Screws**.



**14.** With Rear Wall Panel in place, position other side wall panel on floor as per **Step 10 & 11**.

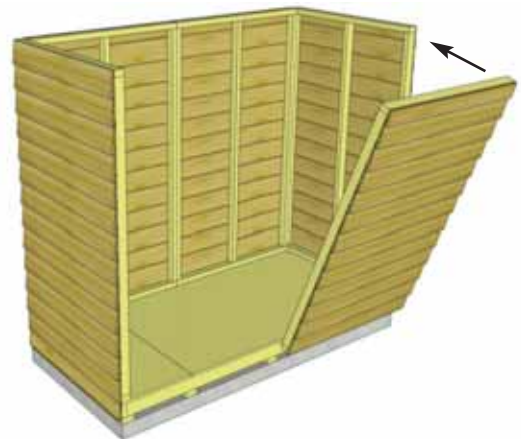
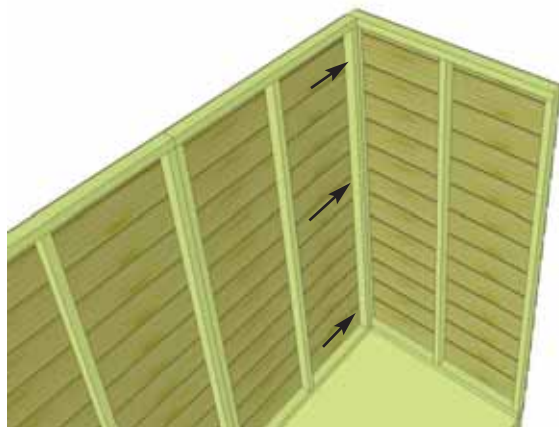

**15.** Secure side wall panel to rear wall panel as per **Step 12**. Next, locate the **Front Wall Panel (73" high)** and position in front right corner.

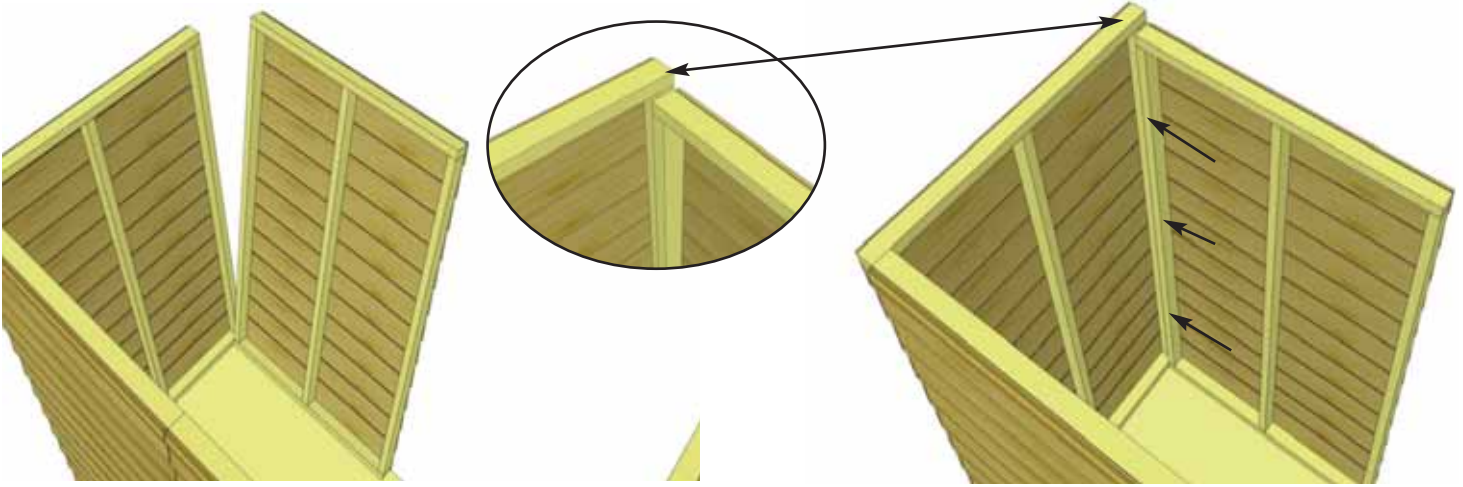

**16.** Once again position the 2x3 wall plate so it sits flush on floor and siding overhangs.  
**Note:** Front Wall Panel is only 73" high.

**17.** When correctly positioned, secure Front Wall Stud to Side Wall Stud with **3 - 2 1/2" Screws**.

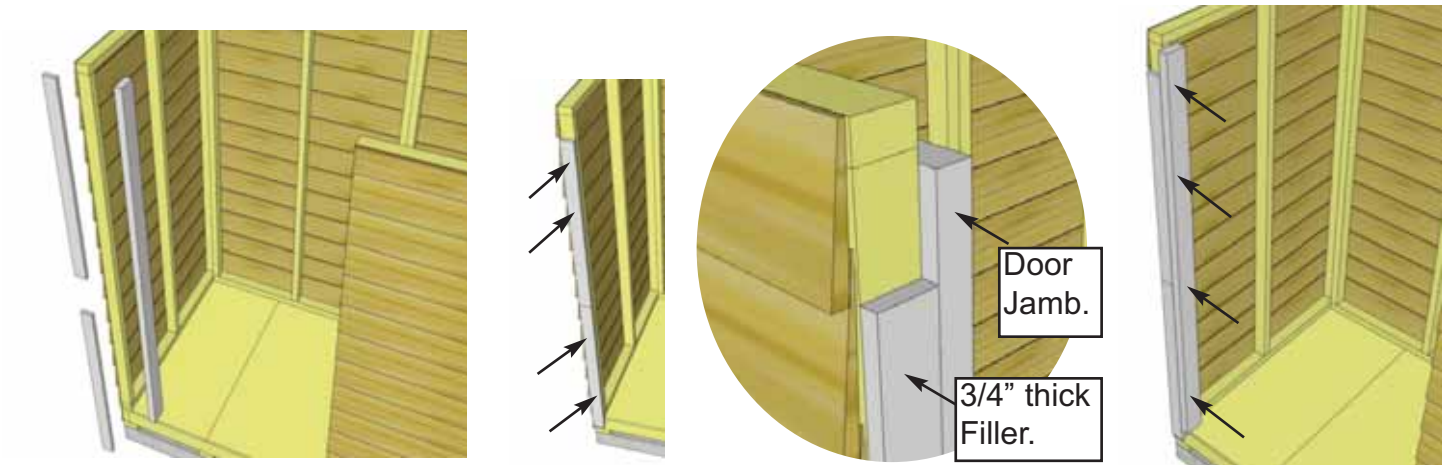

**18.** Locate **Front Left Corner Filler Trims** (2 @ 3/4" x 2 1/2" x 36") and **Door Jamb** (1 1/2" x 3 1/2" x 73"). Attach both Fillers with **4 - 1 1/2" Finishing Nails** as shown above. Place Door Jamb against inside wall stud and align with edge of filler. Attach Jamb with **4 - 2 1/2" Screws**.

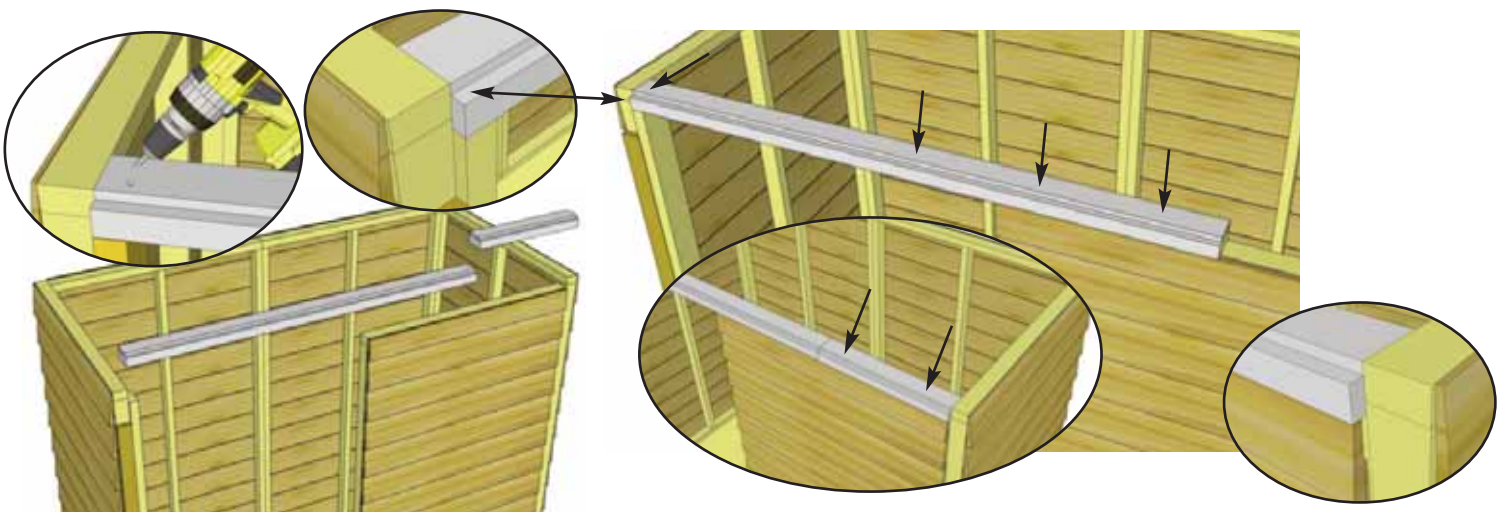

**19.** Locate both **Door Headers - Long and Short** (step facing up and out). Attach long header using **5 - 2 1/2" Screws**. Pre-drill left side and angle screw down. Line up header/filler/wall stud as shown above. Position and attach short header using **2 - 2 1/2" Screws** as shown above.

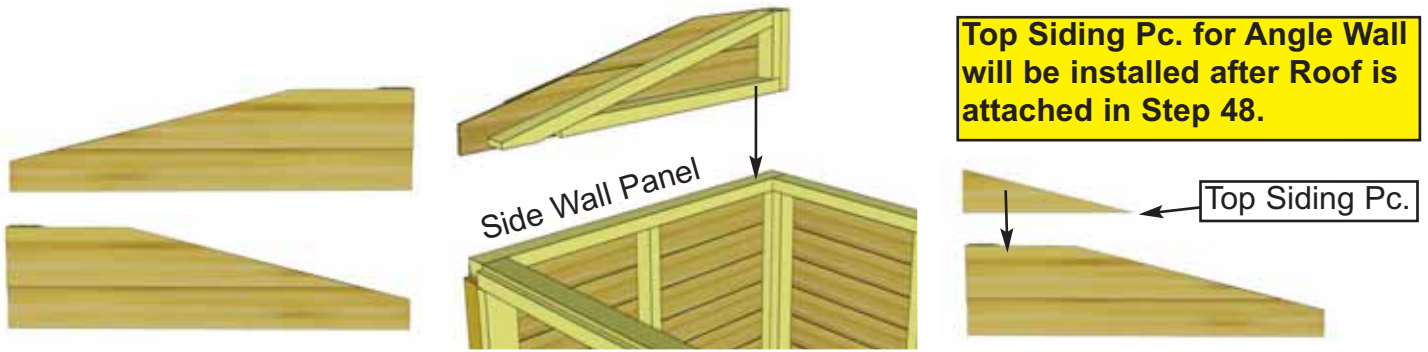

**20.** Locate both **Angled Wall Extenders (L/R)**. Place first wall extender on side wall panel frame.  
**Note:** Bottom siding of wall extender will overhang and cover siding of side wall.

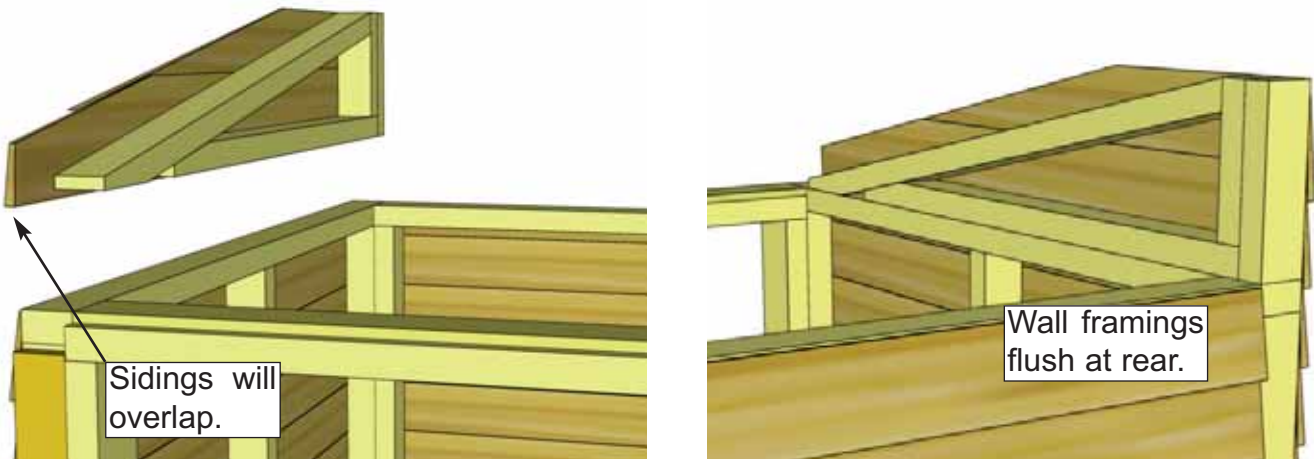

**21.** Align wall framing of Angled Wall Extender and Side Wall so they are flush at the front. The siding for both walls should also align evenly from front to back.



**22.** With Angled Wall Extender and Side Wall aligned correctly, secure together from the inside with **4 - 2 1/2" Screws**.

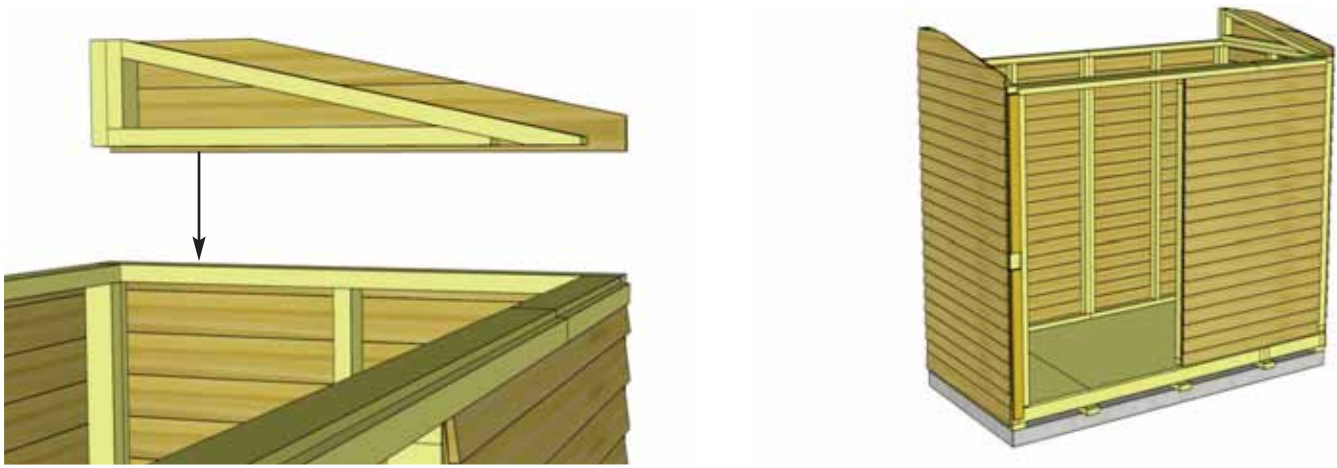

**23.** Complete opposite Angled Wall Extender positioning and attachment as per **Steps 21 & 22.**

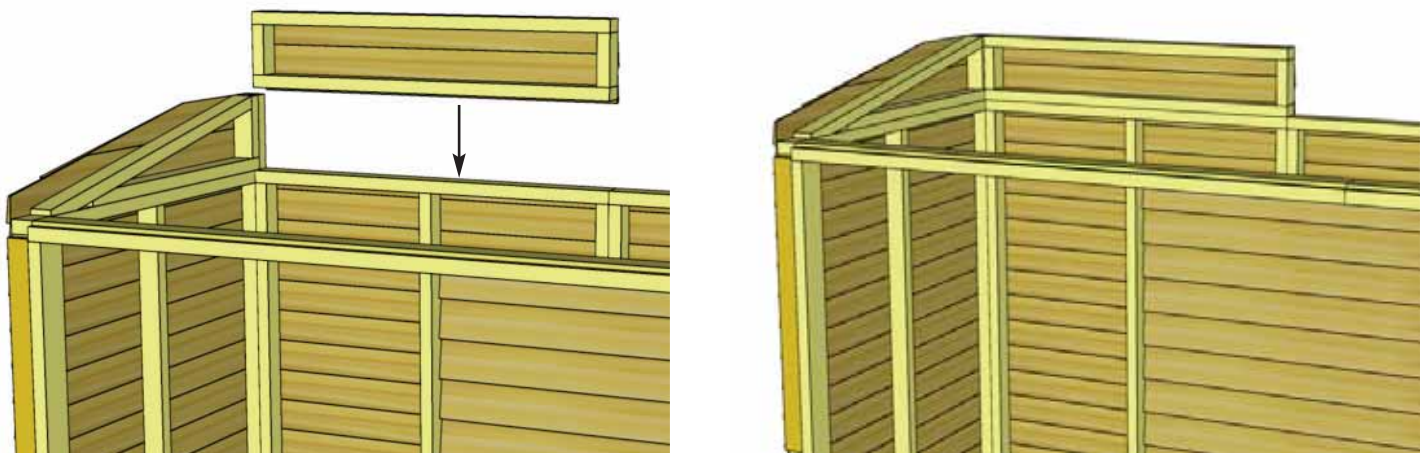

**24.** Locate one **Wall Extender** and place on Rear Walls with extender framing flush with inside edge of wall framing. Overhanging siding on front of extender will rest in notch of Header.

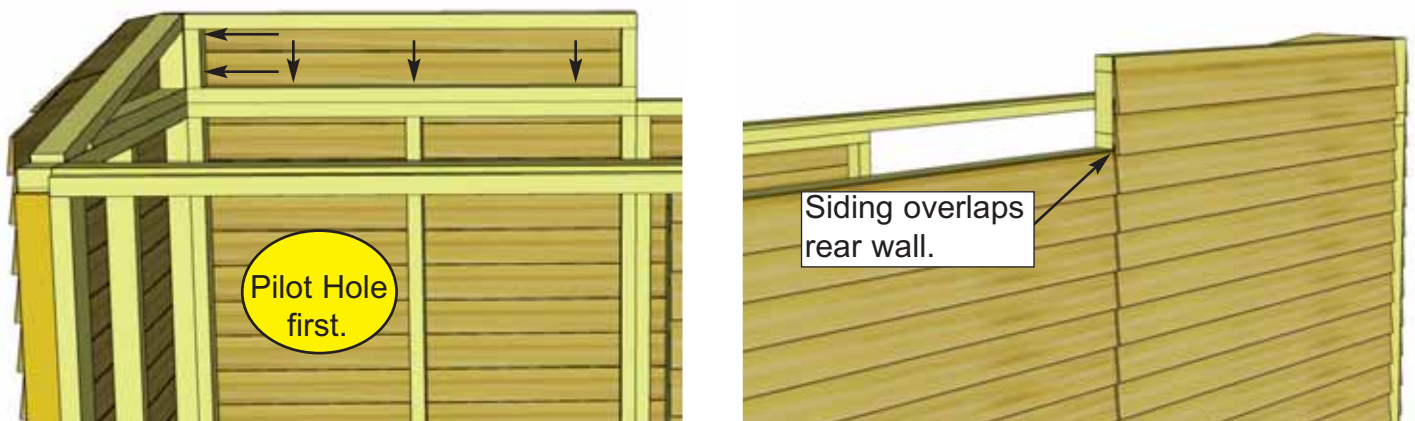

**25.** Attach Wall Extender to both the Angled Wall Extender framing and the Door Header with **5 - 2 1/2" Screws.**

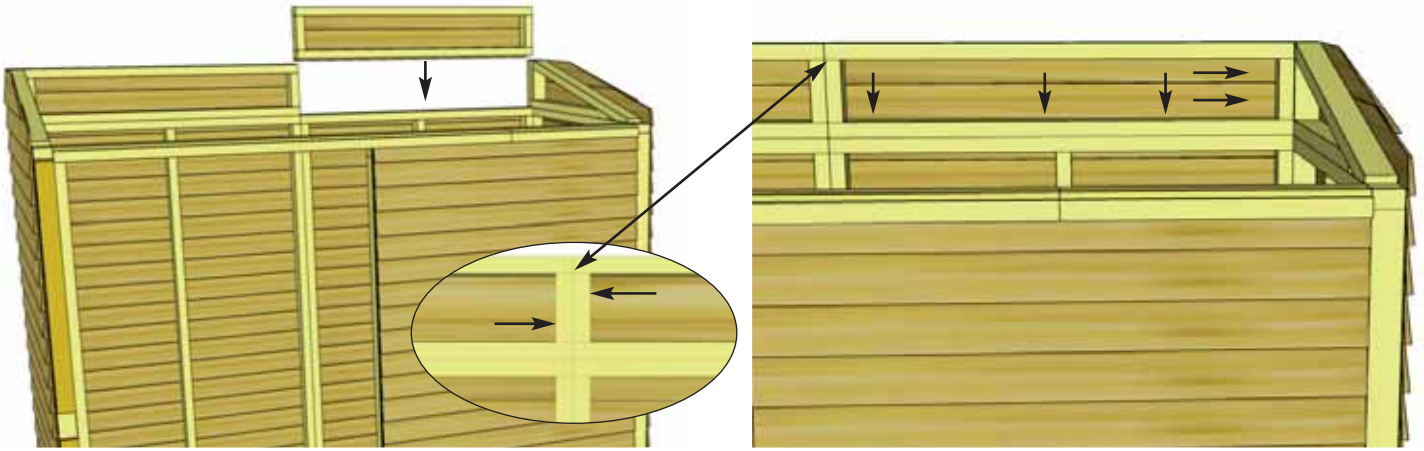

**26.** Position and secure 2nd Wall Extender Panel as per **Steps 24 & 25**. Additionally, attach to first Extender with **2 - 2 1/2" Screws**.

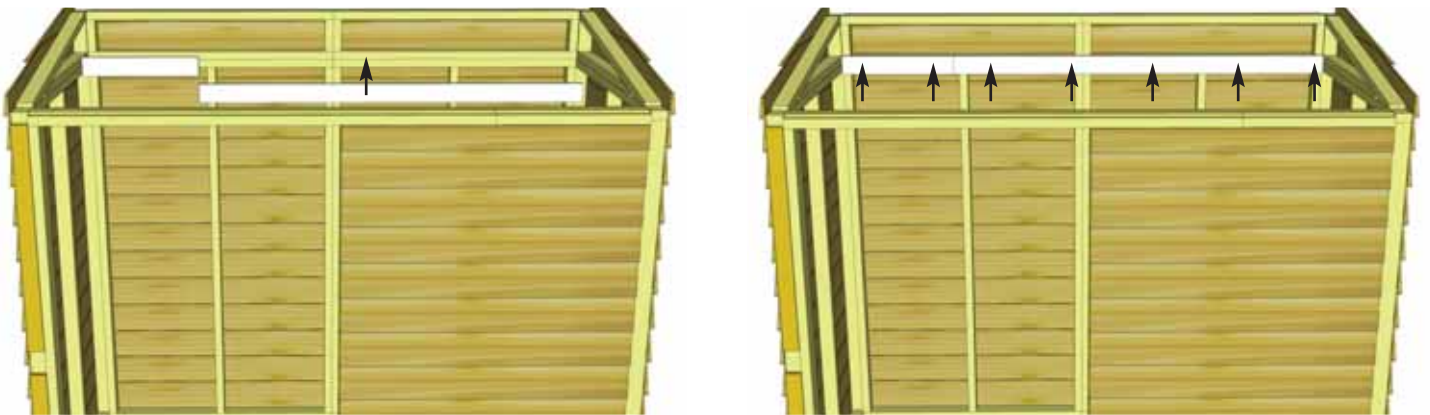

**27.** Align **Horizontal Wall Cleats** (1 @ 3/4" x 3 1/2" x 70", 1 @ 3/4" x 3 1/2" x 21") flush with top of Rear Wall framing. To help strengthen the Rear Walls, there is a short and a long wall cleat which meet off-center from the seam between walls. Attach Cleats with **8 - 1 1/4" Screws**.

**Advice:** Use Interior Door Header to confirm door opening is 44" wide.

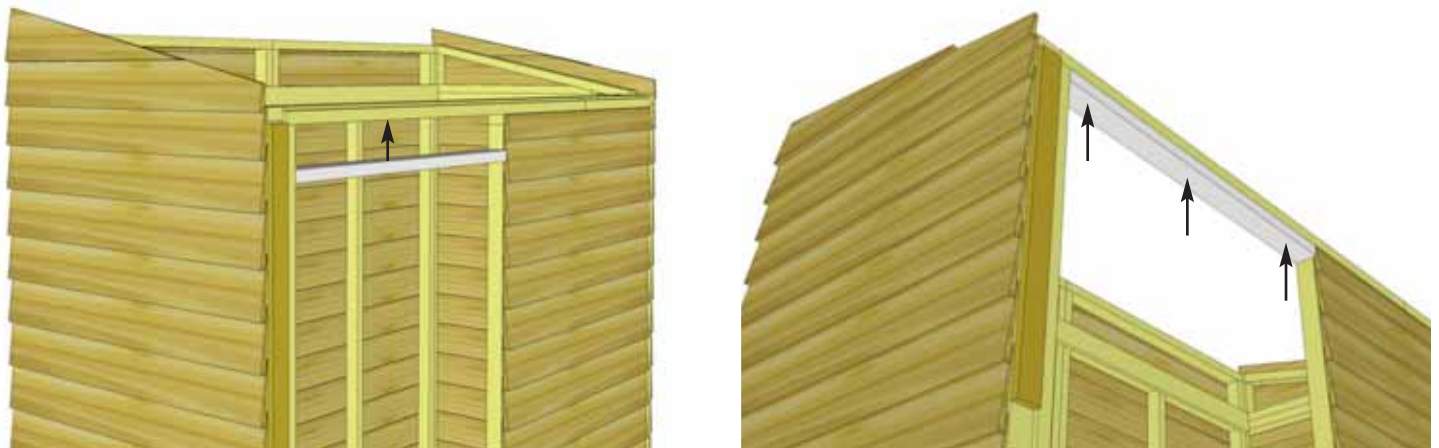

**28.** Align **Interior Door Header** (1 @ 1 1/2" x 2 1/2" x 44") flush with top of framing on front wall and underneath door header. Attach with **3 - 2 1/2" screws**.



**29.** Position and attach **Front Right Corner Filler Trims** (2 @ 7/8" x 2 1/2" x 36") with **4 - 1 1/2" Finishing Nails** per piece. Filler trims won't be visible because they serve as nailing strips for the Corner Trims which will be attached later.

**Advice:** Prior to fastening walls and installing rafters, take time to confirm your walls are level, square and plumb.

Measure diagonal at top and bottom of walls corner-to-corner. This should be approximately 99 1/4". More importantly, if measurements are not within 1/4", your walls are not square. Adjusting now will make it easier to install roof section.

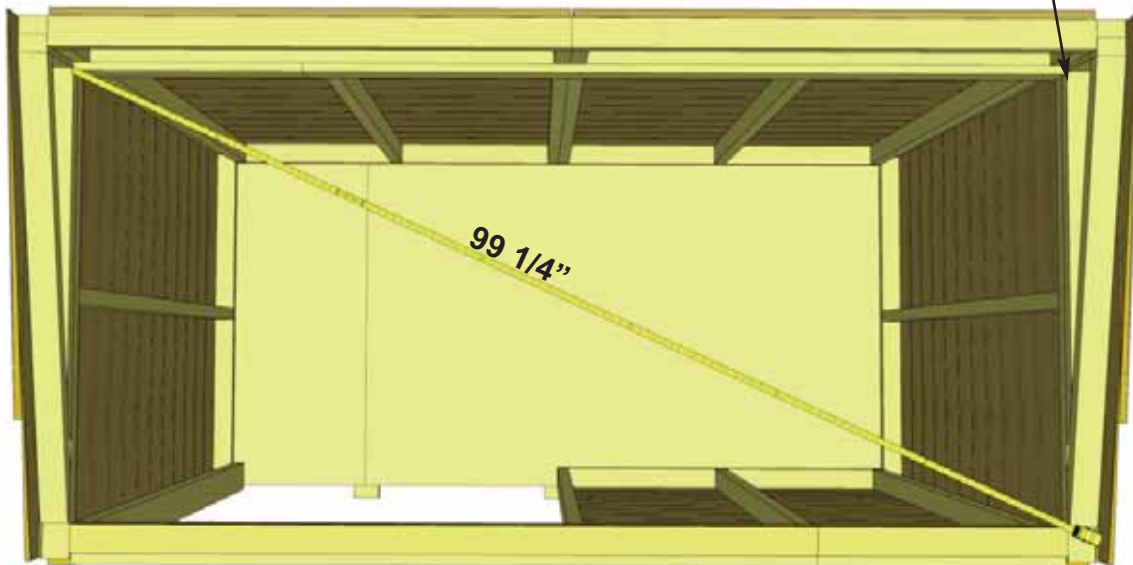
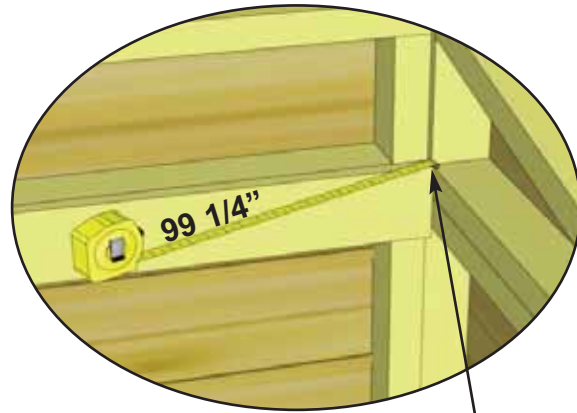



**30.** To complete Wall Section, attach bottom 2x3 wall plates to plywood floor with **20 - 2 1/2" Screws**. Confirm Doorway opening is 44" wide. Prior to securing, make sure wall panels are aligned correctly on the floor. Refer to **Step 11**. Wall siding should overhang floor while 2x3 wall plates should sit flush with floor.

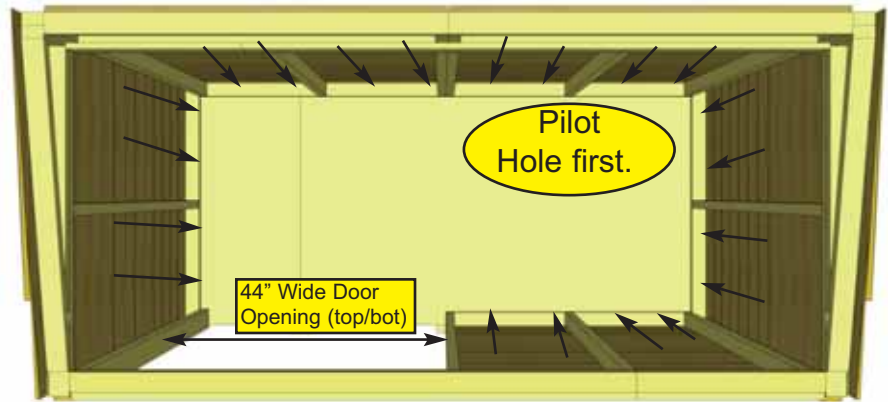

**Optional** - Caulking seams will help prevent moisture from entering at seam. Caulking not included in kit.



## C. Rafter and Roof Section

Exploded view of all parts necessary to complete the Rafter and Roof Section. Identify all parts prior to starting.

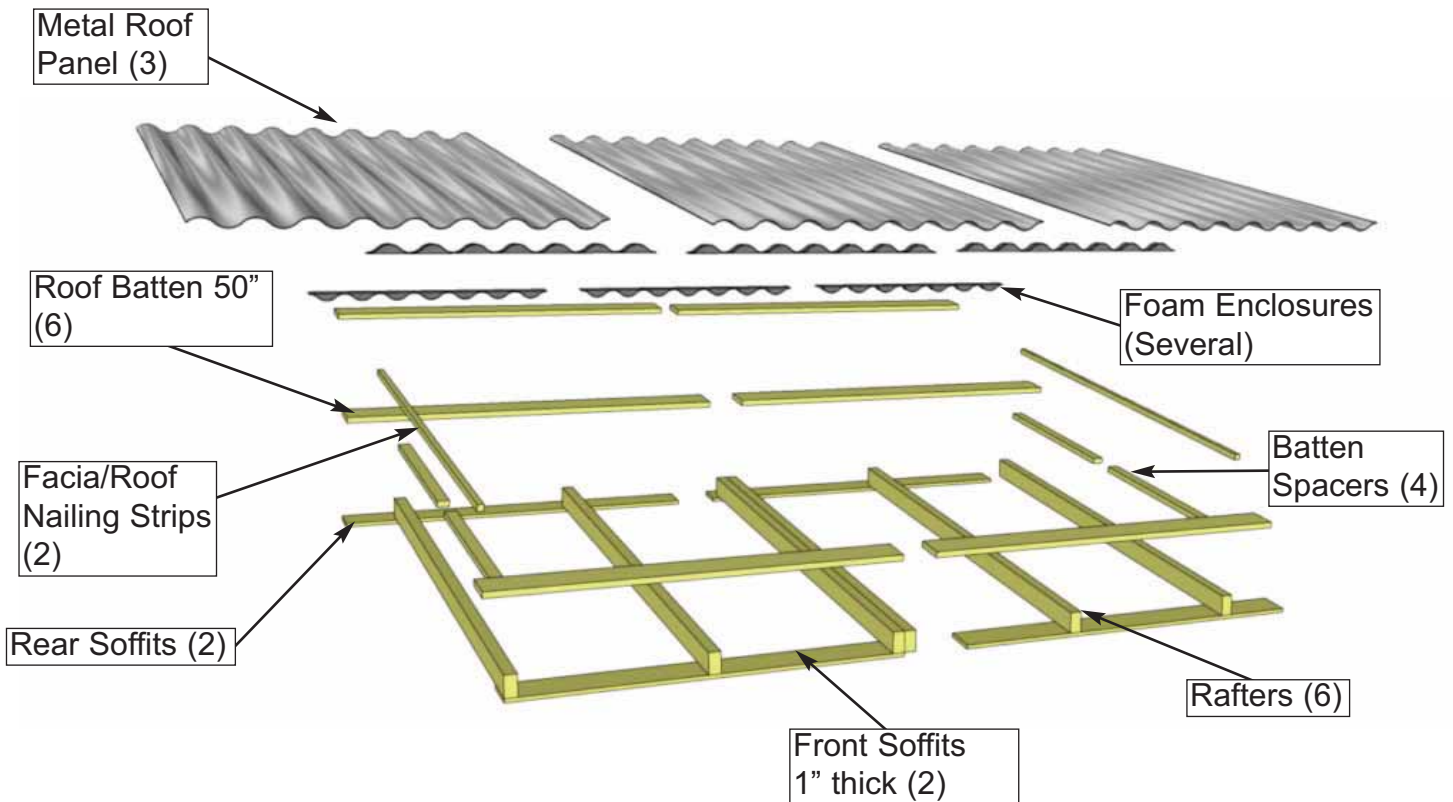

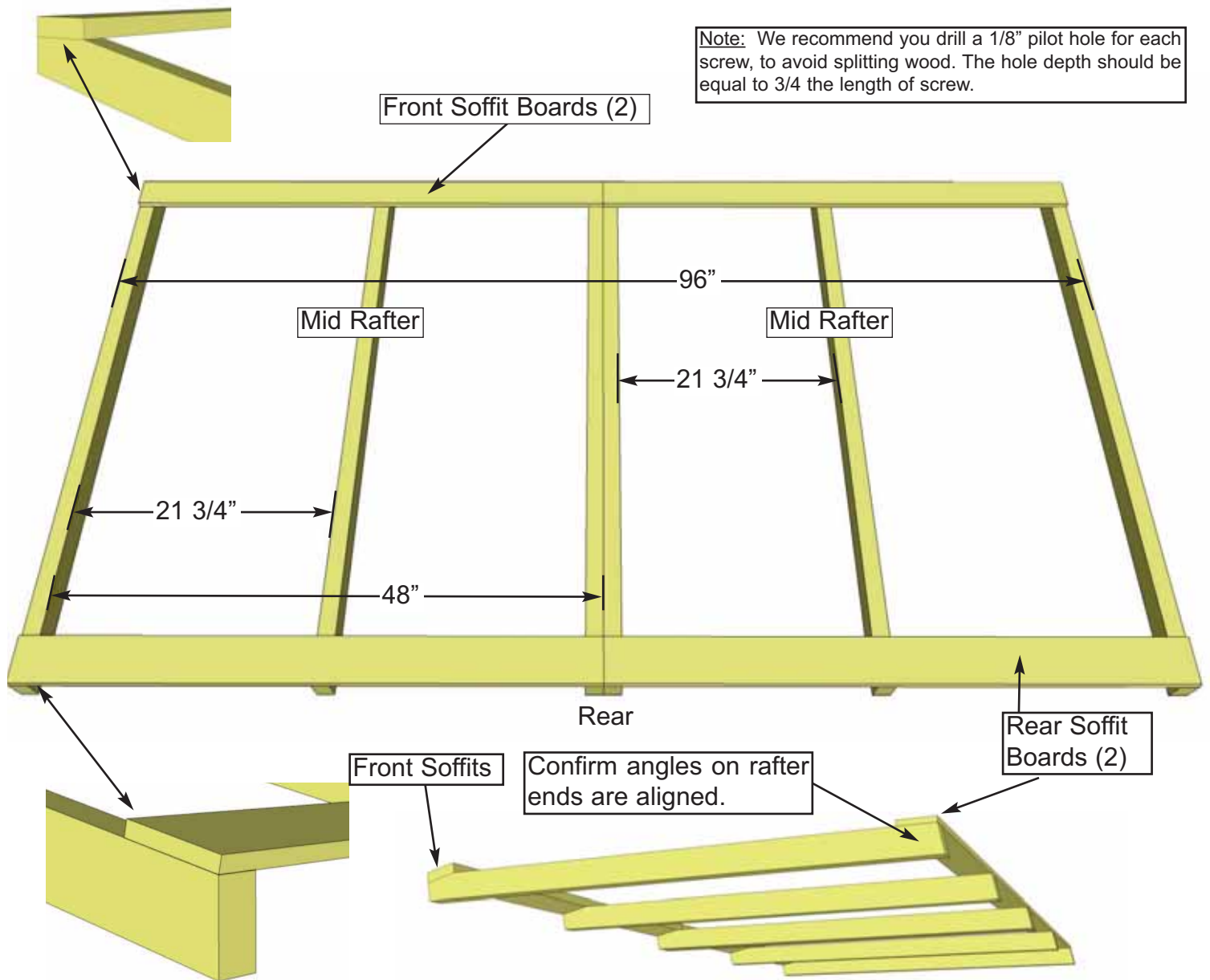

**31.** Locate 6 **Rafters**, 2 **Rear Soffits** and 2 **Front Soffits**. Lay out on level ground and assemble as shown in Illustrations **A** through **C** below. Attach Soffit Boards flush to end of outside rafters with 2 - 1 1/4" screws per rafter end. **Important:** Drill pilot holes in Soffit ends to prevent splitting. Measure and attach interior Rafters as illustrated above. Measure and attach remaining Soffit/Rafter connections using 2 - 1 1/4" screws per rafter/soffit.

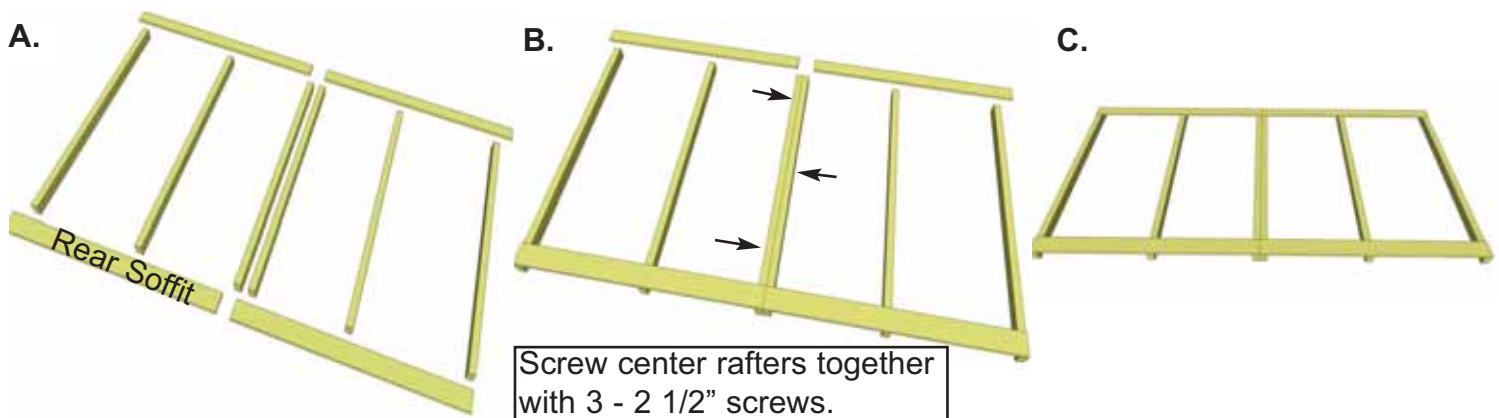

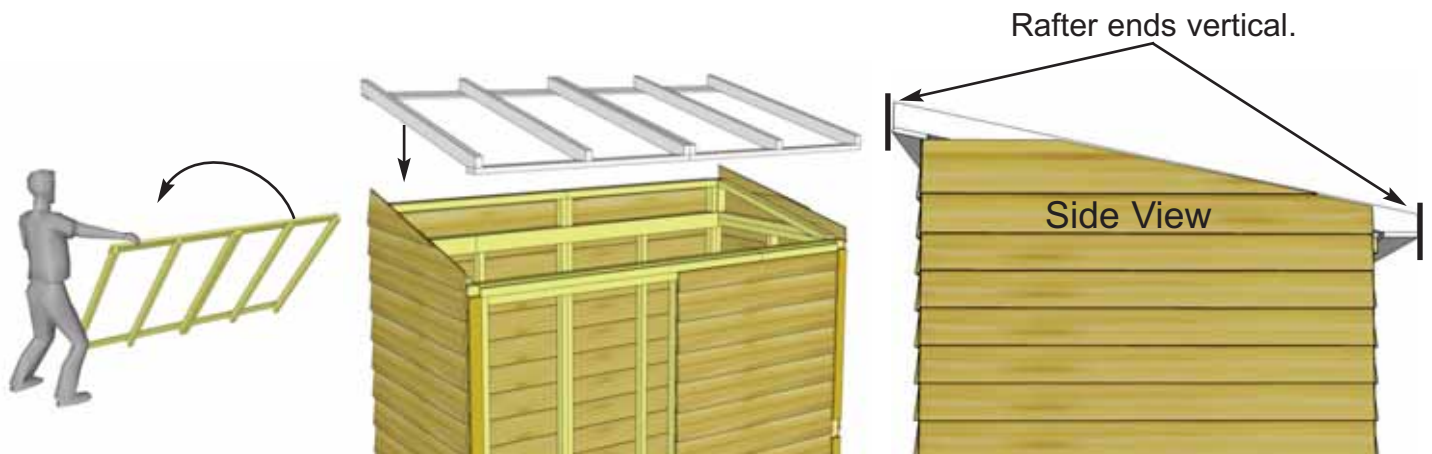

**32.** Carefully flip completed Rafter Section over so Front Soffit is facing the front and place on SpaceSaver walls. **Note:** Double check that your Rafter Section is positioned correctly by ensuring the ends of the Rafters are sloped vertically as shown above.

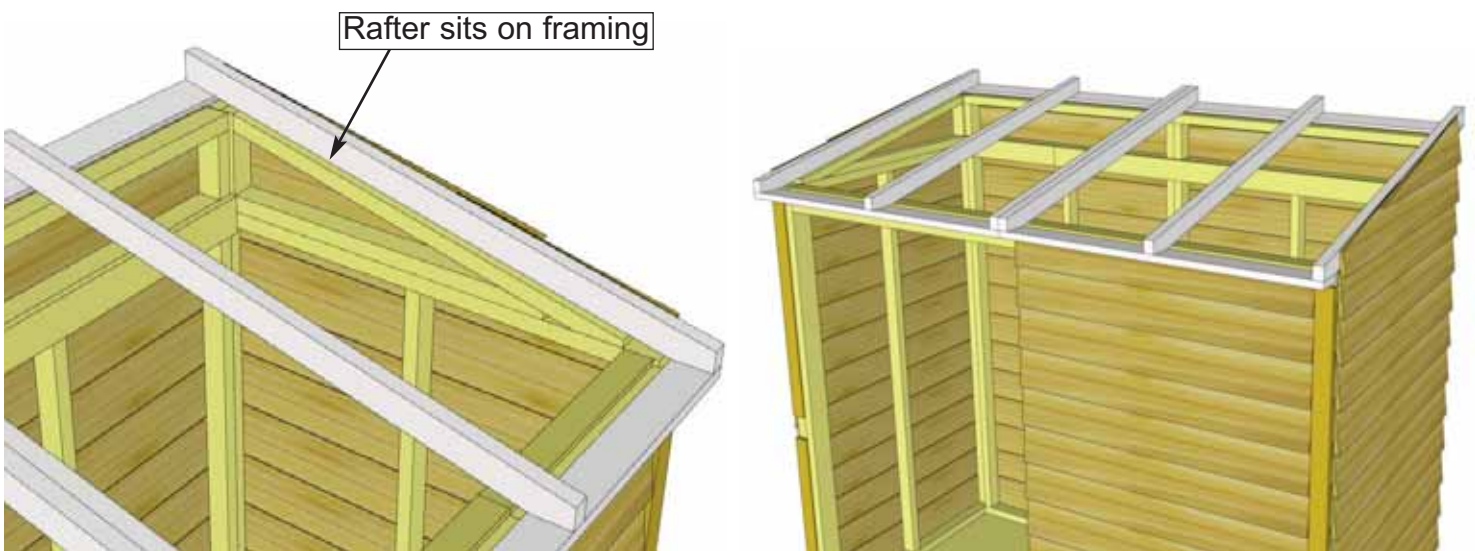

**33.** Position completed Rafter Section on top of walls. Outside Rafters will sit on Extension Wall framing and be positioned equally from side to side.

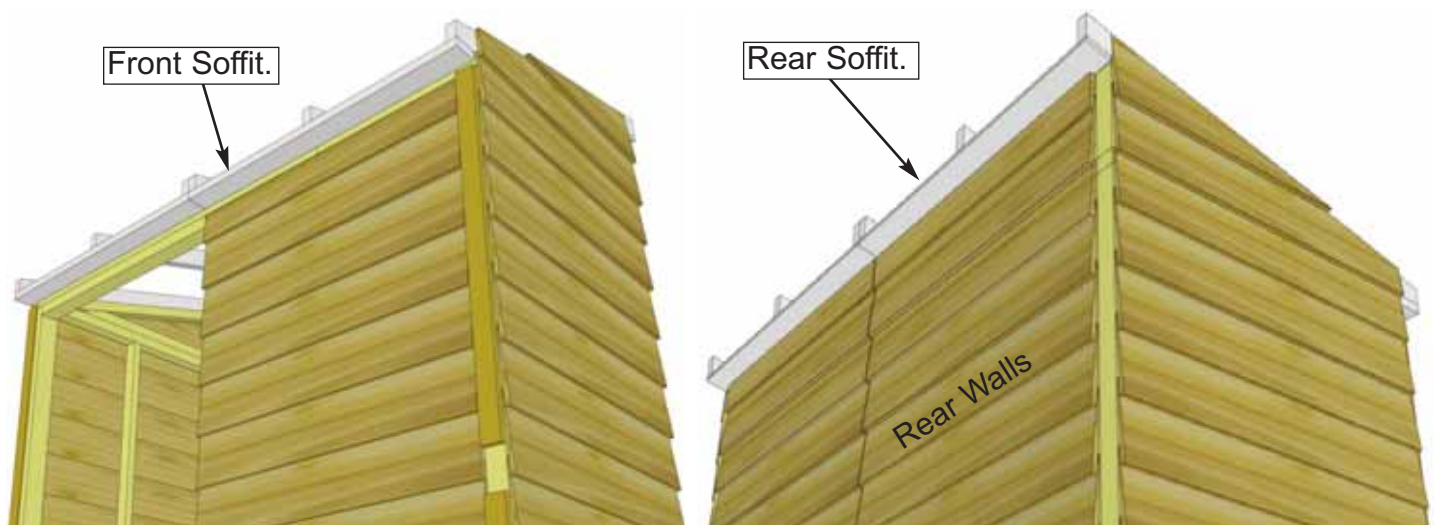

**34.** When Rafter Section is positioned correctly, both Front and Rear Soffits will sit approximately 1/8" away from wall siding. This can vary slightly.

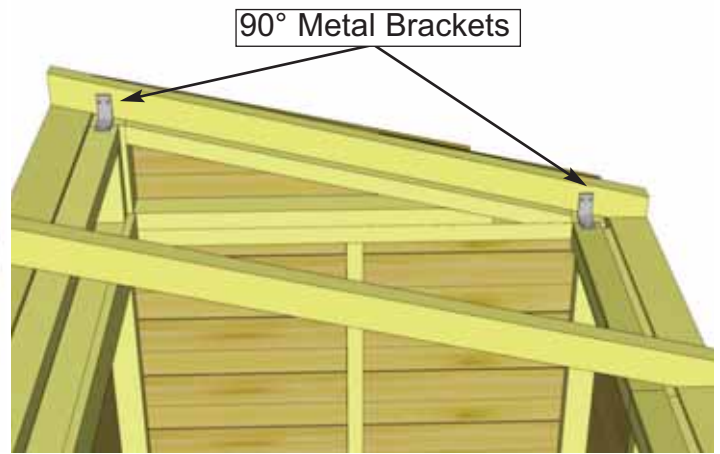
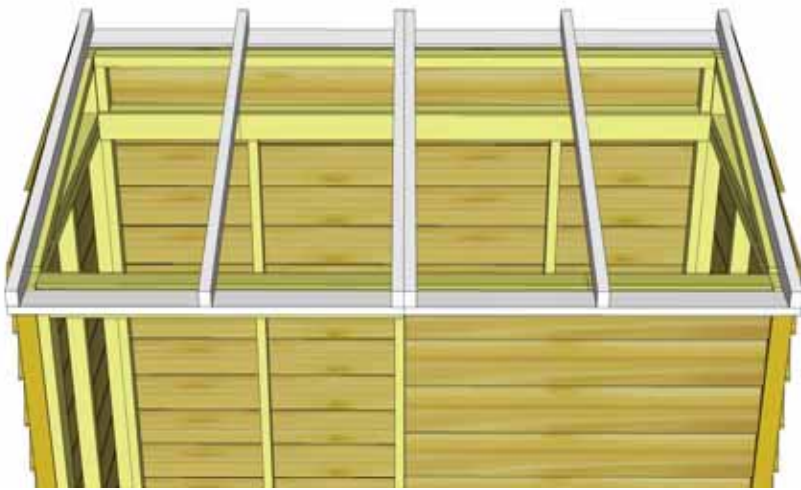

**35.** With Rafter Section correctly aligned, secure rafters to walls using **90° Metal Brackets**. Start with outside rafters and secure 2 Brackets with **4 - 1 1/4" Screws** per bracket. Screw into Wall Extension Framing at the front, and Wall Panel top framing at the rear. Complete both sides.

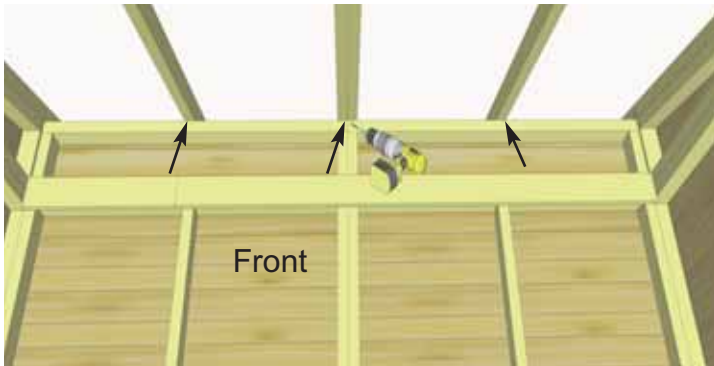

**36.** With outside rafters properly secured, completely secure remaining interior rafters using **8 - 3" Screws** (1 per rafter). Screw into rafters from inside of Door Header at front of shed and inside Extension Wall framing at rear of shed.

**Important:** Pre-drill Battens with 1/8" bit before fastening.

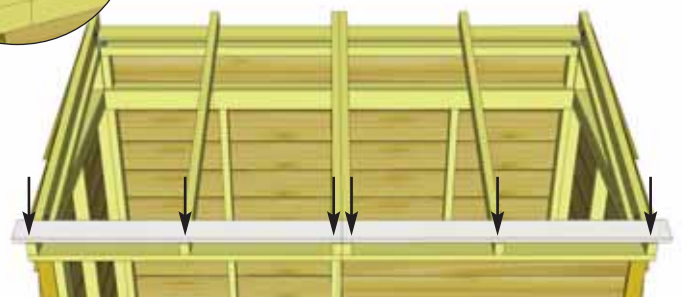
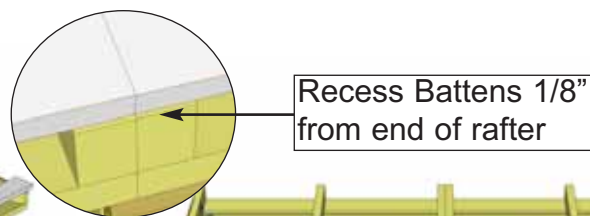

**37.** Position the first row of **Battens (3/4" thick x 3 1/2" wide" x 50")** on front of roof rafters. Recess battens 1/8" from rafter end. Batten will sit evenly on center rafters overhanging 2" on the outside rafters. Attach Batten with **1 - 1 1/4" screw** per rafter. Pre-drill with 1/8" bit first to prevent end from splitting. Fasten both 50" long roof battens.

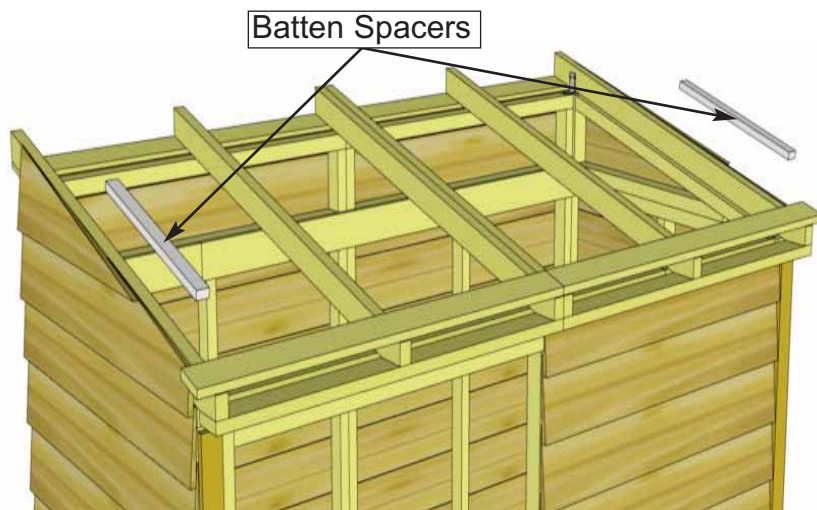

**Important:** Pre-drill Batten Spacers with 1/8" bit before fastening.

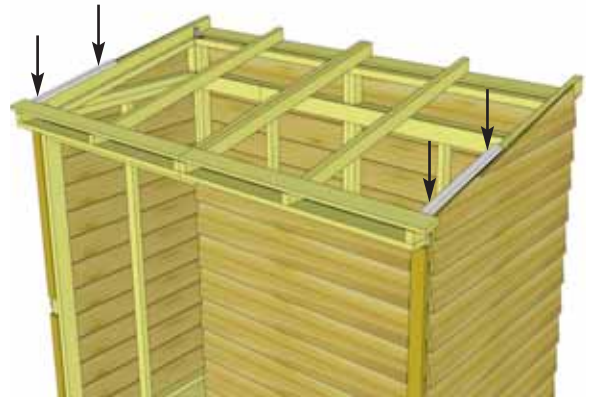

**38.** Place **Batten Spacers** (2pcs 3/4" x 1 1/2" x 21 1/2") above each attached Batten on outside Rafters. Ensure Batten Spacer is tight with Battens. Attach Batten Spacer to outside Rafter using **2 - 1 1/4" screws** per Batten Spacer.

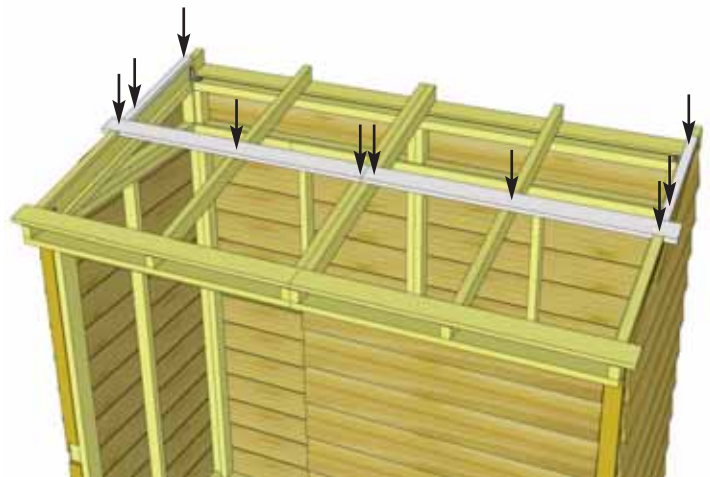
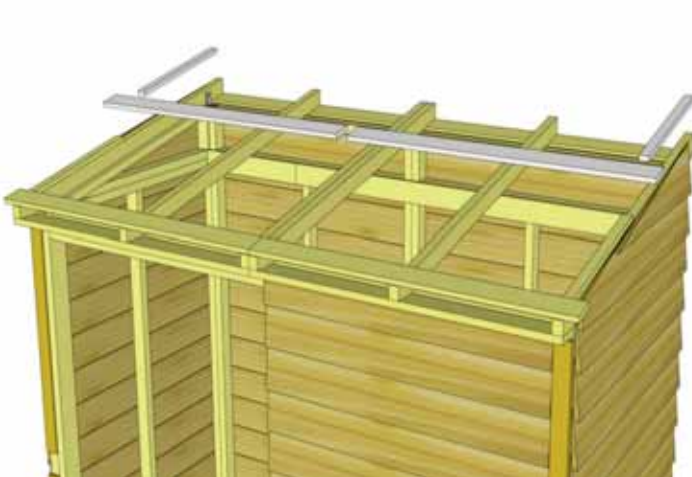

**39.** Locate Middle Row of Roof Battens (3/4" thick x 3 1/2" wide" x 50") position flush with previously attached Batten Spacers as per **Step 37**. Attach a second row of Batten Spacers flush with bottom edge of the middle battens as per **Step 38**.

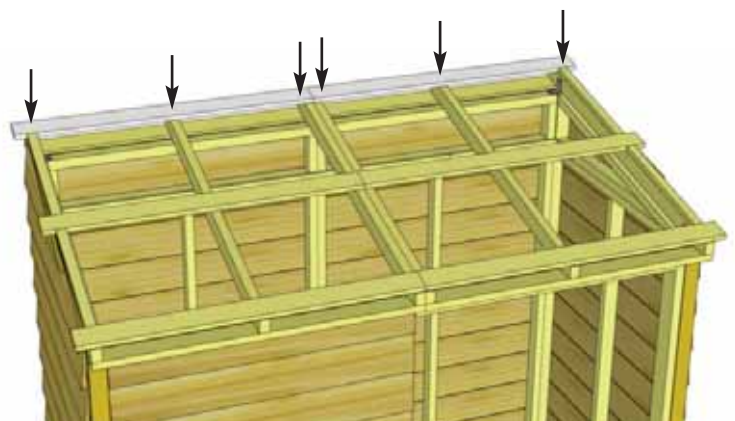
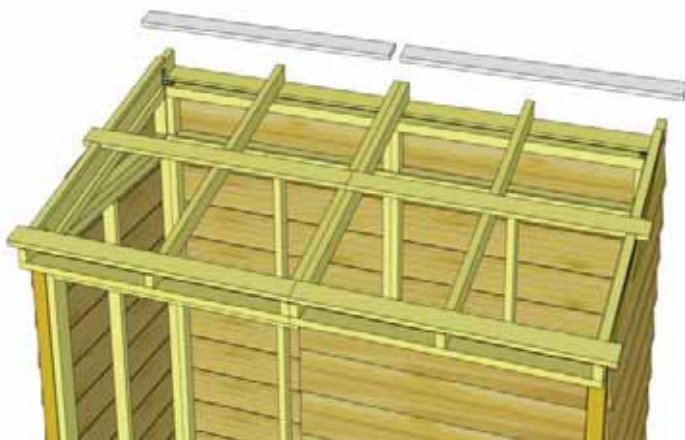

**40.** Locate final row of Roof Battens (3/4" thick x 3 1/2" wide" x 50") and attach flush with previously attached Batten Spacers as per **Step 37**, using a total of **6 - 1 1/4" screws**.

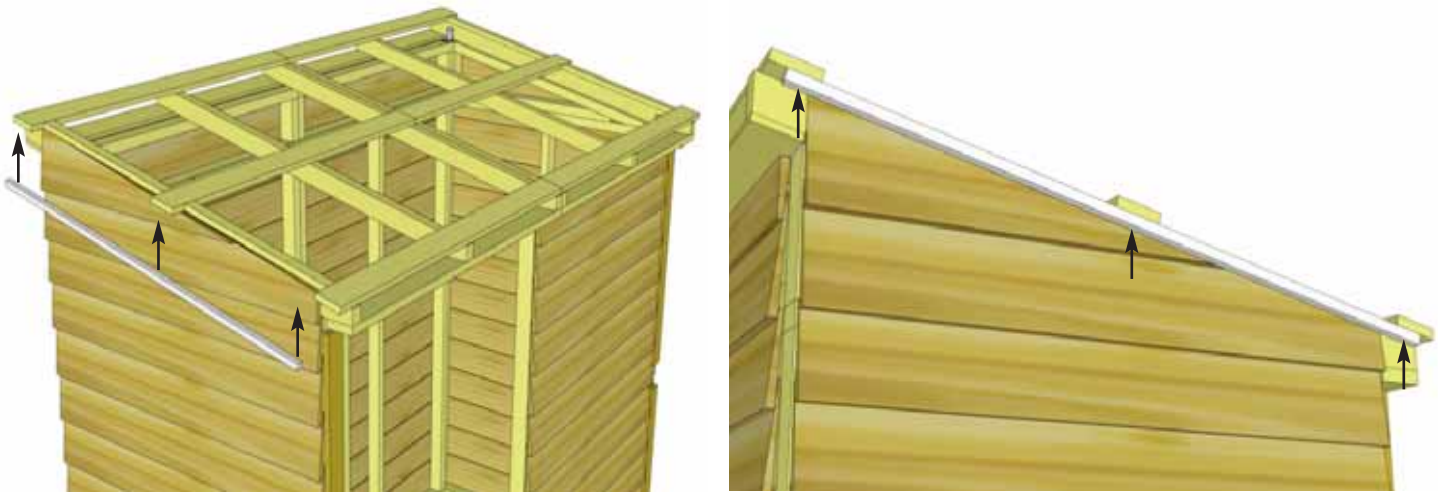

**41.** Center **Facia Nailing Strips (3/4" x 3/4" x 51")** underneath outside of each Batten. Attach with **3 - 1 1/4" screws** evenly spaced into the Batten. The Facia Nailing Strips provide a greater nailing surface later when attaching Side Facia.

Metal Roof Hangers will temporarily help keep Metal Roof Panels in place before they are fastened.

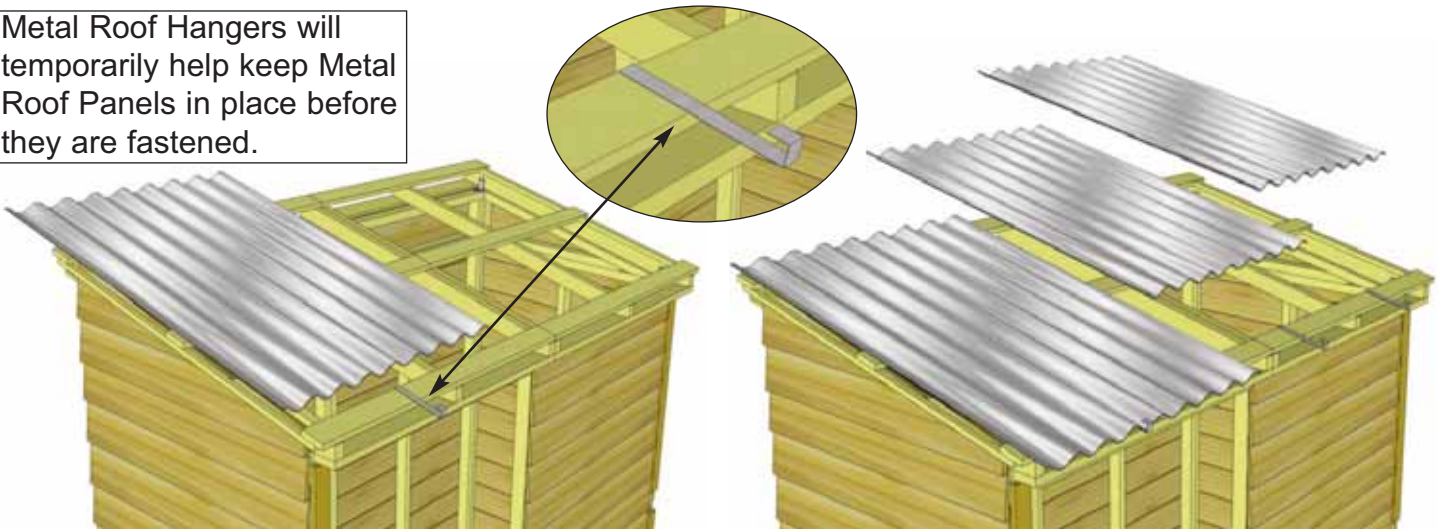

**42.** Locate **Metal Roof Hangers (3pcs)** and **Metal Roof Panels (3pcs - 39" wide x 58 1/2" long)**. To temporarily help hold Metal Roof Panels in place, hook a Metal Roof hanger onto the lower Batten approximately where the center of the first Panel will be. Place the first Metal Roof Panel on Battens. Do not fasten Panels down until **Steps 46 & 48**. Place other two Metal Roof Panels on roof in the same way.

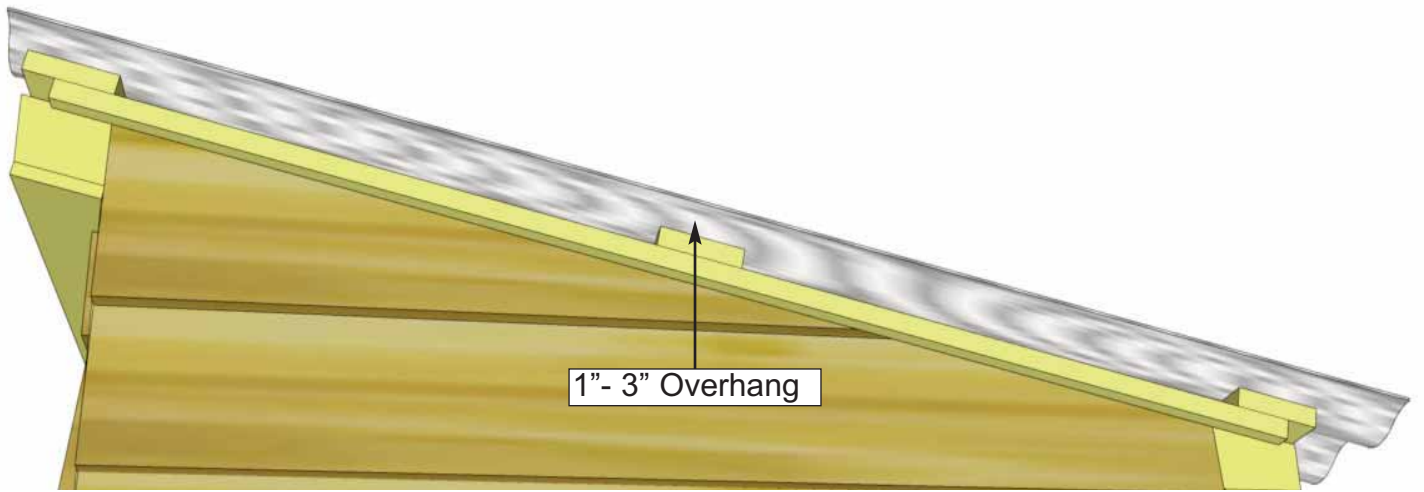

**43.** Overhang the **Metal Roof Panels** past the **Battens** on the sides by approximately 1" to 3", depending on your personal preference. The overhang on the front and rear will be set by the Metal Roof Hangers but should be approximately 1" at the rear and 4" at the front.

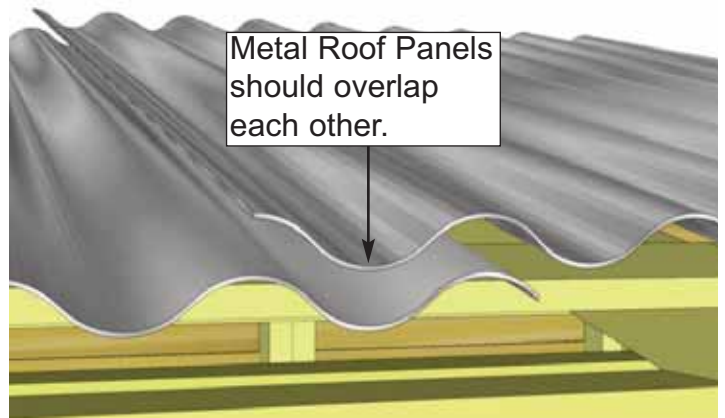
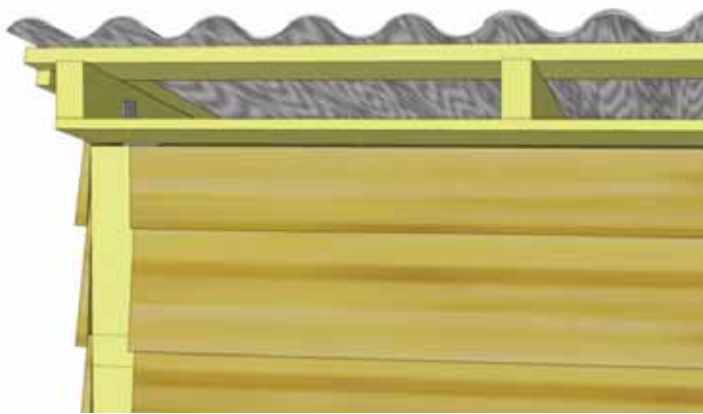

**44.** Adjust the position of remaining **Metal Roof Panels** on **Battens** as per **Step 43**. Overlap Metal Roof Panels to achieve desired overall width. Overall width past the end of Battens can vary from 1" to 3" depending on your personal preference.

Bead of Caulking

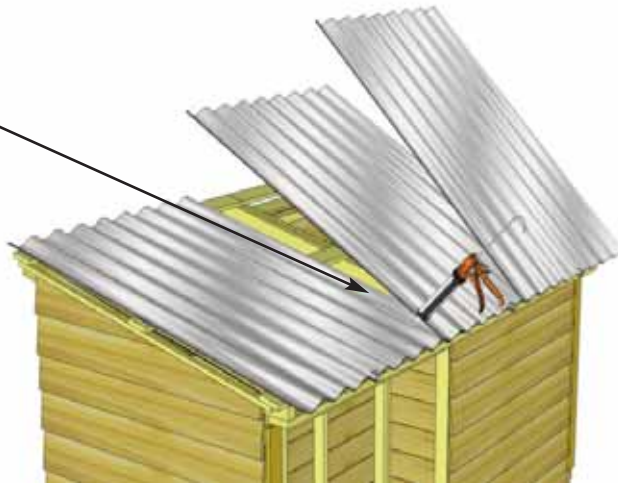

**45.** Once Metal Roof is spaced correctly from side-to-side and front-to-back, lift panels up and run a bead of caulking down the overlapping seams of each panel to seal the joints. You will likely need assistance from a helper for this step.

Attach middle row before removing Metal Roof Hangers. Screw into center of Battens.

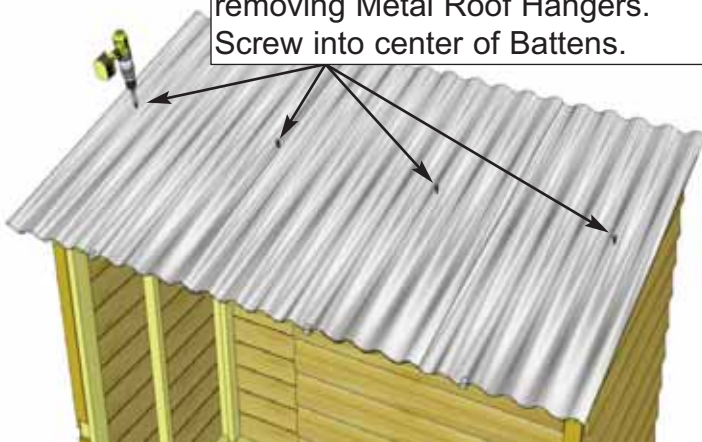

**Note:** Metal Roof hangers will be removed in **Step 47**

Screw into peak not valley.

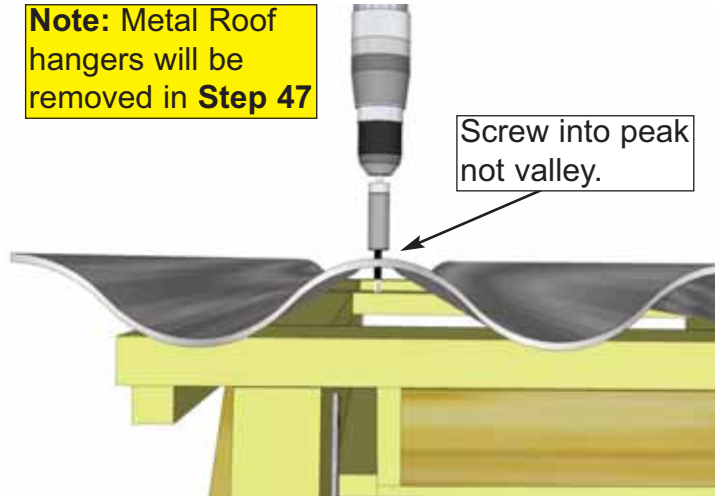

**46.** Using 4 - 2" Metal Roof Screws and 1/4" Nut Driver (included), secure Metal Roof Panels down to middle Batten row. Metal screw is self-tapping, do not overtighten. screw through roof panels into center of Batten.



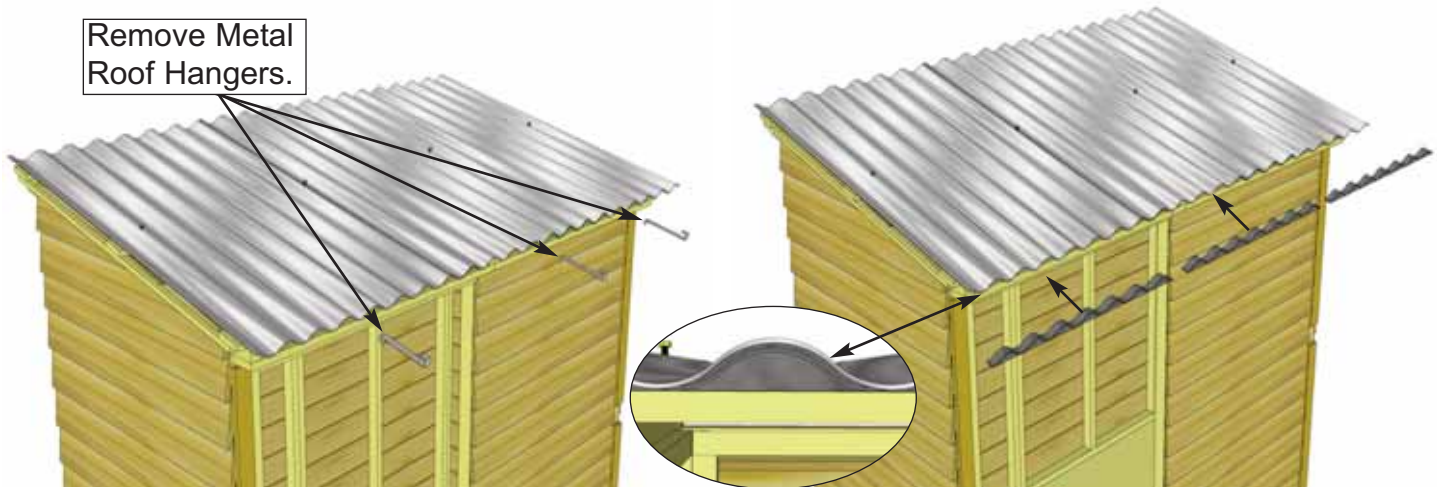

**47.** Remove the **Metal Roof Hangers** and insert 3 pieces of **Foam Enclosures** between Metal Roof Panels and Battens at the front. Enclosures may need to be snipped down in length to fit. Enclosures will prevent moisture and unwanted bugs, etc from entering your shed through here.

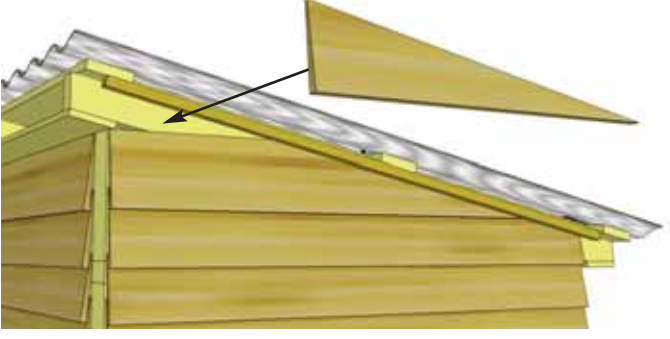
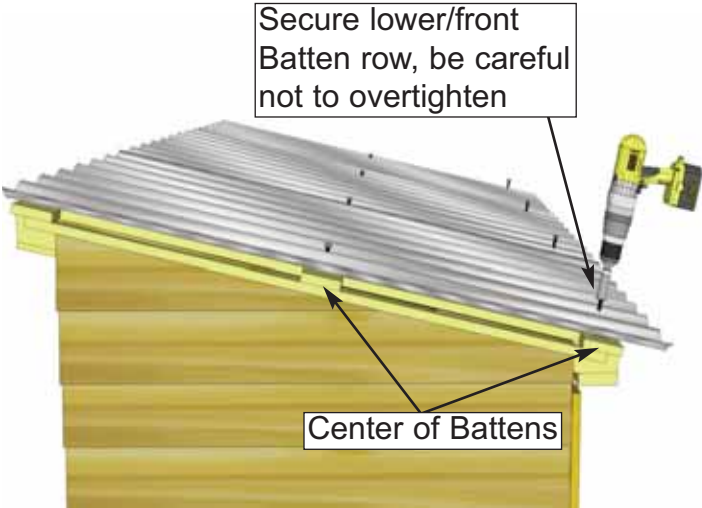

**48.** Using 4 - 2" **Metal Roof Screws** and 1/4" **Nut Driver**, secure **Metal Roof Panels** down to lower/front Battens. Metal screws are self-tapping, do not overtighten! Locate **Top Siding Piece for Angled Wall Extender (L/R)**. Position top siding on wall extender and align as shown above. Attach with 3 - 1 1/2" finishing nails to top wall framing. There are left/right top siding pieces. Use rough surface side out.

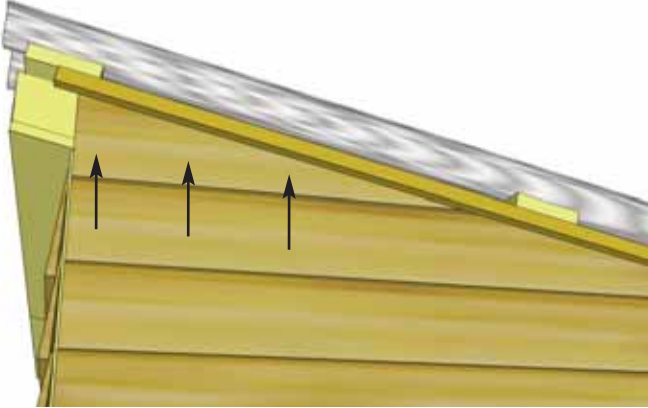

# D. Trim & Miscellaneous Section

Exploded view of all parts necessary to complete the Skirting, Trim, Facia and Miscellaneous Pieces. Identify all parts prior to starting.

(Not Shown: Rear Facia, Rear Middle Trim)

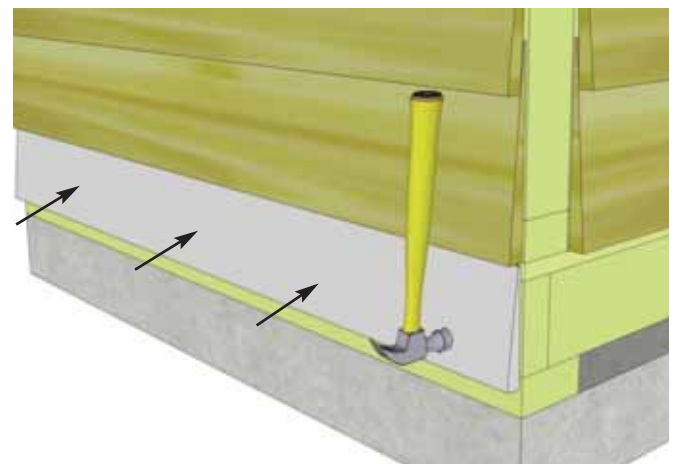
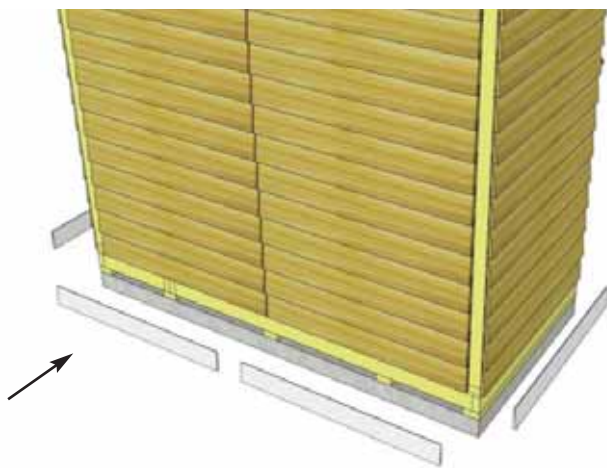
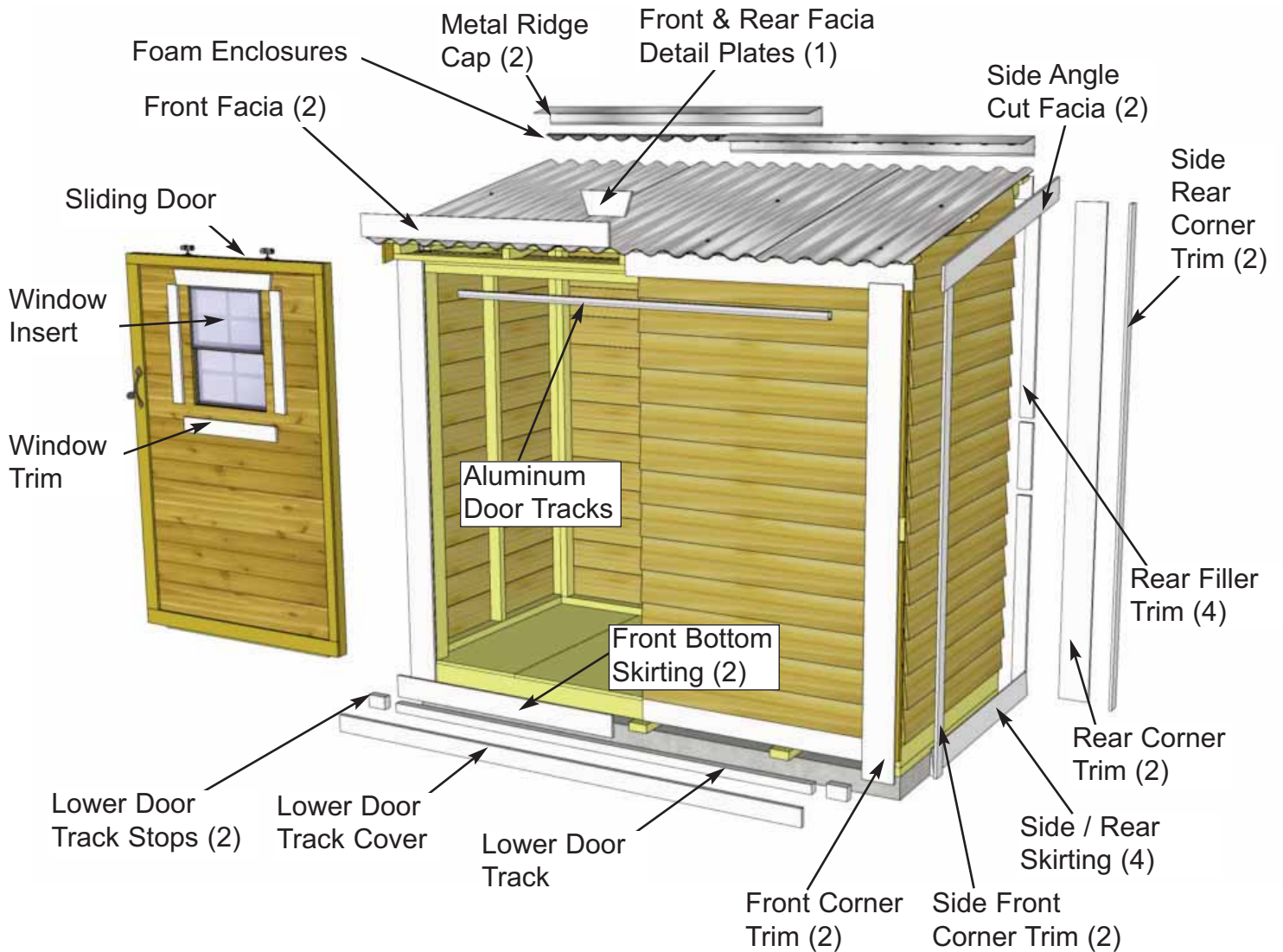

**49.** Attach **Bottom Skirting** (4 @ 3/4" x 4 1/2" x 45 1/4" - bevel) around the base of the shed. Skirting will hide floor framing. Start with side skirting pieces first and attach with **4 - 1 1/2" Finishing Nails** per piece.

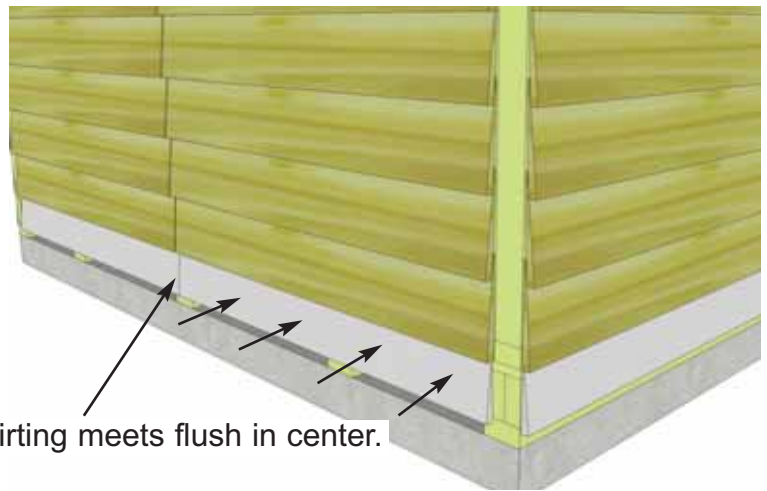

Skirting meets flush in center.

**50.** Rear skirting pieces will meet together in the center. Secure with **4 - 1 1/2" Finishing Nails** per piece.

Skirting meets flush in center.

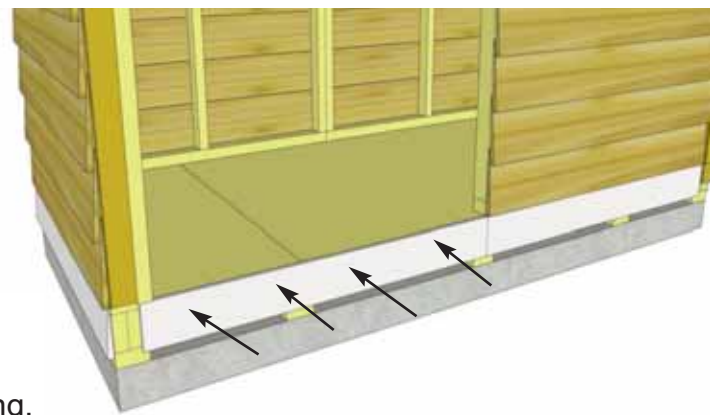

**51.** Attach **Front Skirting** (2 @ 1/2" x 4" x 45 1/4") with **4 - 1 1/4" Screws** per piece. Front Skirting does not have a bevel cut. Align as per side and rear skirting.

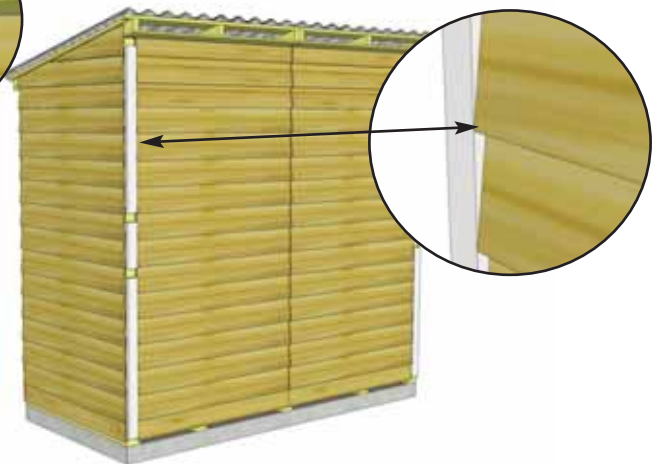
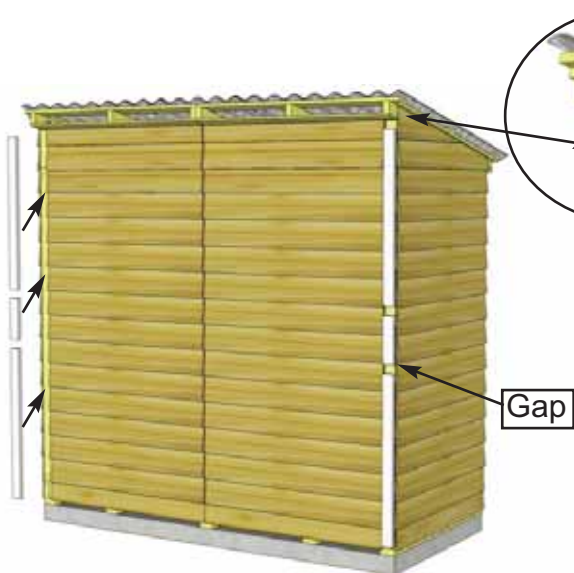

**52.** Locate **Rear Corner Filler Trims** (4 @ 7/8" x 2 1/2" x 36" & 2 @ 7/8" x 2 1/2" x 10"). Fillers are essentially nailing strips and will not be visible once additional corner trims are attached later. There will be two 36" long fillers and one 10" piece per corner. Position with a slight gap in the middle and attach with **4 - 1 1/2" Finishing Nails** per 36" piece and **2 - 1 1/2" Finishing Nails** per 10" piece.



**53.** To Trim out rear corners, locate a **Side Rear Corner Trim** (1/2" x 2 1/2" x 88 3/4") and a **Rear Corner Trim** (1/2" x 5 1/2" x 88 3/4").

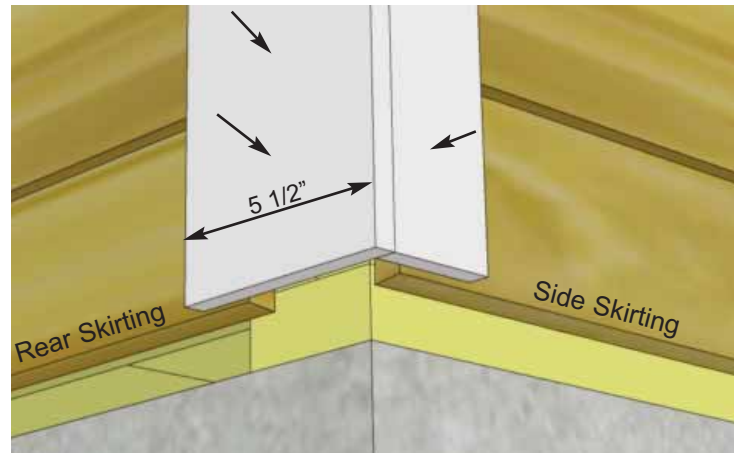
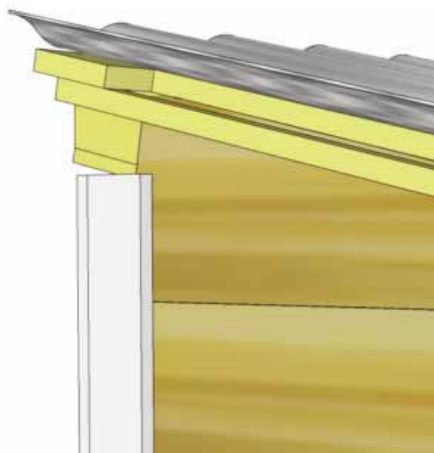

**54.** Place both trims in rear corner and align as illustrated above. Do a dry run prior to attaching to achieve best fit. Start with 5 1/2" wide Rear Corner Trim and align tight underneath soffit to determine vertical height. Attach with **8 - 1 1/2" Finishing Nails** per piece. Position and attach Side Rear Corner Trim (2 1/2" wide) using **8 - 1 1/2" Finishing Nails**, aligning at bottom with wide trim. Complete other front corner the same.



**See Step 61** to confirm Lower Door Track and Track Stops fit between Wide Front Corner Trim

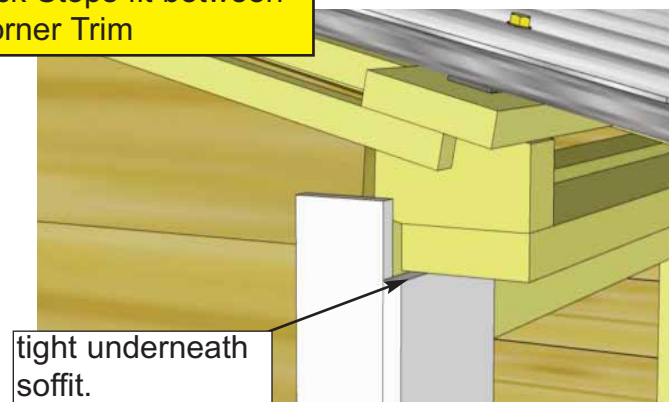

**55.** To completely trim out front corners, locate **Side Front Corner Trims** (1/2" x 2 1/2" x 80") and **Front Corner Trims** (1/2" x 5 1/2" x 79"). Align and attach as per **Step 53**.

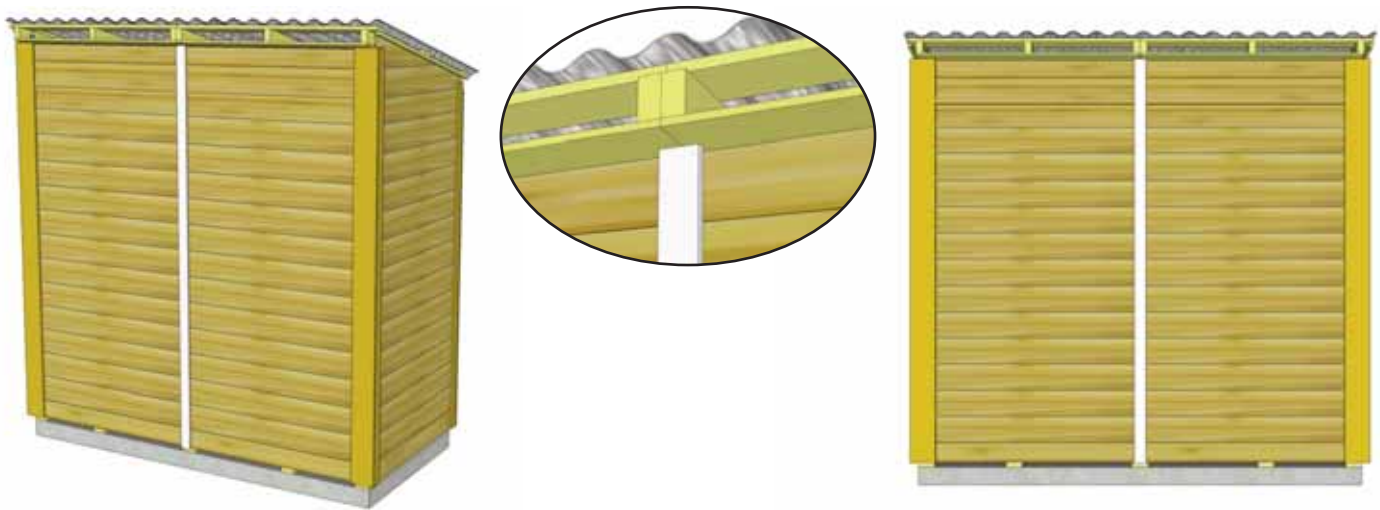

**56.** Attach **Rear Middle Trim** (1/2" x 2 1/2" x 88 3/4") where wall panels come together at rear seam. Attach with **8 - 1 1/2" Finishing Nails** aligning tight underneath soffit and center on seam.

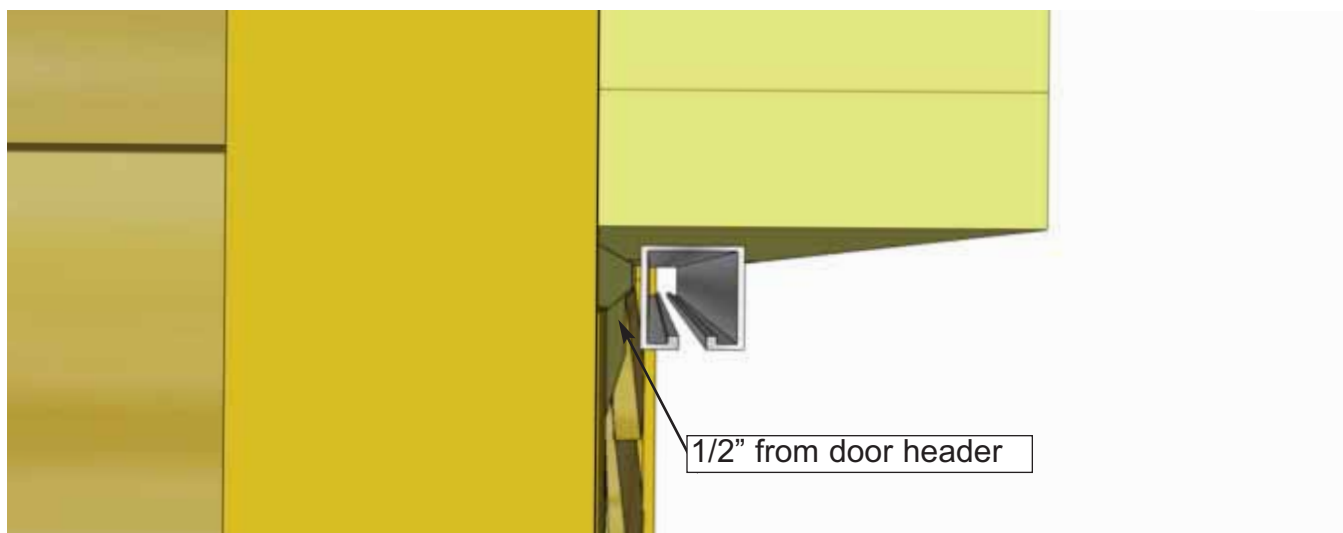

**57.** Position **Aluminum Door Track** on bottom of Front Soffits, spaced approximately 1/2" from edge of door header on either side. Attach with **8 - 1 1/4" screws**.

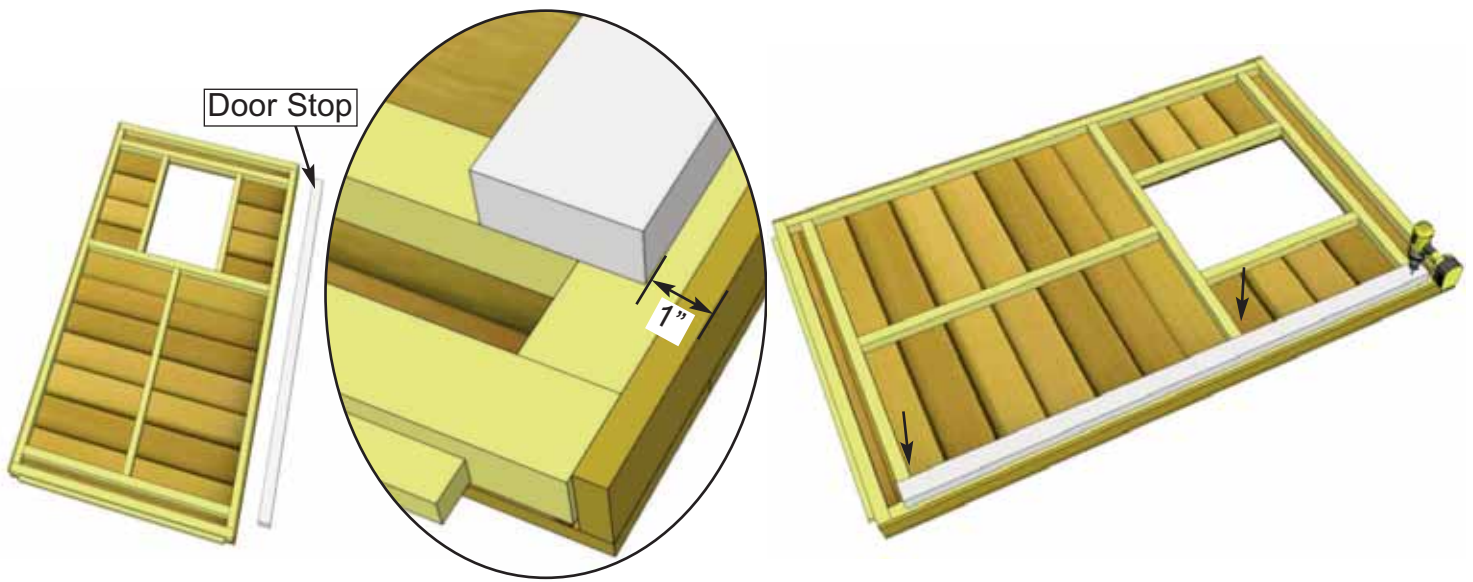

**58.** Locate Sliding Door and flip over onto a clean, dry and level spot. Position **Door Stop** (1 1/2" x 2 1/2" x 66 1/4") on left inside frame of door as shown above. Position 1" from outside trim of door as shown above. Attach with **3 - 2 1/2" Screws** into horizontal door framing.

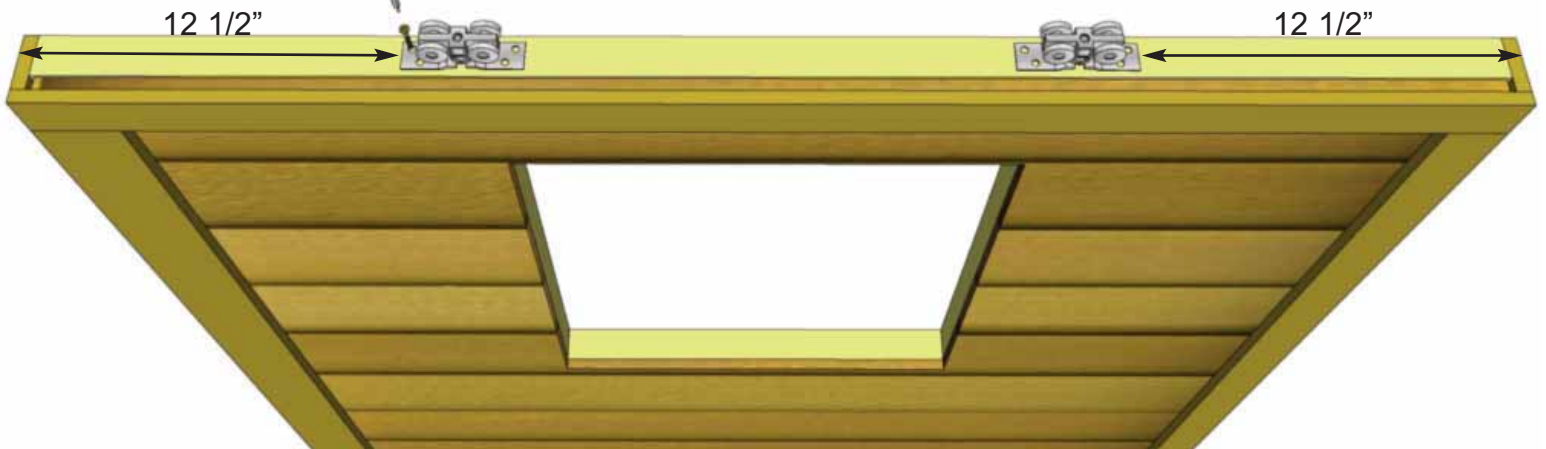
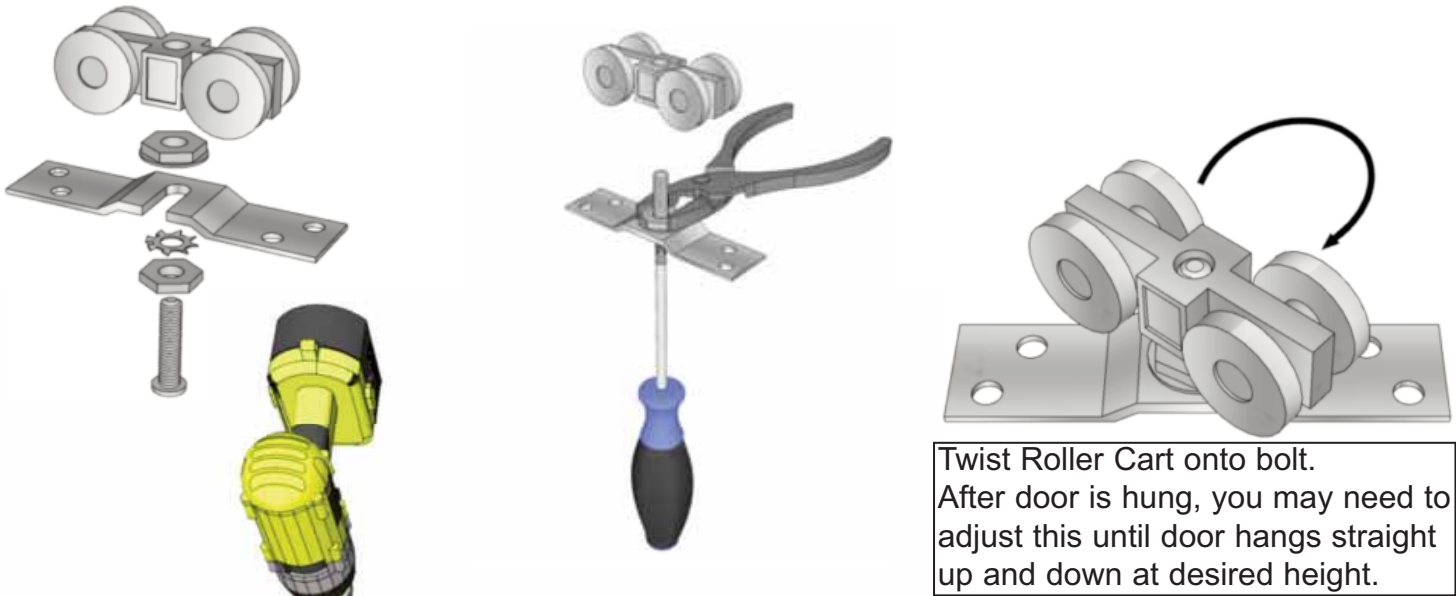

**59.** Locate **Roller Assemblies**. Before attaching to top of doors, assemble the units as shown above. Attach two Roller Assemblies onto door with **4 - 1 1/4" Screws** per Assembly, center on the door framing 12 1/2" from each end as shown above.

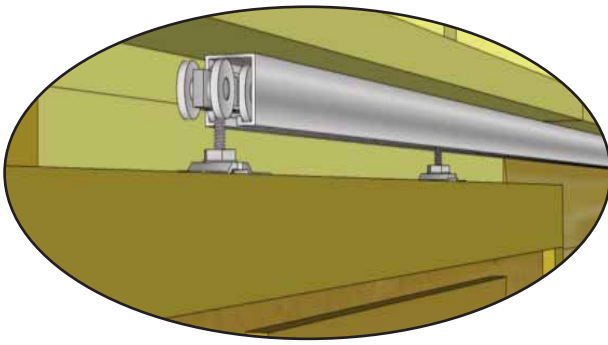

**60.** Pick up Sliding Door and carefully slide Rollers into the Aluminum Door Track.

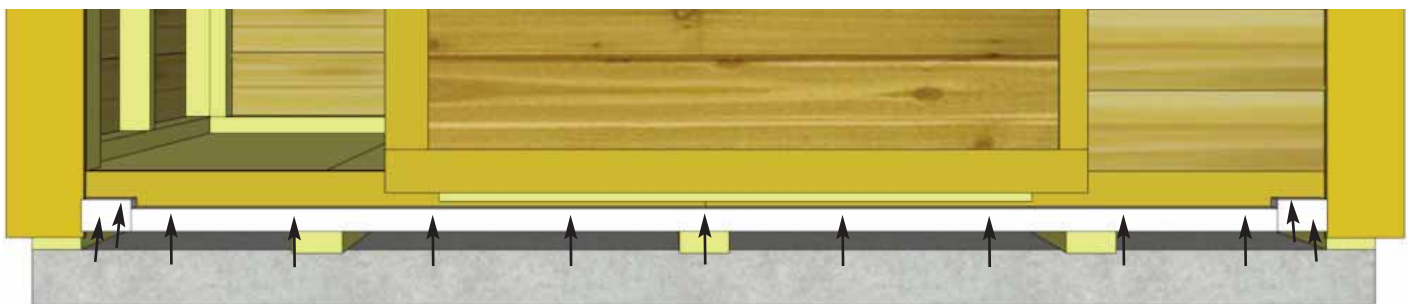
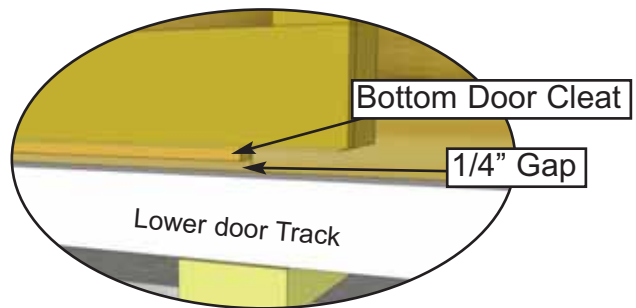
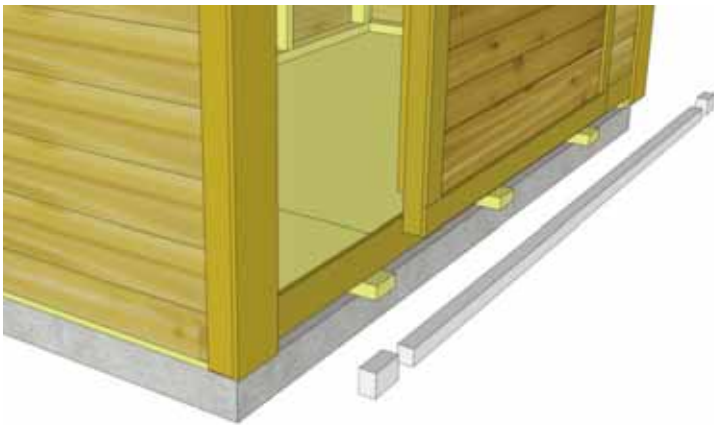

**61.** Locate **Lower Door Tracks** and **Door Stops**. Center Door Track side-to-side and resting on Long Floor Runners. Bottom of Door Stops and Door Tracks should be flush with each other. Secure Door Track to shed with **9 - 3" screws**. Secure Door Stops with **2 - 3" screws** per piece.

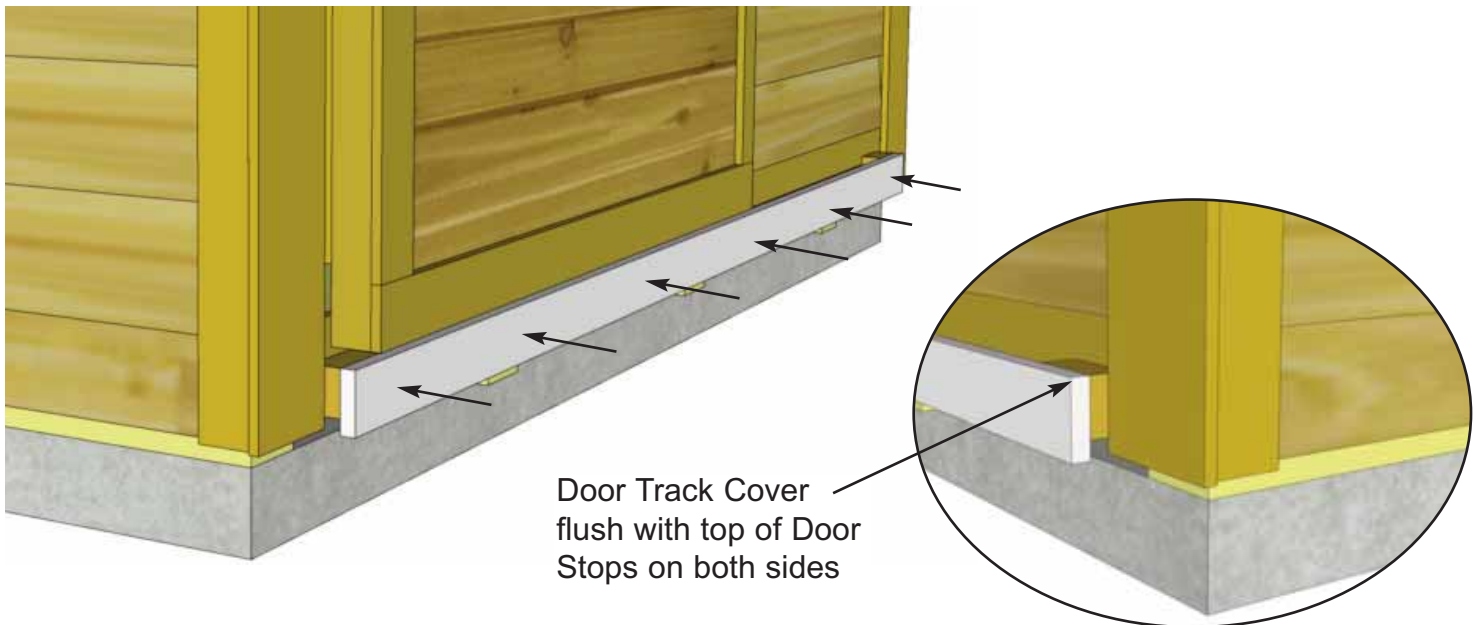
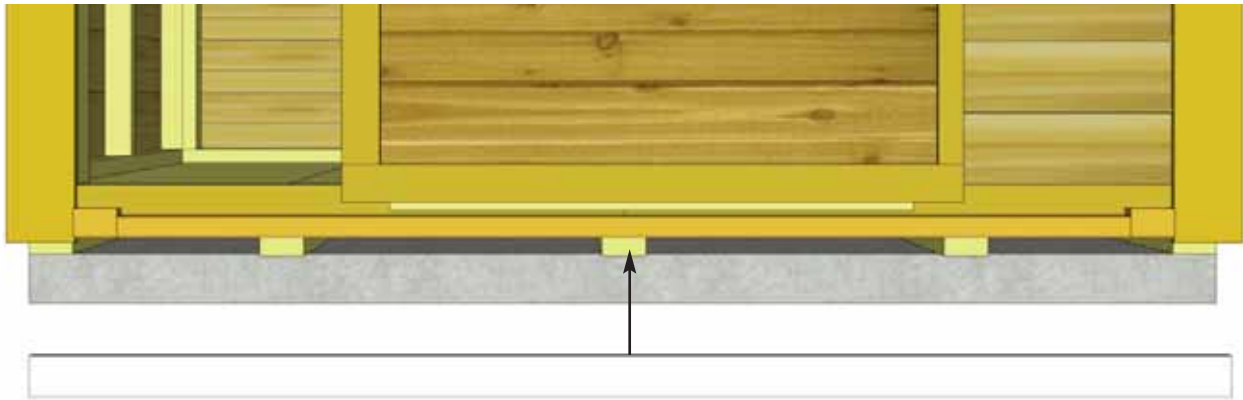

Door Track Cover  
flush with top of Door  
Stops on both sides

**62.** Locate **Door Track Cover**. Line up so Track Cover is flush with outside edges of Door Stops. This creates an enclosure so the door can not slide out of the track. Track Cover with **6 - 2 1/2" screws**.



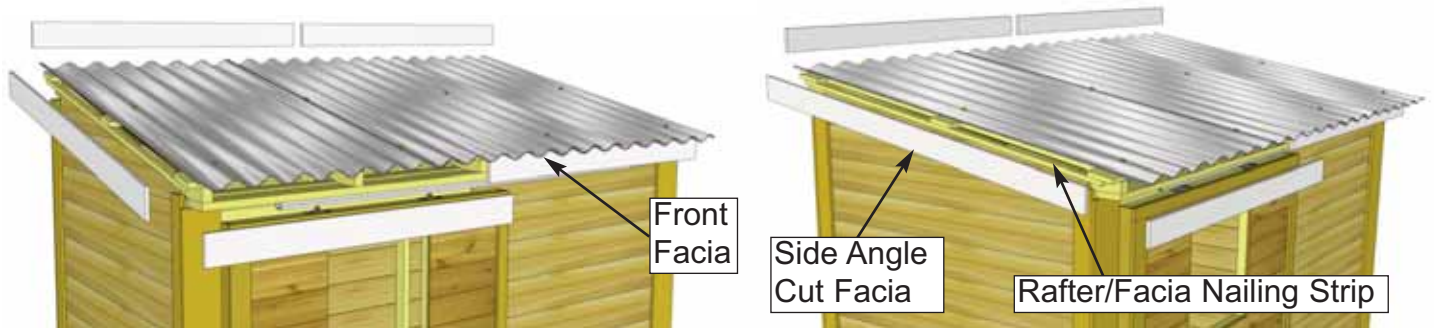

**63.** Locate and identify all Facia pieces: **Front & Rear Facia** (4 @ 1/2" x 4" x 50 1/2").  
**Side Angle Cut Facia** (2 @ 1/2" x 4" x 54 1/8"). In front corner, align side and front Facia together. Front facia will cap side facia.

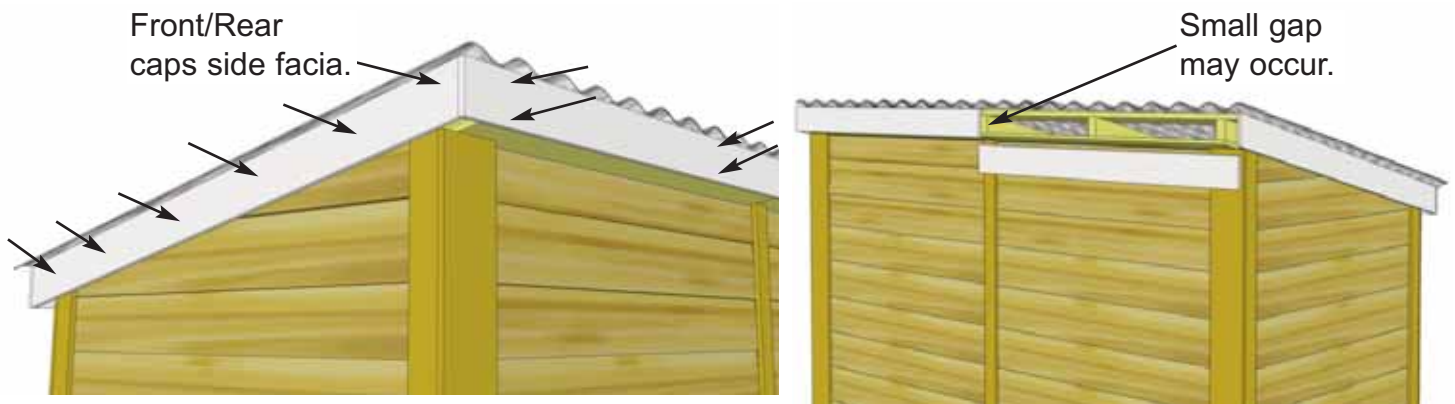

**64.** Do a dry run first before securing. Position Front Facia up underneath roof panel and against rafter ends. Have your helper hold in position. Place angle cut Side Facia underneath roof panel against Rafter/Facia Nailing Strip. Align so Front Facia caps Side Facia and then attach the front with **6 - 1 1/2" Finishing Nails**. Attach side with **5 - 1 1/2" Finishing Nails** securing them into the nailing strip (closer to the top of the side facia board). Attach next piece of Front Facia. **Note:** With Front Facia correctly aligned at corners, a small gap may occur at center seam. This will be covered by Facia Detail Plate in **Step 68**.



**65.** Place and align front and side facia for best possible fit with front capping side facia. Attach facia to rafter ends with **6 - 1 1/2" Finishing Nails** per piece. Complete both front facia pieces.



**66.** Place 3 pieces of **Foam Enclosures** on rear of Metal Roof Panels. Enclosures may need to be snipped down in length to fit. Space evenly from side-to-side before attaching Metal Ridge Cap in **Step 67**.



**67.** Place **Metal Ridge Caps** on top of Metal Roof at the rear of your shed. Evenly space from side-to-side, allowing the ridge caps to overlap each other. Overhang each cap approximately 1" on each end. When ridge caps are correctly positioned, secure with **4 - 2" Metal Screws**, using 1/4" Nut Driver as per **Step 48**. Screw into top most Batten. Metal screws are self-tapping, do not overtighten!

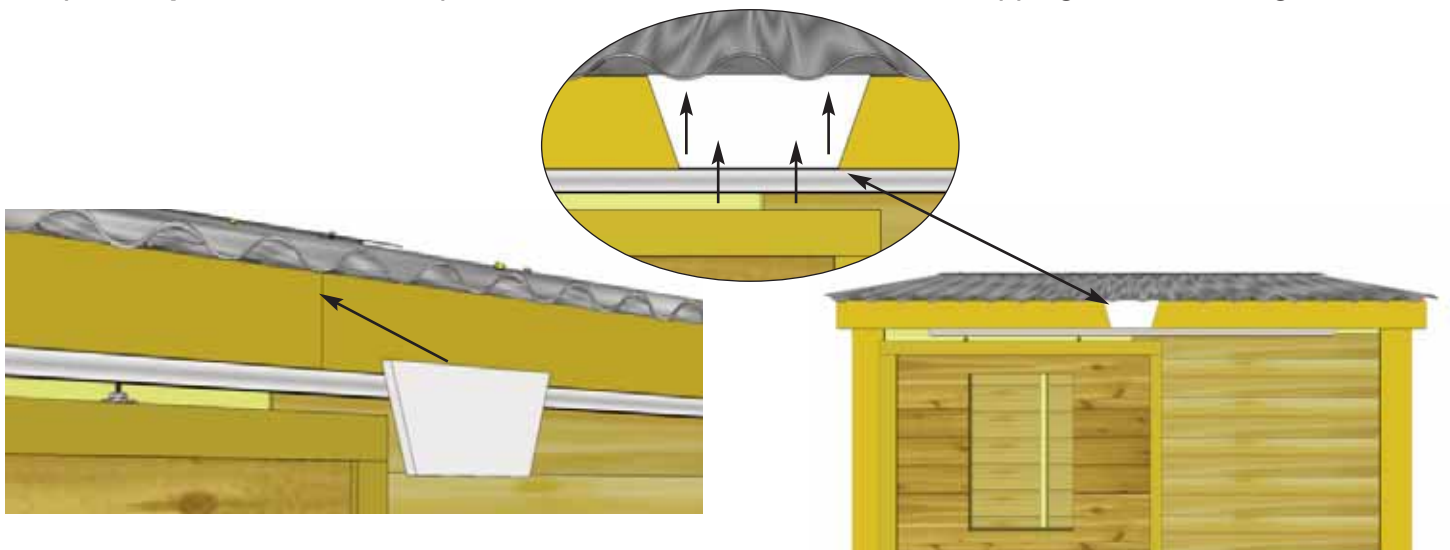

**68.** Attach **Facia / Detail Plates** to cover seams where Front and Rear Facia pieces come together. Secure with **4 - 1 1/2" Finishing Nails** per piece.

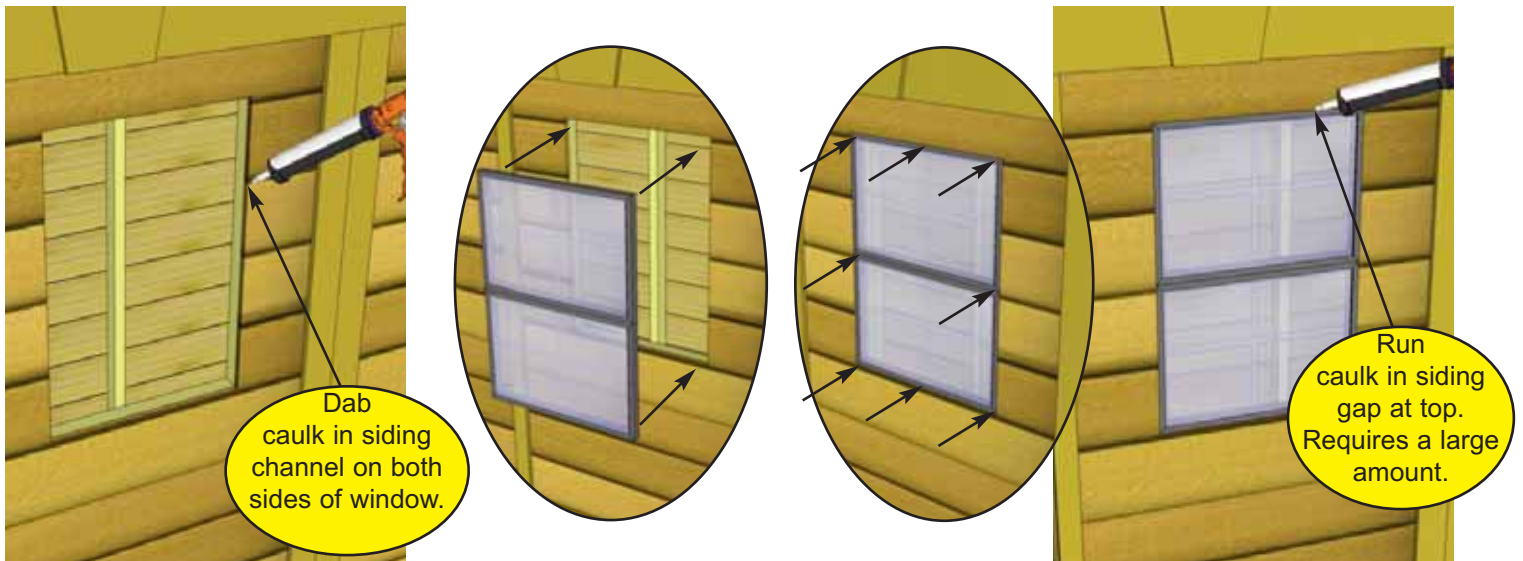

**69.** Locate **Window Insert**. Before installing, dab caulk in siding channel on both sides of window opening. This will prevent water from getting in behind window. Position window in cavity and secure with **8 - 1 1/4" Screws**. Caulk gap between siding and window at top. This requires a large amount of caulking but is important to fill. Later, Window Trims will be installed to hide caulking.

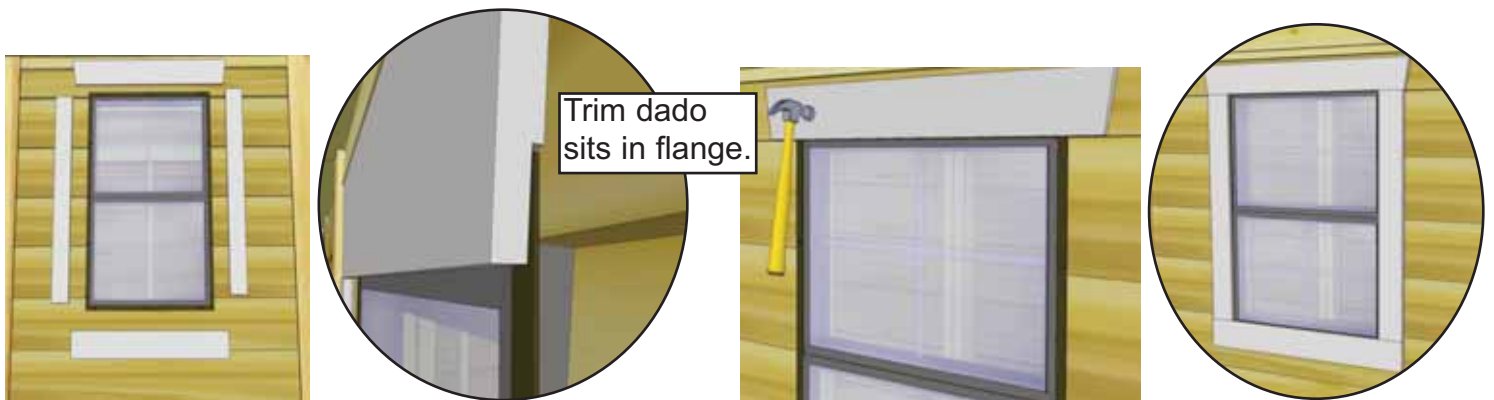

**70.** Position **Window Trim** around window doing a dry run first and attach with **4 - 1 1/2" Finishing Nails** per piece. Window trim has a small dado on reverse face. Outside flange of window will roughly sit in the dado to give a better fit.



**71.** Attach **Door Handles** and **Black Hasp** as shown above. Handles and Hasp mounted with **3/4" Black Screws**.



## Congratulations on completing your 8x4 SpaceSaver Shed!

**Note:** Our Sheds are shipped as unfinished products. If exposed to the elements, the Western Red Cedar lumber will weather to a silvery-gray color.

If you prefer to keep the cedar lumber looking closer to the original color, we suggest that you treat the wood with a good wood stain. You may also wish to paint your new shed rather than stain it. In both cases we recommend that you consult with a paint and stain dealer in your area for their recommendations.



We value your feedback and would like to hear back from you on how well we are doing in the following areas:

1. **Customer Service**
2. **On Time Shipping**
3. **Motor Freight Delivery**
4. **Quality of Materials**
5. **Assembly Manual**
6. **Overall Satisfaction.**

Please call, write or email us at:

Outdoor Living Today

Canadian Address  
9393 287th Street  
Maple Ridge, British Columbia  
Canada V2W 1L1

United States Address  
P.O. Box 96  
Sumas, Washington  
USA 98295



The materials contained in this Assembly Manual may be downloaded or copied provided that ALL copies retain the copyright and any other proprietary notices contained on the materials. No material may be modified, edited or taken out of context such that its use creates a false or misleading statement or impression as to the positions, statements or actions.