



12x4 SpaceSaver

Sliding Doors - Cedar Roof - FJ Siding

Assembly Manual

Stock Code:
SS124-SLIDER-CEDAR-FJ

Version #1.6
Apr 4, 2022

Thank you for purchasing a 12x4 SpaceSaver Shed with Sliding Doors. Please take the time to identify all the parts prior to assembly.

Safety Points and Other Considerations

Our products are built for use based on proper installation on level ground and normal residential use. Please follow the instruction manual when building your shed and retain the manual for future maintenance purposes.

Customers are responsible for ensuring a solid, level, well-draining site for construction.

Please check with your local municipal or county by-laws before ordering this product to confirm it complies with building codes.



- Snow load ratings vary by geographical location. If heavy or wet snowfall occurs, it is advisable to sweep snow off roof frequently.
- If the product is elevated, any structural and building code requirements are solely the customer's responsibility, and should be abided by.
- In areas with high or gusty wind conditions, it is advisable to install the structure securely to the ground.
- Have a regular maintenance plan to ensure screws, doors, windows and parts are tightly affixed.

Customer agrees to hold Outdoor Living Today and any Authorized Dealers free of any liability for improper installation, maintenance and repair.

In the event of a missing or broken piece, call the Outdoor Living Today Customer Support Line @ 1-888-658-1658 within 30 days of the delivery of your purchase. It is our commitment to you to courier replacement parts, free of charge, within 10 business days of this notification. Replacement parts will not be provided free of charge after the 30 day grace period.

All structures purchased from Outdoor Living Today are covered for a period of one year for defects in manufacturing and workmanship. Costs incurred for customer installations are not included.

Failure to use supplied parts included in this kit could result in poor product performance and may void your warranty. Please contact Outdoor Living Today's Customer Toll Free Line if you plan to deviate from our written instructions.

What to do before my Shed arrives?



- Become familiar with this assembly manual and determine if you can complete the project yourself or will require a professional contractor.



- One helper is recommended to assist in constructing your shed. It generally takes two people over two days to assemble a shed. If you're hiring a contractor, their rate should be in line with that duration of work.



- Clear the construction area and ensure a clear pathway for delivery when the freight company arrives. Remove all debris: roots, grass, rocks, etc.



- Excavate the site. Contact your local utilities company to ensure there are no gas or electric lines buried in the area before digging.

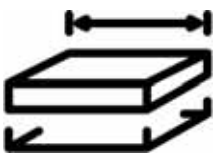

- Decide on the type of foundation you will be using:
 - Concrete slab, or
 - 4-6 inches of crushed gravel with paver stones or 4x4 stringers.

You can find the footprint for your shed on Page 3 of your Assembly Manual.



- If doing the assembly yourself, have all the necessary tools ready to go and in working condition. A list of required tools can be found after the parts list.

Foundation Types for 12x4 Garden Shed

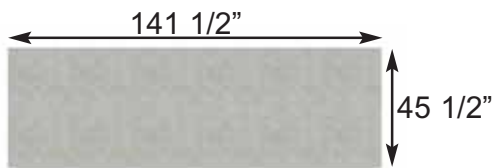

Concrete Foundation

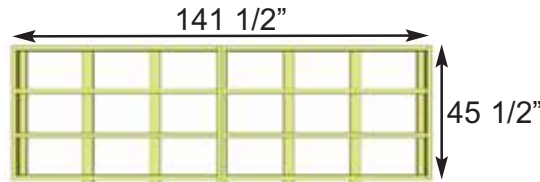

Floor Frame

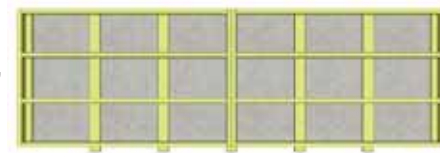

Completed Foundation

Concrete Slab Foundation:

- Slab must be at least the same size as assembled floor frame (45 1/2" x 141 1/2") or larger.
- 6" Deep foundation.
- 0.9 Cubic Yards of concrete required.
- A concrete slab will have the longest durability out of your foundation options.

Once level, a concrete slab is the easiest surface to build on.



Gravel Foundation

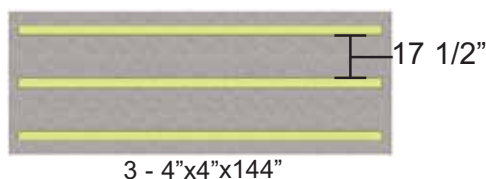

Gravel Foundation with treated stringers

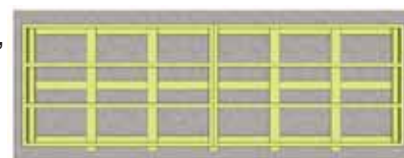

Completed Foundation

Gravel with 4x4 Pressure Treated Stringers:

- Excavate at least 6" deep, and 6" wider than floor frame on each side.
- 1.2 Cubic Yards of gravel required, approximately 11 wheelbarrows.
- 3 - 4x4 Pressure Treated Stringers 12' long required.
- Evenly spaced, with one at each end of floor frame.

Saves money on materials, easy to level and work with.



Gravel Foundation

21 Patio Stones



Gravel Foundation with Patio Pavers

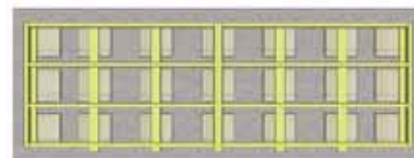

Completed Foundation

Gravel with Patio Paver Stones:

- Excavate at least 6" deep, and 6" wider than floor frame on each side.
- 1.2 Cubic Yards of gravel required, approximately 11 wheelbarrows.
- 21 patio pavers (8" x 8" or larger).
- Center patio paver stones underneath floor runners and underneath seams in floor joists.

Patio paver stones are widely available from most landscape stores.

Thank you for purchasing our 12x4 SpaceSaver Sliding Door Shed.
Please take the time to identify all the parts prior to assembly.











1. Floor Section	Parts List - Pages 4 and 5	Steps↓
Floors -----		1-6
1A: 2 - 45 ½" x 70 ¾" - Floor Frames		
1B: 4 - 1 ½" x 3 ½" x 67 ¾" - Floor Joists		
1C: 2 - 1 ½" x 3 ½" x 45 ½" - Floor Runners - Short		
1CC: 5 - 1 ½" x 3 ½" x 47 ½" - Floor Runners - Long		
1D: 2 - 5/8" x 45 3/8" x 70 5/8" - Plywood Floor		
2. Wall Section		Steps↓
Main Wall Panels -----		7-13
2A: 5 - 45 ½" x 75" - Side/Rear Wall Panels		
2B: 5 - 1 5/8" x 2 ½" x 45 ½" - Bottom Wall Plates - Side/Rear Walls		
2BB: 2 - 1 5/8" x 2 ½" x 35" - Bottom Wall Plates - Front Walls		
2C: 2 - 35" x 73" - Front Wall Panels		
Door Headers -----		14-15, 23
2D: 2 - 2" x 3 ½" x 26 ¼" - Door Headers - Short		
2E: 1 - 2" x 3 ½" x 84" - Door Header - Long (88" Aluminum Strip Attached)		
2EE: 1 - 1 ½" x 3" x 66 ½" - Interior Door Header		
Extender Walls -----		16-21
2F: 2 - Top Triangular Siding Pc for Angle Wall Extenders		
2G: 2 - 45 ¼" - Angle Wall Extenders - Left/Right		
2H: 3 - 9" x 45 ½" - Wall Extenders		
Wall Cleats -----		22
2I: 1 - ¾" x 3 ½" x 84" - Horizontal Wall Cleat - Long		
2J: 2 - ¾" x 3 ½" x 26 ¼" - Horizontal Wall Cleats - Short		
3. Rafter and Roof Section		Steps↓
Rafters -----		24-29
3A: 9 - 1 ½" x 2 ½" x 54" - Rafters		
3B: 2 - 1" x 3 ½" x 48" - Front Soffits - Left/Right		
3C: 1 - 1" x 3 ½" x 45 ½" - Front Soffit - Center		
3D: 2 - ½" x 3 ½" x 48" - Rear Soffits - Left/Right		
3E: 1 - ½" x 3 ½" x 45 ½" - Rear Soffit - Center		
Roofs -----		30-39
3F: 2 - ¾" x ¾" x 51" - Facia Nailing Strips		
3G: 2 - Roof Panels - 51" w x 56" d (1 - Left 1- Right)		
3H: 1 - Roof Panel - 45 ½" w x 56" d (Center)		
3I: 8 - 5 ½" Wide x 16" to 18" long - Filler Shingles		
4. Trim & Miscellaneous Section		Steps↓
Bottom Skirting -----		42-44
4A: 5 - ½" x 4 ½" x 45 ¼" - Side/Rear Bottom Skirting (Bevel Siding)		
4B: 3 - ½" x 4" x 45 ¼" - Front Bottom Skirting		
Filler Trim -----		45-46
4C: 4 - ½" x 2 ½" x 38" - Front Corner Filler Trims		
4D: 4 - ¾" x 2 ½" x 42" - Rear Corner Filler Trims		
Door System -----		47-52
4E: 2 - Aluminum Door Tracks		
4F: 2 - 36" x 73" - Sliding Doors		
4G: 1 - ¾" x 3 ½" x 71 ½" - Interior Door Flange		
4H: 2 - 1 ½" x 1 5/8" x 61 1/8" - Lower Door Track		
4I: 3 - ¾" x 3 1/2" x 44 ¼" - Lower Door Track Cover		
4J: 3 - 1 ½" x 2 ¼" x 3 ½" - Sliding Door Track Stops		
Note: There are no Parts 4K or 4L		
Outer Wall Trim -----		53-55
4M: 2 - ½" x 5 ½" x 78 ½" - Front Corner Trims		
4N: 2 - ½" x 2 ½" x 80" - Side Front Corner Trims		
4O: 2 - ½" x 5 ½" x 88 ¾" - Rear Corner Trims		
4P: 4 - ½" x 2 ½" x 88 ¾" - Side Rear Corner & Middle Trims		

Continued on next page.

Note: All Trim, Facia, and Bottom Skirting pieces will be positioned rough face out when installed.

4. Trim & Miscellaneous Section Cont.		Steps ↓
Facia -----		56-60
4Q: 2 - ½" x 5 ½" x 54 1/8" - Side Facia (Angle Cut Ends)		
4R: 4 - ½" x 5 ½" x 50 ½" - Front and Rear Facia - Left/Right		
4S: 2 - ½" x 5 ½" x 45 ½" - Front and Rear Facia - Center		
4T: 4 - Facia Detail Plates (5 ½" high)		
Ridge Boards -----		61
4U: 3 - ½" x 4 ½" x 49 ¼" - Roof Ridge Boards		
Windows -----		62-63
4V: 2 - Window Inserts 18 1/4"w x 23"h		
4W: 2 - Window Trim Kits		
1 - Top pc - 24 1/16" Length - Angle Cut Ends		
3 - Side/Bottom pcs - 23" Length		
Miscellaneous		
4X: 1 - 45 ¼" - Extra Piece of Bevel Wall Siding		
- Use if side/rear wall panel siding is damaged or to shim floor or door.		
4Y: 1 - 36" - Extra Piece of Lap Siding		
- Use if front wall panel siding is damaged		

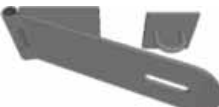
12X4 SpaceSaver Sliding Door Shed **HARDWARE PACKAGE**

BR1 - Square Drive Bit		x 2		
N1 - 1 1/2" Finishing Nails		x 305		
S4 - 3" Screws		x 51		Y2 - 90° Metal Bracket (Roof) x 8
S1 - 2 1/2" Screws		x 234		
S2 - 1 1/4" Screws		x 190		
SB1 - 3/4" Screws		x 20 Black Headed		
		Y11 - Black Hasp x 1	Y3 - Black Handle x 2	

Tools Required (Not Provided)

				
Utility Knife	Pliers	Hammer	Screw Gun/Drill	Tape Measure
				
Level	Wood Clamp	Ladder	1/8" Drill Bit	

Safety Equipment Required

(Not Provided)



Safety Glasses



Work Gloves

Regular Maintenance & Tips to prolong the life of your shed.

Before/During Assembly:

- 1.) Paint each face and edge of your plywood floor with a latex exterior paint.
- 2.) Caulk wall seams if gaps appear.
- 3.) Caulk around window framing.
- 4.) Caulk perimeter between floor plywood and bottom wall plate.
- 5.) Caulk channels in lap siding at the top of your door above the trim, just a drop in each channel.
- 6.) Caulk edge of door threshold (if applicable).
- 7.) Optional: Install a Sill Gasket between floor runners and foundation.
- 8.) Optional: Install an 8" strip of roofing paper below Cedar Ridge Caps for Cedar Roof Sheds.

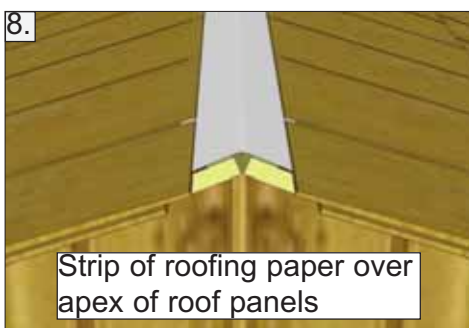
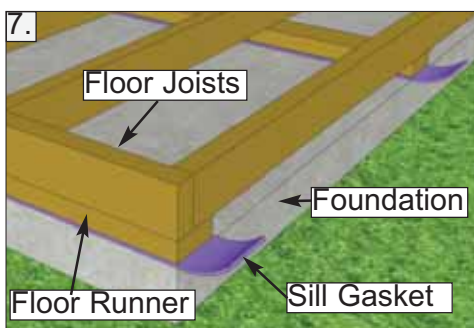
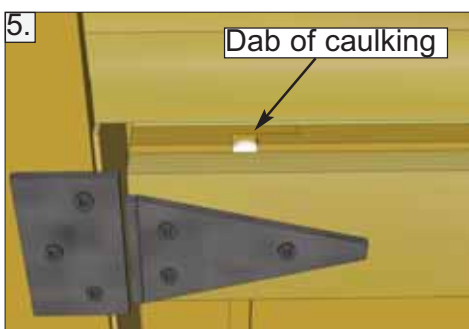
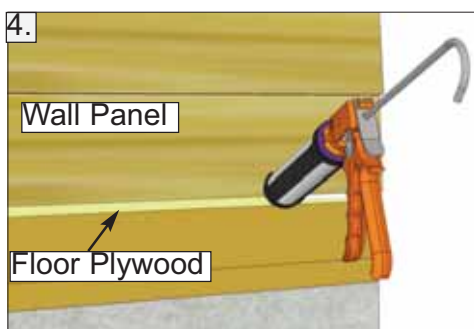
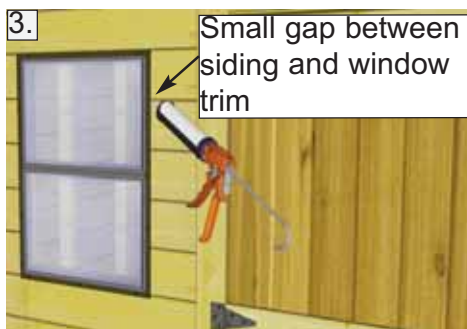
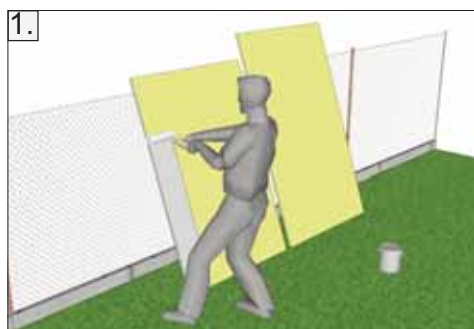

Routine Maintenance:

- Routinely check all fasteners are tight (ex. Door Hinges, Nails)
- Brush off dirt from walls.
- Brush off snow from roof regularly.
- Routinely remove needles and leaves from roof.

Painting/Staining

- Your cedar shed, if left untreated, will weather to a silvery grey colour.
- Painting or staining your structure is highly recommended and will prolong the life of your shed.
- You do not need to wait to paint or stain your shed, the wood in your kit has been dried and can be stained or painted immediately.
- Consult your local paint store for the best paint or stain for cedar.
- Optional: stain the inside of your shed. (Note: this will remove the fresh cedar smell.)

1. Floor Section

Exploded view of all parts necessary to complete Floor Section. Identify all parts prior to starting.
Note: Floor Footprint is 141 1/2" wide x 45 1/2" deep.

Floor Frames - 2pcs.
(Part 1A)

Plywood Floor - 2pcs.
(Part 1D)

Center Floor
Joists - 4pcs.
(Part 1B)

Floor Runners - 7pcs.
(Part 1C)

Concrete Pad
(optional foundation method)

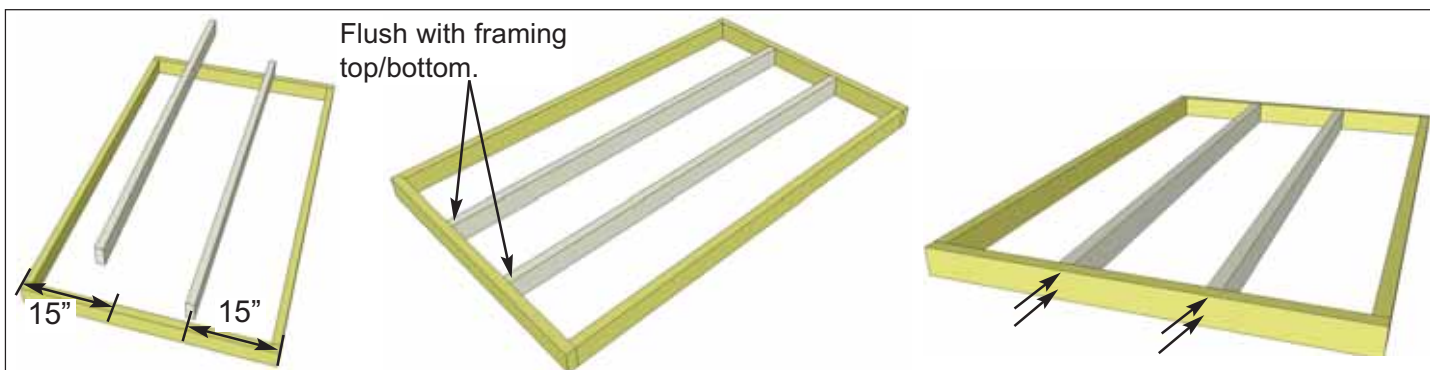

1. Lay out **1A - Floor Frame** and two **1B - Floor Joists** as illustrated above. Position the center of each Joist 15" from the outer edge of Floor Frame. When correctly positioned, attach each Joist with **4 - 2 1/2" Screws** (2 per end). **You can find the Square Drive Screw Bit in the Hardware Kit Bag.** Complete remaining Floor Frame the same.

<u>Parts</u>
1A - Floor Joist Frames (45 1/2" x 70 3/4") x 2
1B - Floor Joists (1 1/2" x 3 1/2" x 67 3/4") x 4
<u>Hardware</u>
S1 - 2 1/2" Screws x 16 total

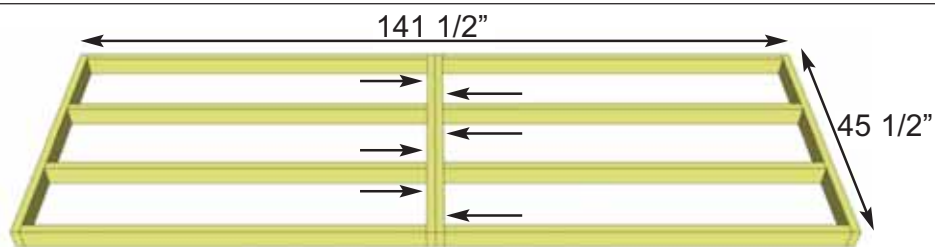

You can find BR1 - Square Drive Bit for the screws in with the Hardware Kit Bag.

2. Lay out both complete floor joist frames as illustrated. The footprint for the floor when attached together will be 141 1/2" wide x 45 1/2" deep. Attach frames together with **6 - 2 1/2" Screws**.

<u>Hardware</u>
S1 - 2 1/2" Screws x 6 total

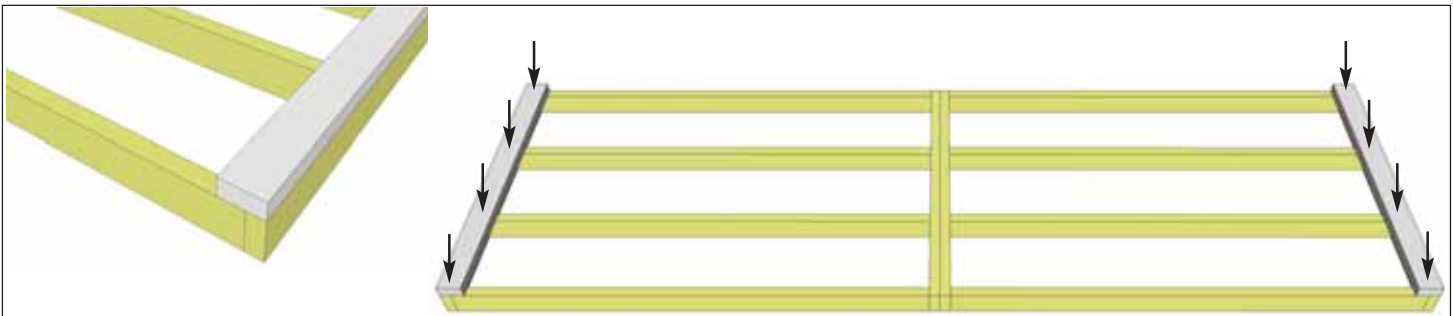

3. Position 1C - Floor Runners - Short on each side of the completed floor frame. Runners should be flush with corners but not overhanging. Attach with **4 - 2 1/2" Screws** per Runner.

Parts
1C - Floor Runners - Short
(1 1/2" x 3 1/2" x 45 1/2") x 2

Hardware
S1 - 2 1/2" Screws
x 8 total

Floor Runners flush with Floor Frame on back.

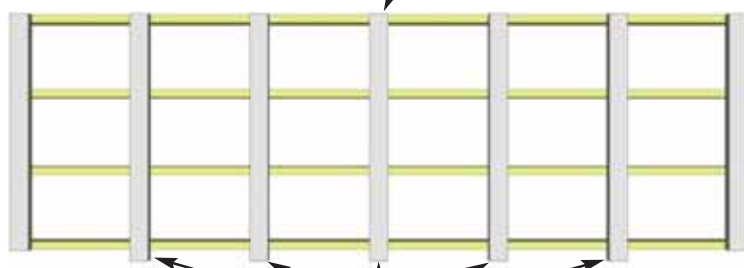

Long Floor Runners overhanging Floor Frame on front.

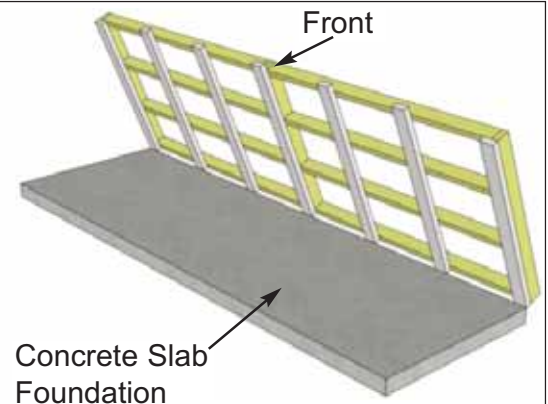

4. Align 1CC - Floor Runners - Long evenly spaced as shown above and flush with the back of the Floor Frame. On the front, Runners will extend 2" past the Floor Frame to provide support for the Sliding Door Track later in the Assembly. Attach with **4 - 2 1/2" Screws** per Runner.

With Floor Runners attached, carefully flip the floor over and place on your foundation. **Caution** - Be careful when laying floor down not to bend or twist floor. **Note:** Having a level foundation is critical. Choosing a foundation will vary between regions. Typical foundations can be concrete pads or patio stones positioned underneath the floor runners.

Parts
1CC - Floor Runners - Long
(1 1/2" x 3 1/2" x 47 1/2") x 5

Hardware
S1 - 2 1/2" Screws
x 20 total

Note: Plywood is cut slightly smaller than floor framing. Keep plywood seams tight.

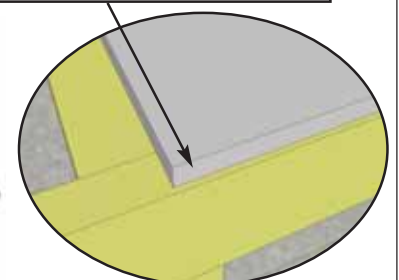
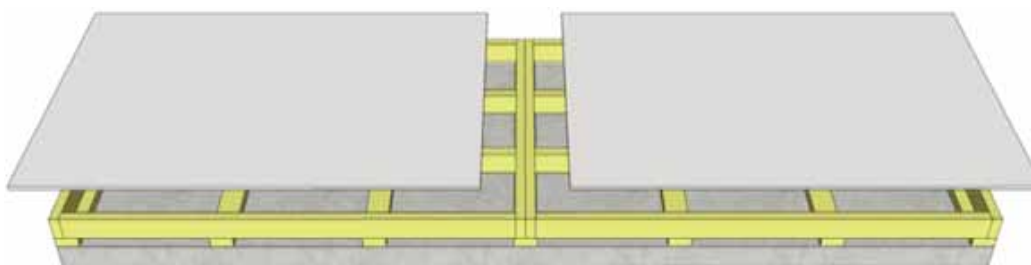

5. Position 1D - Plywood Floor on top of completed floor frames. Plywood will sit slightly inset from outside of floor frame.

Parts
1D - Plywood Floor
(5/8" x 45 3/8" x 70 5/8") x 2

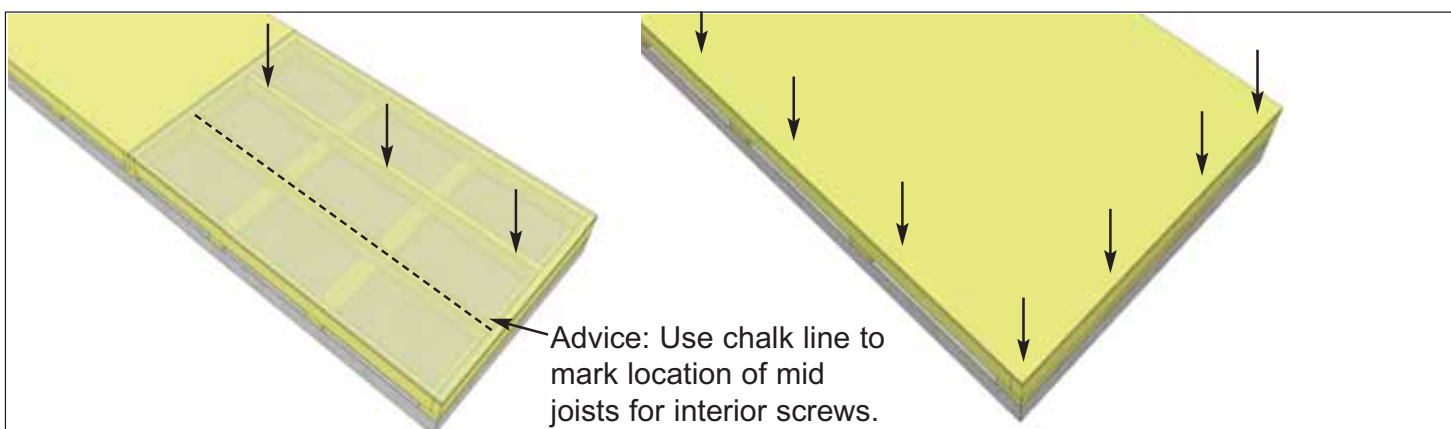

6. With Plywood positioned correctly on floor framing, attach with **1 1/4" Screws**. Use screws every 16" around perimeter of each floor section and 3 screws through each mid joists.

Hardware
S2 - 1 1/4" Screws
 x 40 total (approx.)

2. Wall Section

Exploded view of all parts necessary to complete the Wall Section. Identify all parts prior to starting.

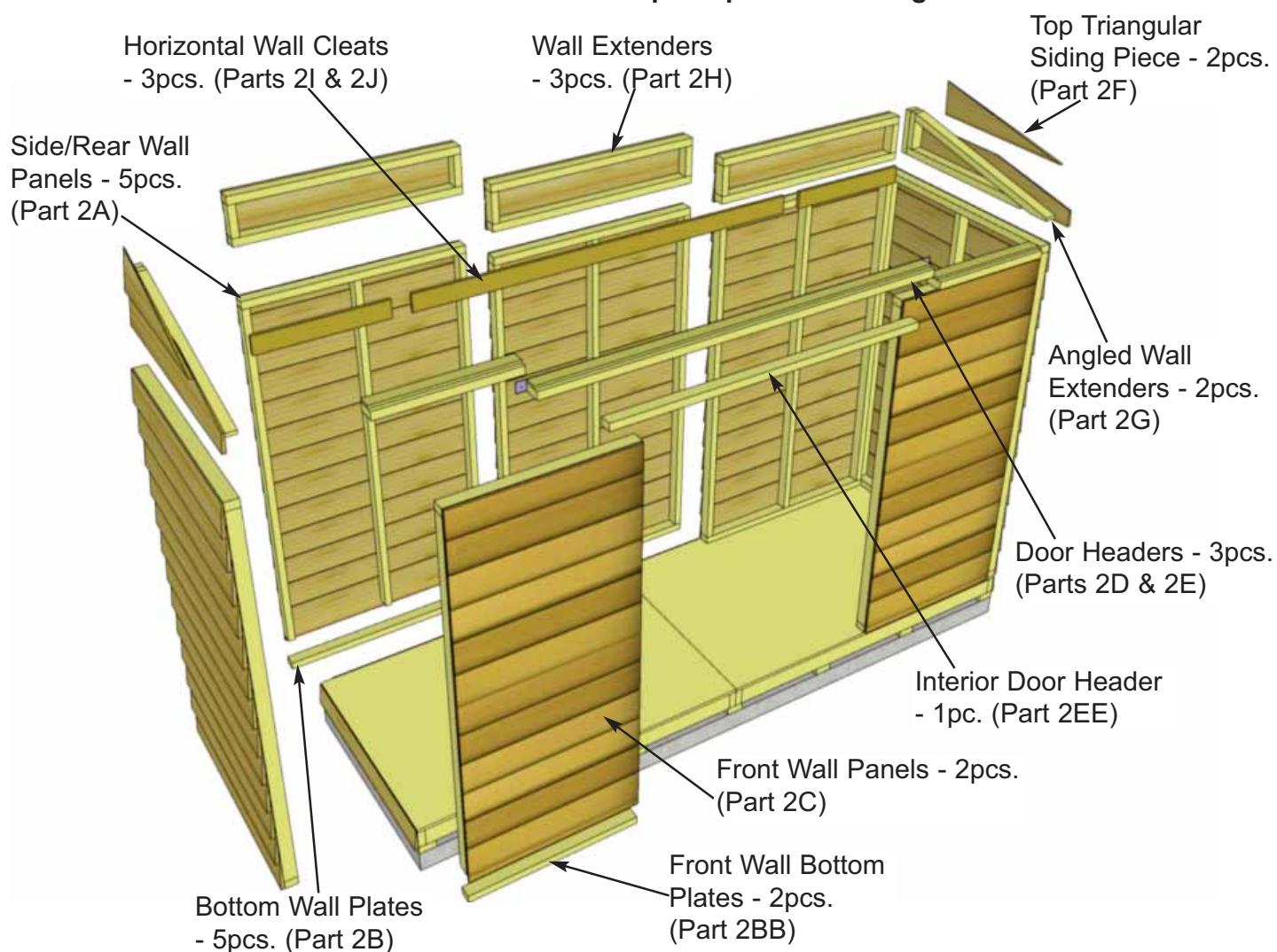

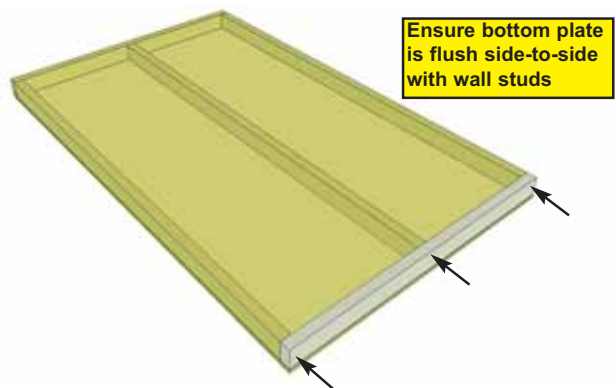
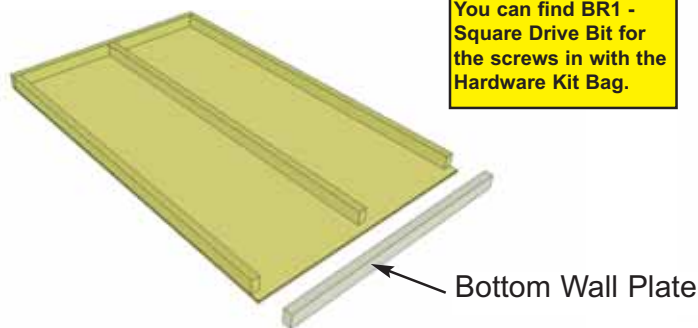

7. Carefully lay **2A - Side/Rear Wall Panels** face down. Position and attach **2B - Bottom Wall Plates** to bottom of wall studs of each wall panel with **3 - 2 1/2" Screws**. Position so plates are flush with framing. Complete 4 remaining solid walls.

Parts
2A - Side/Rear Wall Panels
 (45 1/2" wide x 75" high) x 5
2B - Bottom Wall Plates
 (1 5/8" x 2 1/2" x 45 1/2") x 5

Hardware
S1 - 2 1/2" Screws
 x 15 total

Important: Make sure all walls are aligned in their upright position. If not, water may leak into your shed. Unsure if panel is facing up or down? Recently attached Bottom Plate is on bottom of panel.

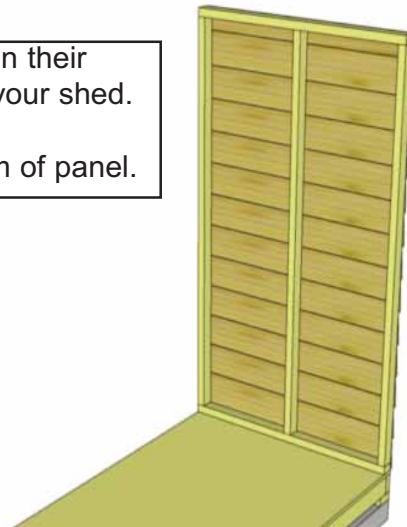

8. Starting on one side, position a Solid Wall Panel on top of plywood floor. The Wall Panel bottom framing will sit flush with the outside of the floor frame. Wall siding will overhang the floor.

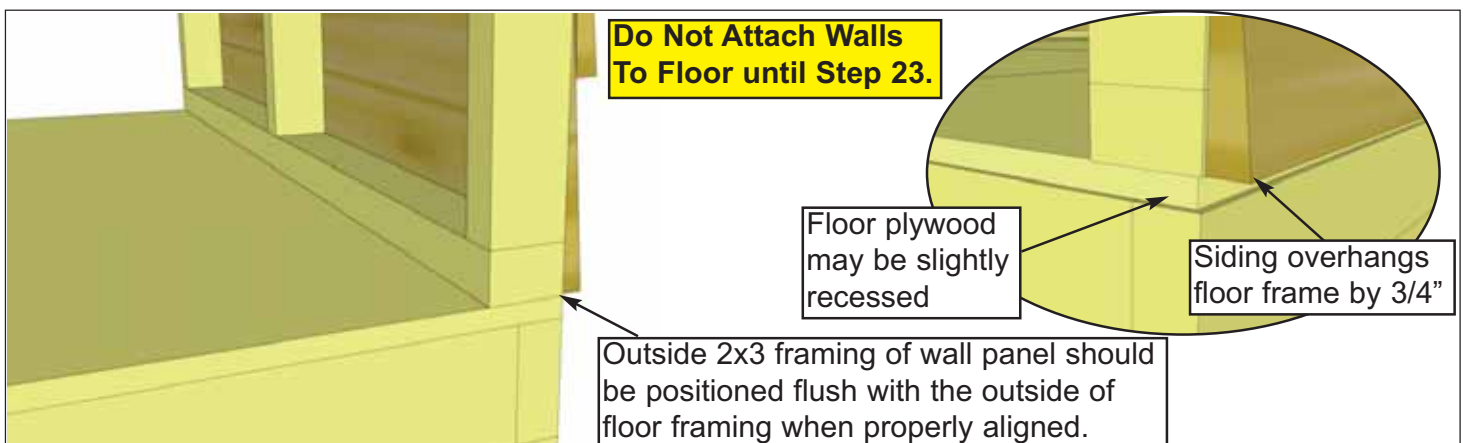

9. The side wall panels will sit even with the floor frame and the rear wall panels will be sandwiched between the side wall panels. The floor plywood may be slightly recessed.

Note: Siding will overhang the floor frame by approximately 3/4".

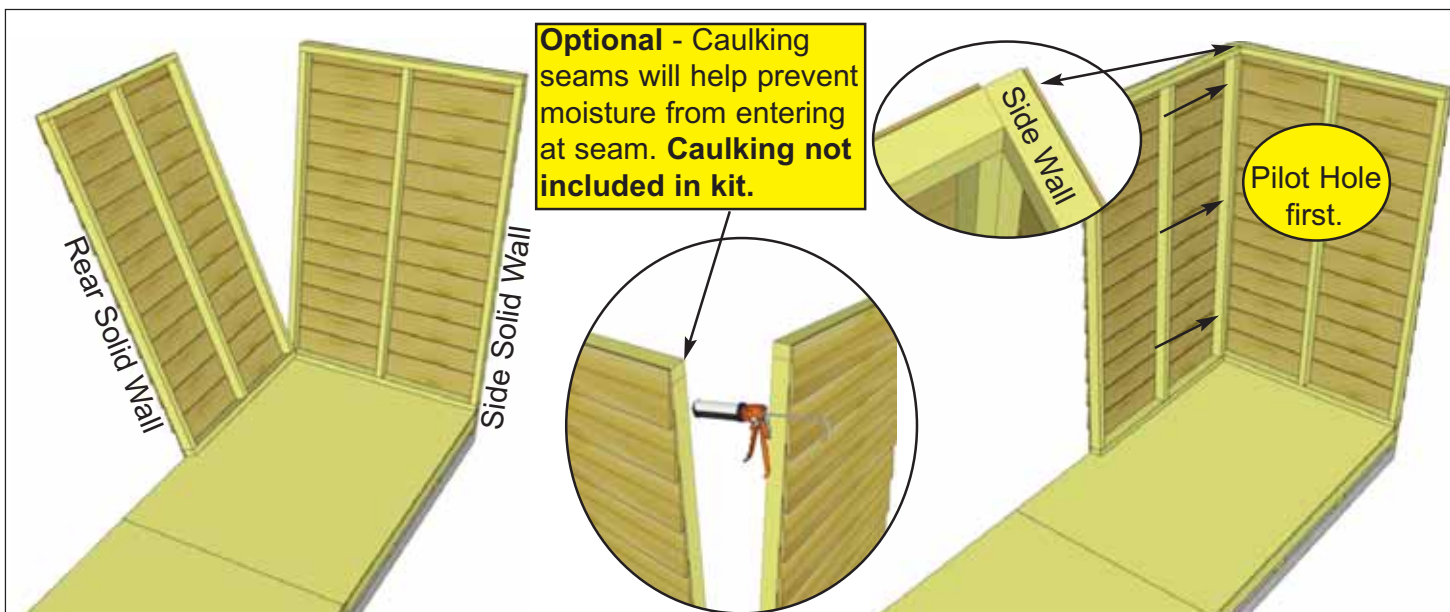

10. Position rear solid wall into place on plywood floor. Butt both vertical wall studs of side and rear walls together and attach with **3 - 2 1/2" Screws**. Screw at the bottom, middle and top of stud to secure properly.
Note: Drill pilot holes in studs to prevent splitting.

Hardware (Steps 10 - 12)
S1 - 2 1/2" Screws
 x 12 total

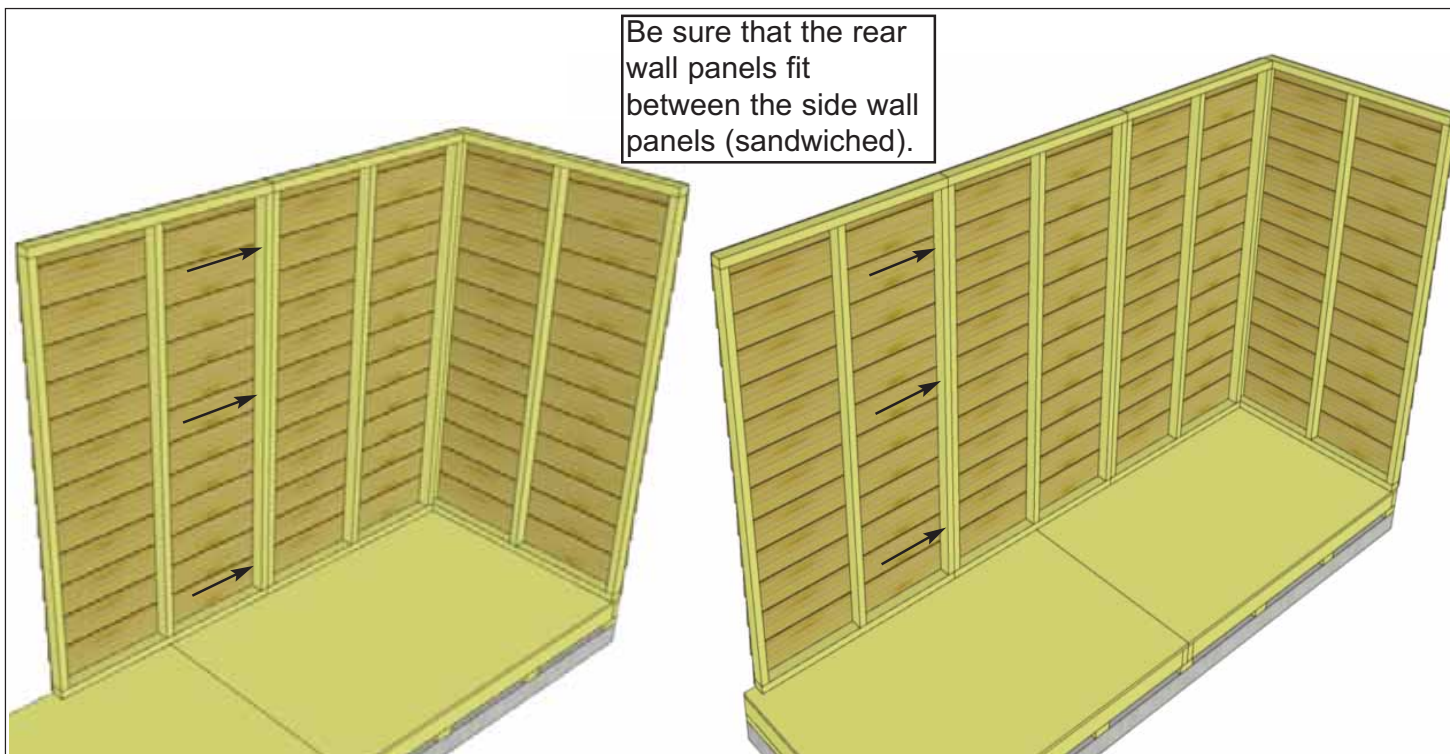

11. With the corner wall attachment complete, position a second rear wall panel in place so bottom 2x3 wall framing is sitting flush with outside floor joists. Wall siding should overhang floor by approximately 3/4". When positioned correctly, attach both side wall panel studs together as per **Step 10**.



12. Complete remaining side wall attachment as per **Steps 10 - 11.**

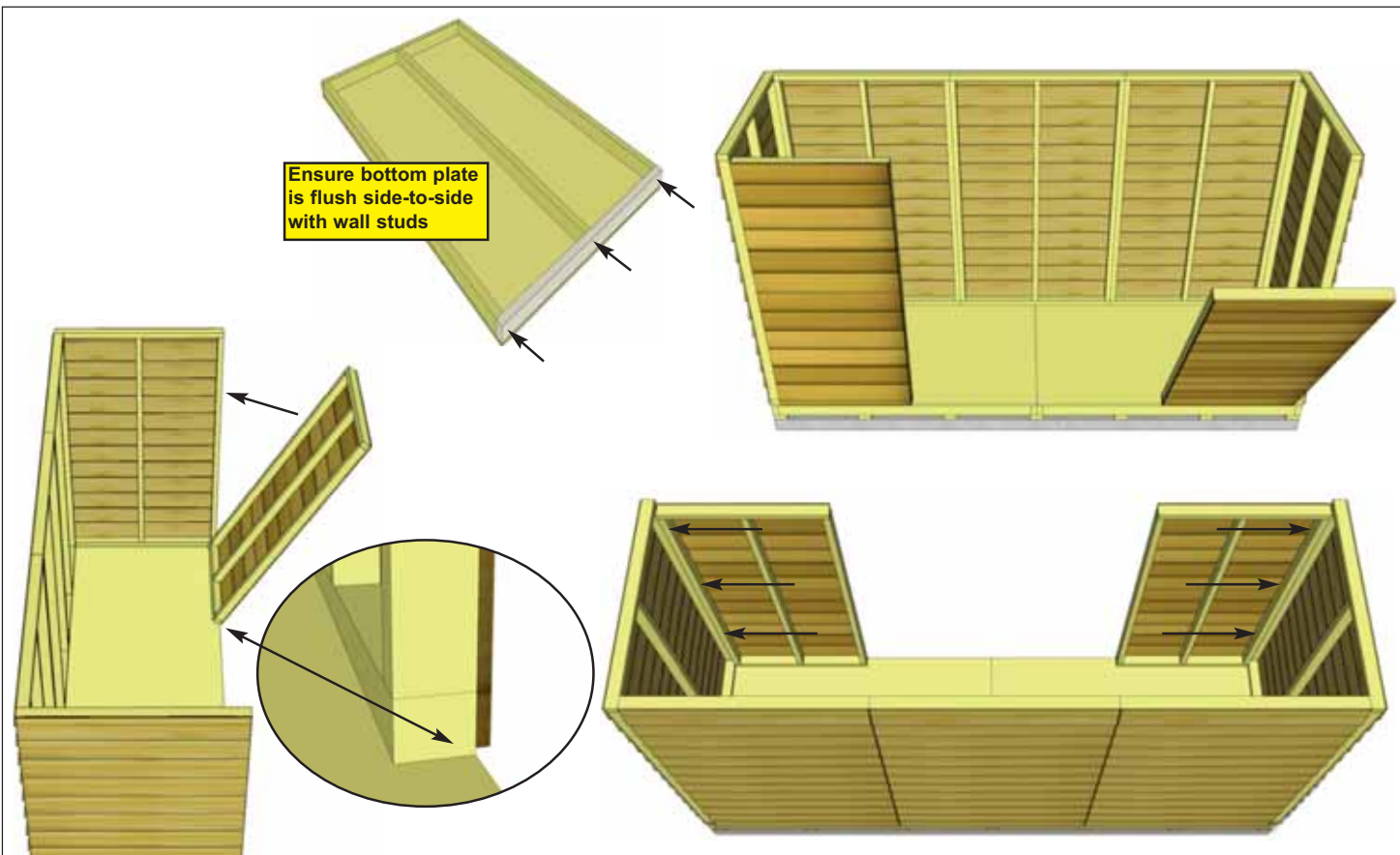

13. Carefully lay **2C - Front Wall Panels** face down. Position and attach **2BB - Bottom Wall Plates** to bottom of wall studs of each wall panel with **3 - 2 1/2" Screws** as per **Step 7**. Complete other remaining Front Wall.

Place Front Walls so wall framing is flush with floor frame and siding overhangs. Attach with **3 - 2 1/2" Screws** per panel as per **Steps 10 - 12.**

Parts

2C - Front Wall Panels
(35" wide x 73" high) x 2
2BB - Bottom Wall Plates
(1 5/8" x 2 1/2" x 35") x 2

Hardware

S1 - 2 1/2" Screws x 12 total

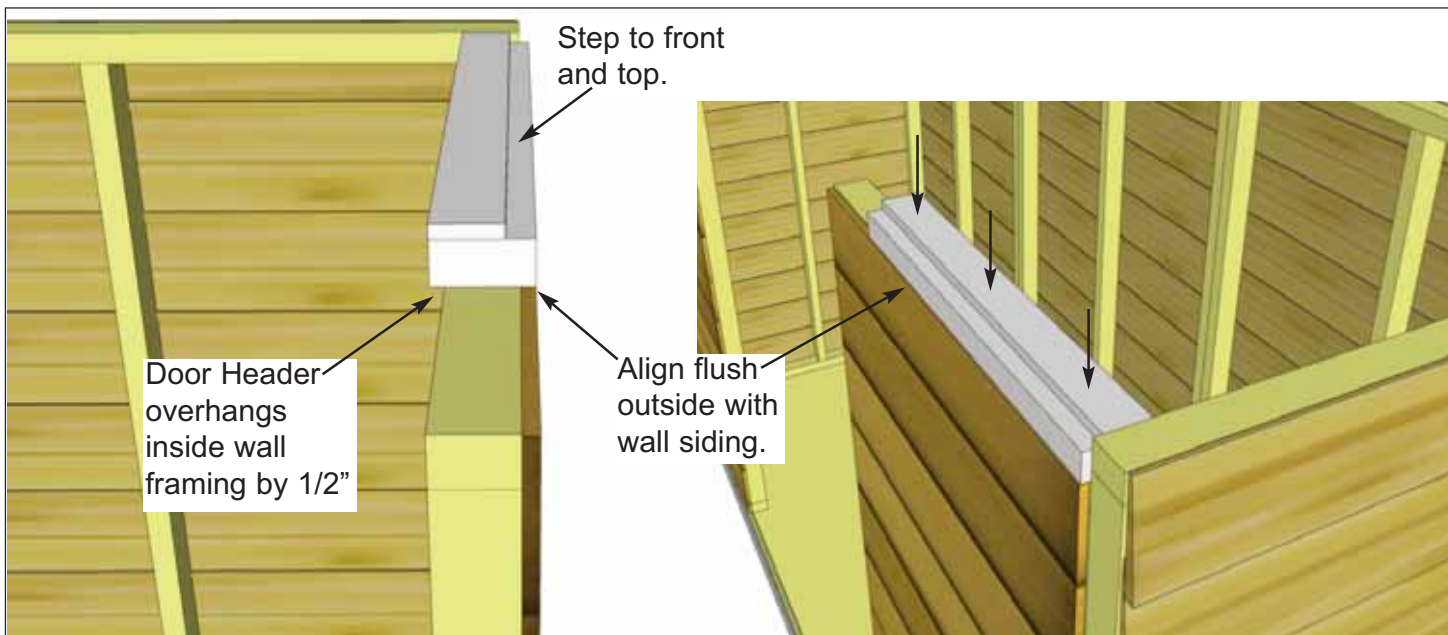

14. Position **2D - Door Header - Short** on top of wall stud so it is flush on the outside with the wall siding. Attach by screwing down into top wall framing with **3 - 3" Screws**.

Parts (Step 14 - 15)
2D - Door Headers - Short
 (2" x 3 1/2" x 26 1/4") x 2
2E - Door Header - Long
 (2" x 3 1/2" x 84") x 1

Hardware (Step 14 - 15)
S4 - 3" Screws
 x 10 total
S2 - 1 1/4" Screws
 x 4 total

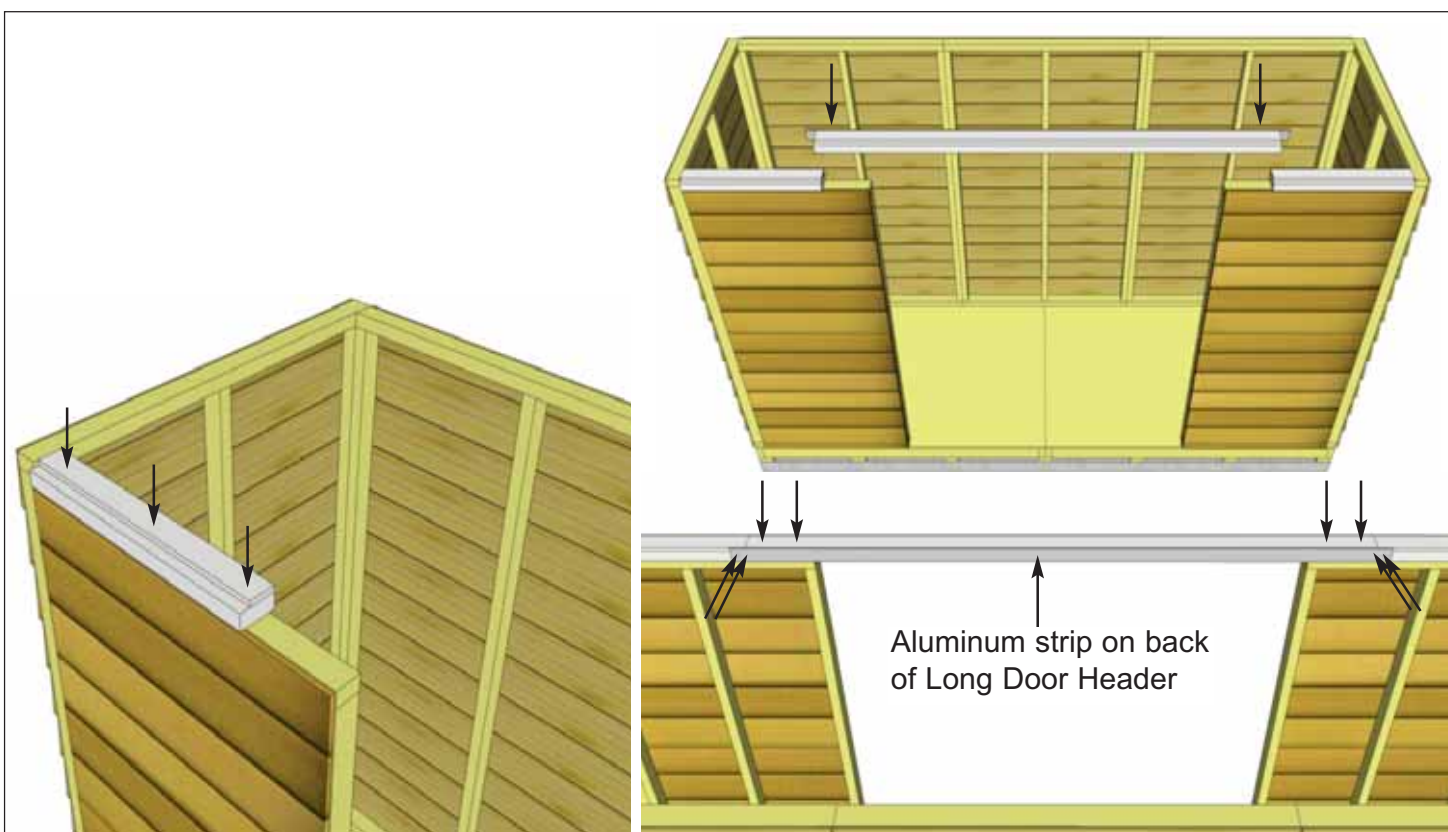

15. Attach **2D - Door Header - Short** to other side. Position and attach **2E - Door Header - Long** between short door headers. The Long Door Header has an aluminum strip attached to the back for added support. Attach by screwing down into wall framing with **2 - 3" Screws** per side. Fasten aluminum strip to short headers with **2 - 1 1/4" Screws** per side.

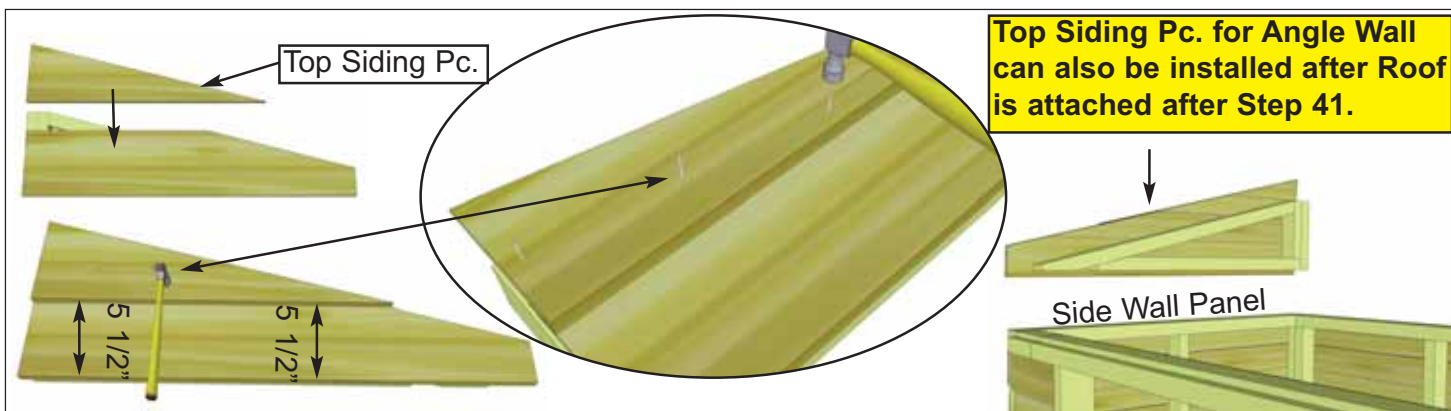

16. Position **2F - Top Triangular Siding Piece** onto **2G - Angle Wall Extender** and align as shown above. Attach with **3 - 1 1/2" Finishing Nails** to top frame of extender wall. There are left/right top siding pieces. Use rough surface side out. Place finished wall extender on side wall panel frame. Complete both sides now.
Note: Bottom siding of wall extender will overhang and cover siding of side wall.

<p><u>Parts</u></p> <p>2G - Angle Wall Extenders - L/R (2G - 45 1/2" wide) x 2</p> <p>2F - Top Triangular Siding Piece (2F - Left/Right) x 2</p> <p><u>Hardware</u></p> <p>N1 - 1 1/2" Finishing Nails x 6 total</p>

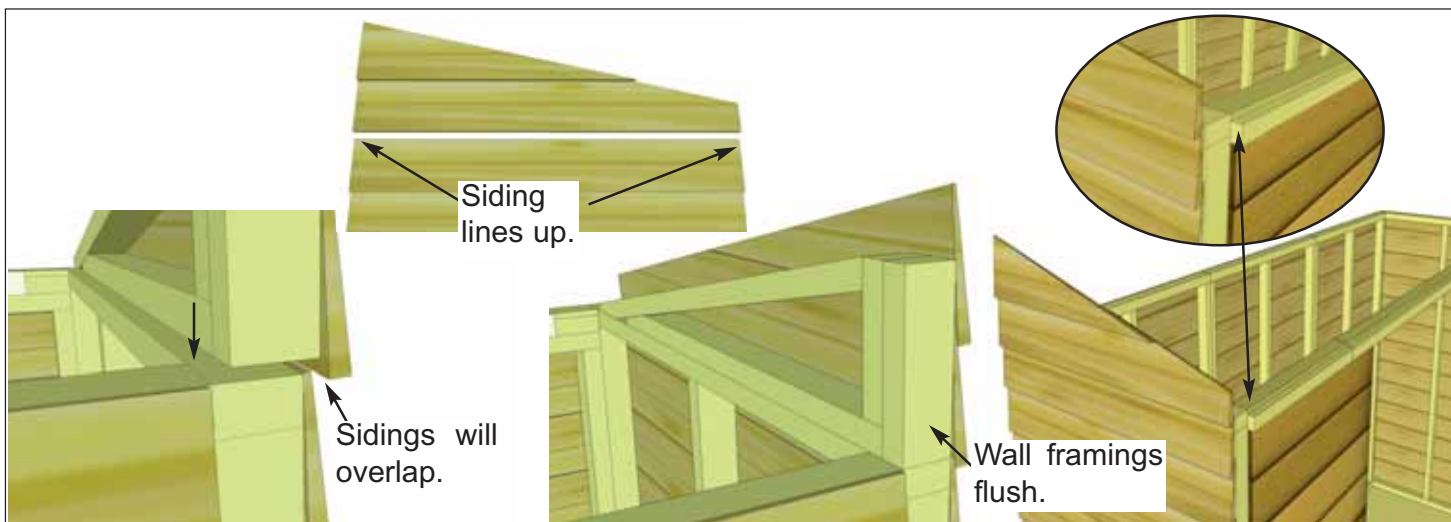

17. Align wall framing of Angled Wall Extender and Side Wall so they are flush at the back. The siding for both walls should also align evenly from front to back.



18. With Angled Wall Extender and Side Wall aligned correctly, secure together from the inside with **4 - 2 1/2" Screws**.

<p><u>Hardware (Steps 18 - 19)</u></p> <p>S1 - 2 1/2" Screws x 8 total</p>



19. Complete opposite Angled Wall Extender positioning and attachment as per **Step 18**.

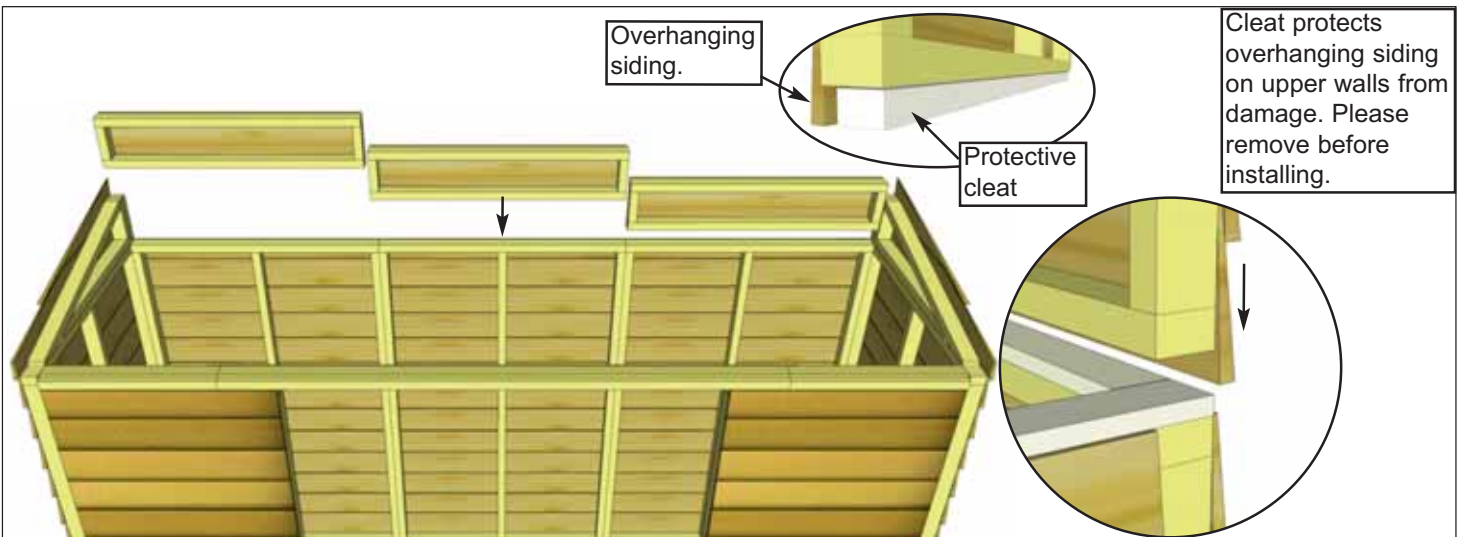

20. Place **2H - Rear Extender Walls** top framing of rear wall with bottom siding overlapping that of the rear wall.

Parts (Steps 20 - 21)
2H - Rear Extender Walls
 (2H - 45 1/2" wide) x 3

Hardware (Steps 20 - 21)
S1 - 2 1/2" Screws
 x 12 total

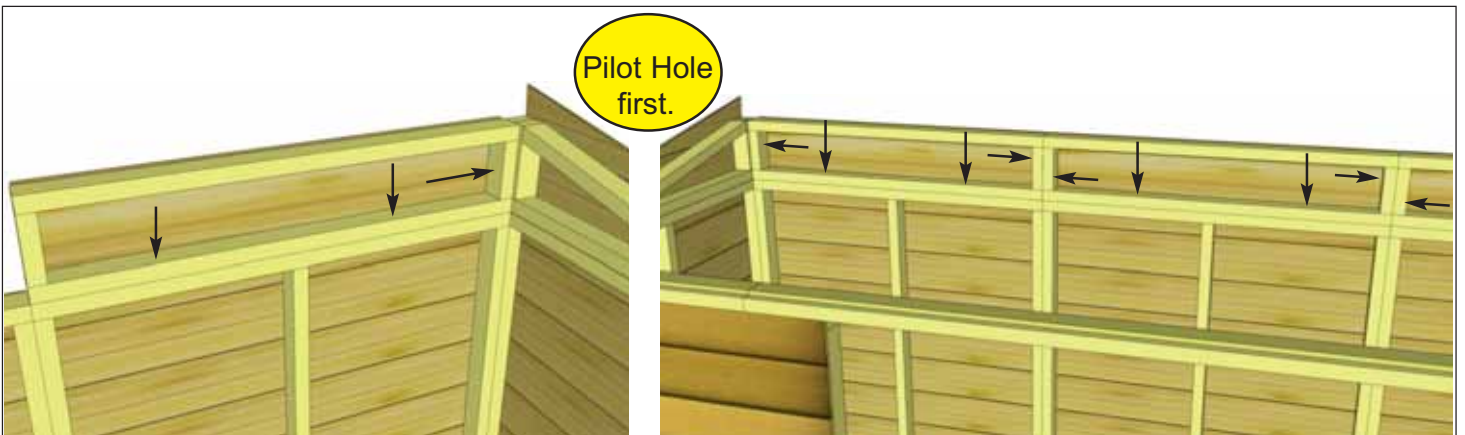

21. With 2x3 wall framing aligned, attach extender walls to rear wall top plate with **4 - 2 1/2" Screws** per wall.

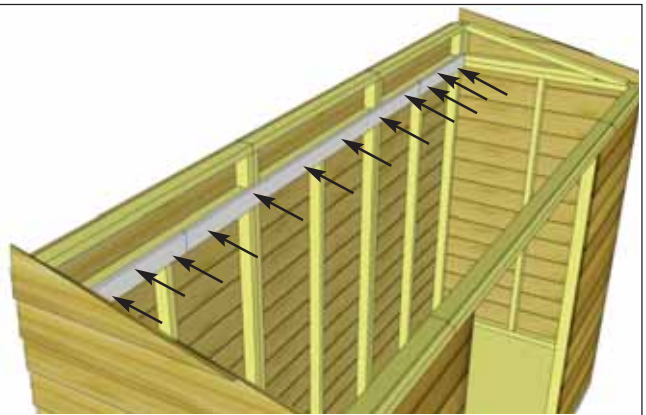
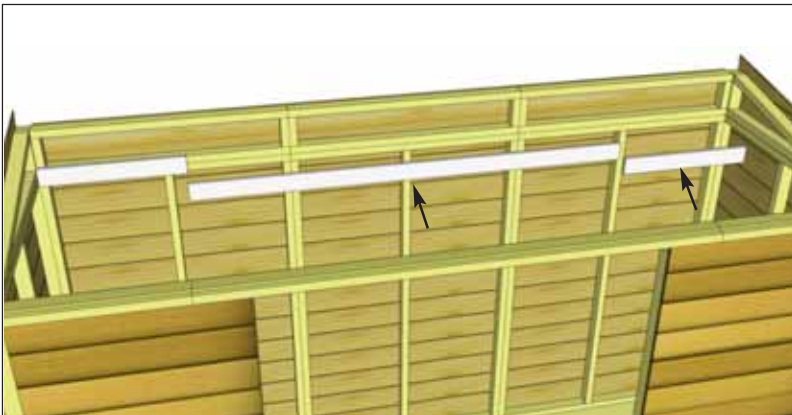

22. Attach **2I & 2J - Horizontal Wall Cleats** to Wall Extender bottom framing and Rear Wall top framing so that cleat is flush with extender framing. There are two short cleats and one long cleat. Alternate alignment of screws, so half screw into Wall Extender Framing and half into Rear Wall Top Framing. Use **3 - 1 1/4" Screws** per short cleat and **6 - 1 1/4" Screws** on the long cleat.

Parts	
2I - Horizontal Wall Cleat - Long (3/4" x 3 1/2" x 84")	x 1
2J - Horizontal Wall Cleats - Short (3/4" x 3 1/2" x 26 1/4")	x 2
Hardware	
S2 - 1 1/4" Screws	x 12 total

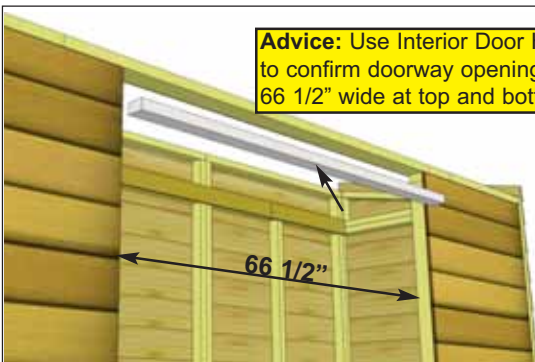

Advice: Use Interior Door Header to confirm doorway opening is 66 1/2" wide at top and bottom.

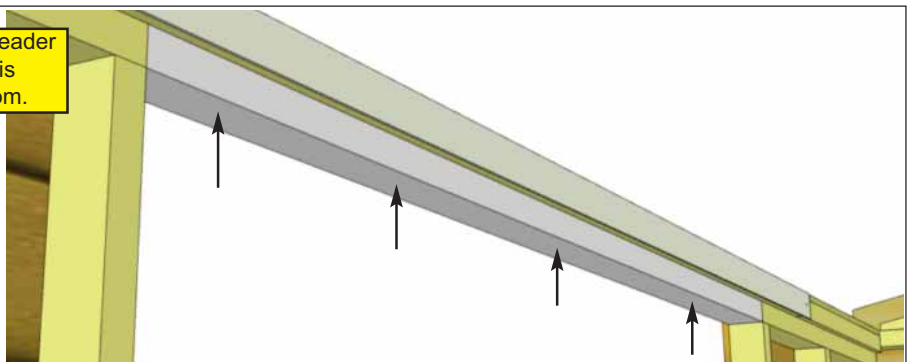

23. Attach **2EE - Interior Door Header** as shown above. Align with top framing of front walls. Attach with **4 - 2 1/2" Screws**. To complete Wall Section, attach bottom 2x3 wall plates to plywood floor with **2 - 2 1/2" Screws** per wall section. Prior to securing, make sure wall panels are aligned correctly on the floor. Refer to **Step 9**. Wall siding should overhang floor while 2x3 wall plates should sit flush with floor.

Parts	
2EE - Interior Door Header (1 1/2" x 3" x 66 1/2")	x 1
Hardware	
S1 - 2 1/2" Screws	x 32 total

Optional - Caulking seams will help prevent moisture from entering at seam. Caulking not included in kit.

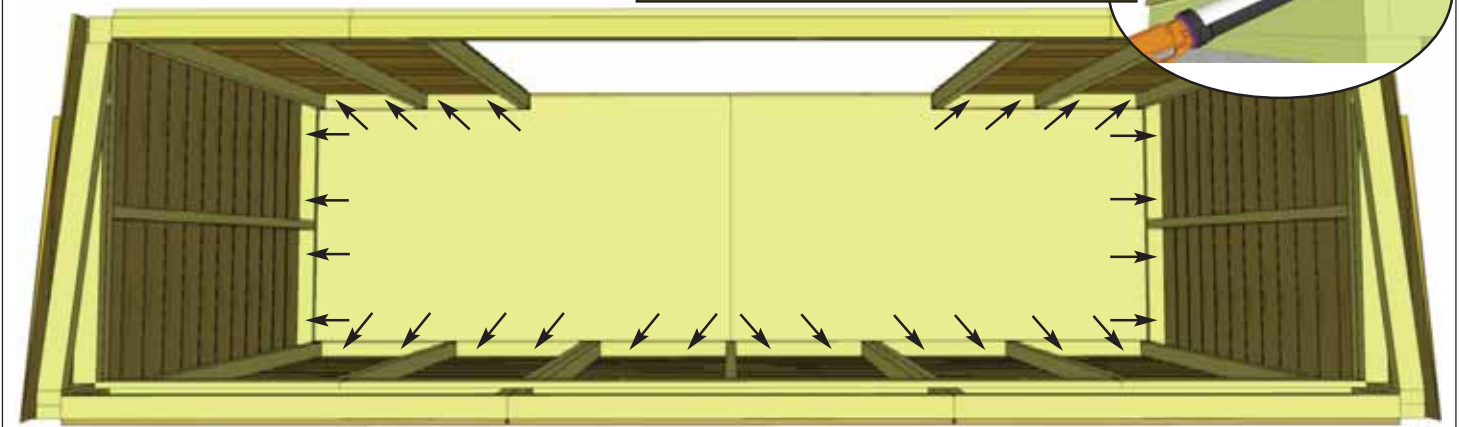

3. Rafter and Roof Section

Exploded view of all parts necessary to complete the Rafter and Roof Section. Identify all parts prior to starting.

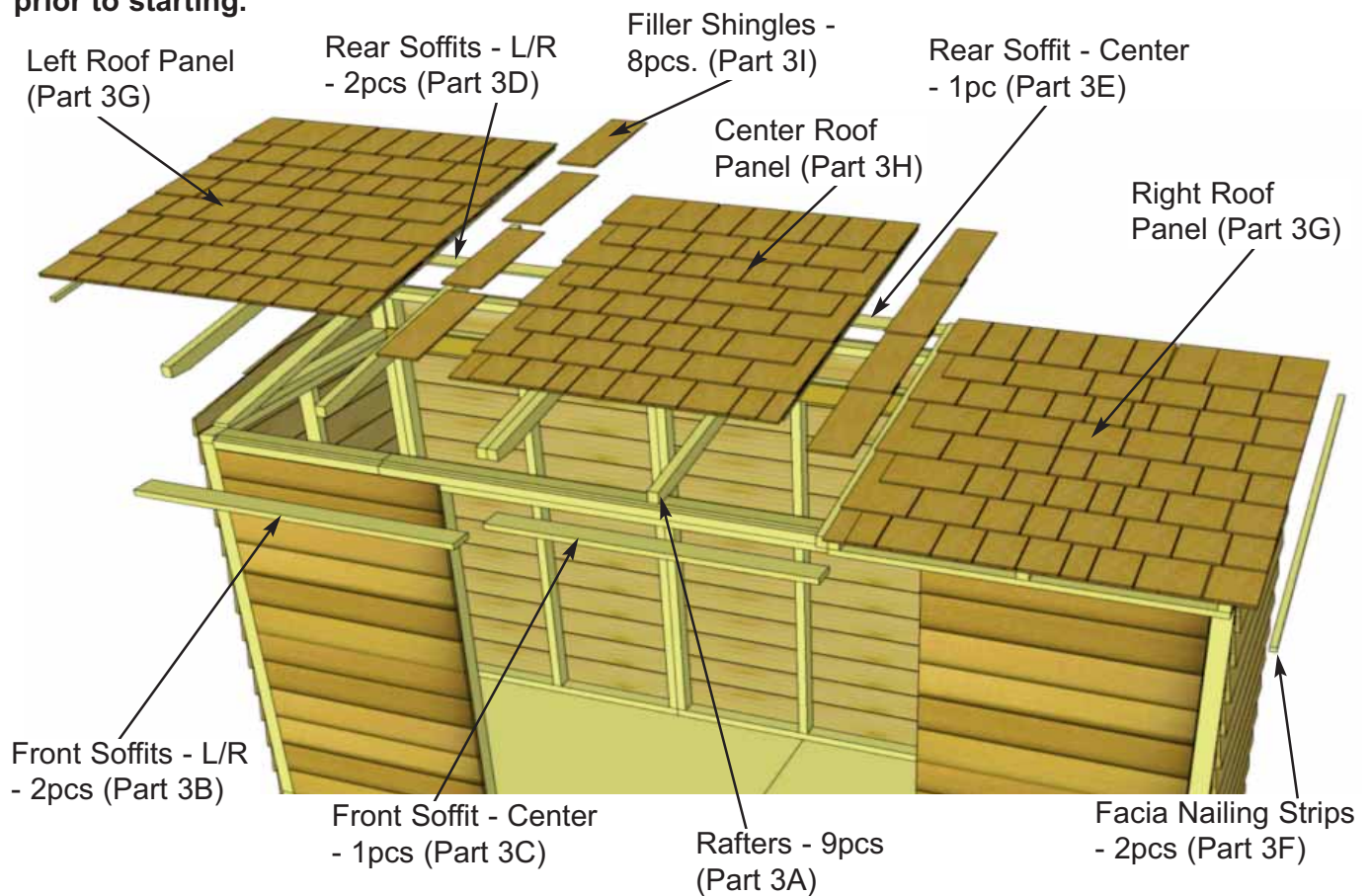

Advice: Prior to installing rafters, take time to confirm your walls are level, square and plumb.

Measure diagonal at top and bottom of walls corner-to-corner. This should be approximately 142 1/4". More importantly, if measurements are not within 1/4", your walls are not square.

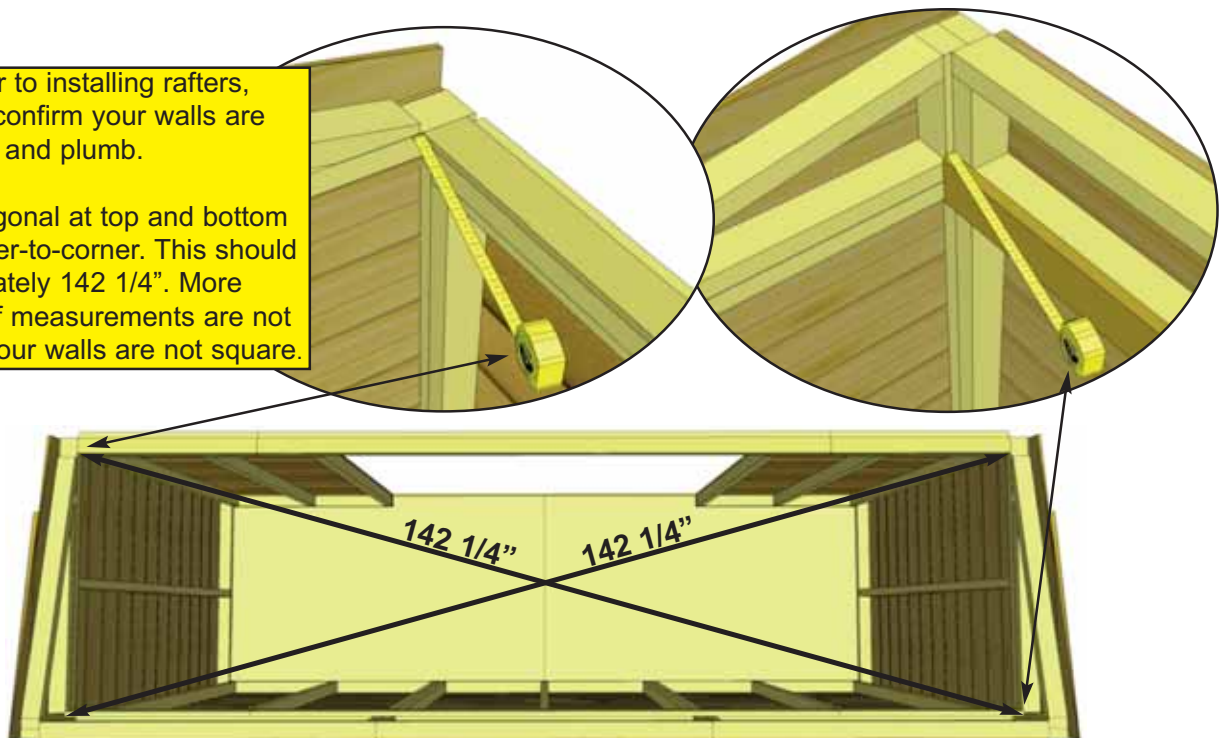

Note: We recommend you drill a 1/8" pilot hole for each screw, to avoid splitting wood. The hole depth should be equal to 3/4 the length of screw.

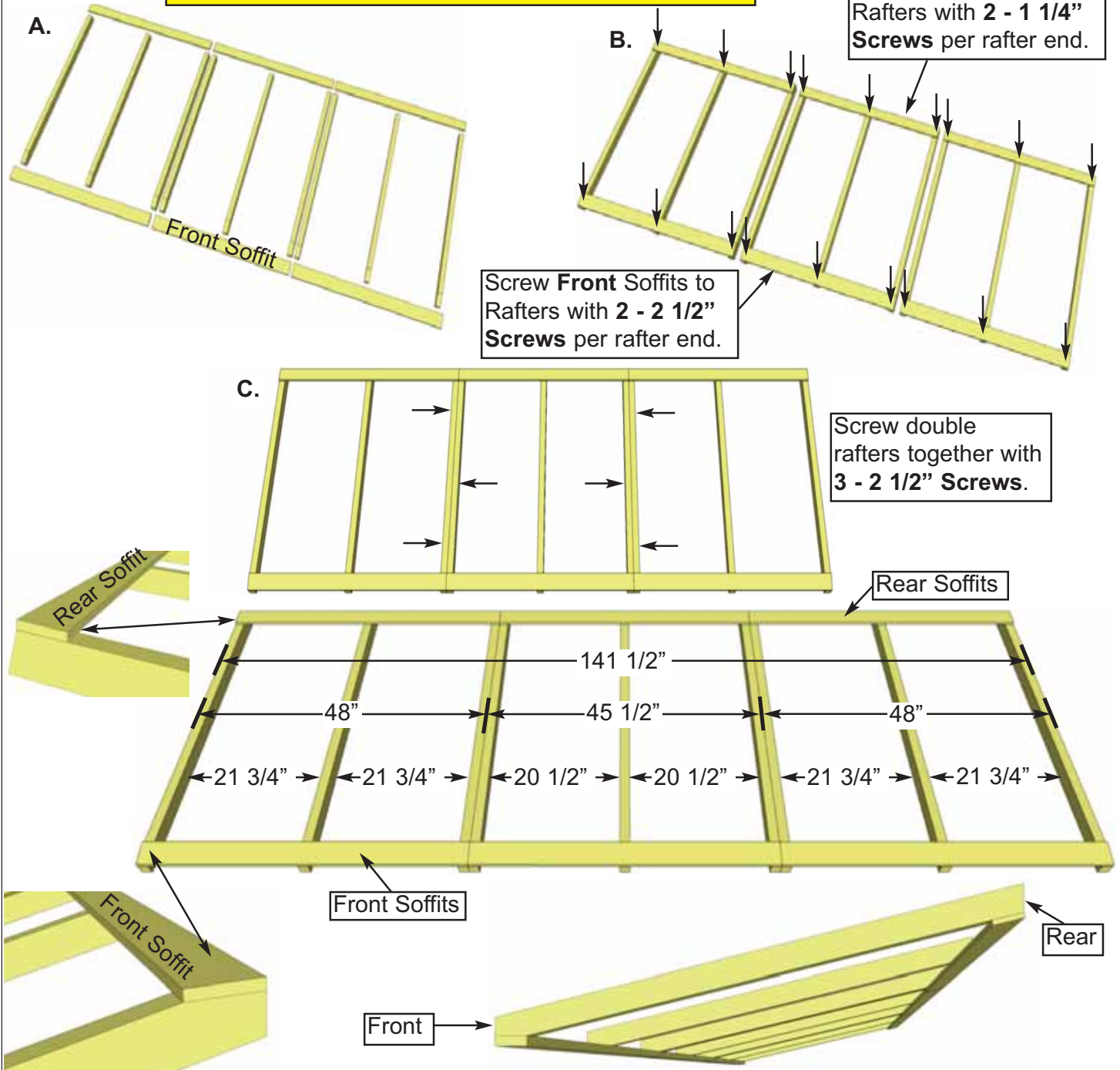

24. Locate **3A - Rafters**, **3B & 3C - Front Soffits** and **3D & 3E - Rear Soffits**. Lay out on level ground and assemble as shown above in Illustrations **A** through **C** below. Attach Soffit Boards flush to end of outside rafters. Attach Front Soffits with **2 - 2 1/2" Screws** per rafter end. Attach Rear Soffits with **2 - 1 1/4" Screws** per rafter end.

Important: Drill pilot holes in Soffit ends to prevent splitting. Attach double rafters as illustrated above with **3 - 2 1/2" Screws** per rafter/rafter connection.

Parts

3A - Rafters
(1 1/2" x 2 1/2" x 54") x 9
3B - Front Soffits - Sides
(1" x 3 1/2" x 48") x 2
3C - Front Soffit - Center
(1" x 3 1/2" x 45 1/2") x 1
3D - Rear Soffits - Sides
(1/2" x 3 1/2" x 48") x 2
3E - Rear Soffit - Center
(1/2" x 3 1/2" x 45 1/2") x 1

Hardware

S1 - 2 1/2" Screws
x 24 total
S2 - 1 1/4" Screws
x 18 total

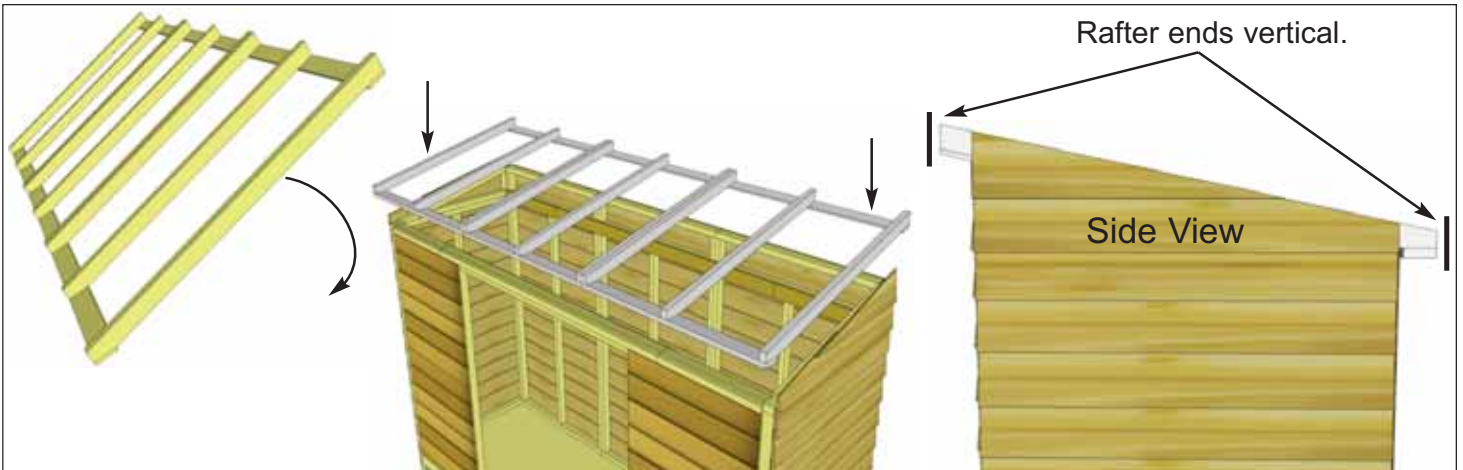

25. Carefully flip completed Rafter Section over so Front Soffit is facing the front and place on SpaceSaver walls. **Note:** Double check that your Rafter Section is positioned correctly by ensuring the ends of the Rafters are sloped vertically as shown above.

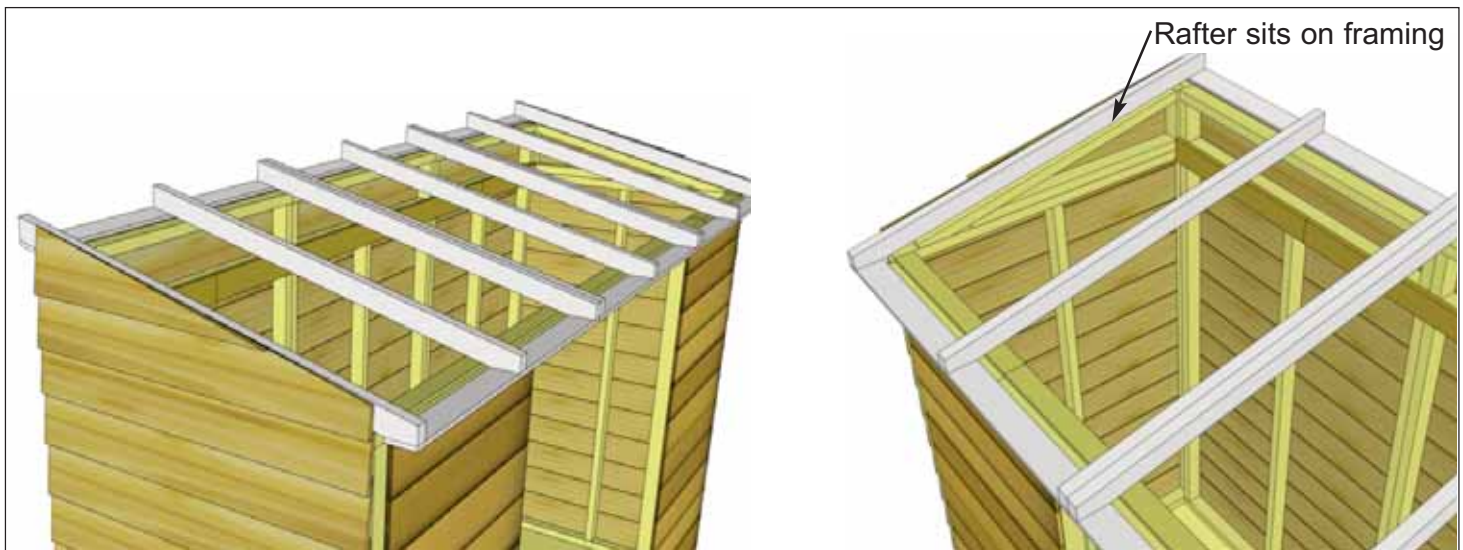

26. Position completed Rafter Section on top of walls. Outside Rafters will sit on Extension Wall framing and be positioned equally from side to side.



27. When Rafter Section is positioned correctly, both Front and Rear Soffits will sit approximately 1/8" away from wall siding. This can vary slightly.

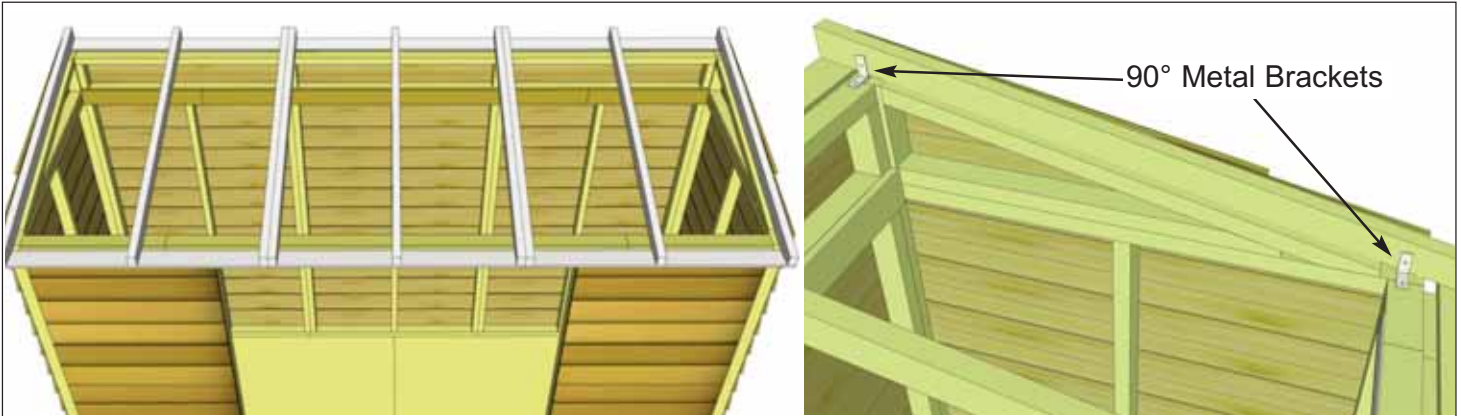

28. With Rafter Section correctly aligned, secure rafters to walls using **2 - 90° Metal Brackets** per side. Attach each brackets with **4 - 1 1/4" Screws**. Screw into Wall Extension Framing at the rear and Wall Panel top framing at the front. Complete both sides.

Hardware
Y2 - 90° Metal Bracket
 x 4 total
S2 - 1 1/4" Screws
 x 16 total

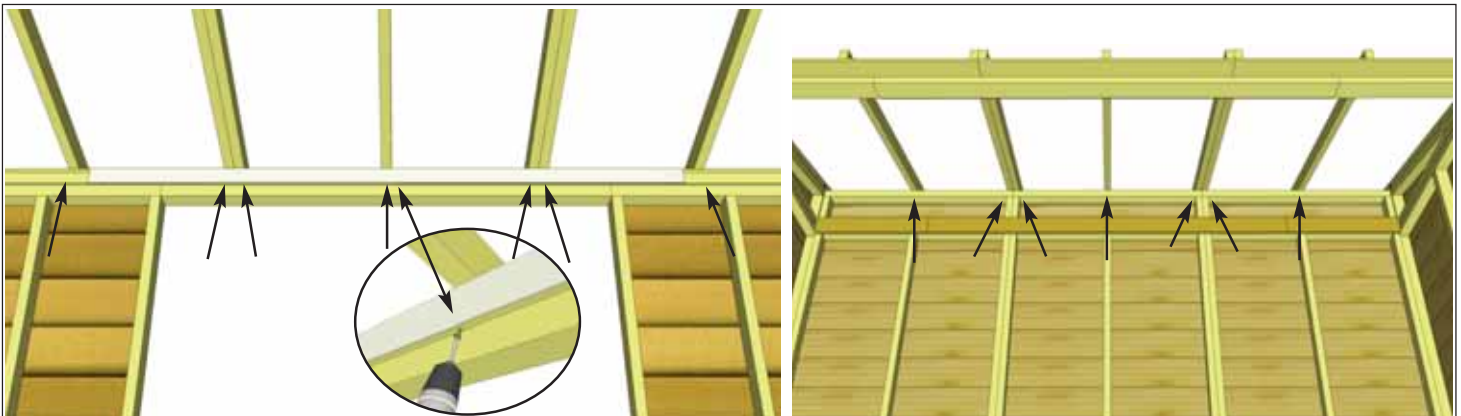

29. With outside rafters properly secured, attach remaining interior rafters using **1 - 3" Screw** per rafter end. Screw into rafters from inside of Header on an angle at front of shed, and from inside of Extender Wall Framing at rear of shed.

Hardware
S4 - 3" Screws
 x 14 total

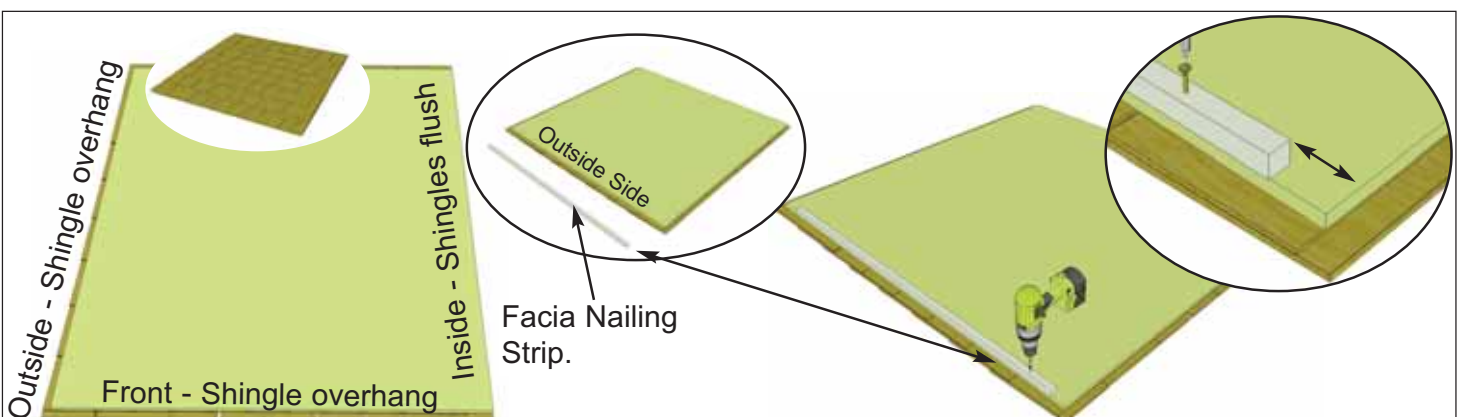

30. Carefully flip Roof Panels over so plywood sheathing is facing up. Center **3F - Facia Nailing Strips** onto outside of each panel flush with plywood. Attach with **4 - 1 1/4" Screws** evenly spaced. The Facia Nailing Strip provides for a greater nailing surface later when you attach side facia.

Parts
3F - Facia Nailing Strips
 (3/4" x 3/4" x 51") x 2

Hardware
S2 - 1 1/4" Screws
 x 8 total

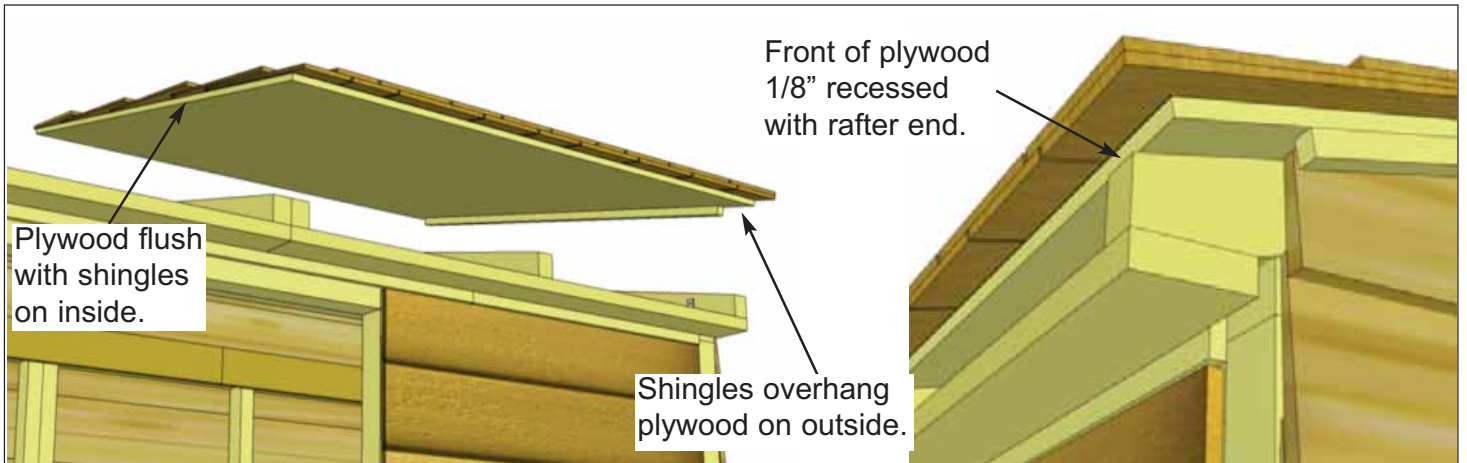

31. Correctly orientate **3G - Side Roof Panel**, with shingles overhanging plywood on the side of the shed and flush with plywood toward the center of the shed. Place on rafters with front of plywood just about flush with rafter ends but just slightly recessed. Doing so allows front fascia to sit better.

Parts (Steps 31 - 34)
3G - Left/Right Roof Panels
 (51" x 56") x 2
3H - Center Roof Panel
 (45 1/2" x 56") x 1

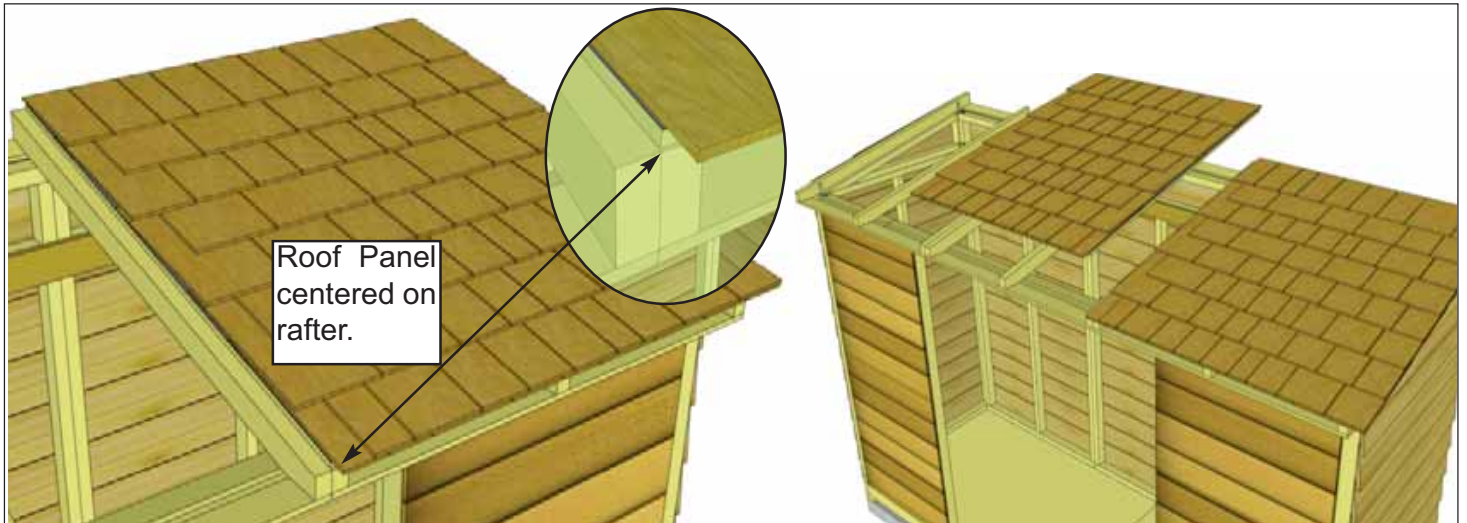

32. For correct Roof Panel position, align panel so plywood sits evenly on Center Rafters. Next, position **3H - Center Roof Panel** onto center rafters.

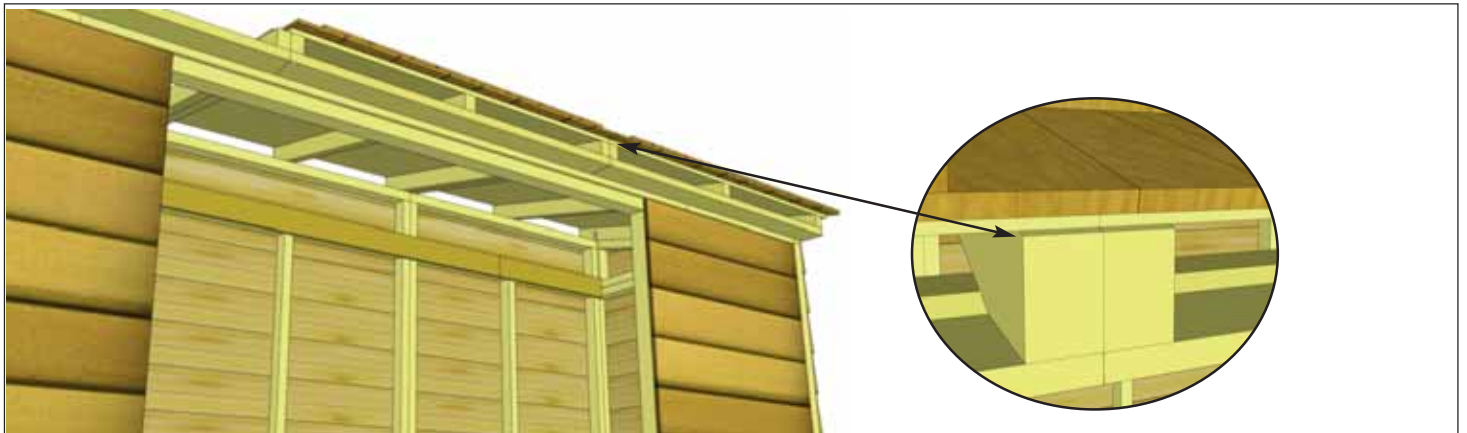

33. Align plywood of center roof panel so it is tight against the plywood of the side roof panel. Spacing should be even front and back.

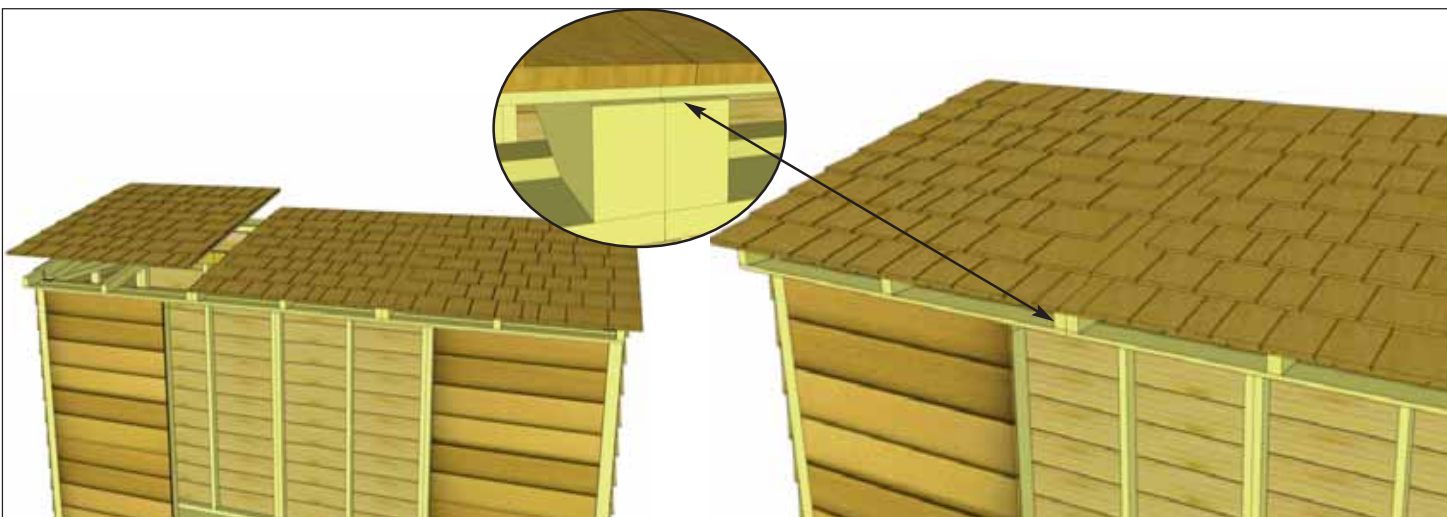

34. Position other side roof panel onto rafters as per **Steps 31 - 33**.

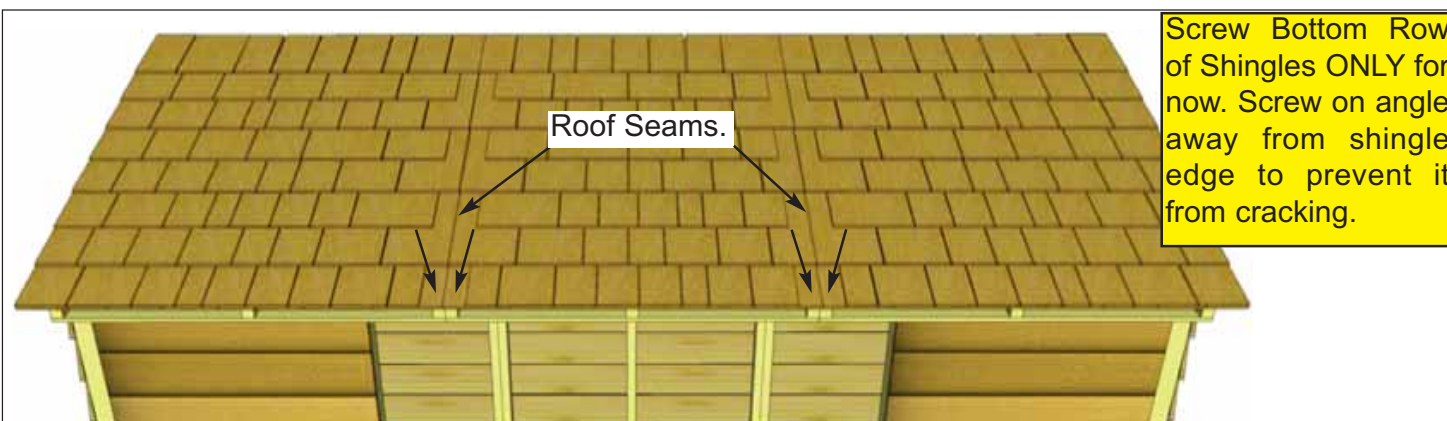

35. With Roof Panels aligned, screw panels down to center rafters with **2 - 2 1/2" Screws in Bottom Row of Shingles Only (1 screw per panel)**.

Hardware
S1 - 2 1/2" Screws
x 4 total

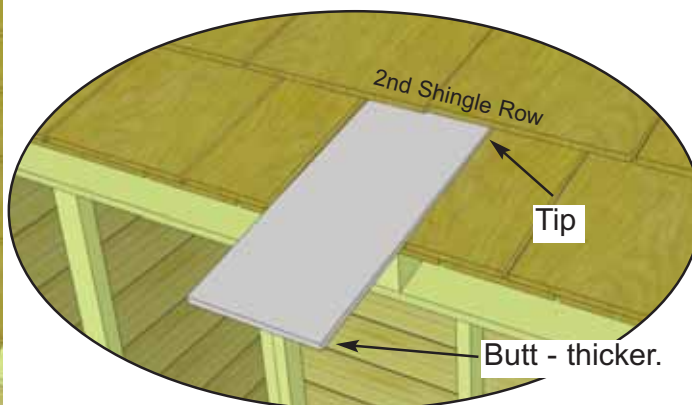
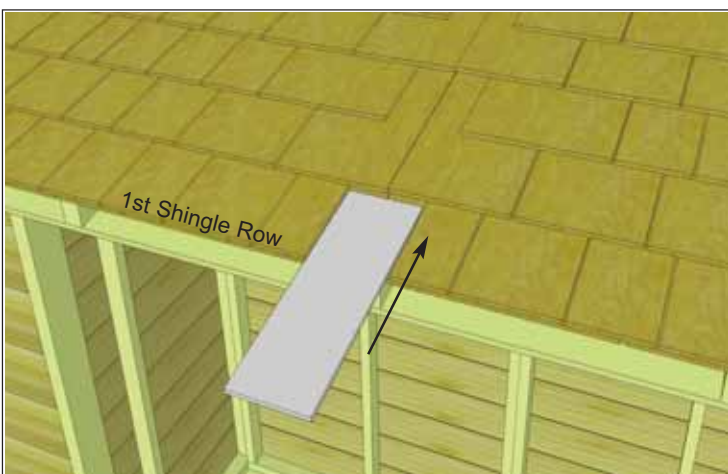

36. To cover roof seams, slide a **3L - Filler Shingle** up and underneath second shingle row. Push or bang filler carefully with a hammer until evenly spaced and butt is even with other 1st row of shingles. Do first filler shingle on both seams.

Parts (Steps 36 - 39)
3L - Filler Shingles
(16" - 18" Long) x 8

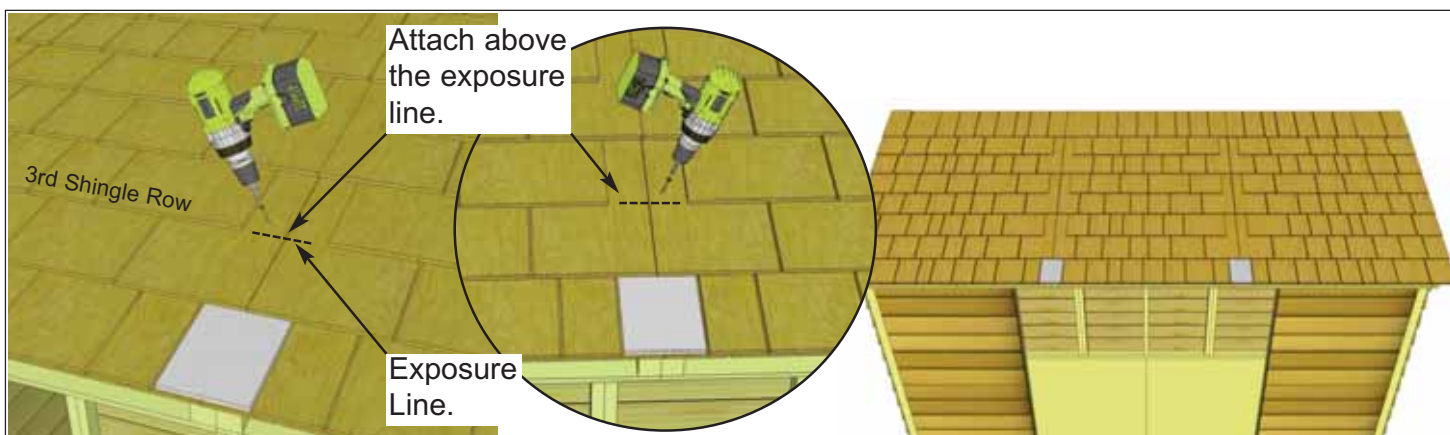

37. Screw first filler shingle down to rafters using **1 - 2 1/2" Screw** per panel (2 in total). Screw on slight angle and make sure to screw into rafter. Screw slightly above 3rd row of shingles (exposure line). This way, the screw will get covered up when you install your 2nd Filler Shingle and will prevent leaking. Do both roof seams the same.

Hardware
S1 - 2 1/2" Screws
x 4 total

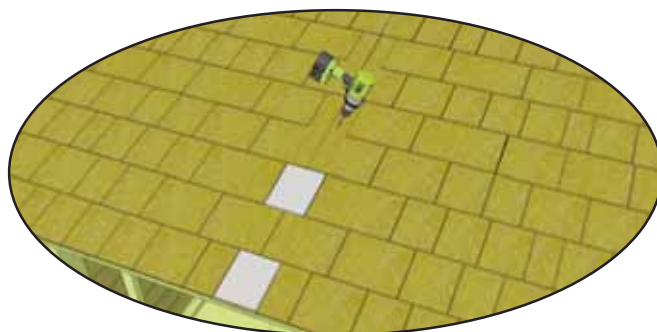
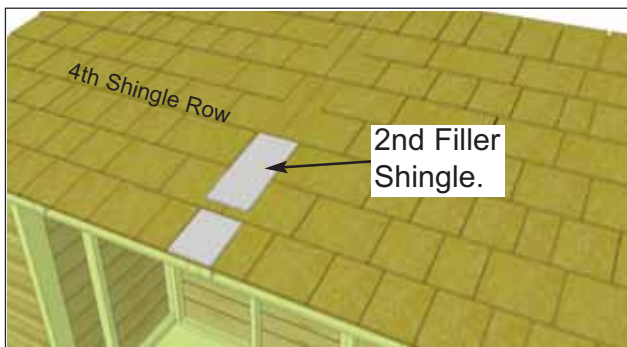

38. Slide 2nd **Filler Shingle** up and underneath fourth shingle row. Follow **Steps 36 - 37** to align and attach. Repeat for other roof seam.

Hardware
S1 - 2 1/2" Screws
x 4 total

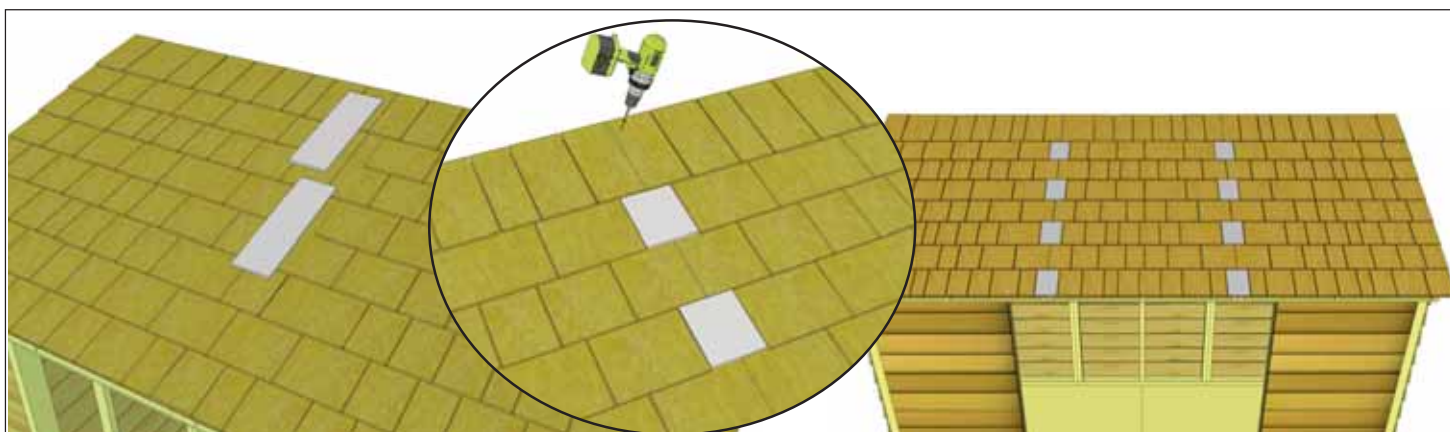

39. Slide 3rd and 4th **Filler Shingles** up and underneath appropriate shingle rows and follow **Steps 36 - 38** to align and attach. On last filler, screws will get covered by Roof Ridge Board (4 1/2" wide).

Hardware
S1 - 2 1/2" Screws
x 8 total

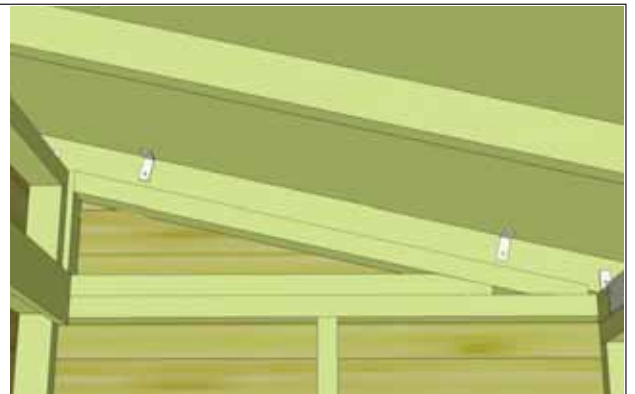
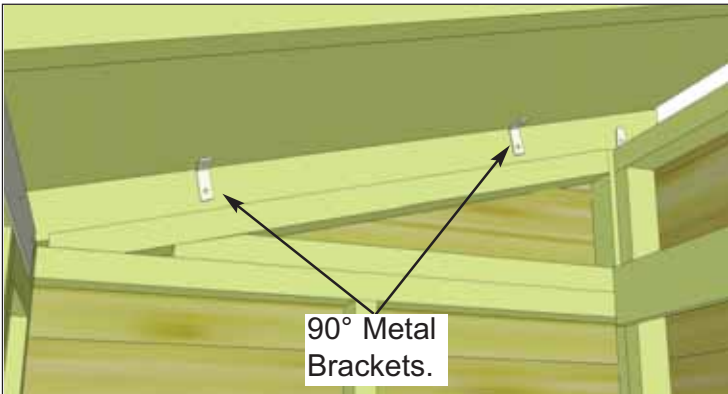

40. Secure roof panels to walls at both ends by positioning **2 - 90° Metal Brackets** on plywood and outside rafters and securing with **4 - 1 1/4" Screws** per Bracket. Complete both sides.

Hardware
S2 - 1 1/4" Screws x 16 total
Y2 - 90° Metal Brackets x 4 total

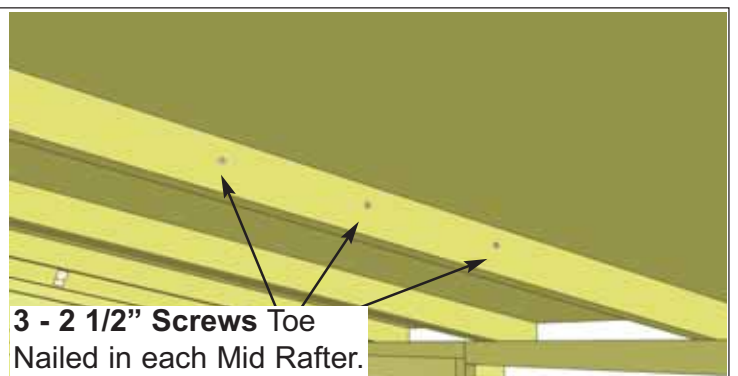
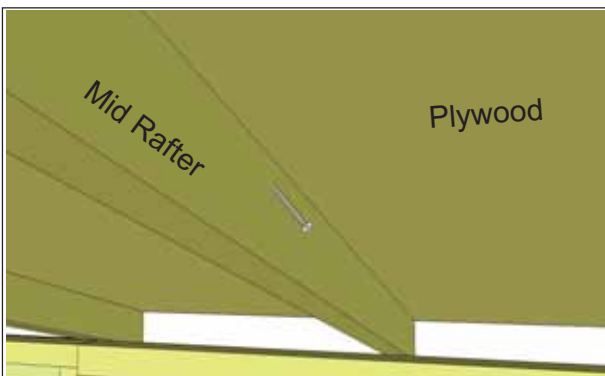

41. To further secure roof panels from the inside, drill pilot holes on an angle in each panel's Mid Rafter (3 per Rafter). Using **3 - 2 1/2" Screws**, secure rafters to plywood.
Note: from outside if possible, have a helper push roof panel down so plywood sits flush against rafter while securing.

Hardware
S1 - 2 1/2" Screws
 x 9 total

Note: If Top Siding Pc. for Angle Wall was not installed in Step 16 it can be done now. Attach with **3 - 1 1/2" Finishing Nails** per piece.

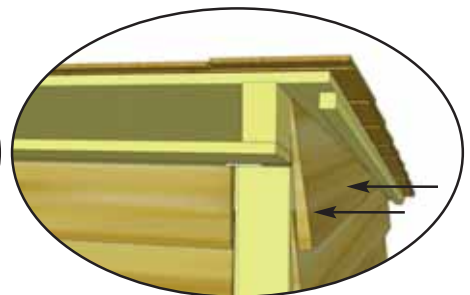
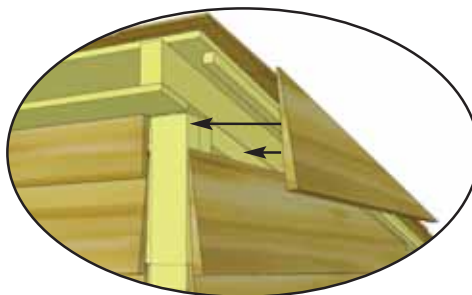

4. Trim & Miscellaneous Section

Exploded view of all parts necessary to complete the Skirting, Trim, Facia and Miscellaneous Pieces. Identify all parts prior to starting.

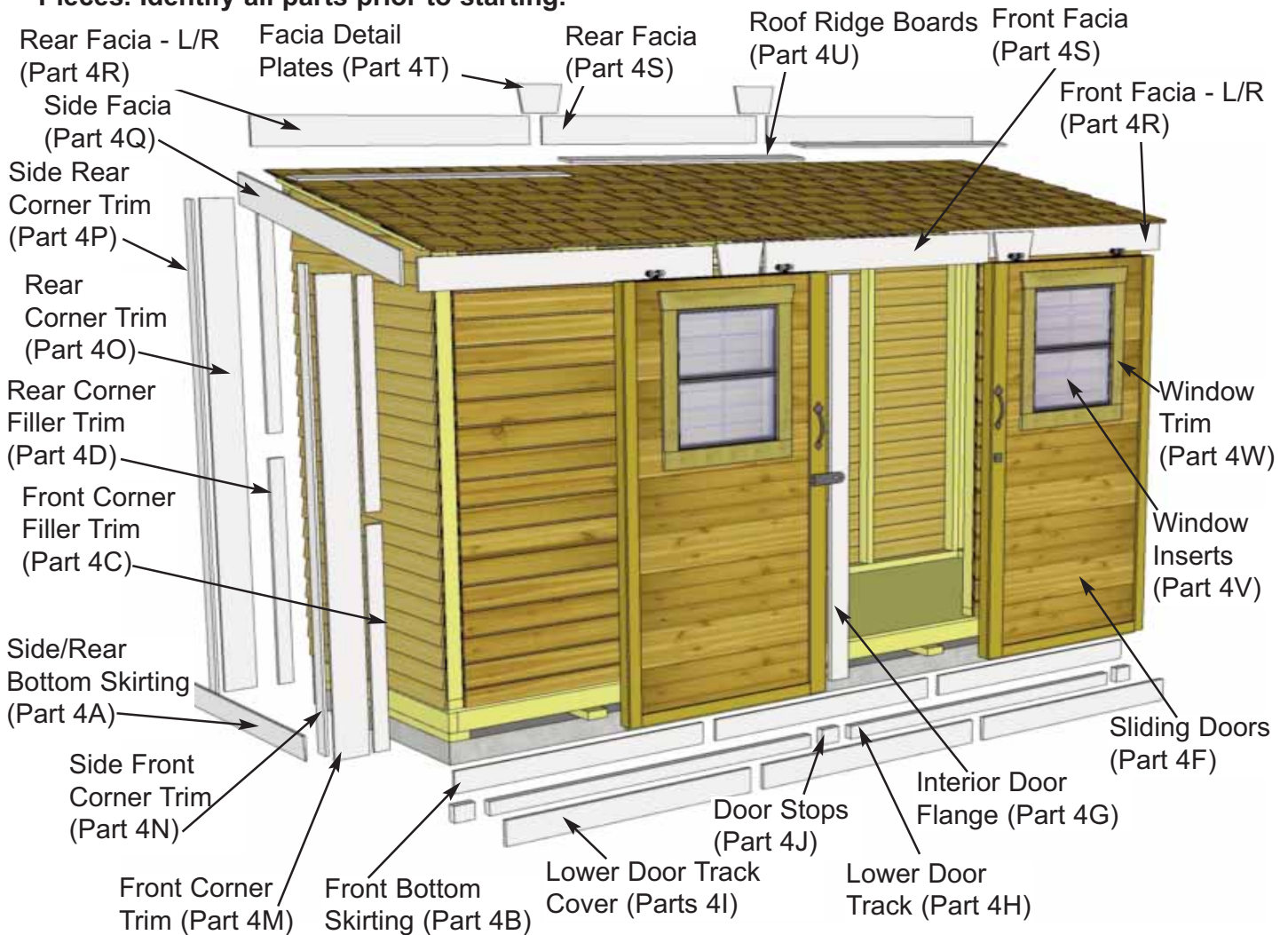

Note: All Trim, Facia, and Bottom Skirting pieces will be positioned rough face out when installed.

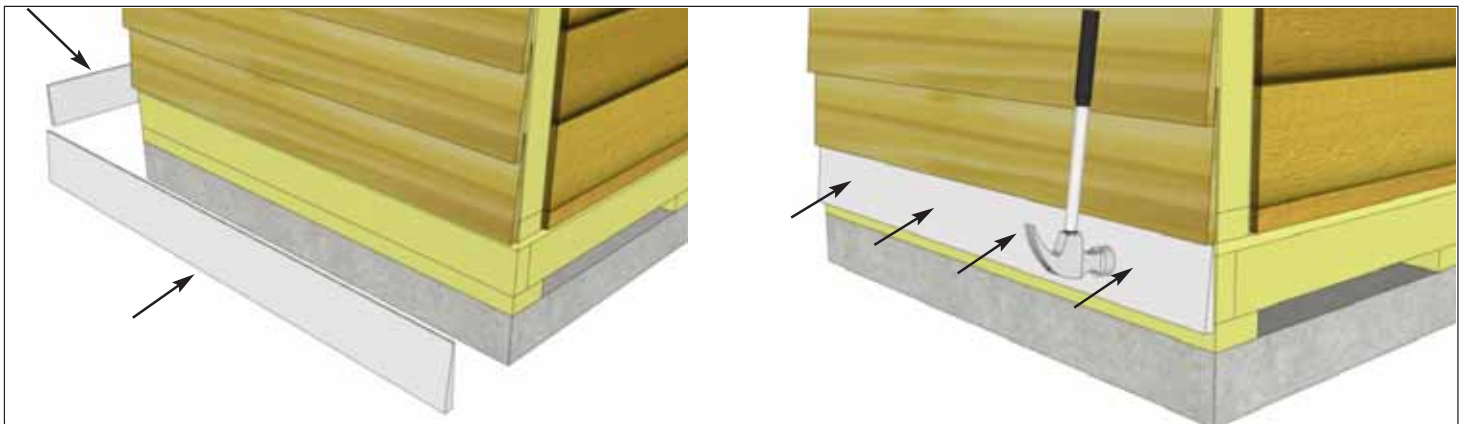

42. Attach 4A - Bottom Skirting around the base of the shed. Skirting will hide floor framing. Start with side skirting pieces first and attach with **4 - 1 1/2" Finishing Nails** per piece.

Parts (Steps 42 - 43)

4A - Side/Rear Bottom Skirting - Bevel
(1/2" x 4 1/2" x 45 1/4") x 5

Hardware (Steps 42 - 43)

N1 - 1 1/2" Finishing Nails x 20 total

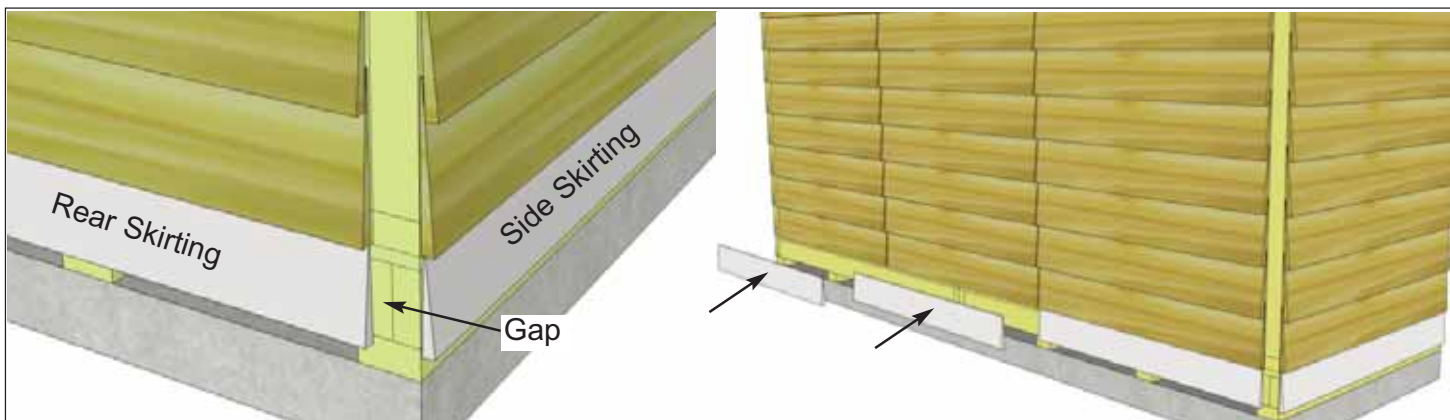

43. Gaps on outside will be covered by Corner Trim later. Complete side and rear skirting attachments.

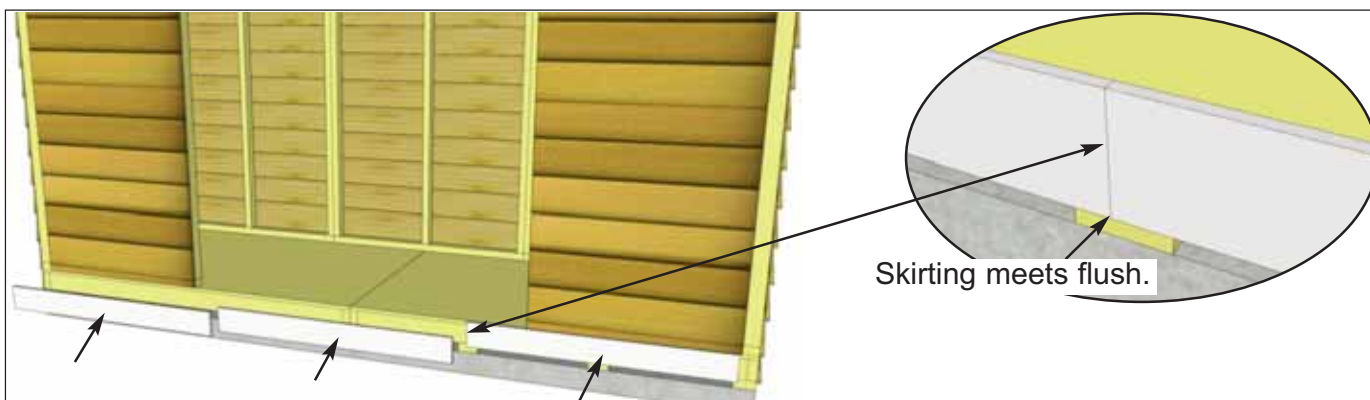

44. Attach **4B - Front Bottom Skirting** with **4 - 1 1/2" Finishing Nails** per piece as per **Steps 42 - 43.**

Parts
4B - Front Bottom Skirting
(1/2" x 4" x 45 1/4") x 3

Hardware
N1 - 1 1/2" Finishing Nails
x 12 total



45. Position and attach **4C - Front Corner Filler Trim** with **4 - 1 1/2" Finishing Nails** per piece. Filler trims won't be visible because they serve as nailing strips for the Corner Trims which will be attached later.

Parts
4C - Front Corner Filler Trim
(1/2" x 2 1/2" x 38") x 4

Hardware
N1 - 1 1/2" Finishing Nails x 16 total



46. Position and attach **4D - Rear Corner Filler Trim** with **5 - 1 1/2" Finishing Nails** per piece as per **Step 45**.

Parts
4D - Rear Corner Filler Trim
(3/4" x 2 1/2" x 42") x 4

Hardware
N1 - 1 1/2" Finishing Nails
x 20 total



47. Position **4E - Aluminum Door Tracks** on bottom of Front Soffits, spaced approximately 3/8" from Door Header. **4Y - Extra Piece Lap Siding** can be used as a spacer for track. Tracks should meet at the center of the door opening below middle rafter. Attach with **8 - 1 1/4" Screws** per track.

Parts
4E - Aluminum Door Track
x 2
Hardware
S2 - 1 1/4" Screws x 16 total

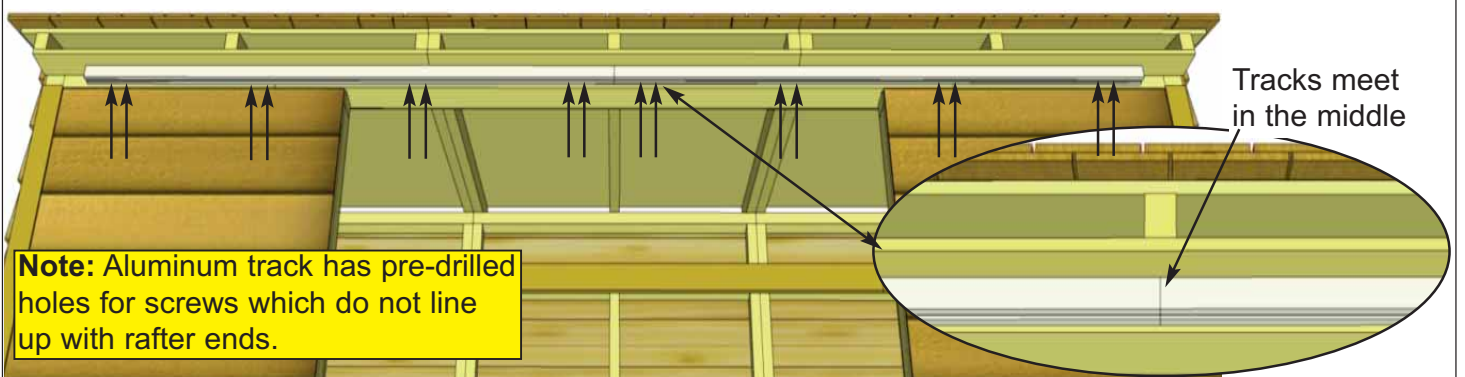

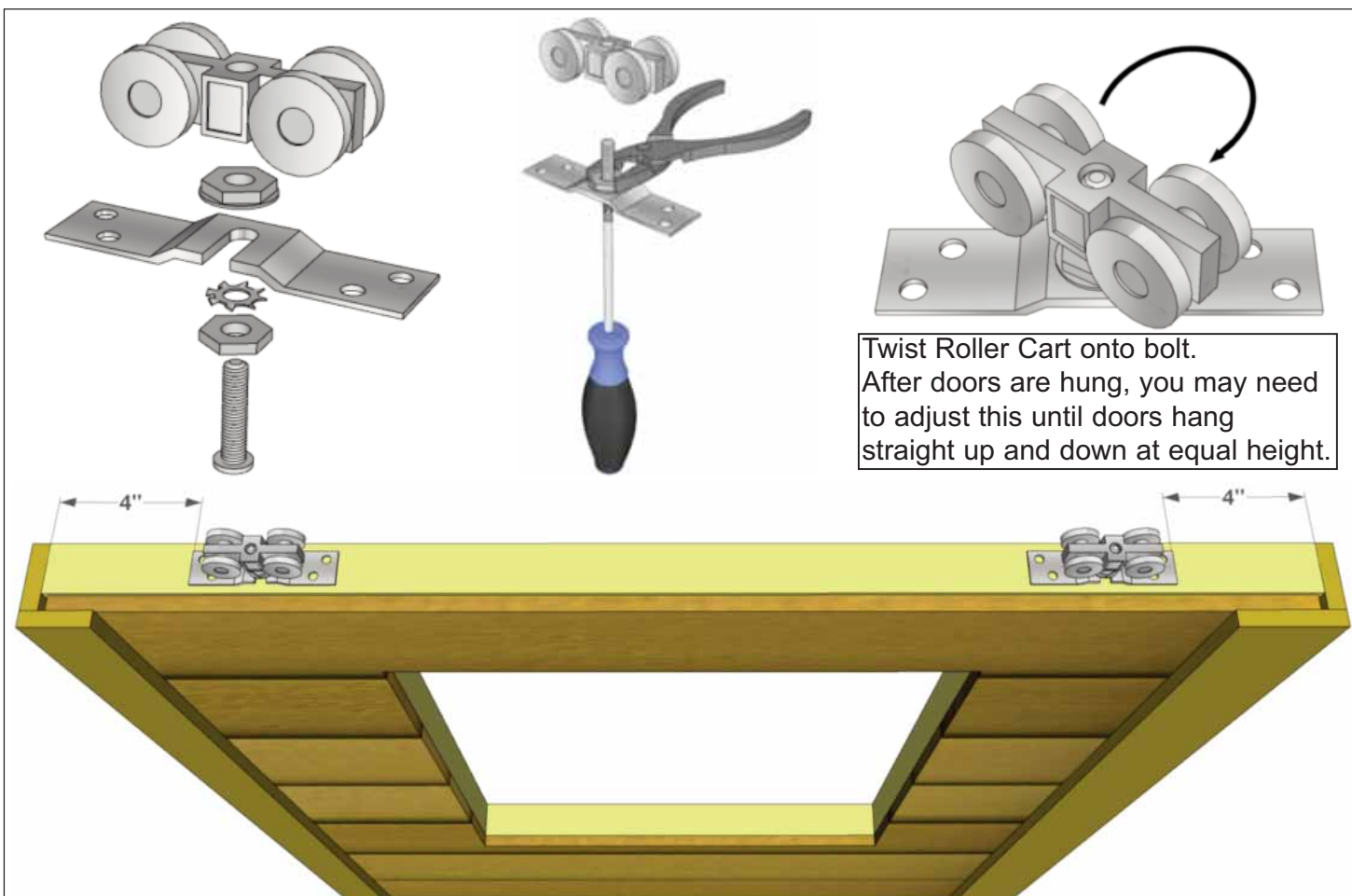

Twist Roller Cart onto bolt.
After doors are hung, you may need to adjust this until doors hang straight up and down at equal height.

48. Locate all four **Y35 - Roller Assemblies**. Before attaching to top of doors, assemble the units as shown above. Attach two Roller Assemblies to each door with **4 - 1 1/4" Screws** per Assembly, center on the door framing 4" from each end as shown above.

Next, take Left Side Door and slide Rollers into the Aluminum Door Track. Repeat with Right Side Door and slide until doors meet in the middle.

Parts
4F - Sliding Doors
(36" x 73") x 2

Hardware
S2 - 1 1/4" Screws x 16 total
Y35 - Roller Assembly x 4 total

Note: If there is a gap between your doors at the top or bottom, remove the door and twist the Roller Assemblies to adjust the height until they hang parallel.

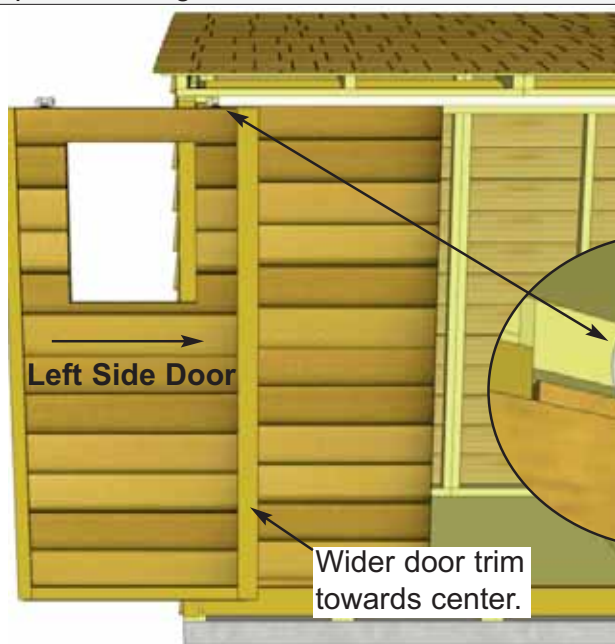

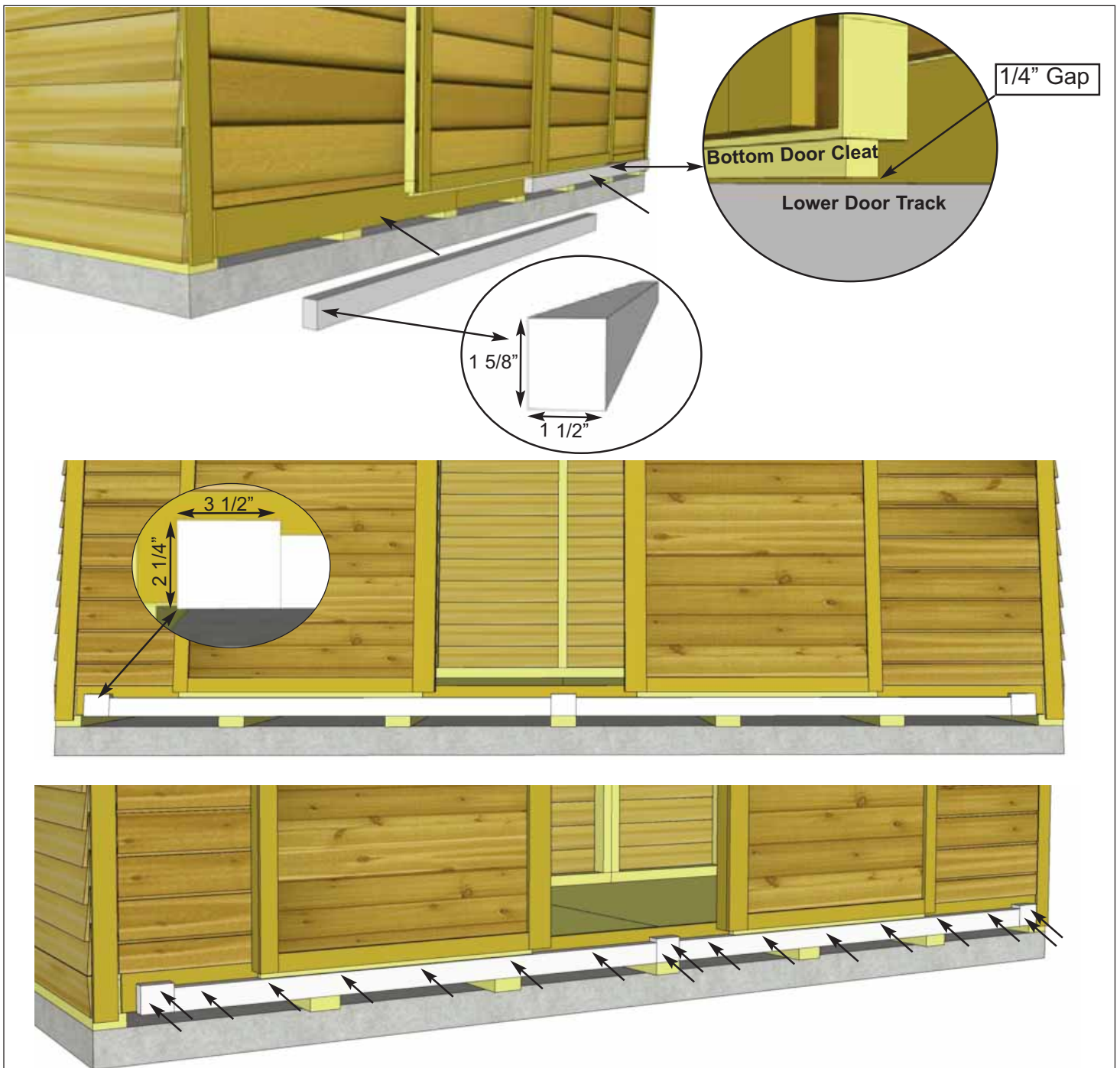

49. Locate **4H - Door Tracks** and **4J - Door Stops**. Middle Door Stop should be centered on shed and outer Door Stops should be 1 1/2" from edge of bottom skirting. Door Tracks rest on Long Floor Runners. Bottom of Door Stops and Door Tracks should be flush with each other. Secure Door Tracks to shed with **6 - 3" screws** per piece. Secure Door Stops with **2 - 3" screws** per piece.

Parts

4H - Lower Door Track
(1 1/2" x 1 5/8" x 61 1/8") x 2
4J - Door Track Stops
(1 1/2" x 2 1/4" x 3 1/2") x 3

Hardware

S4 - 3" Screws x 18 total

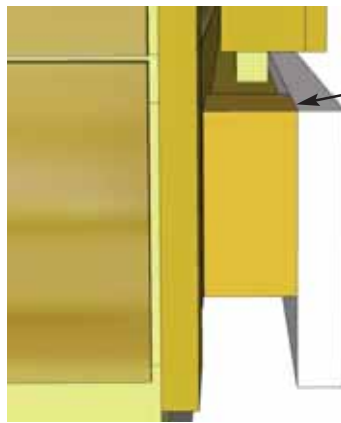
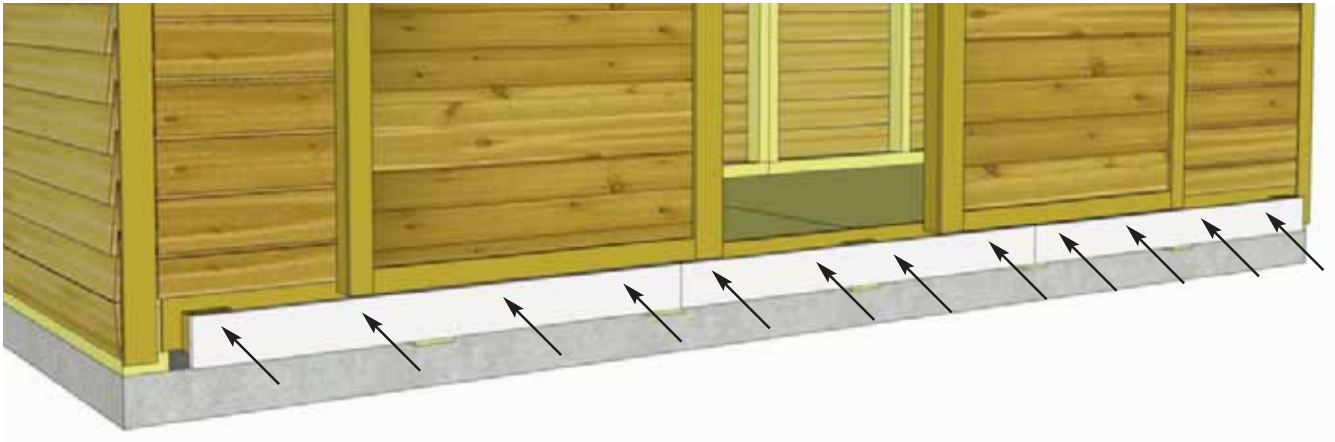

Door Stop and
Track Cover are
flush



50. Locate **4I - Door Track Covers**. Lineup so Track Covers are flush with Door Stops. This creates an enclosure so doors can not slide out of the track. Secure each piece of Track Cover with **4 - 2 1/2" screws**.

Parts
4I - Lower Door Track Cover
(3/4" x 3 1/2" x 44 1/4") x 3

Hardware
S1 - 2 1/2" Screws
x 12 total

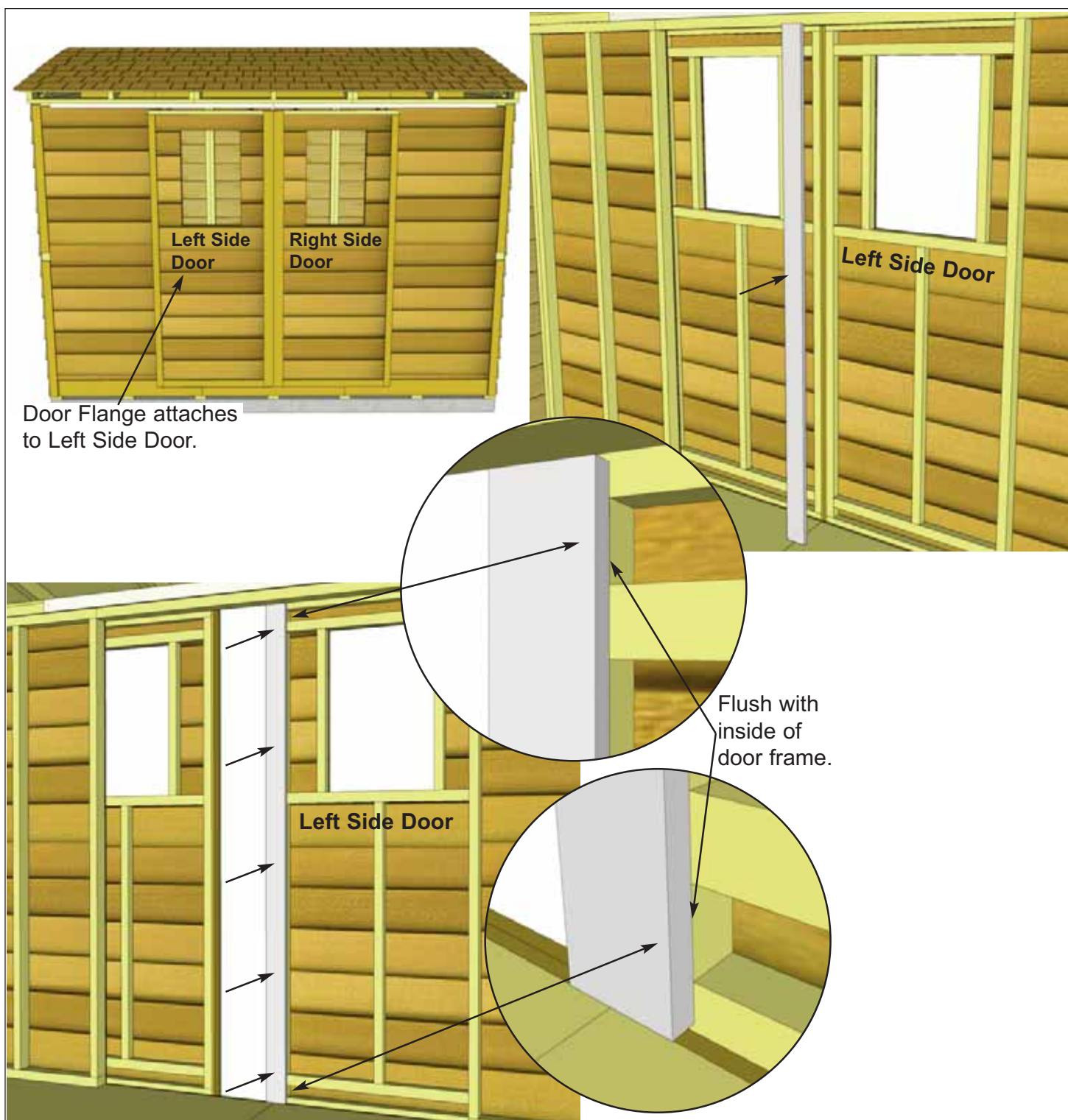

51. Position **4G - Interior Door Flange** on the rear of the left side door (when viewed from the front of the shed). Ensure flange is flush with the inside of the door frame and attach with **5 - 1 1/4" Screws**.

<p><u>Parts</u></p> <p>4G - Interior Door Flange (3/4" x 3 1/2" x 71 1/2") x 1</p>
<p><u>Hardware</u></p> <p>S2 - 1 1/4" Screws x 5 total</p>

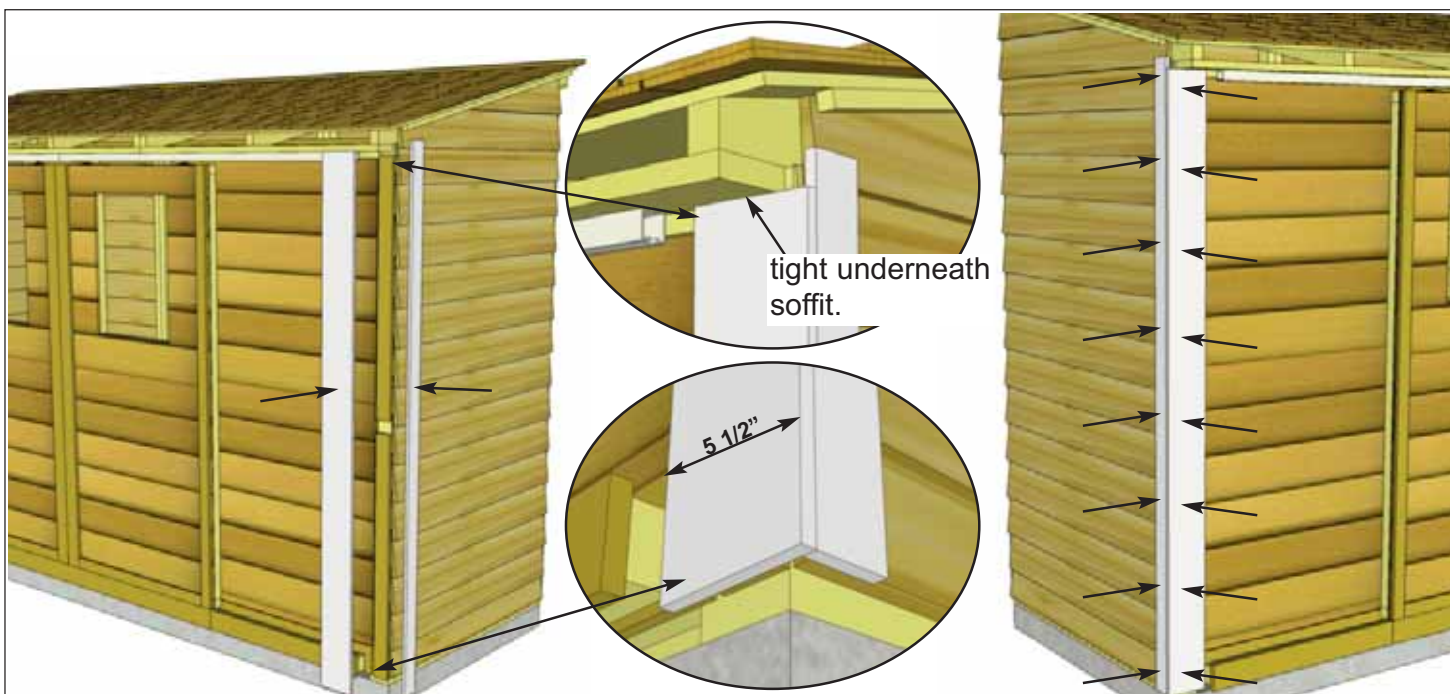

52. Place **4M & 4N - Front Corner Trims** in front corner and align as illustrated above. Do a dry run prior to attaching to achieve best fit. Start with 5 1/2" wide Front Corner Trim and align tight underneath soffit to determine vertical height. Attach with **8 - 1 1/2" Finishing Nails** per piece. Position and attach Side Front Corner Trim (2 1/2" wide) using **8 - 1 1/2" Finishing Nails**, aligning at bottom with wide trim.

Parts

4M - Front Corner Trims
(1/2" x 5 1/2" x 78 1/2") x 2
4N - Side Front Corner Trims
(1/2" x 2 1/2" x 80") x 2

Hardware

N1 - 1 1/2" Finishing Nails
x 32 total

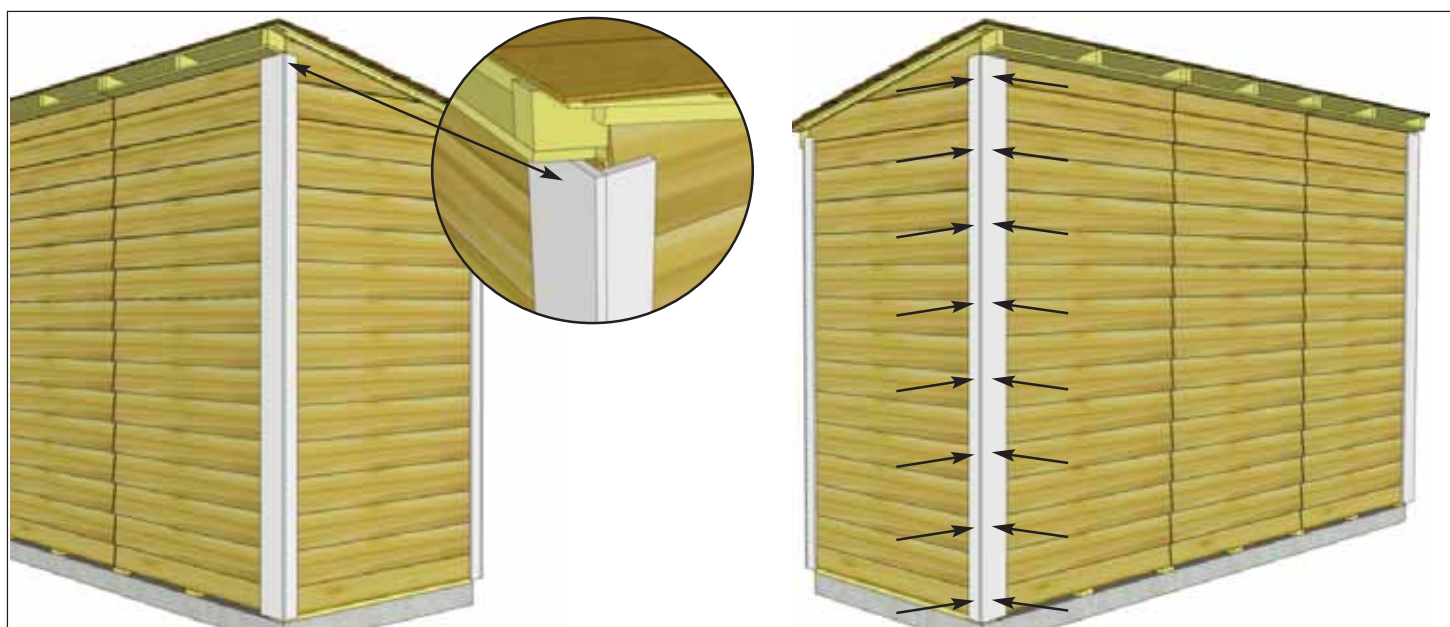

53. To complete trimming out rear corners, locate **4O & 4P - Rear Corner Trims**. Align and attach as per **Step 52**.

Parts

4O - Rear Corner Trims
(1/2" x 5 1/2" x 88 3/4") x 2
4P - Side Rear Corner Trims
(1/2" x 2 1/2" x 88 3/4") x 2

Hardware

N1 - 1 1/2" Finishing Nails
x 32 total

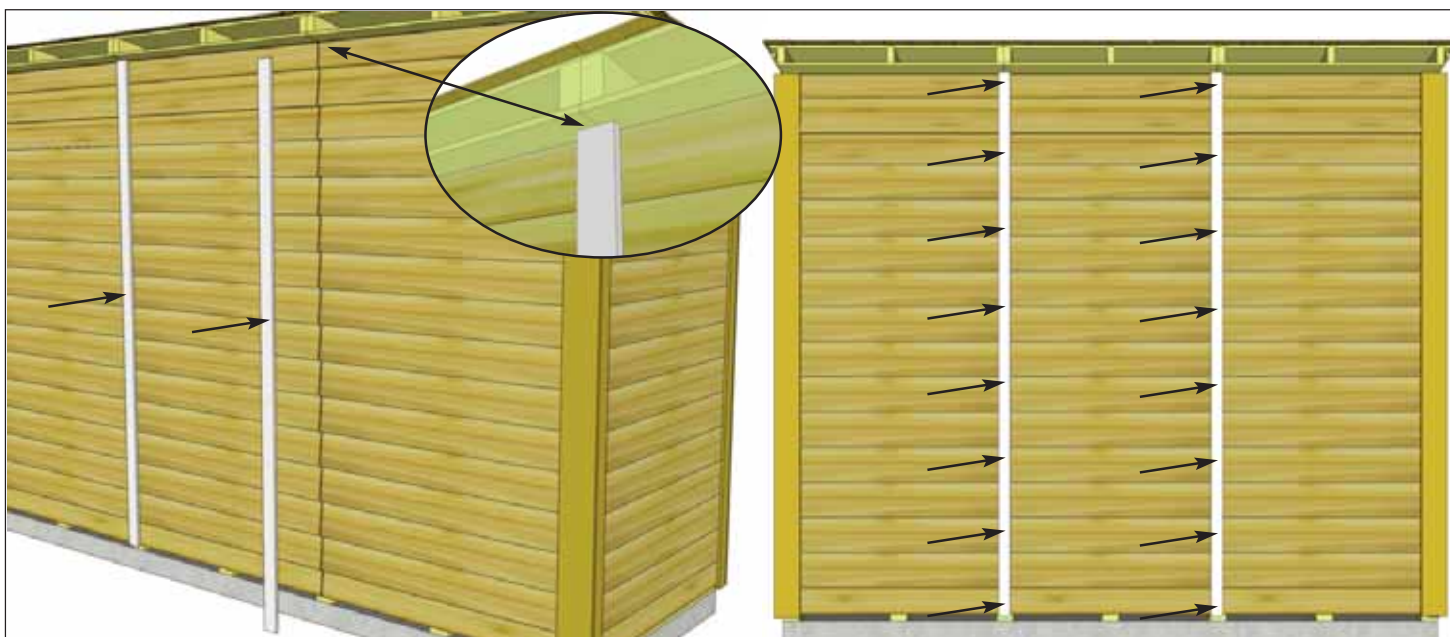

54. Attach **4P - Rear Middle Trims** where wall panels come together at rear seam. Attach with **8 - 1 1/2" Finishing Nails** aligning tight underneath soffit and center on seam.

Parts
4P - Rear Middle Trim
 (1/2" x 2 1/2" x 88 3/4") x 2

Hardware
N1 - 1 1/2" Finishing Nails
 x 16 total

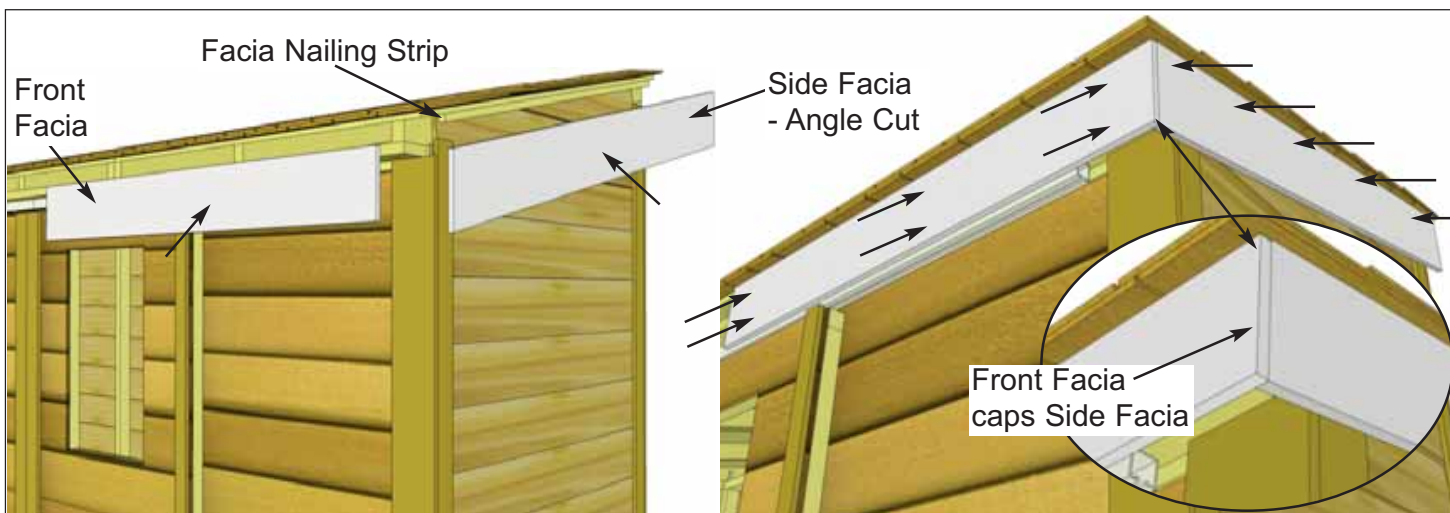

55. Locate one **4Q - Side Facia** and one **4R - Front Facia** and align in front corner. Position facias underneath roof panel, doing a dry run first before securing. Front Facia goes against rafter ends and Side Facia goes against Facia Nailing Strip. Align so the Front Facia caps the Side Facia. Attach Front Facia with **2 - 1 1/2" Finishing Nails** per rafter end. Attach Side Facia to the Facia Nailing Strip with **5 - 1 1/2" Finishing Nails**.

Parts (Steps 55 - 58)
4Q - Side Facia - Angle Cut Ends
 (1/2" x 5 1/2" x 54 1/8") x 2
4R - Front & Rear Facia - L/R
 (1/2" x 5 1/2" x 50 1/2") x 4
4S - Front & Rear Facia - Center
 (1/2" x 5 1/2" x 45 1/2") x 2

Hardware (Steps 55 - 58)
N1 - 1 1/2" Finishing Nails x 46 total



56. Attach other Front and Side Facia to opposite corner as per **Step 55**.

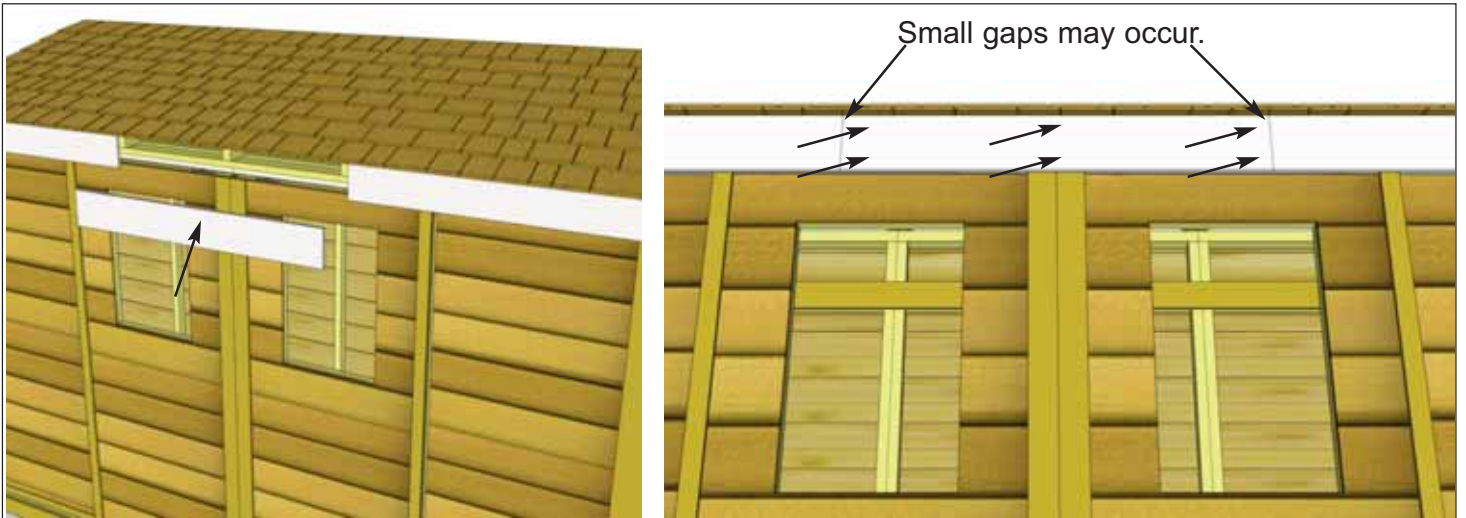

57. Attach **4S - Front Facia - Center** to rafter ends as shown above. Small gaps may occur between the Center and Left/Right Facia, but these will be covered by Facia Detail Plates in **Step 59**. Attach with **2 - 1 1/2" Finishing Nails** per rafter end.

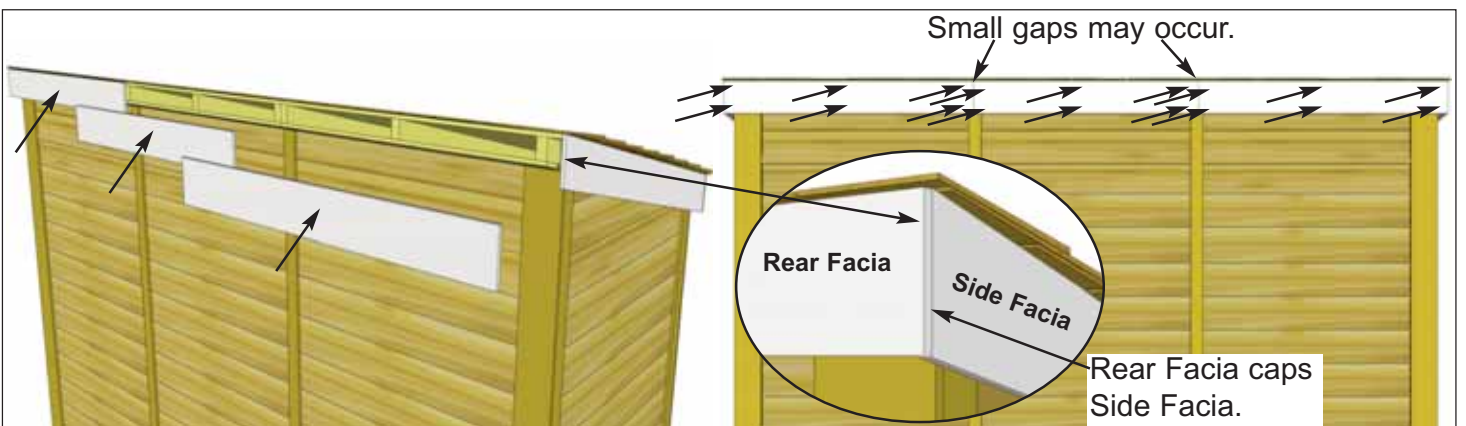

58. Attach **4R & 4S - Rear Facia** onto rafter ends as per **Steps 55 - 57**. Small gaps may occur between the Center and Left/Right Facia, these will be covered by Facia Detail Plates in **Step 59**. Rear Facia will cap the side Facia. Attach Rear Facia to rafter ends with **2 - 1 1/2" Finishing Nails** per rafter end.

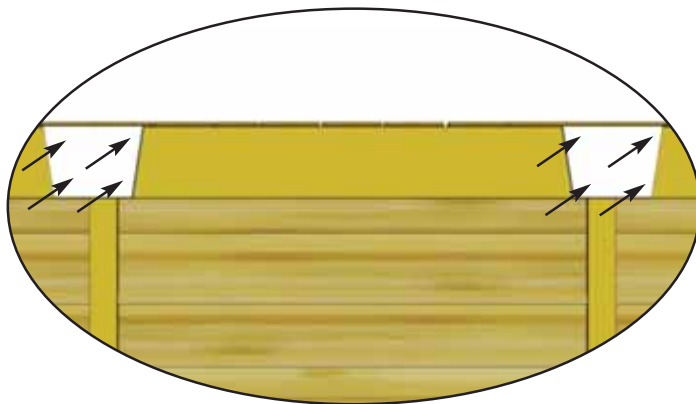
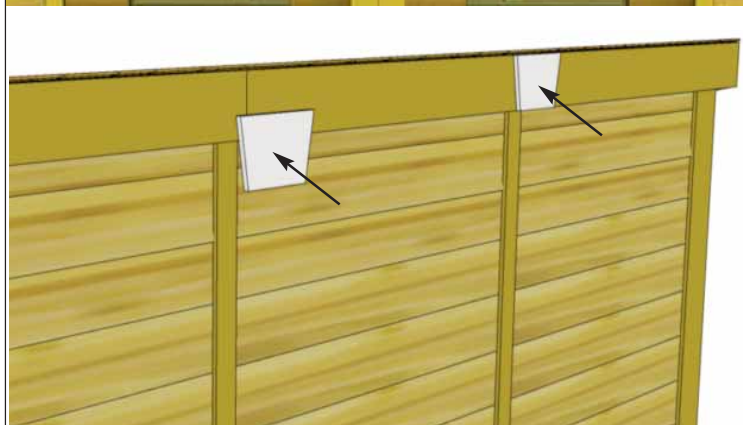
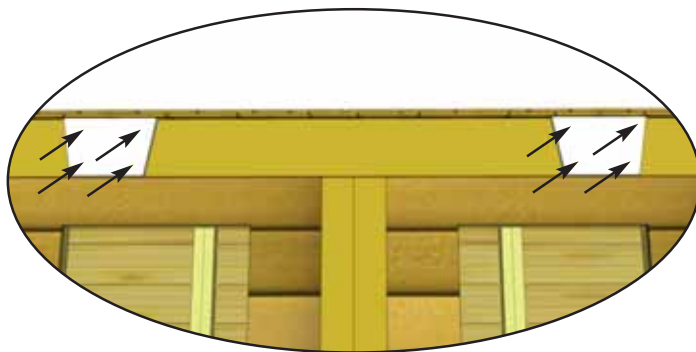
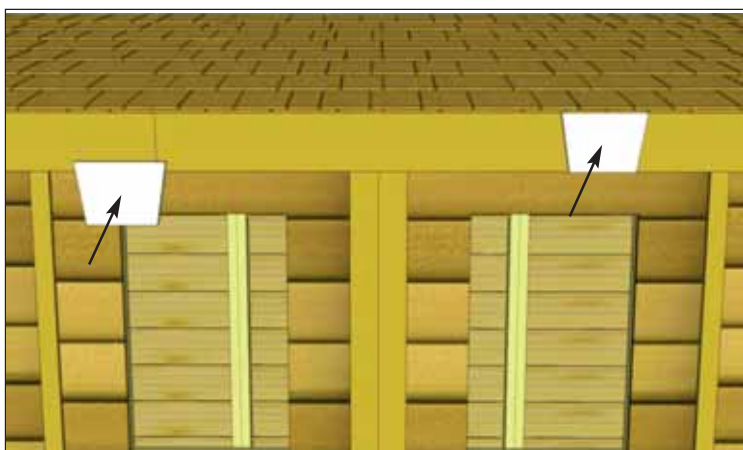

59. Attach **4T - Facia Detail Plates** to cover seams where Front and Rear Facia pieces meet. Secure with **4 - 1 1/2" Finishing Nails** per piece.

Parts
4T - Facia Detail Plates
(5 1/2" high) x 4

Hardware
N1 - 1 1/2" Finishing Nails
x 16 total

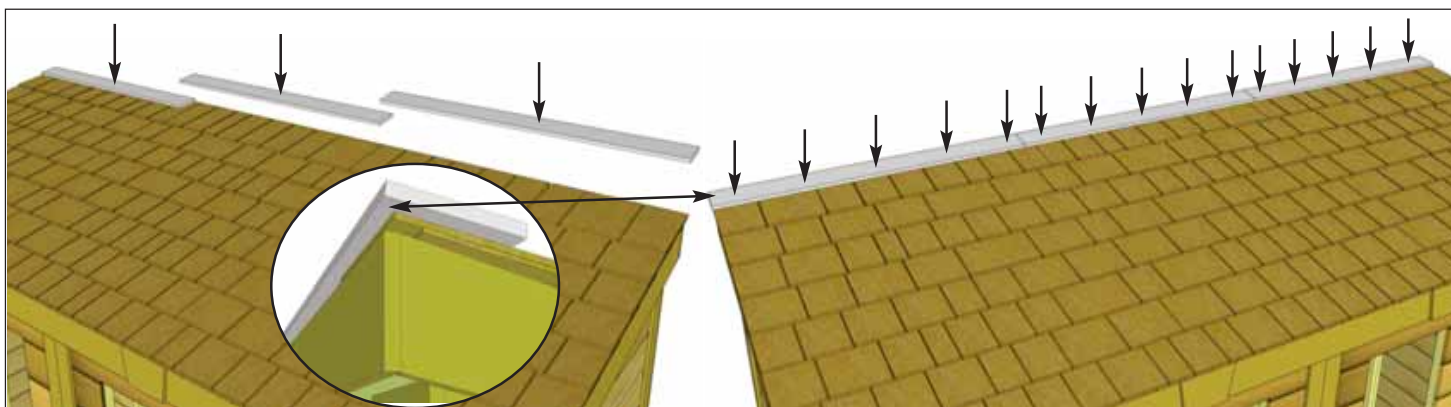

60. Position **4U - Roof Ridge Board** at the rear of roof to cap off shingles and facia. Ridge Boards should meet on seam of roof panels. When aligned correctly, attach with **5 - 1 1/2" Finishing Nails** per piece.

Parts
4U - Roof Ridge Boards
(1/2" x 4 1/2" x 49 1/4") x 3

Hardware
N1 - 1 1/2" Finishing Nails
x 15 total

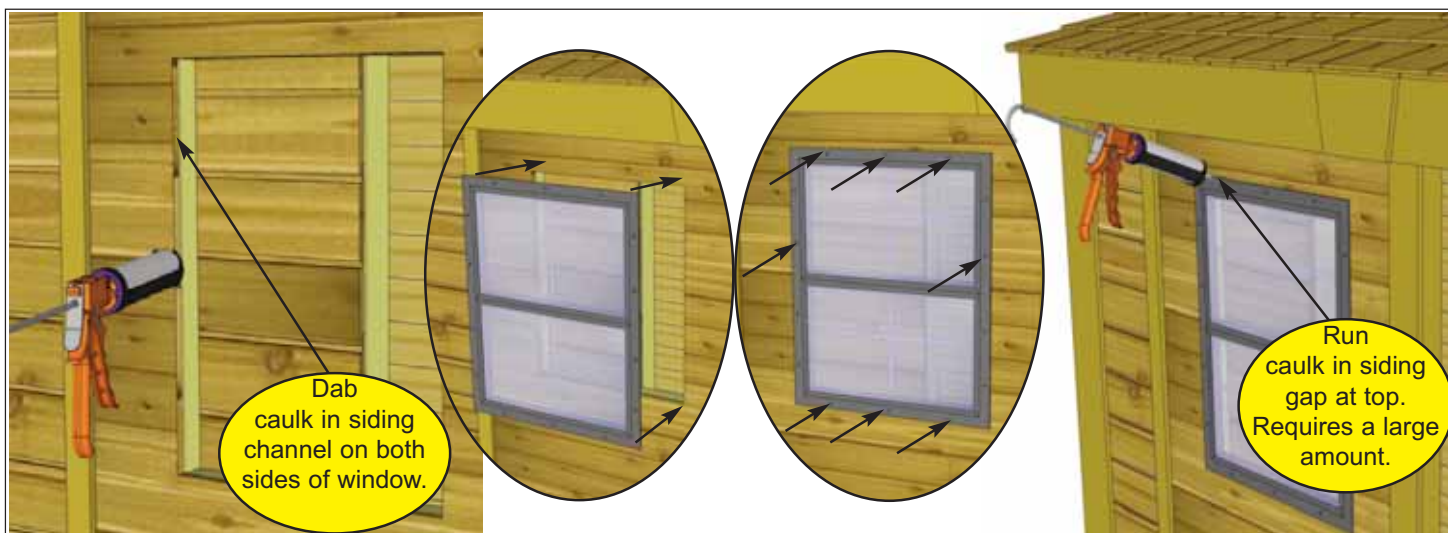

61. Locate **4V - Window Inserts**. Before installing, dab caulk in siding channel on both sides of window opening. This will prevent water from getting in behind window. Position window in cavity and secure with **8 - 1 1/4" Screws**. Caulk gap between siding and window at top. This requires a large amount of caulking but is important to fill. Later, Window Trims will be installed to hide caulking. Complete second Window Insert the same.

Parts
4V - Window Inserts
 (18 1/4" x 23") x 2

Hardware
S2 - 1 1/4" Screws
 x 16 total

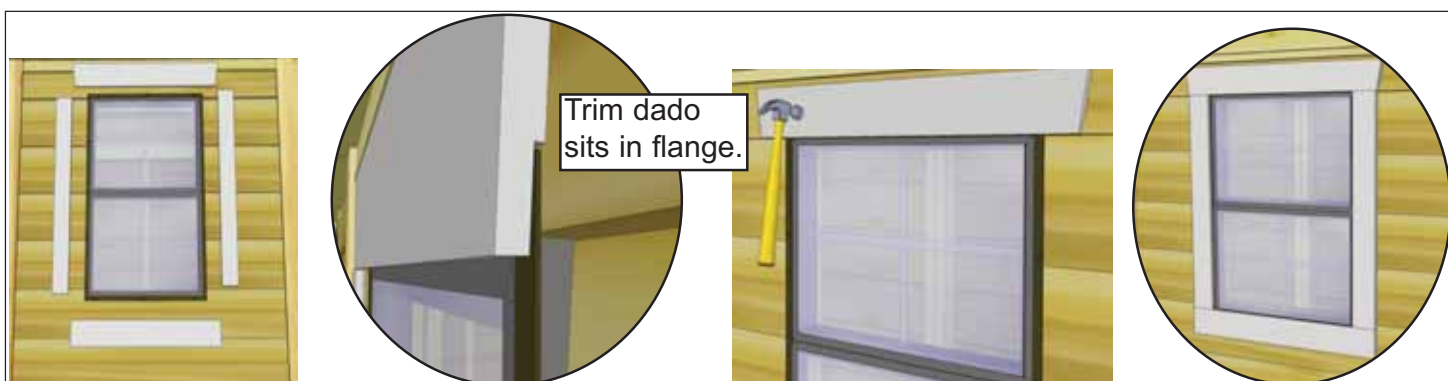

62. Position **4W - Window Trim** around window doing a dry run first and attach with **4 - 1 1/2" Finishing Nails** per piece. Window trim has a small dado on reverse face. Outside flange of window will roughly sit in the dado to give a better fit. Complete both windows the same.

Parts
4W - Window Trim Kit x 2
 (Top pc - 24 1/16") x **1- Angle Ends**
 (Side/Bottom pcs - 23") x 3

Hardware
N1 - 1 1/2" Finishing Nails x 32 total

63. Attach **Y3 - Door Handles** and **Y11 - Black Hasp**. Handles and Hasp are positioned on wide door trim and mounted with **3/4" Black Screws**.

Hardware
Y3 - Door Handles x 2 total
Y11 - Black Hasp x 1 total
SB1 - 3/4" Screws x 16 total

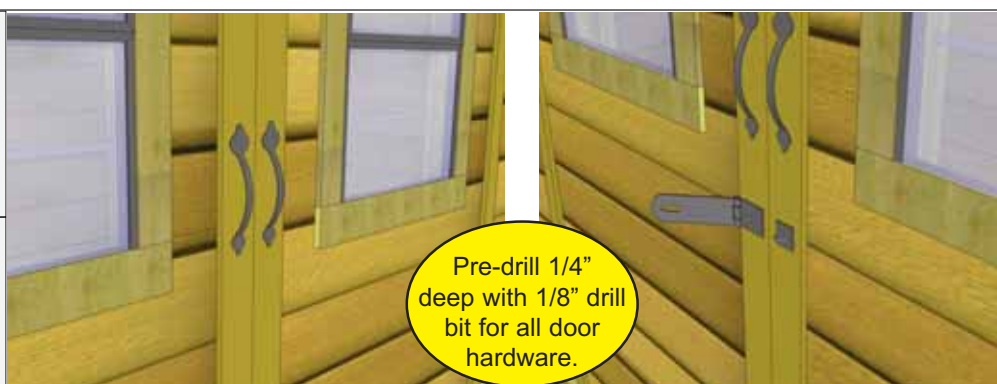



Congratulations on assembling your 12x4 SpaceSaver Shed with Sliding Doors!

Note: Our Sheds are shipped as unfinished products. If exposed to the elements, the western red cedar lumber will weather to a silvery-gray color. If you prefer to keep the cedar lumber looking closer to the original color, we suggest that you treat the wood with a good oil base wood stain. You may also wish to paint your new shed rather than stain it. In both cases we recommend that you consult with a paint and stain dealer in your area for their recommendations.

We hope your experience assembling your 12x4 Slider Lean-To Storage Shed has been both positive and rewarding.

We value your feedback and would like to hear back from you on how well we are doing in the following areas:

1. Customer Service
2. On Time Shipping
3. Motor Freight Delivery
4. Quality of Materials
5. Assembly Manual
6. Overall Satisfaction.



The materials contained in this Assembly Manual may be downloaded or copied provided that ALL copies retain the copyright and any other proprietary notices contained on the materials. No material may be modified, edited or taken out of context such that its use creates a false or misleading statement or impression as to the positions, statements or actions.

Please call, write or email us at:

Outdoor Living Today

Canadian Address
9393 287th Street
Maple Ridge, British Columbia
Canada V2W 1L1

United States Address
P.O. Box 96
Sumas, Washington
USA 98295