

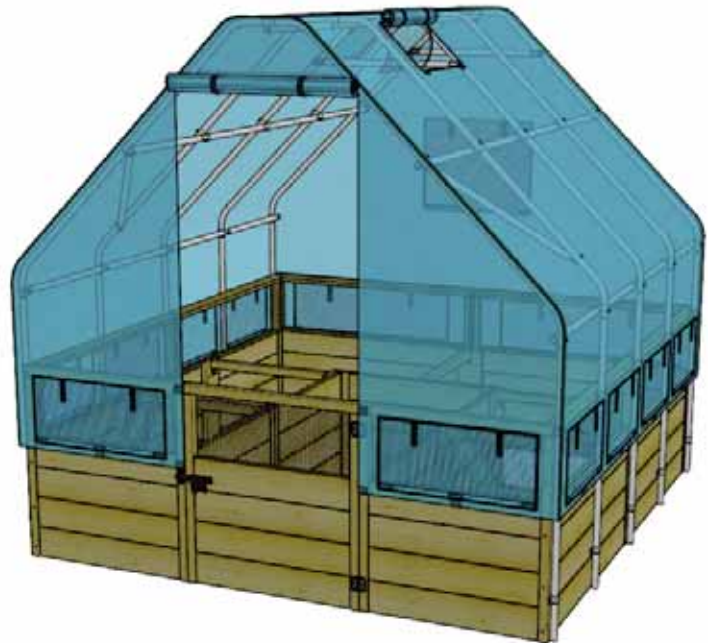

# 8x8 Garden in a Box with Greenhouse Cover Assembly Manual

Thank you for purchasing a  
8x8 Garden in a Box with Greenhouse  
Cover. Please take the time to identify  
all the parts prior to assembly.

Version #2.5  
Jan 26, 2022



In colder climates, please remove your Garden in a Box  
Plastic Cover during the winter months and store in  
included bag in a dry warm location.

Do not leave cover on during any large snow storms or  
extreme weather phenomenon such as hurricanes,  
tornadoes or heavy wind storms.

Cover can easily be taken off in minutes if such weather  
patterns are forecast in your area.

We recommend once a year in the early spring to check  
that all fasteners are snug and to tighten if loose.

Plastic cover can be cleaned with a mild soap and a cloth.











**Customer agrees to hold Outdoor Living Today  
and any Authorized Dealers free of any liability  
for improper installation, maintenance and  
repair.**

In the event of a missing or broken piece, call the Outdoor Living Today Customer Support Line @ 1-888-658-1658 within 30 days of the delivery of your purchase. It is our commitment to you to courier replacement parts, free of charge, within 10 business days of this notification. Replacement parts will not be provided free of charge after the 30 day grace period.

All structures purchased from Outdoor Living Today are covered for a period of one year for defects in manufacturing and workmanship. Costs incurred for customer installations are not included.

Failure to use supplied parts included in this kit could result in poor product performance and may void your warranty. Please contact Outdoor Living Today's Customer Toll Free Line if you plan to deviate from our written instructions.

Thank you for purchasing our 8x8 Garden in a Box with Greenhouse Cover. Please take the time to identify all the parts prior to assembly.

<b>Part 1</b>		<b>x 10</b>
<b>Part 2</b>		<b>x 5</b>
<b>Part 3</b>		<b>x 10</b>
<b>Part 4</b>		<b>x 5</b>
<b>Part 5</b>		<b>x 5</b>
<b>Part 6</b>		<b>x 8</b>
<b>Part 7</b>		<b>x 2</b>
<b>Part 8</b>		<b>x 2</b>
<b>Part 9</b>		<b>x 3</b>
<b>Part 10</b>		<b>x 2</b>
<b>Part 11</b>		<b>x 3</b>

**Hardware & Miscellaneous**

2 x Protective Stripping Rolls (30ft each) 1 x BR1 - Square Drive Bit

44 x S2 - 1 1/4" Screws



2 x M6x60



23 x M6x55



8 x M6x35



20 x Pipe Clamps



12 x Washers

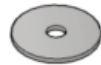

12 x 1 1/4" Pan Head Screws



Greenhouse Cover

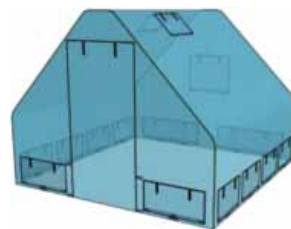
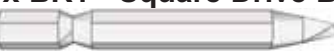

Storage Bag



12 x Clips

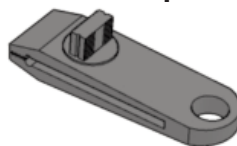

**Tools Required**

(Not Provided)



Screw Gun/Drill



Pliers



Phillips Screwdriver

# Exploded View

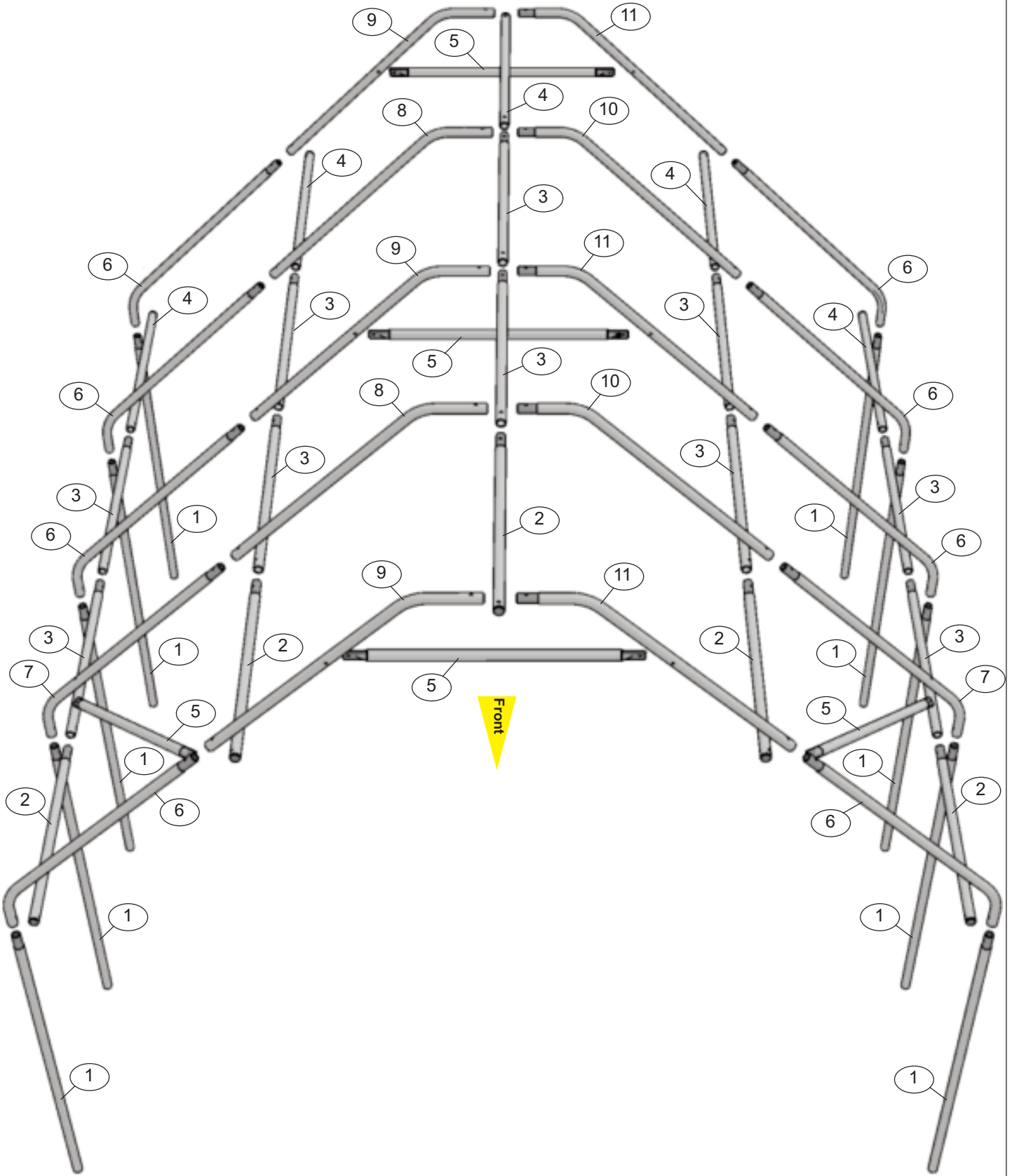

Step	Parts & Hardware	
	1	1 x Part 4
1 x Part 9		1 x M6x55

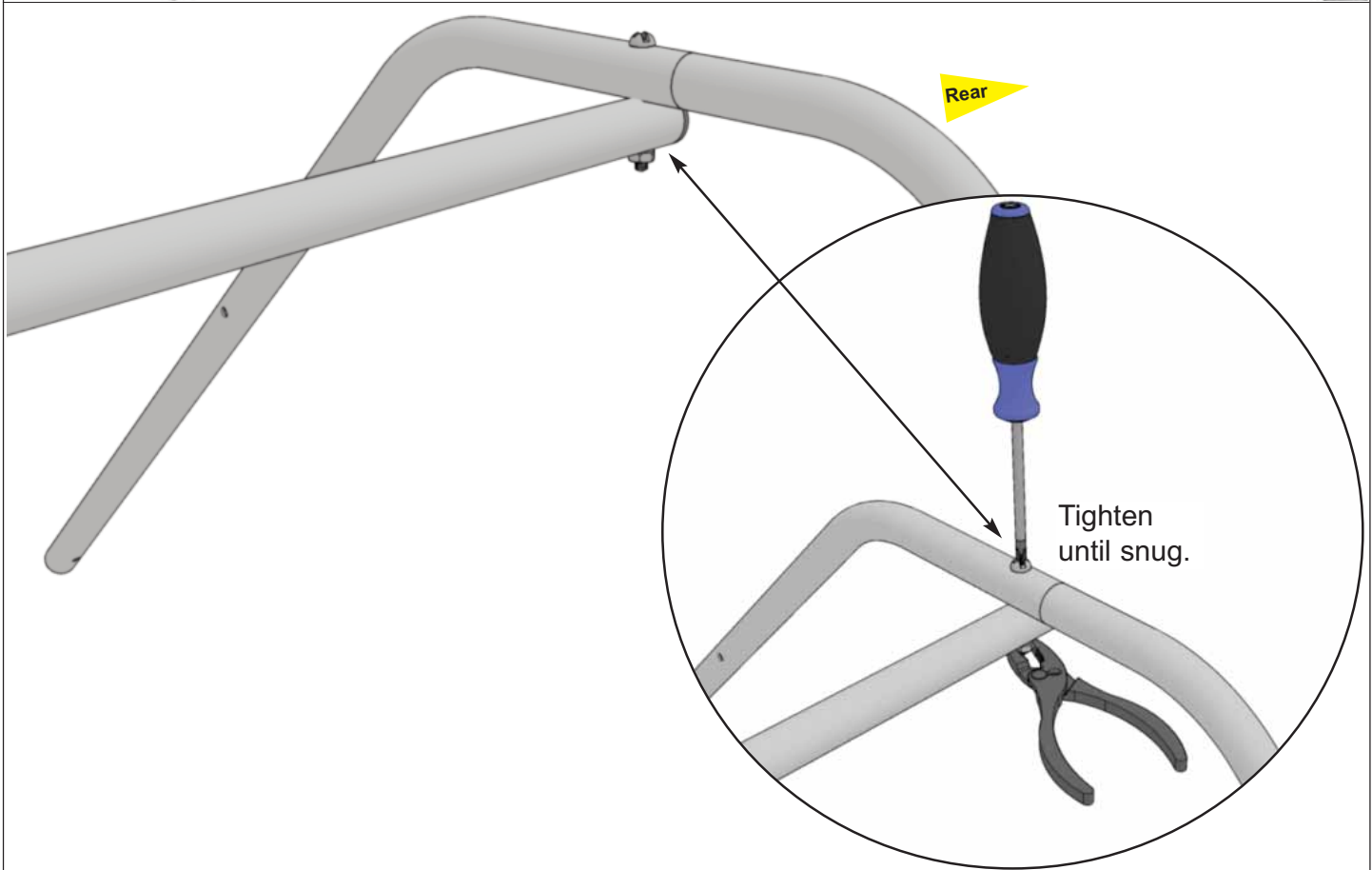
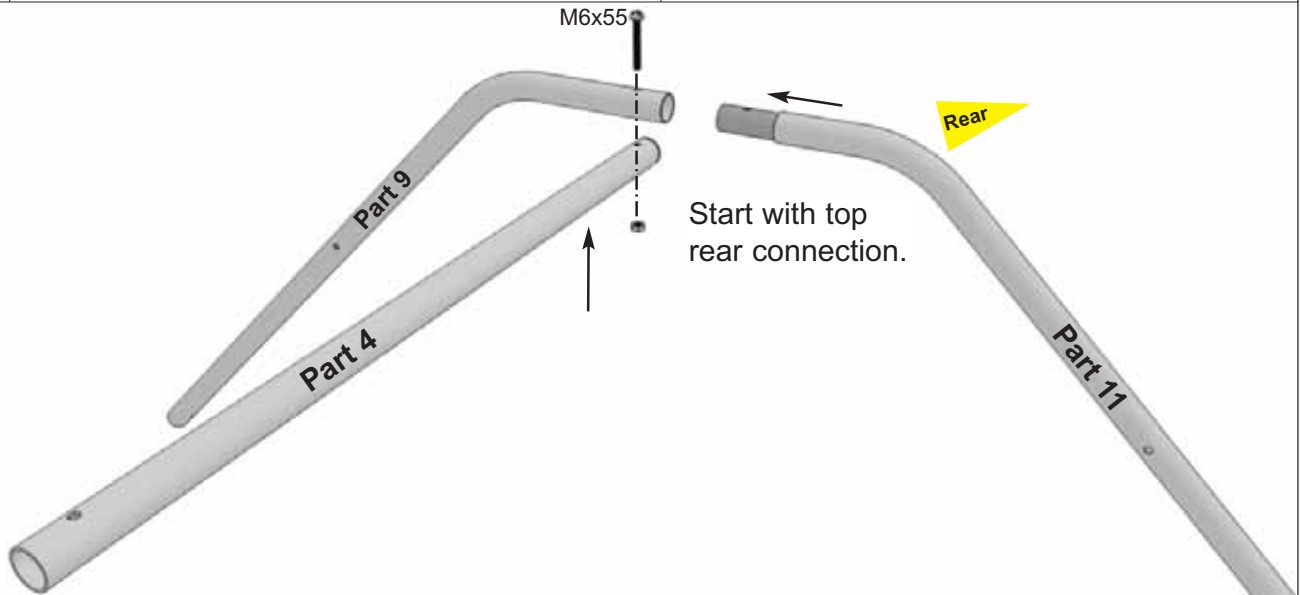

Step

2

Parts & Hardware

1 x Part 5



2 x M6x35

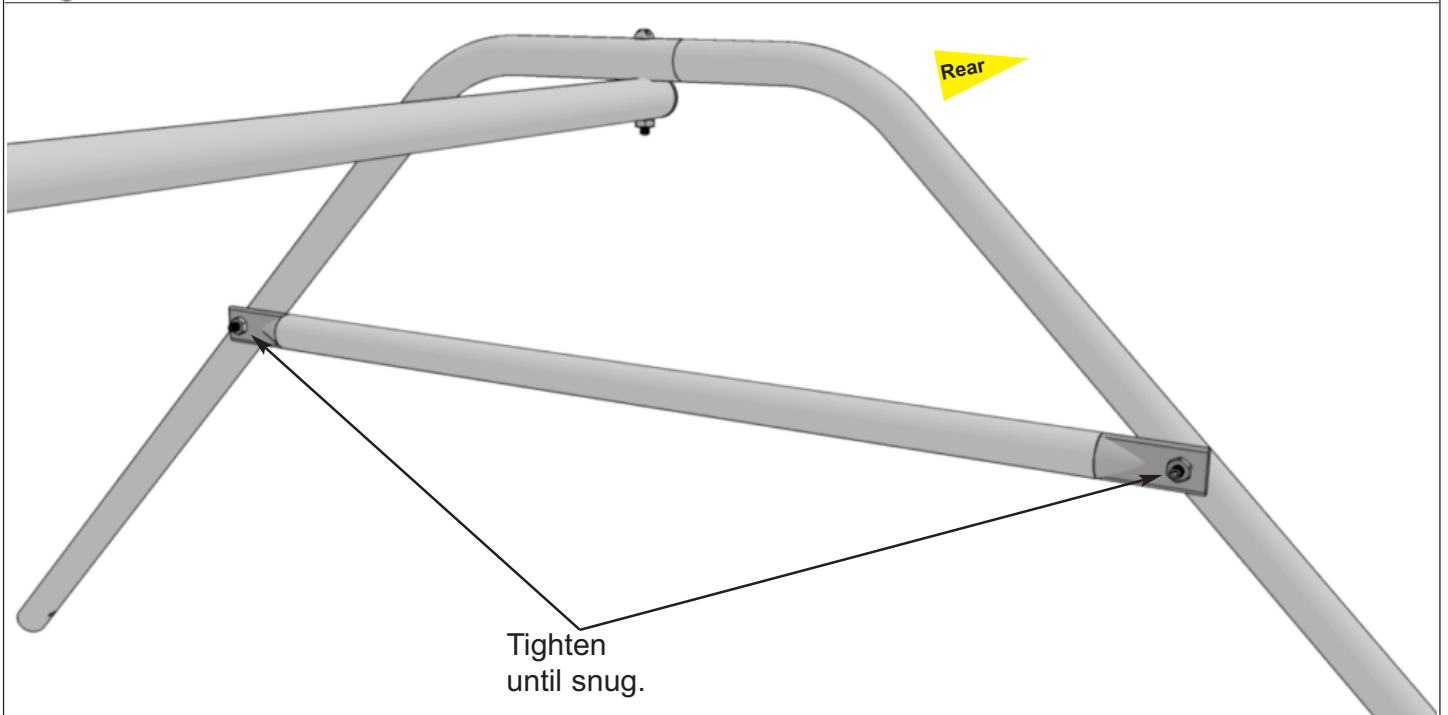
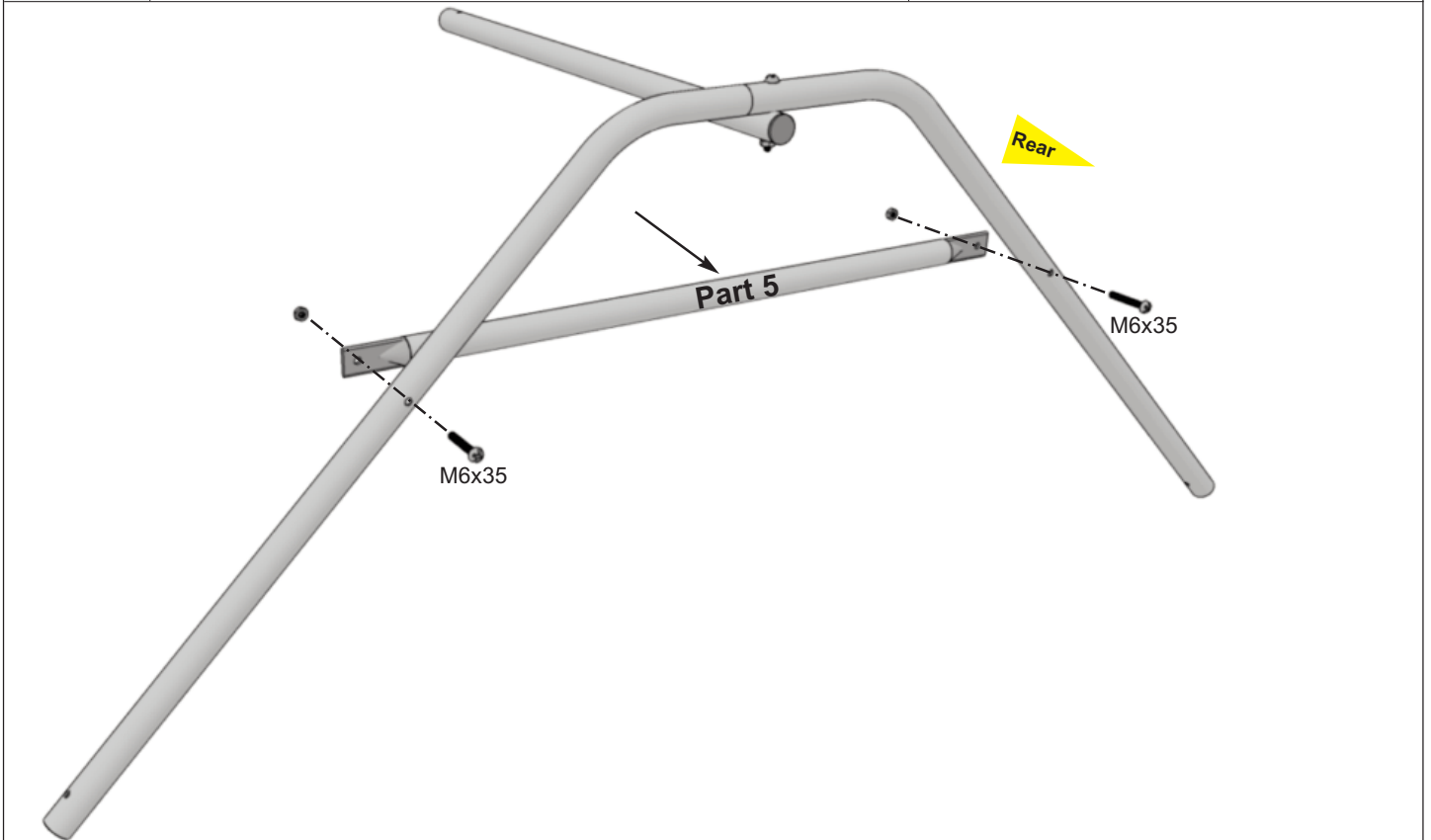

Step <b>3</b>	Parts & Hardware	
	1 x Part 3	1 x Part 10
	1 x Part 8	1 x M6x55

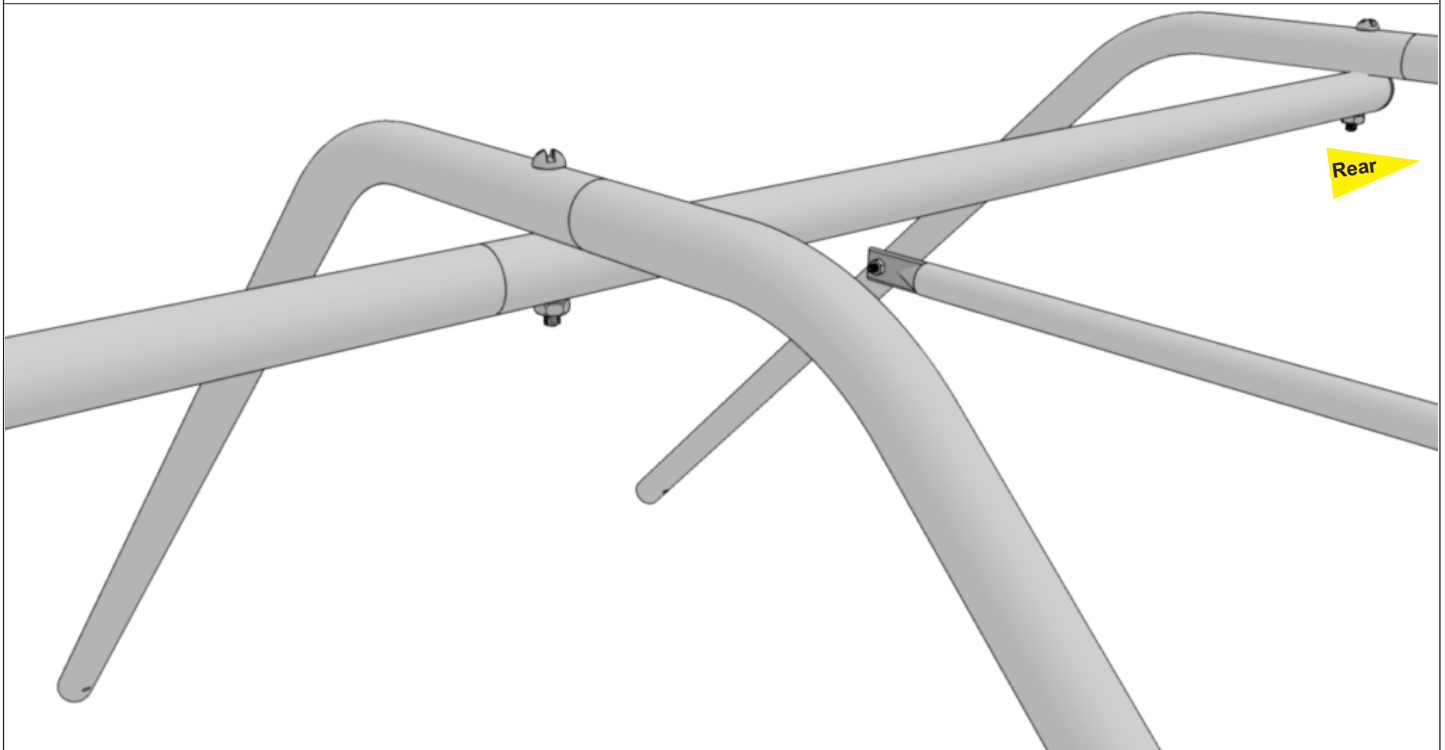
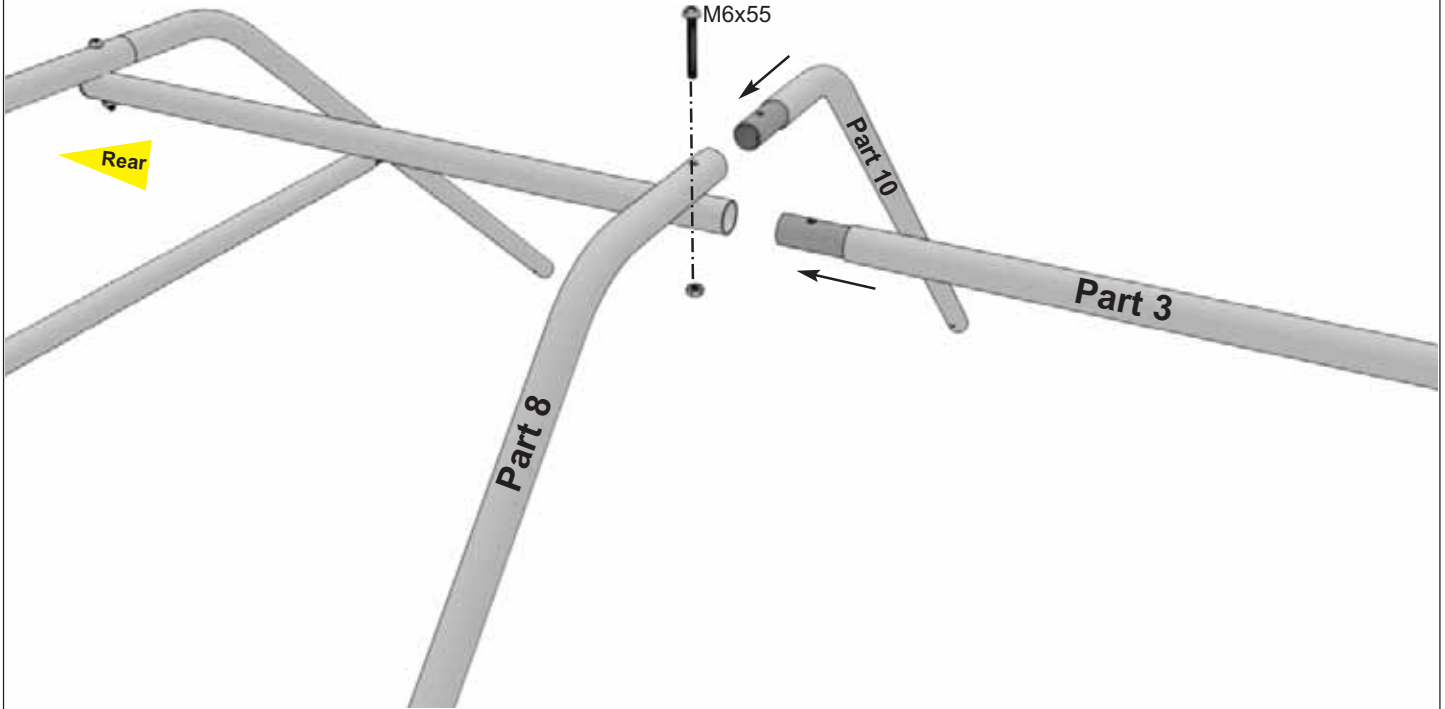

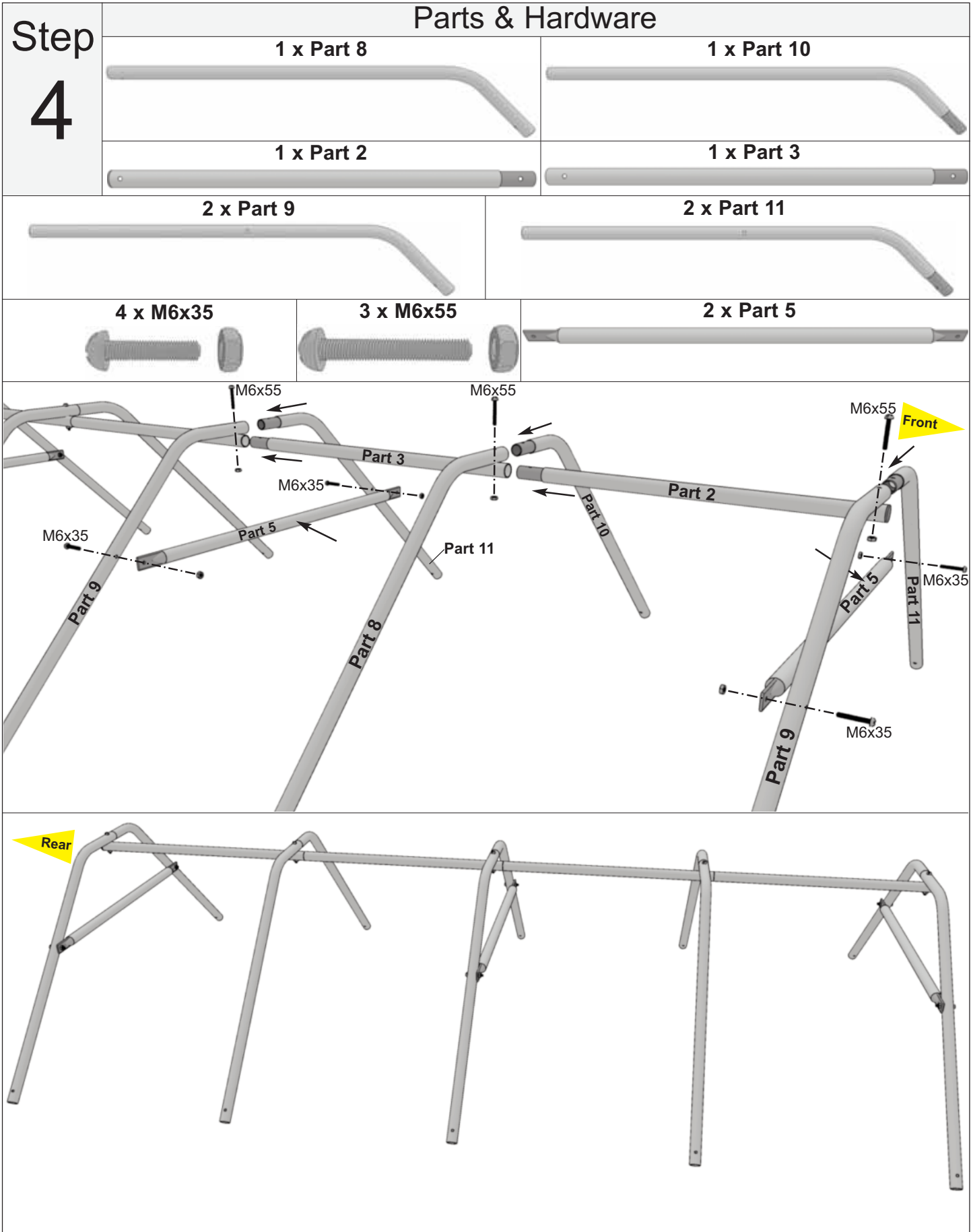

Step	Parts & Hardware	
	5	1 x Part 7
1 x Part 4		1 x Part 3
1 x Part 2		2 x Part 5
1 x M6x35		4 x M6x55

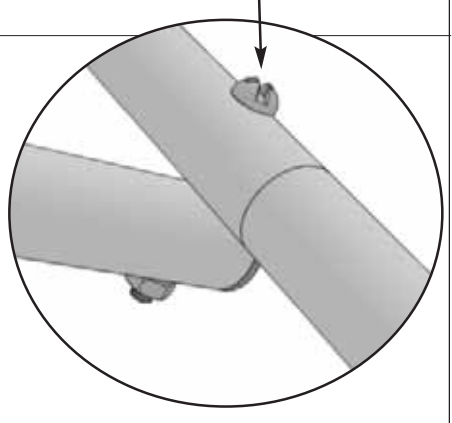
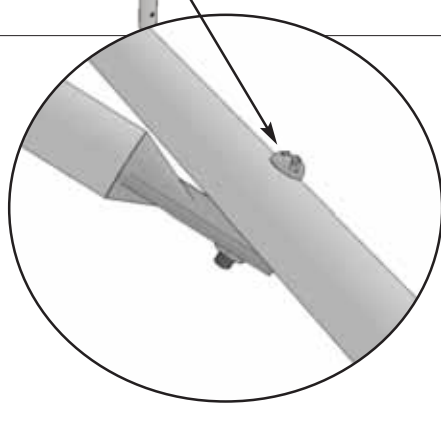
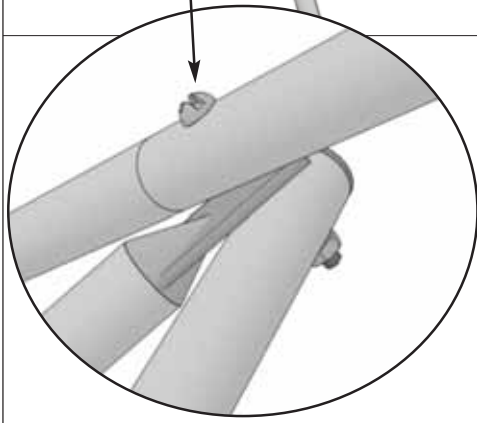
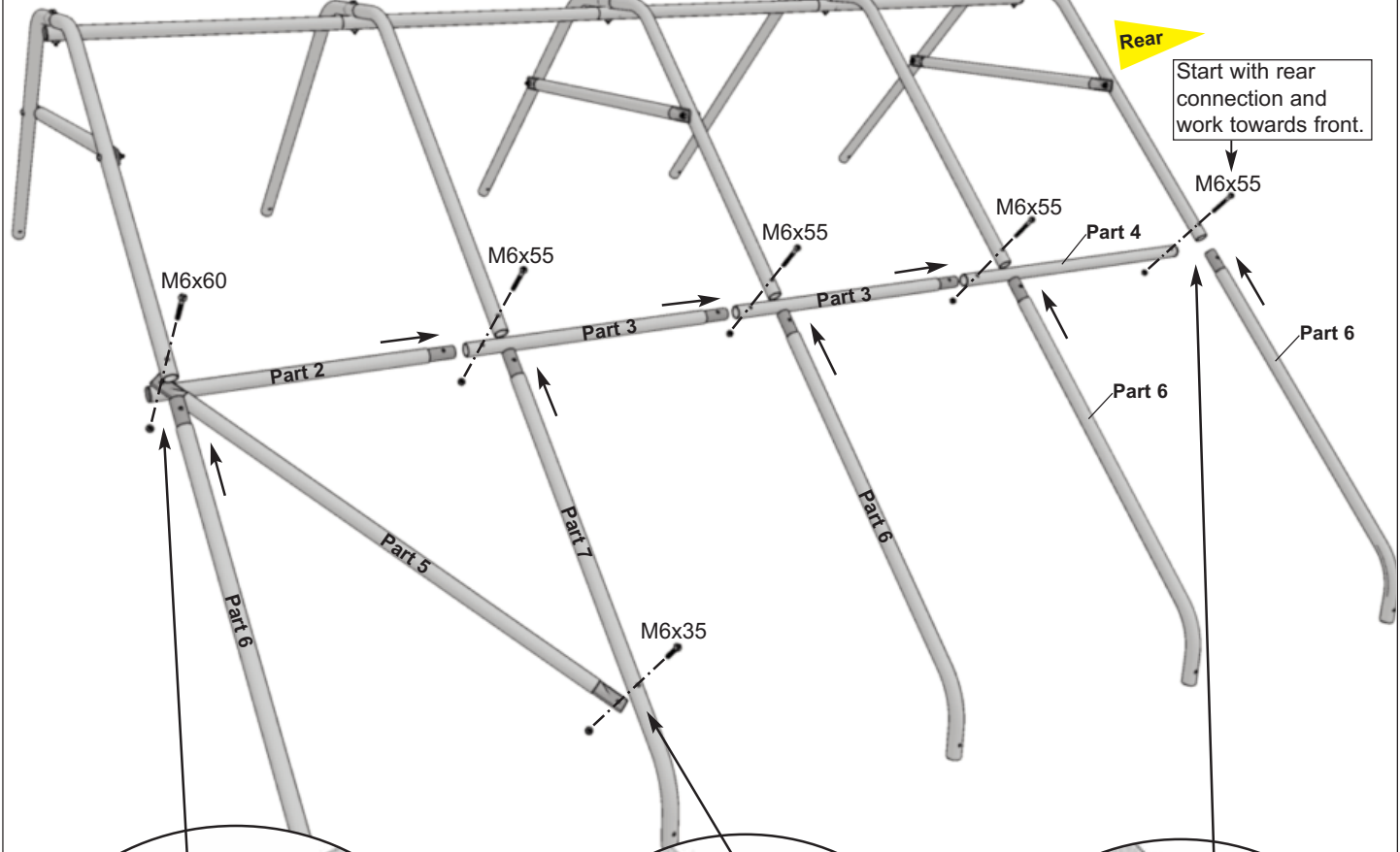



# Step 6

## Parts & Hardware

1 x Part 7

4 x Part 6

1 x Part 4

1 x Part 3

1 x Part 2

2 x Part 5

1 x M6x35

4 x M6x55

1 x M6x60

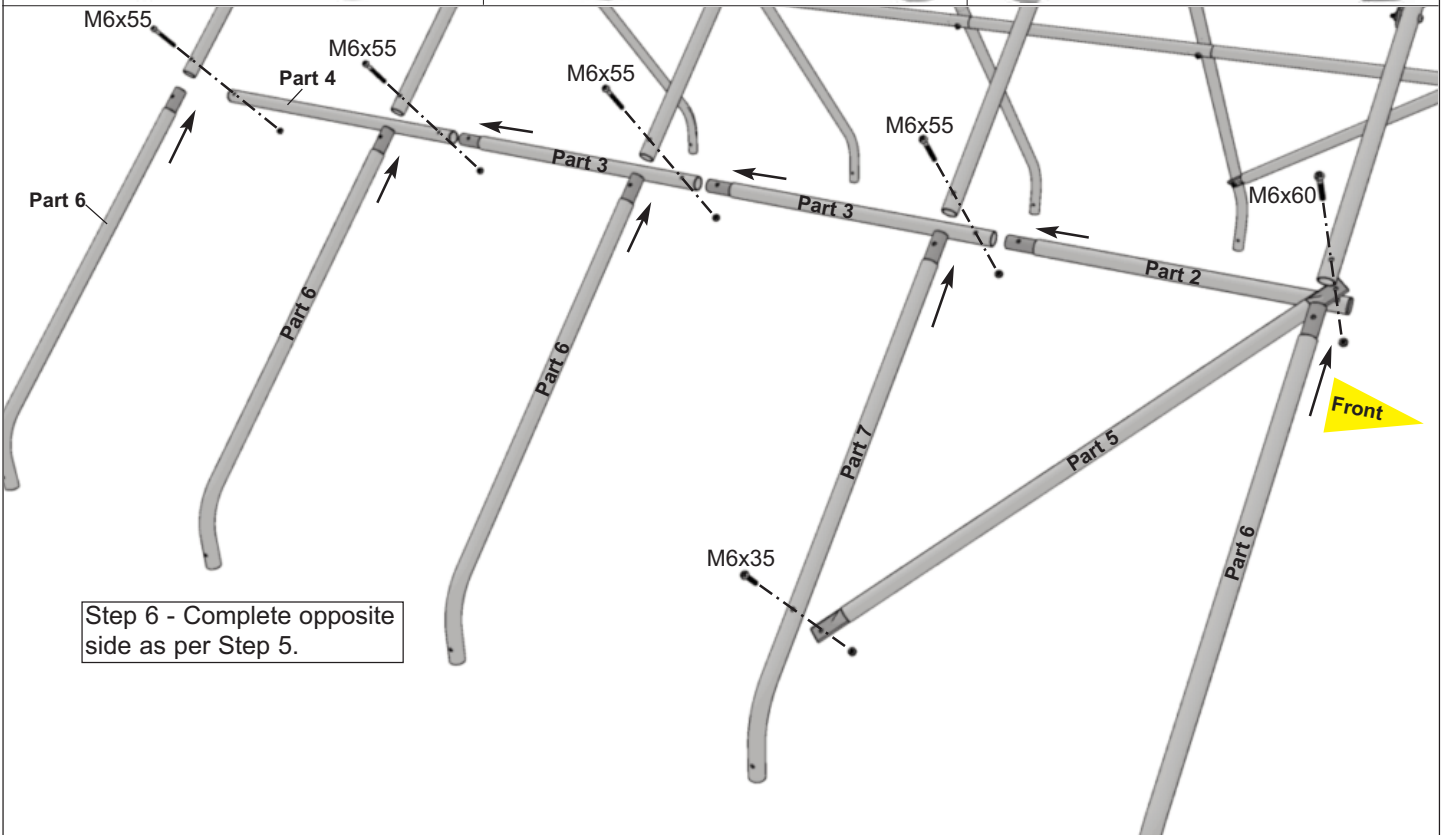

Step 6 - Complete opposite side as per Step 5.

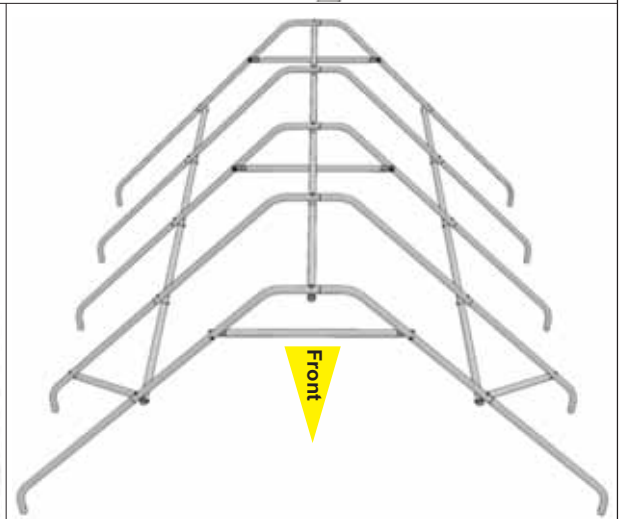
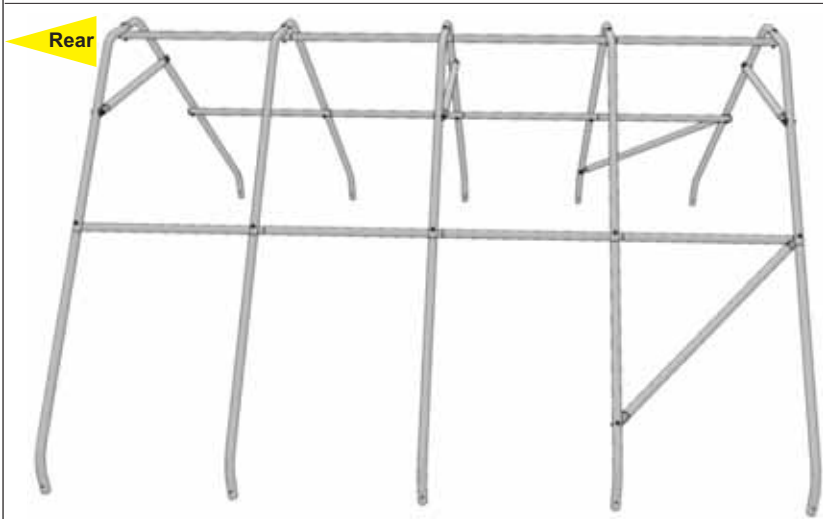

# Step 7

## Parts & Hardware

2 x Part 2

2 x Part 4

4 x Part 1

4 x M6x55

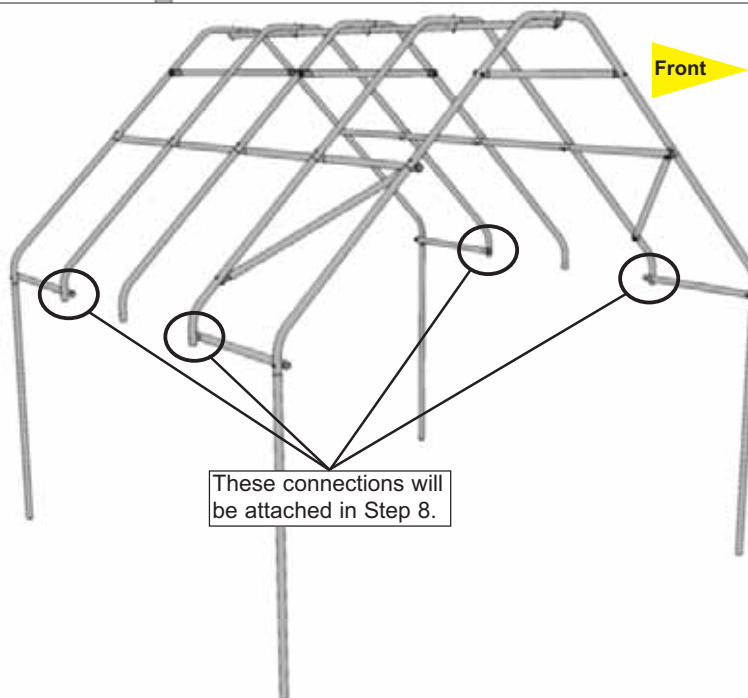
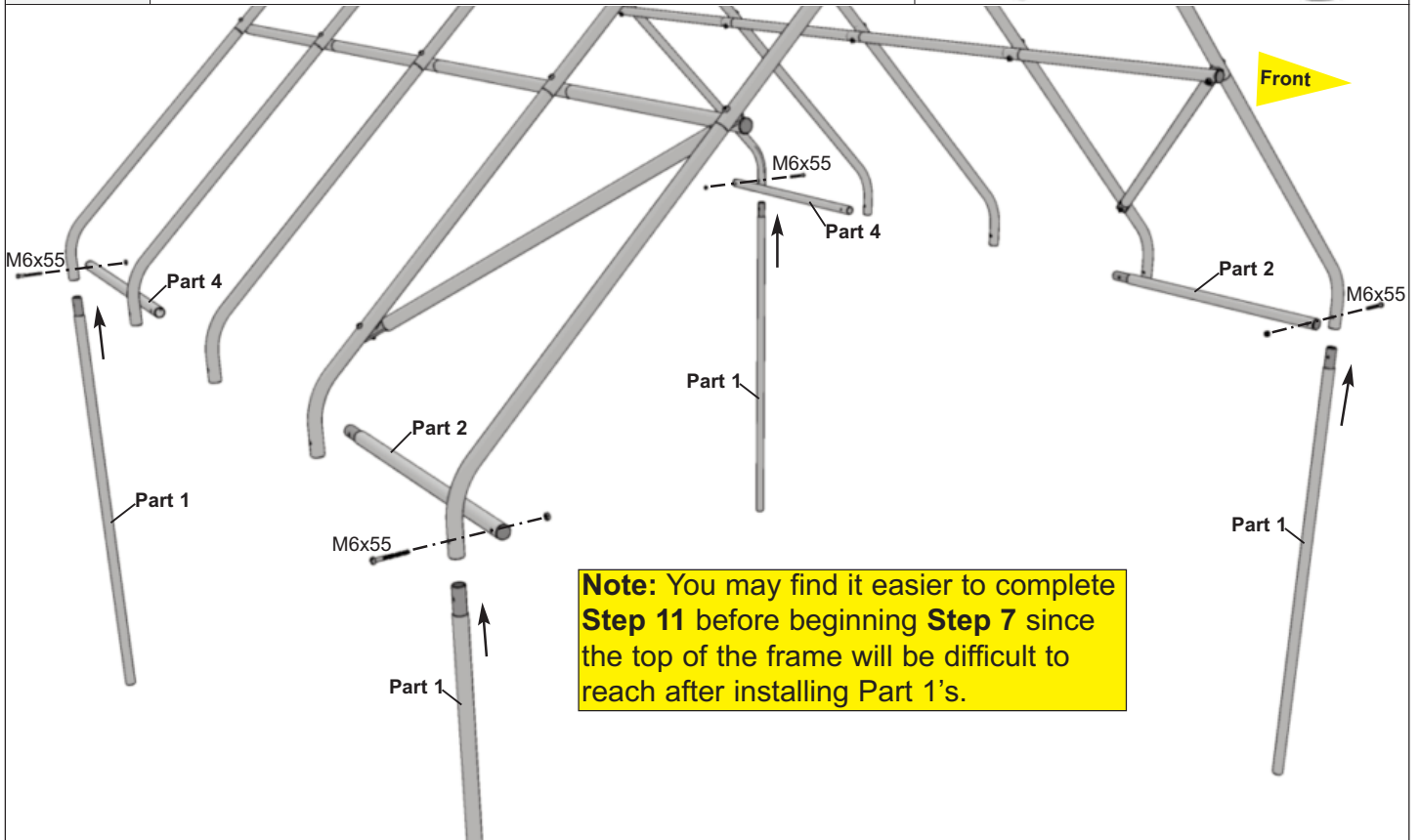

# Step 8

## Parts & Hardware

4 x Part 3



6 x M6x55



6 x Part 1

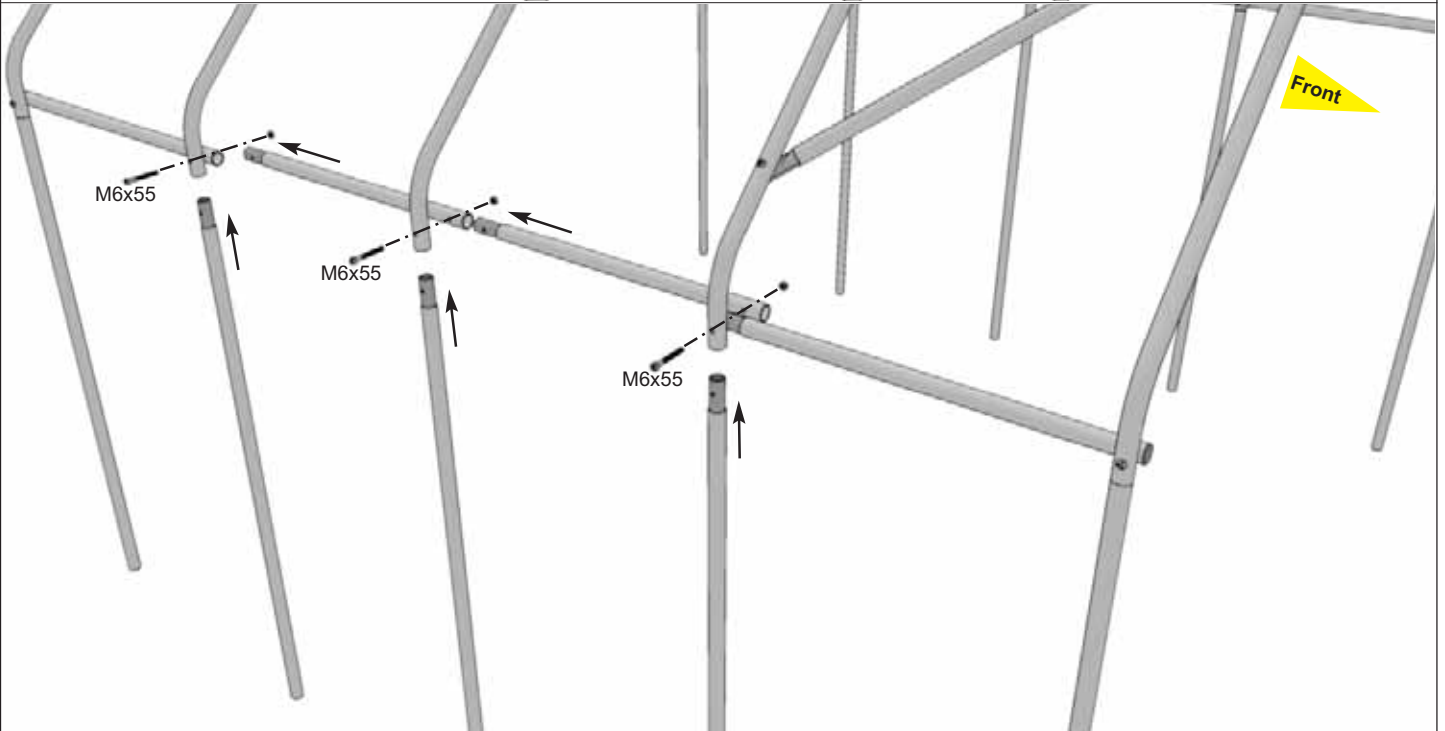
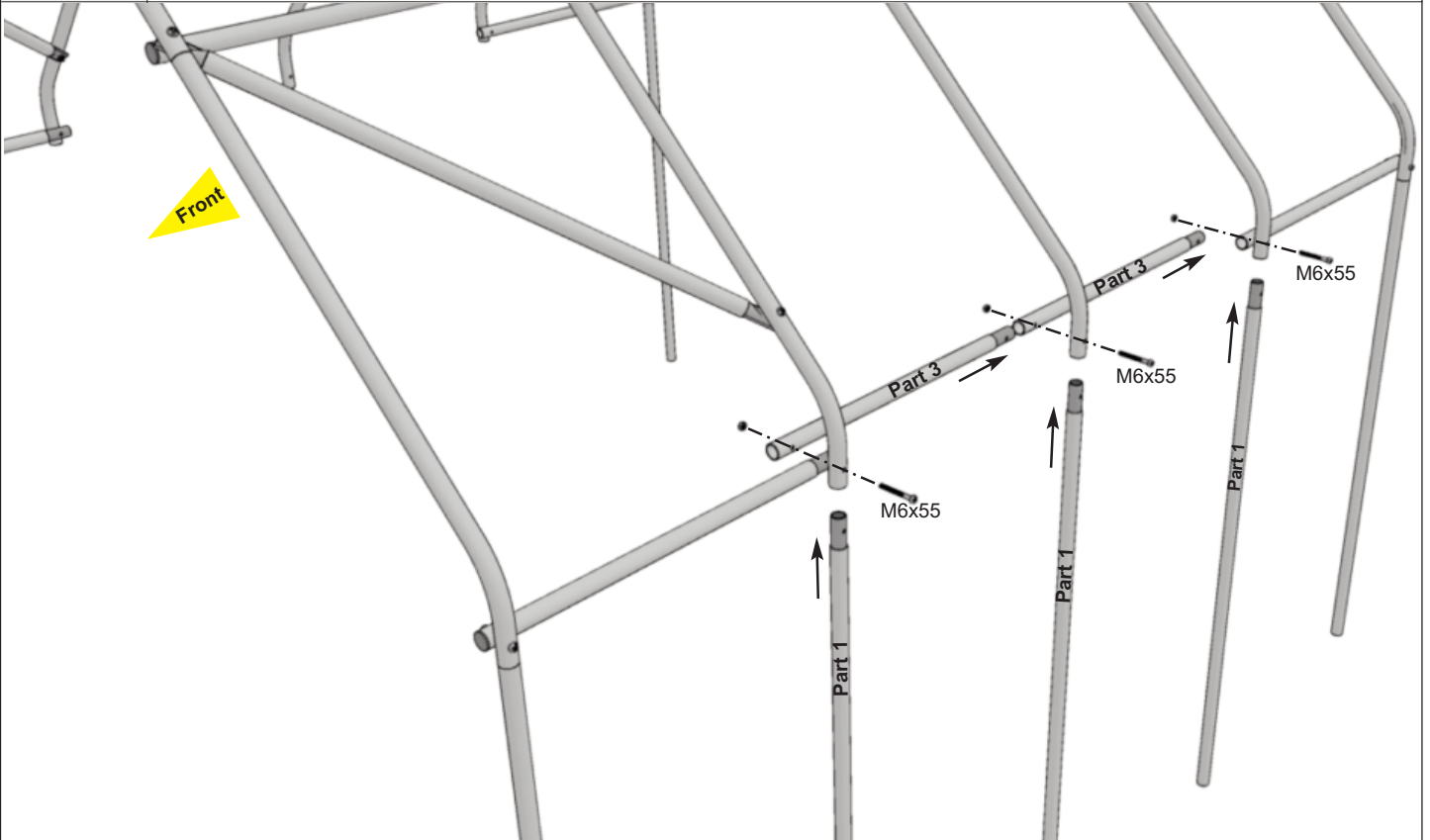

# Step 9

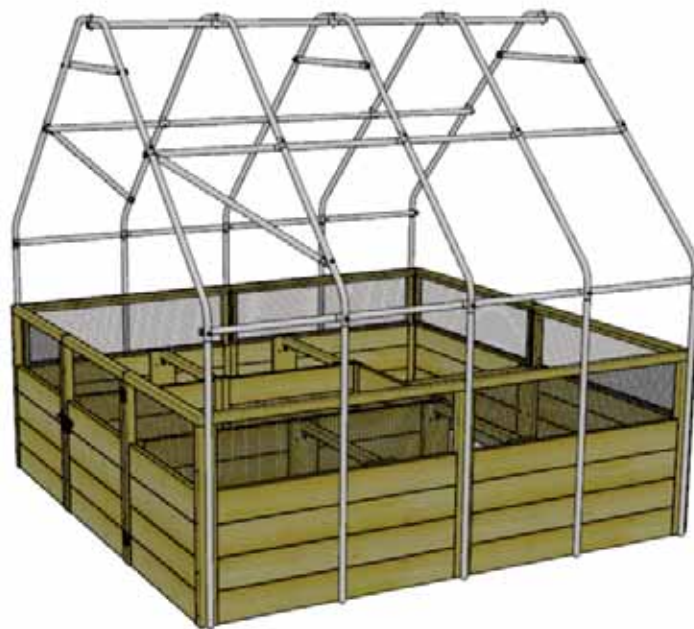
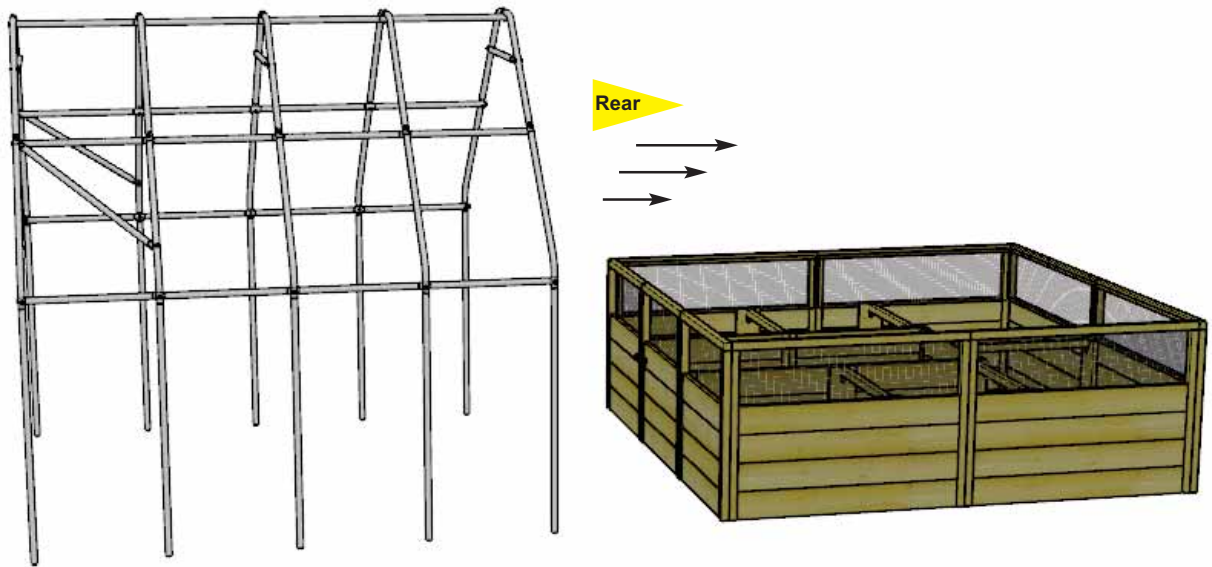

Step  
10

Parts & Hardware

20 x Pipe Clamps



40 x S2 - 1 1/4" Screws

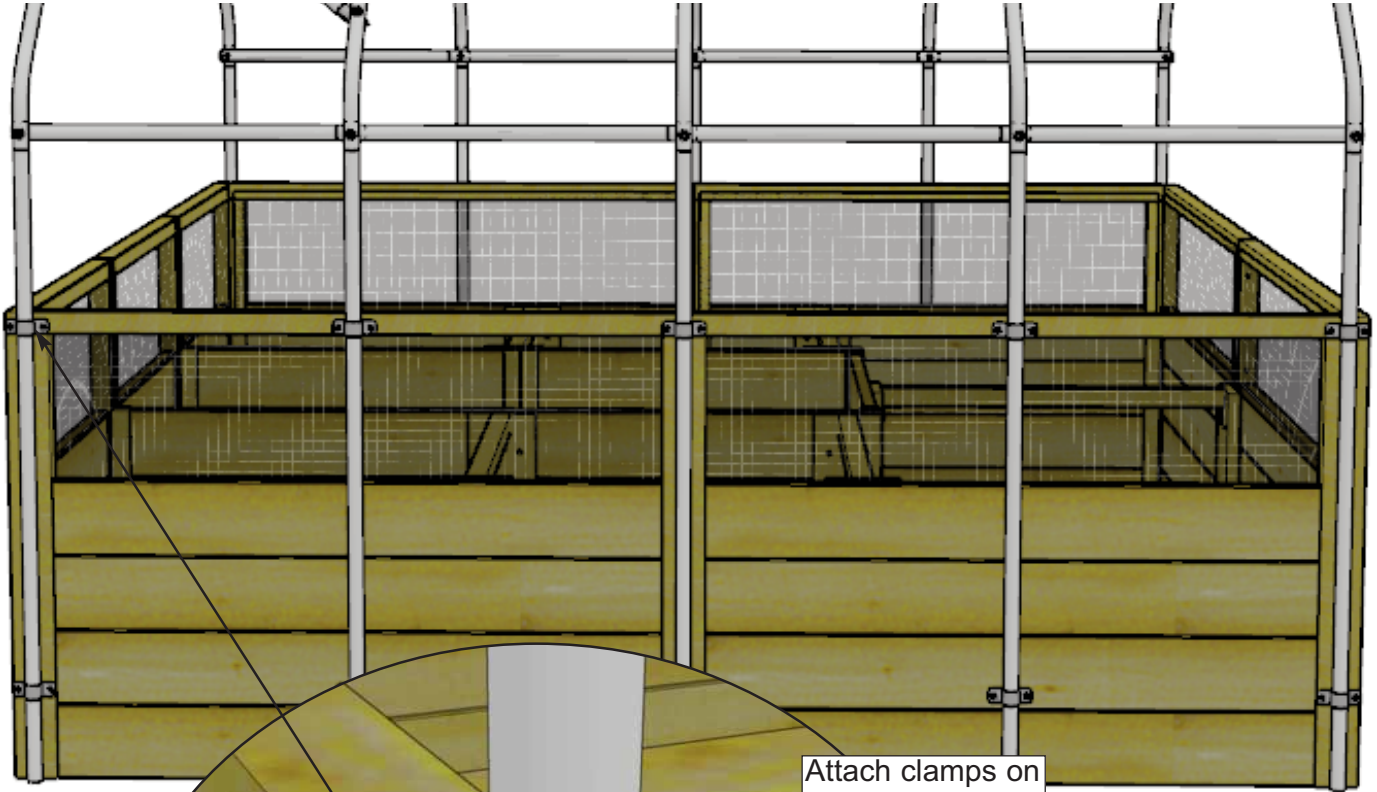

**Note:** Pre-drill pilot holes to prevent splitting.

Attach clamps on left and right side of garden bed.

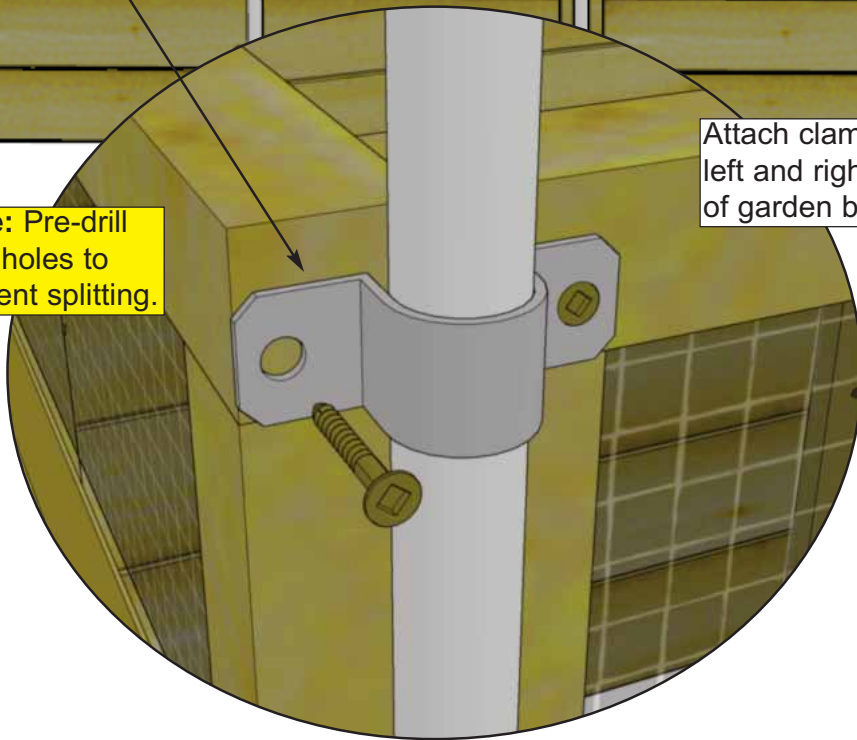

# Step

# 11

## Parts & Hardware



2x Protective Stripping Rolls

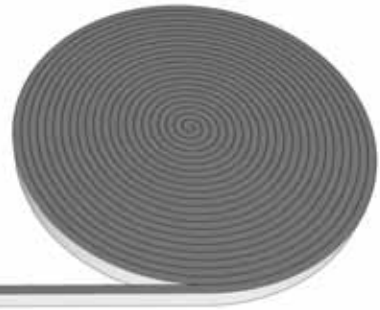

Peel off film to reveal adhesive side of protective stripping. Cover top of Greenhouse Frame with protective stripping as shown below. Start at the bottom of **Part 6** as shown. Protective stripping will prevent your frame from damaging the cover.

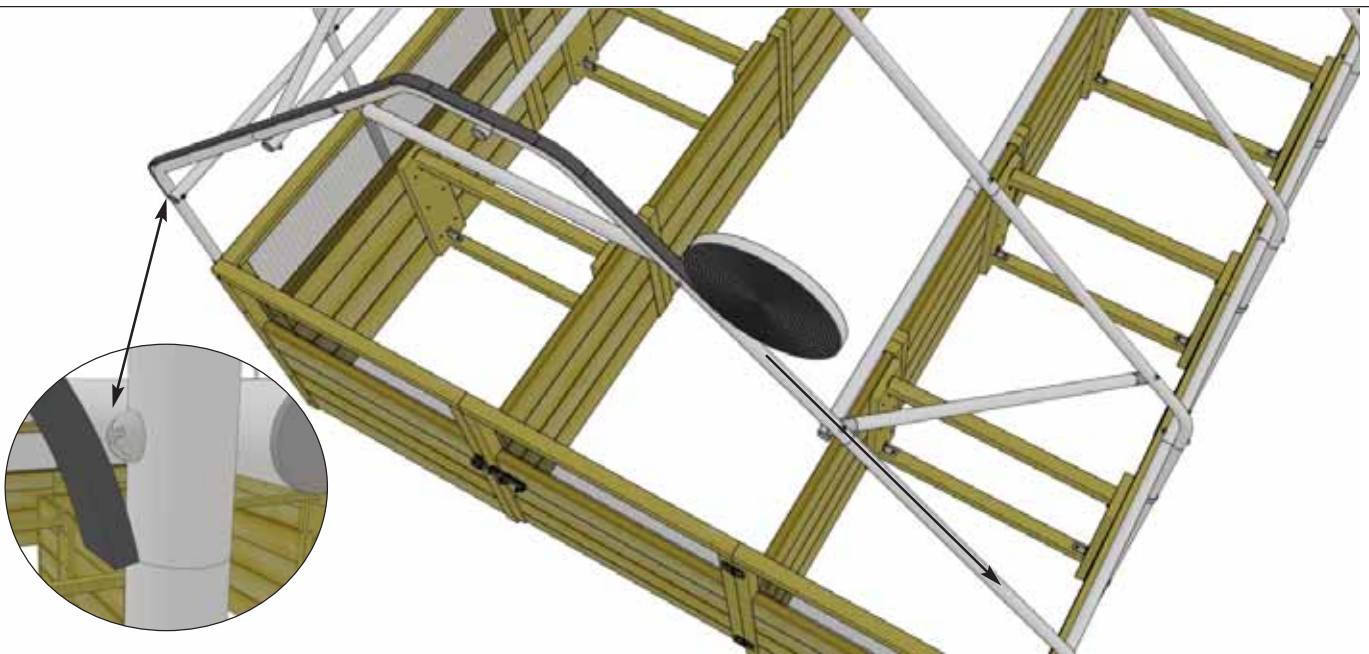

# Step 12

Note: To fit the Greenhouse Cover on the frame, you will need to open the doorway of the cover.

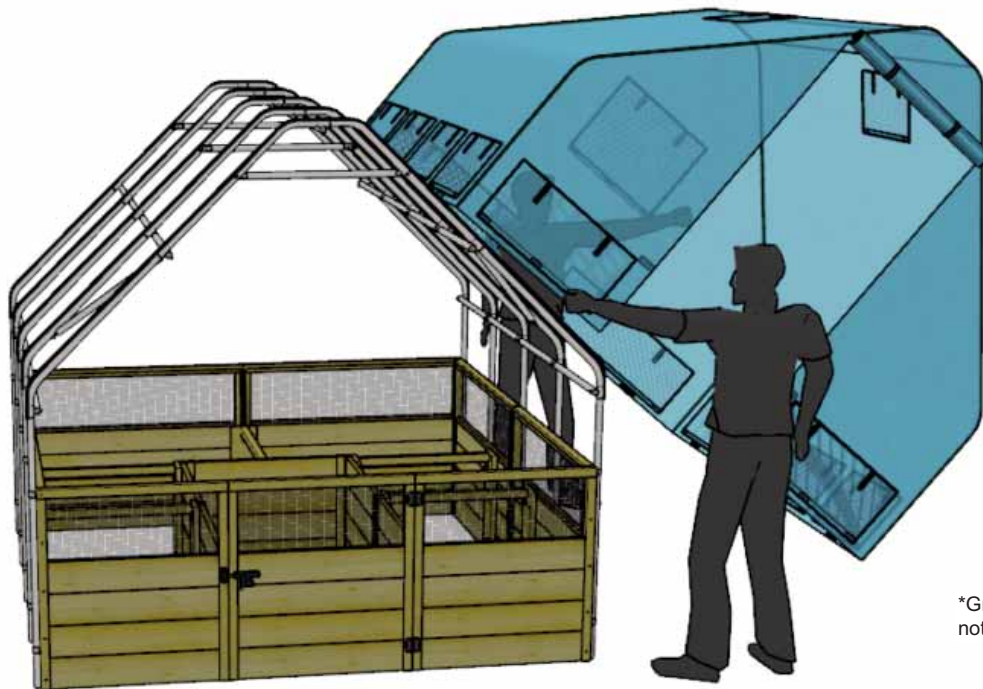

\*Greenhouse Cover is not actually rigid.

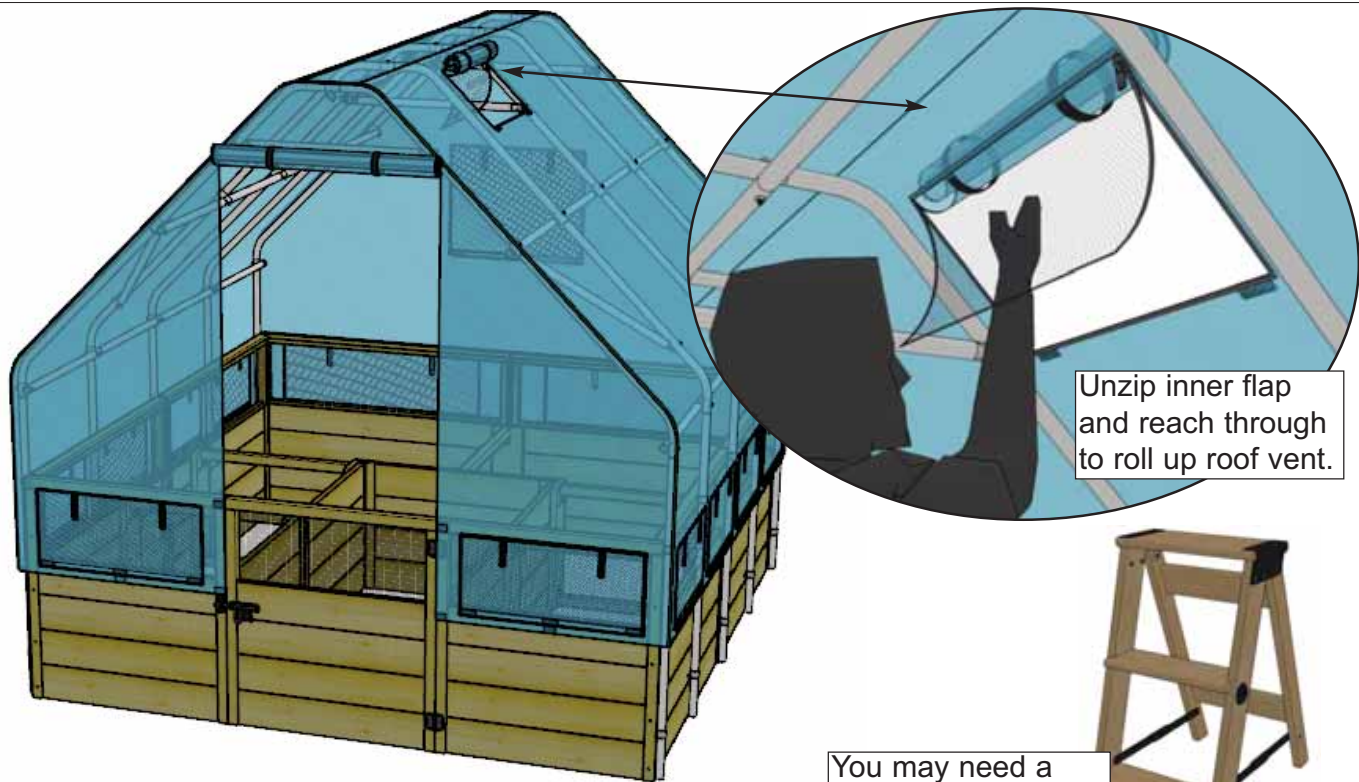

Unzip inner flap and reach through to roll up roof vent.

You may need a step ladder to reach the roof vents.

# Step 13

## Parts & Hardware

2 x Clips

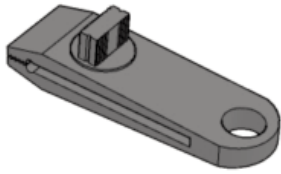

2 x 1 1/4" Pan Head Screws



2 x Washers

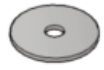

### Front of Unit

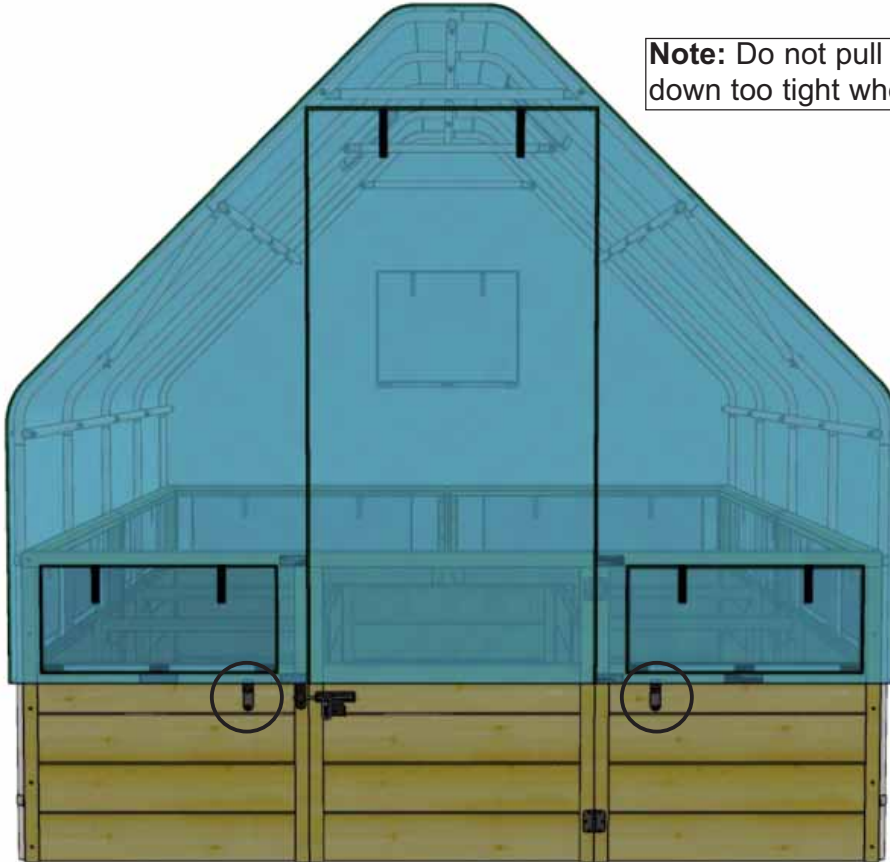

**Note:** Do not pull the Greenhouse Cover down too tight when attaching the clips.

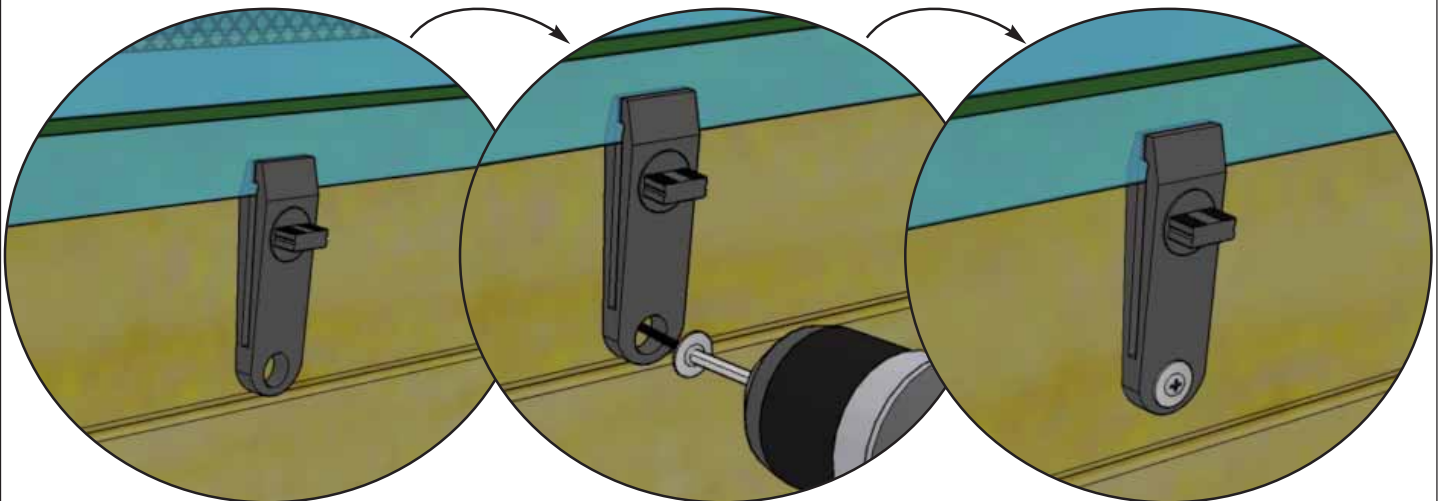



# Step 14

## Parts & Hardware

10 x Clips

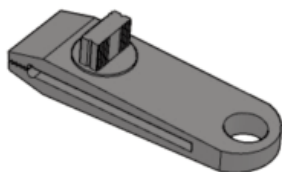

10 x 1 1/4" Pan Head Screws



10 x Washers



Right Side of Unit

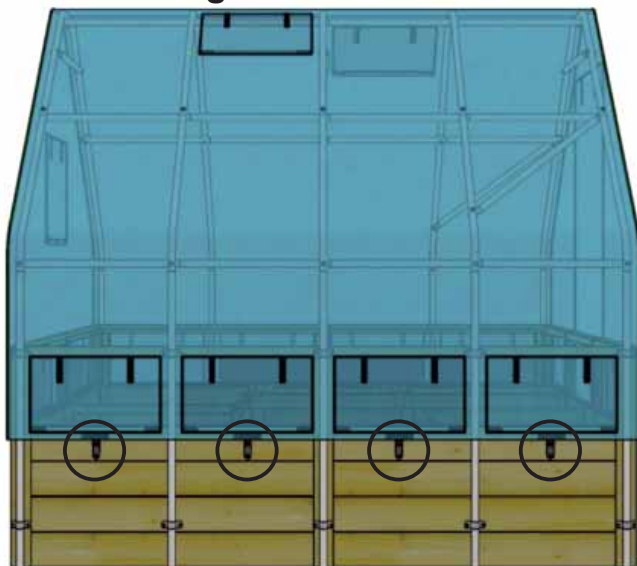

Left Side of Unit

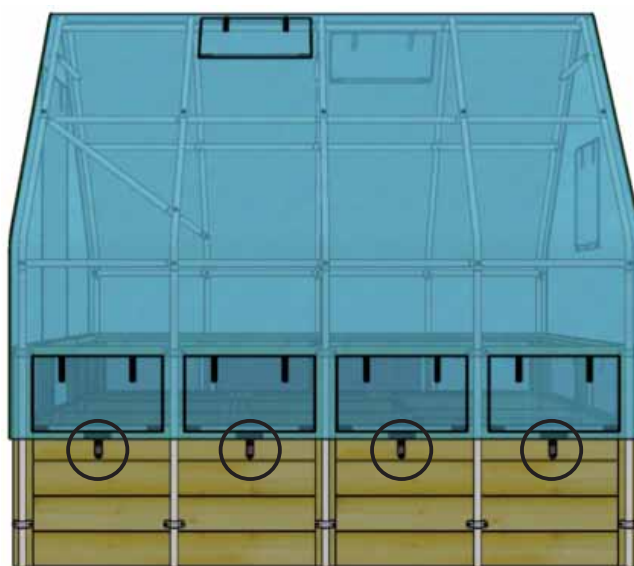

Rear of Unit

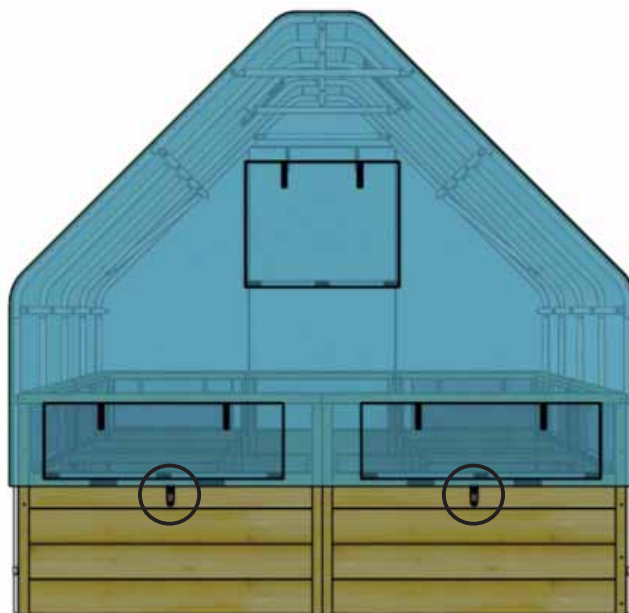



## Congratulations on assembling your 8x8 Garden in a Box with Greenhouse Cover!

We hope your experience assembling your 8x8 Garden in a Box with Greenhouse Cover has been both positive and rewarding.

We value your feedback and would like to hear back from you on how well we are doing in the following areas:

1. Customer Service
2. On Time Shipping
3. Motor Freight Delivery
4. Quality of Materials
5. Assembly Manual
6. Overall Satisfaction.



Please call, write or email us at:

Outdoor Living Today

Canadian Address  
9393 287th Street  
Maple Ridge, British Columbia  
Canada V2W 1L1

United States Address  
P.O. Box 96  
Sumas, Washington  
USA 98295



The materials contained in this Assembly Manual may be downloaded or copied provided that ALL copies retain the copyright and any other proprietary notices contained on the materials. No material may be modified, edited or taken out of context such that its use creates a false or misleading statement or impression as to the positions, statements or actions.