



Bird Netting Cover

for 8x8 Garden in a Box

Assembly Manual

Version #1.1
Jan 3, 2022

Thank you for purchasing a Bird Netting Cover for your 8x8 Garden in a Box. Please take the time to identify all the parts prior to assembly.

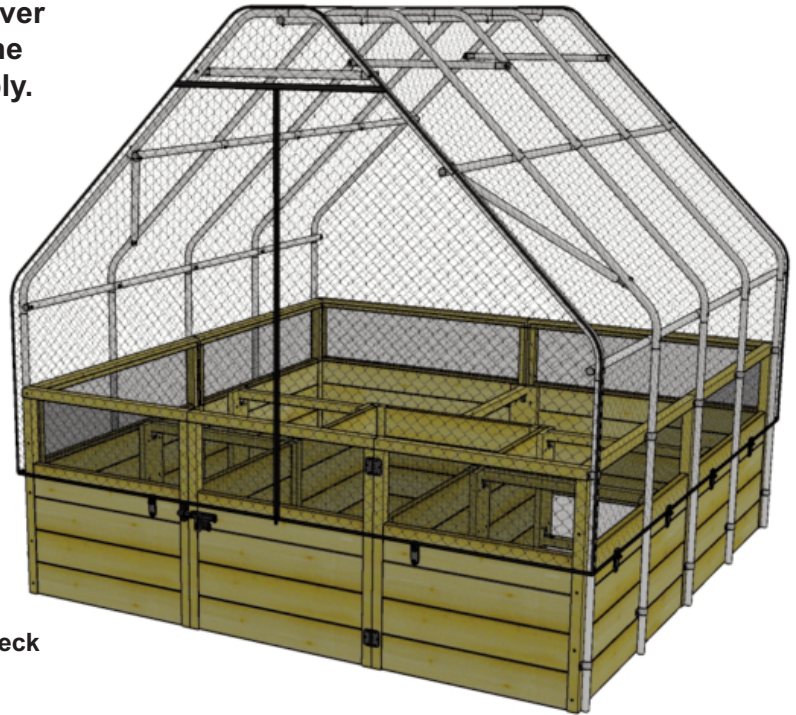

We recommend once a year in the early spring to check that all fasteners are snug and to tighten if loose.

Any small rips or tears that occur in the netting either by accidental damage or by natural wear and tear over time can be repaired by pinching the two nearest intact sections together and banding with a zip tie.











Customer agrees to hold Outdoor Living Today and any Authorized Dealers free of any liability for improper installation, maintenance and repair.

In the event of a missing or broken piece, call the Outdoor Living Today Customer Support Line @ 1-888-658-1658 within 30 days of the delivery of your purchase. It is our commitment to you to courier replacement parts, free of charge, within 10 business days of this notification. Replacement parts will not be provided free of charge after the 30 day grace period.

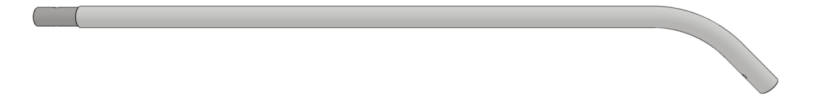
All structures purchased from Outdoor Living Today are covered for a period of one year for defects in manufacturing and workmanship. Costs incurred for customer installations are not included.

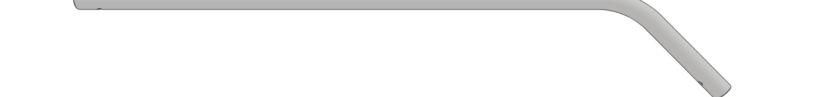
Failure to use supplied parts included in this kit could result in poor product performance and may void your warranty. Please contact Outdoor Living Today's Customer Toll Free Line if you plan to deviate from our written instructions.

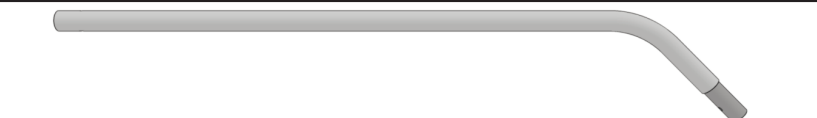
Thank you for purchasing a Bird Netting Cover for your 8x8 Garden in a Box. Please take the time to identify all the parts prior to assembly.

Part 1		x 10
Part 2		x 5
Part 3		x 10
Part 4		x 5
Part 5		x 5
Part 6		x 8
Part 7		x 2
Part 8		x 2
Part 9		x 3
Part 10		x 2
Part 11		x 3

Hardware

& Miscellaneous

1 x Phillips Bit



2 x M6x60

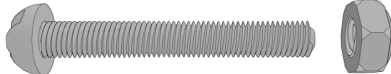

23 x M6x55

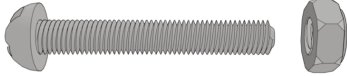

8 x M6x35

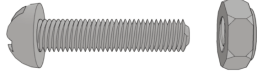

12 x Clips

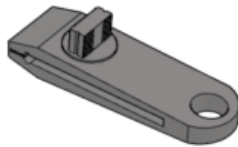

12 x Washers



12 x 1" Screws



40 x 5/8" Screws



Bird Netting Cover

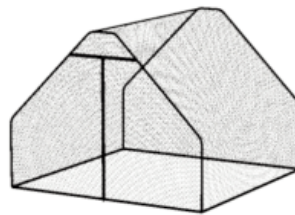

20 x Pipe Clamps



1 x Tape Roll

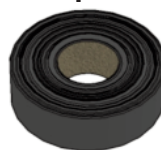

Tools Required

(Not Provided)

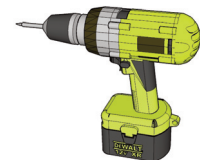

Screw Gun/Drill



Pliers



Phillips Screwdriver

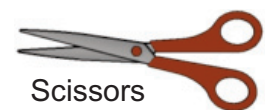

Scissors

Exploded View

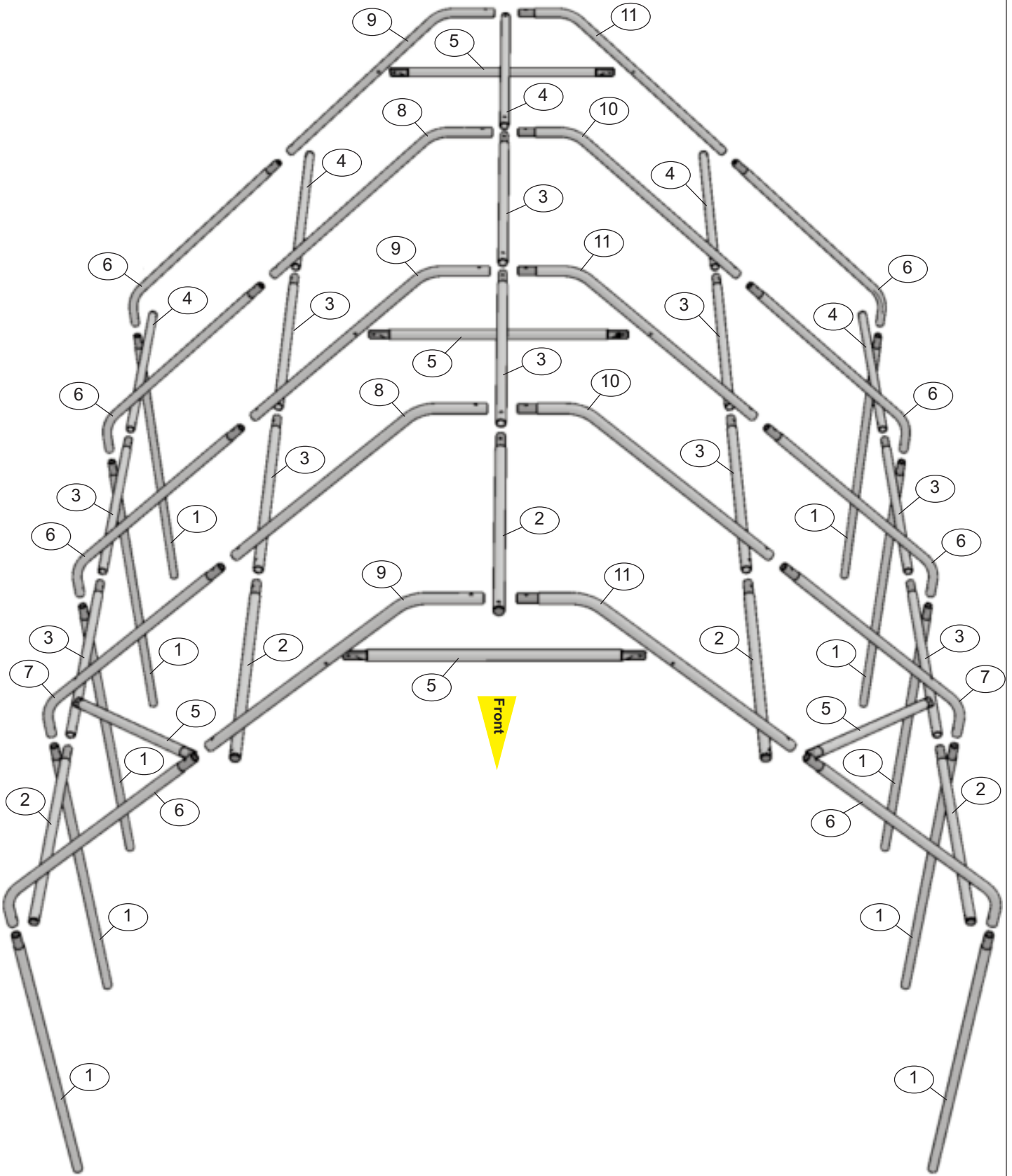

Step	Parts & Hardware	
	1	1 x Part 4
1 x Part 9		
		1 x M6x55

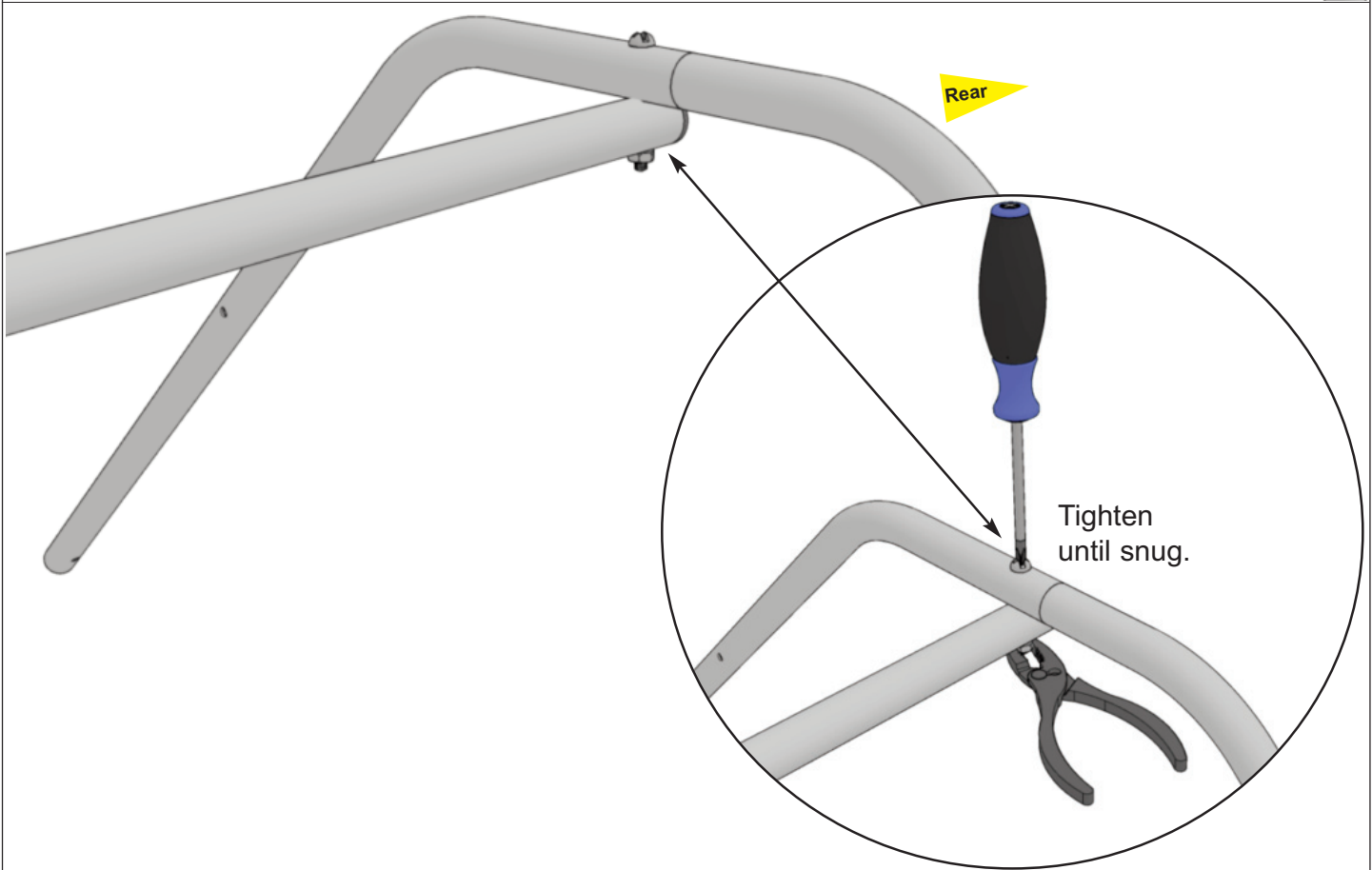
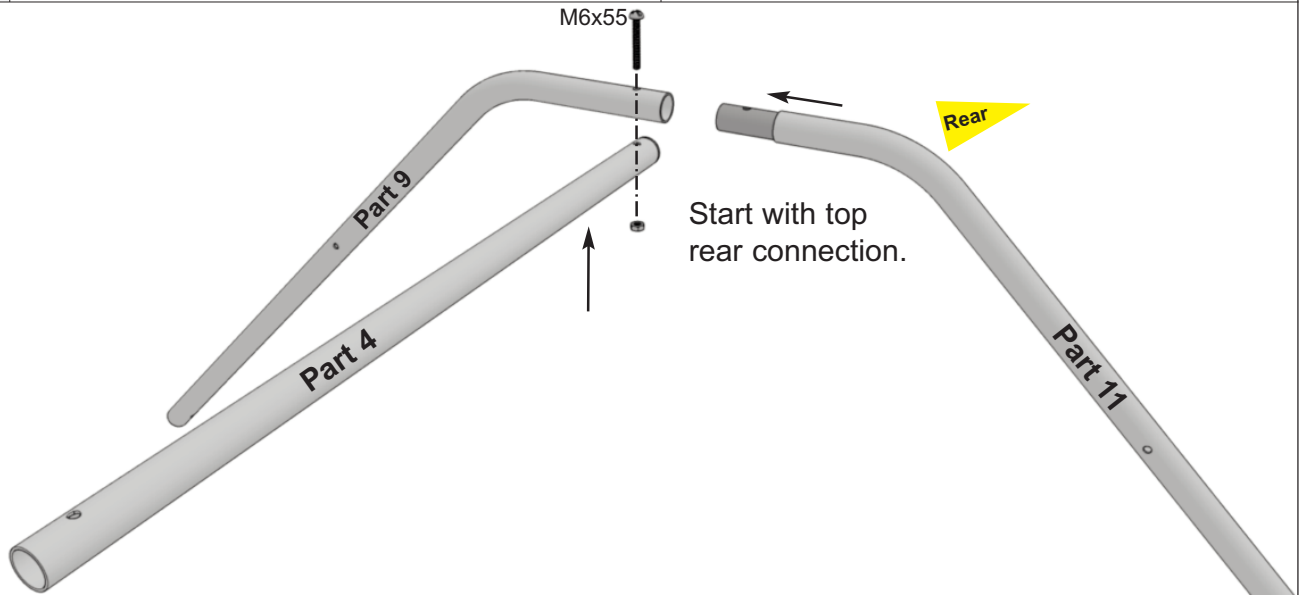

Step
2

Parts & Hardware

1 x Part 5



2 x M6x35

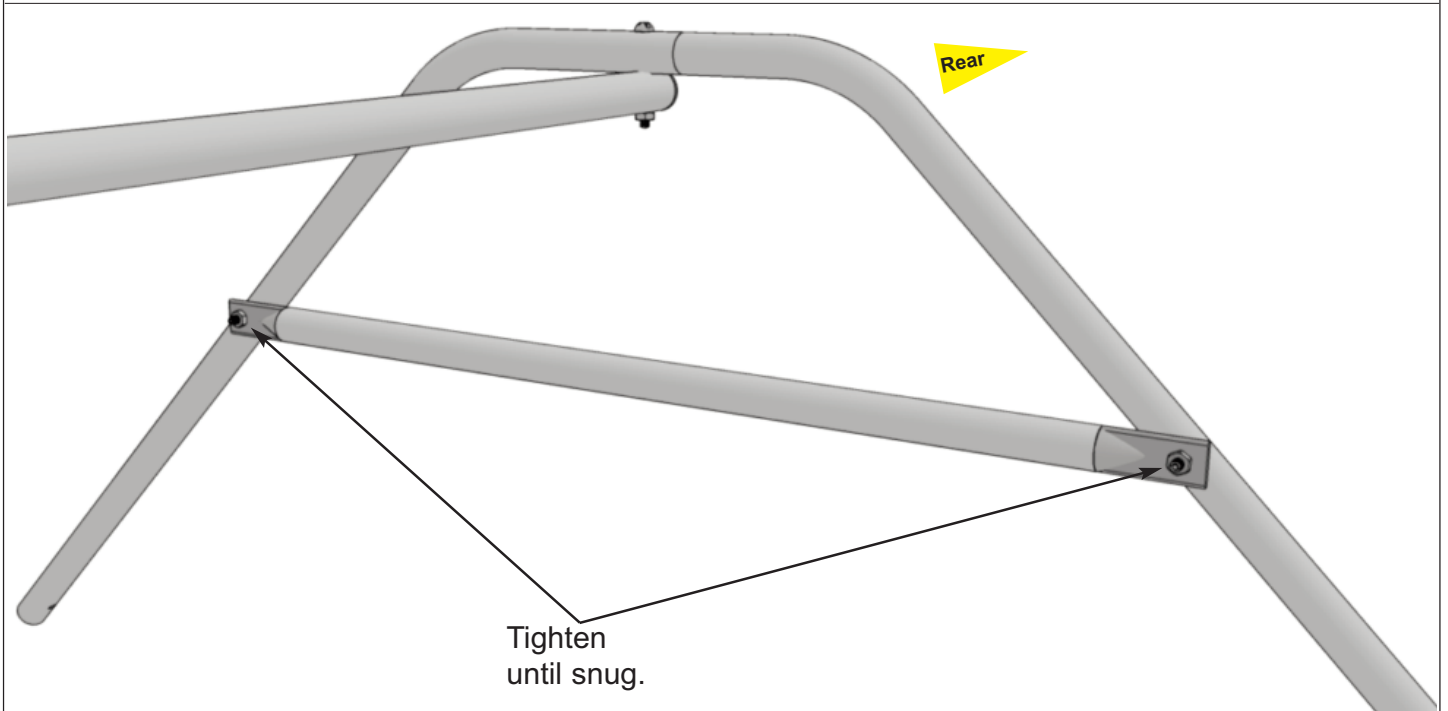
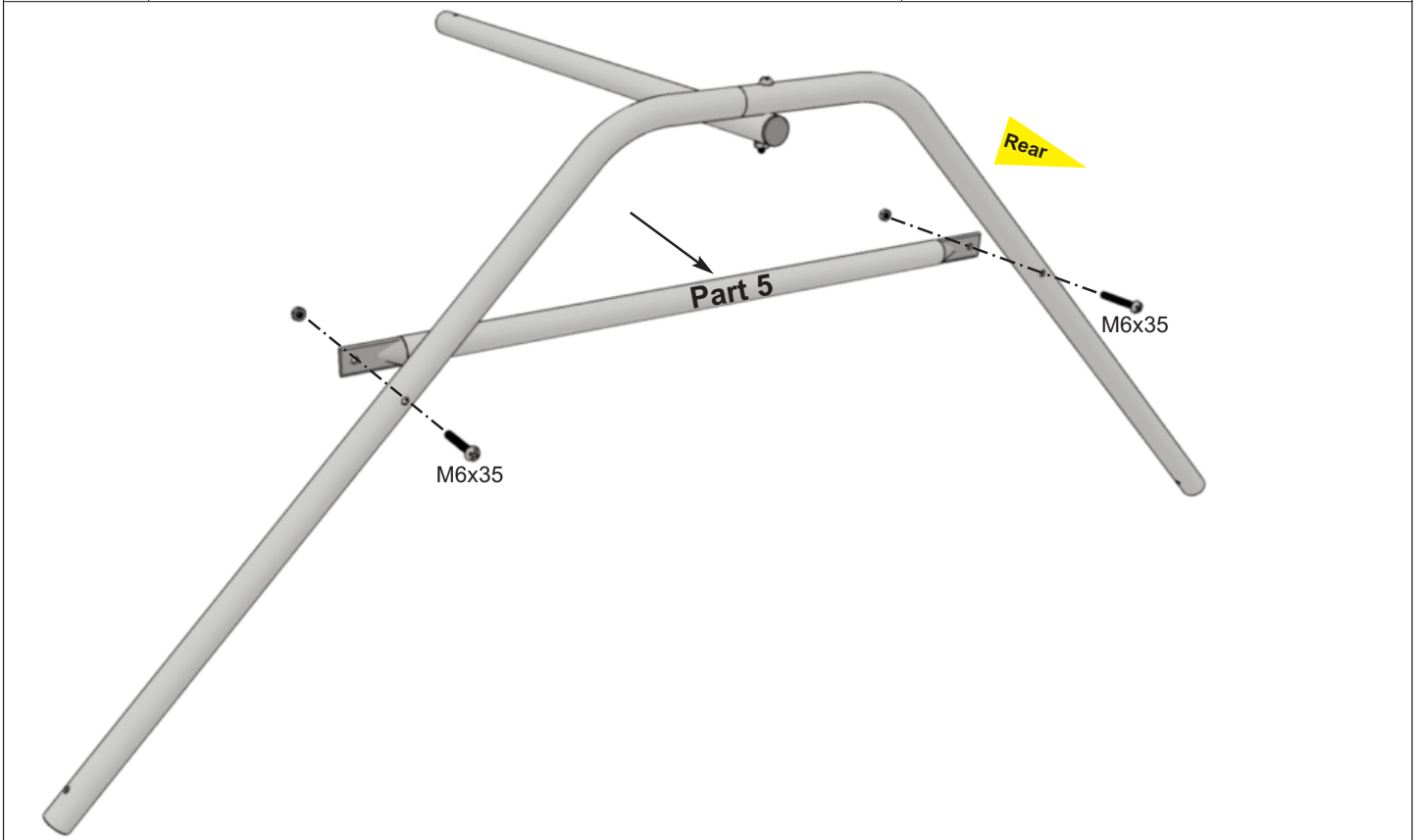
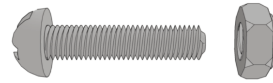

Step 3

Parts & Hardware

1 x Part 3



1 x Part 10

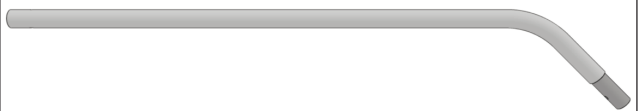

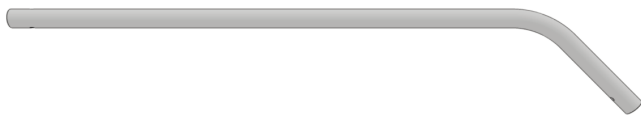

1 x Part 8

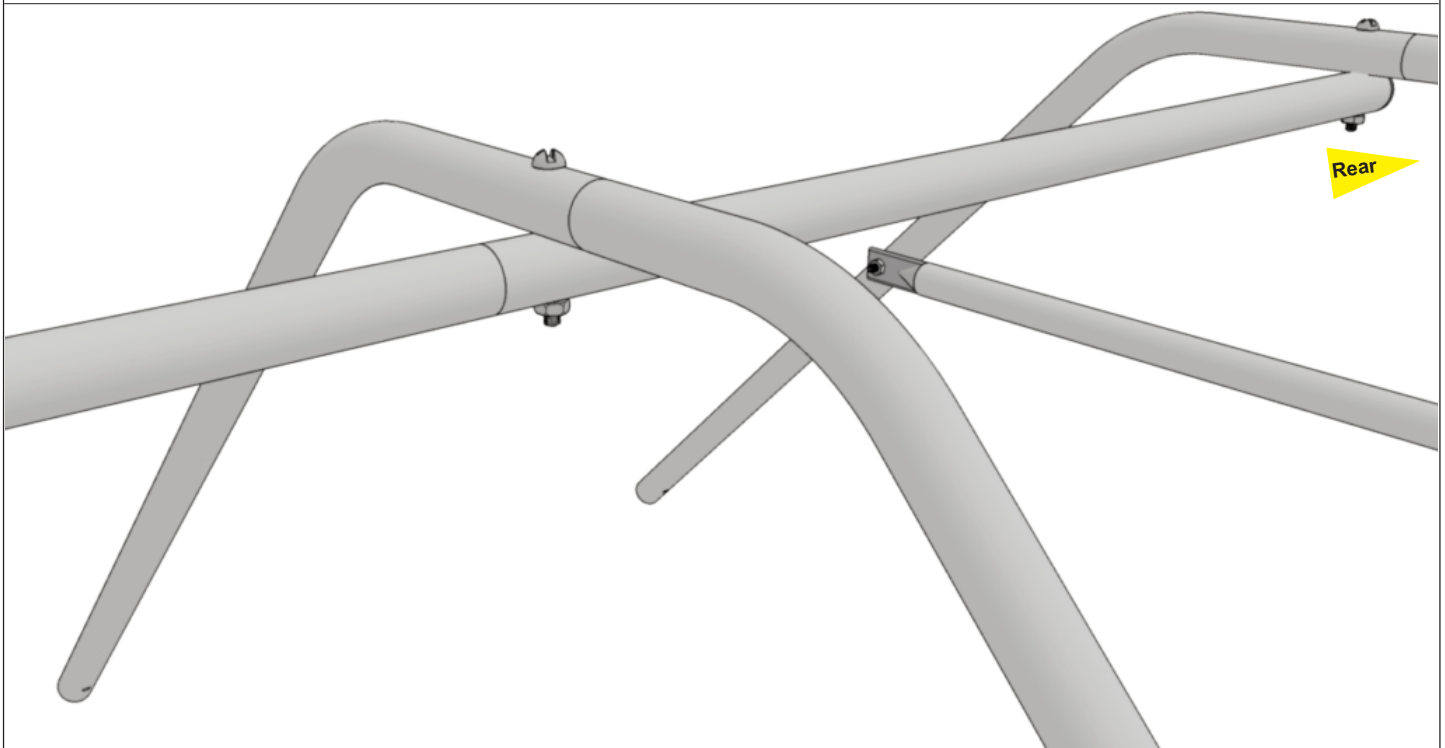
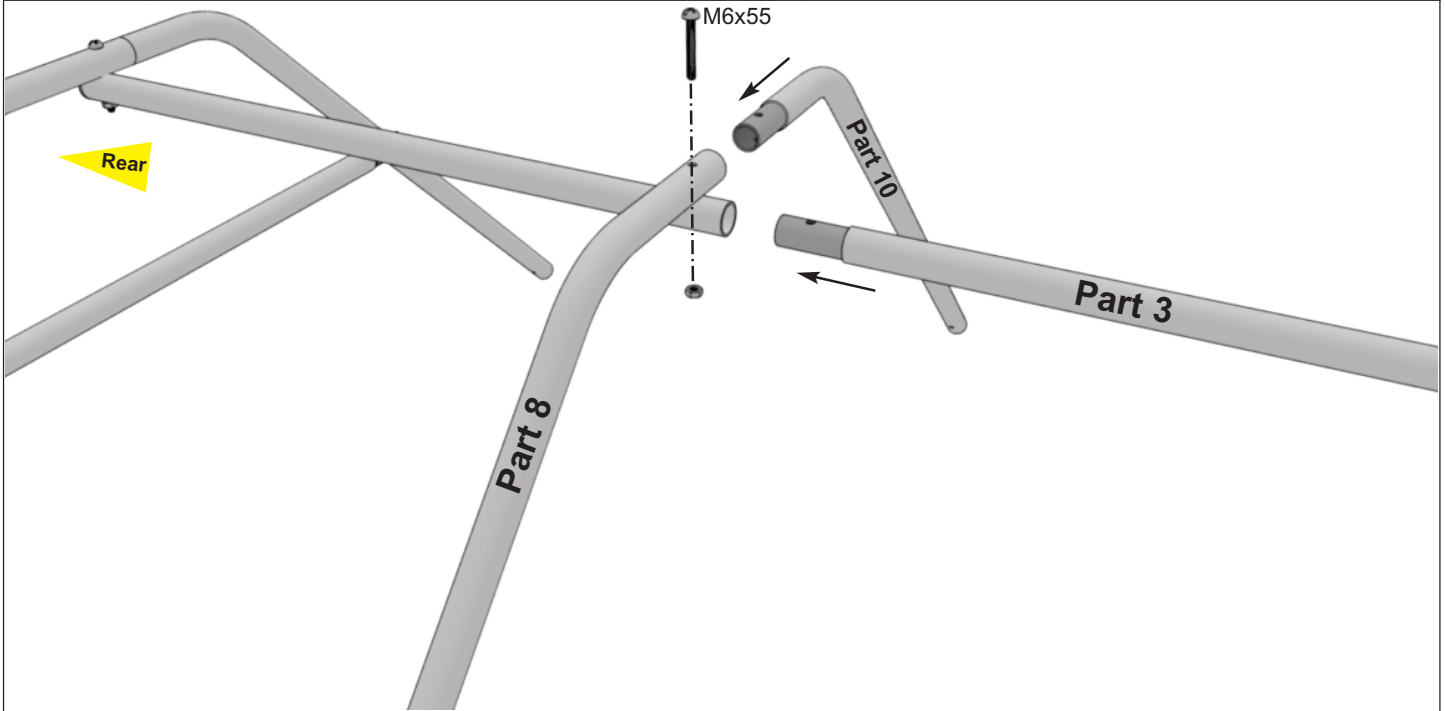
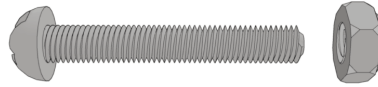

1 x M6x55

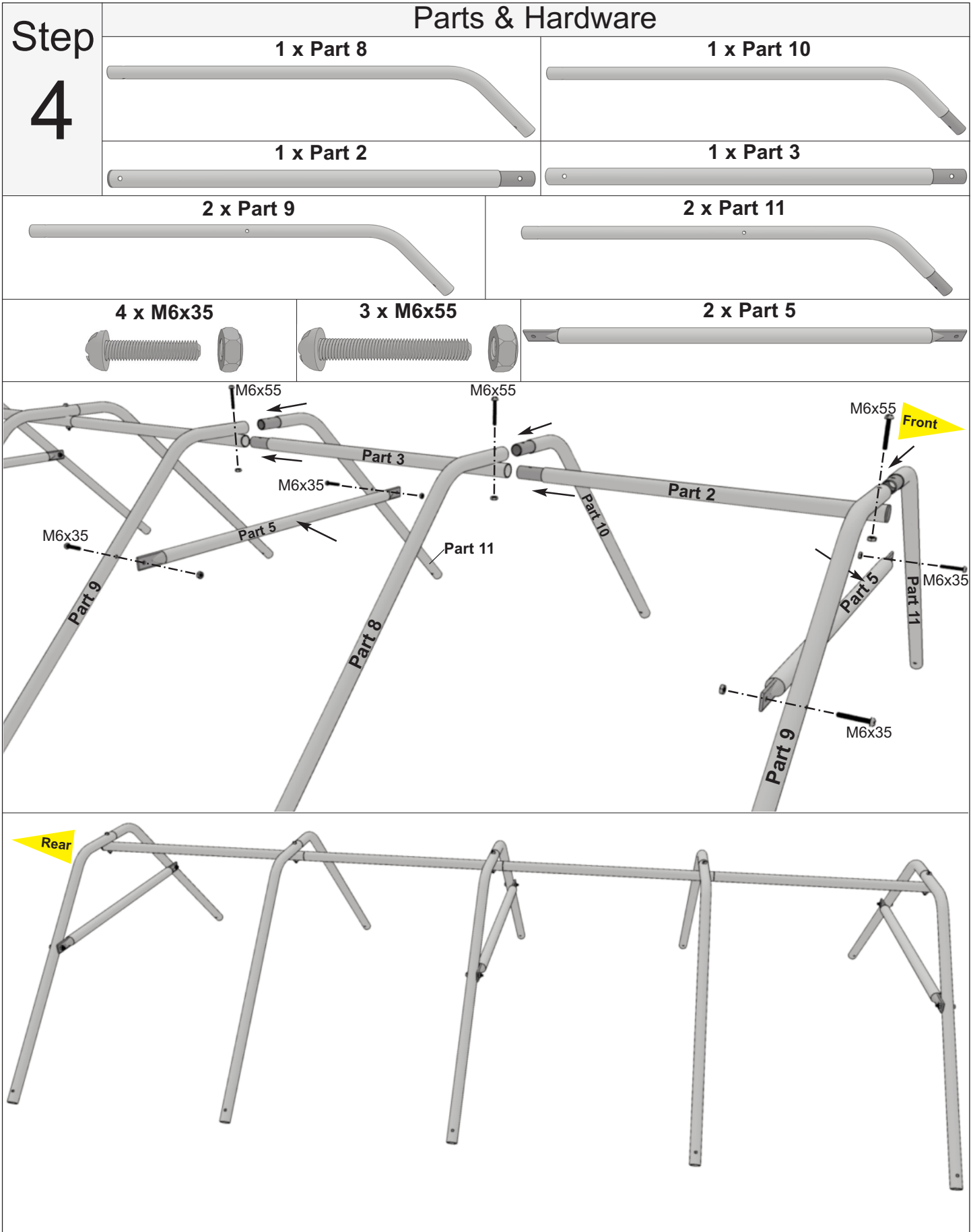

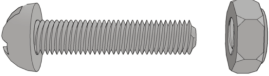

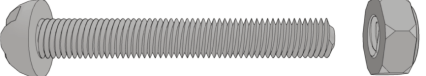
Step	Parts & Hardware		
	5	1 x Part 7	4 x Part 6
1 x Part 4		1 x Part 3	
1 x Part 2		2 x Part 5	
1 x M6x35		4 x M6x55	1 x M6x60
			

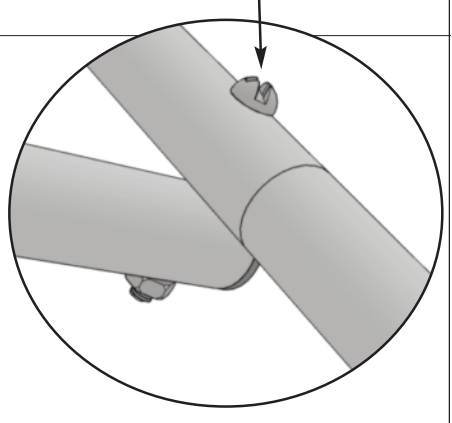
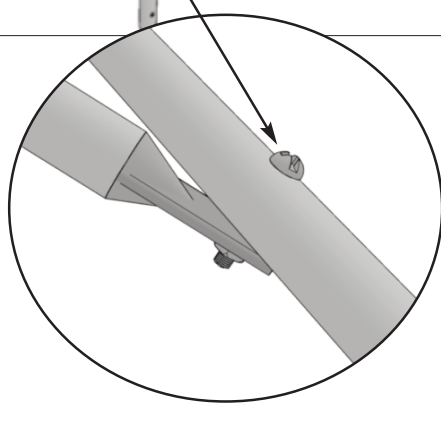
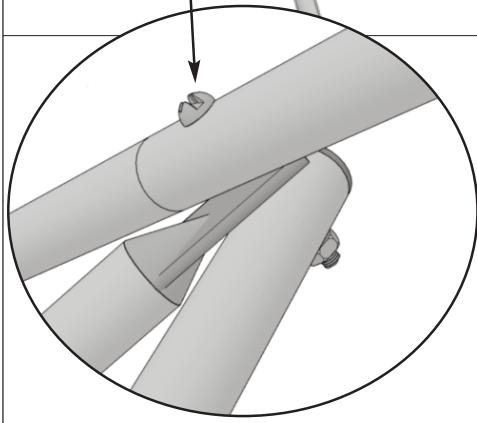
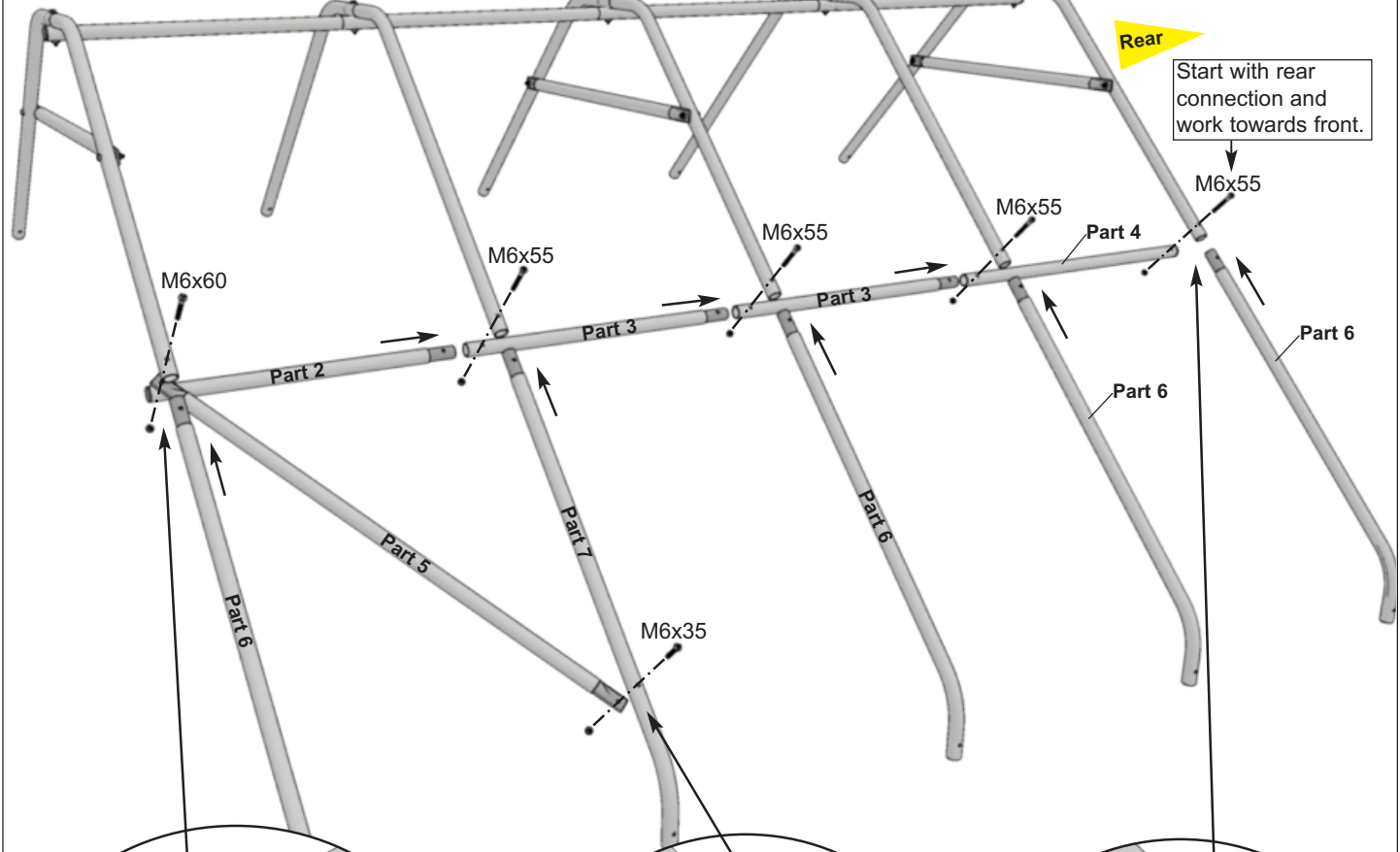

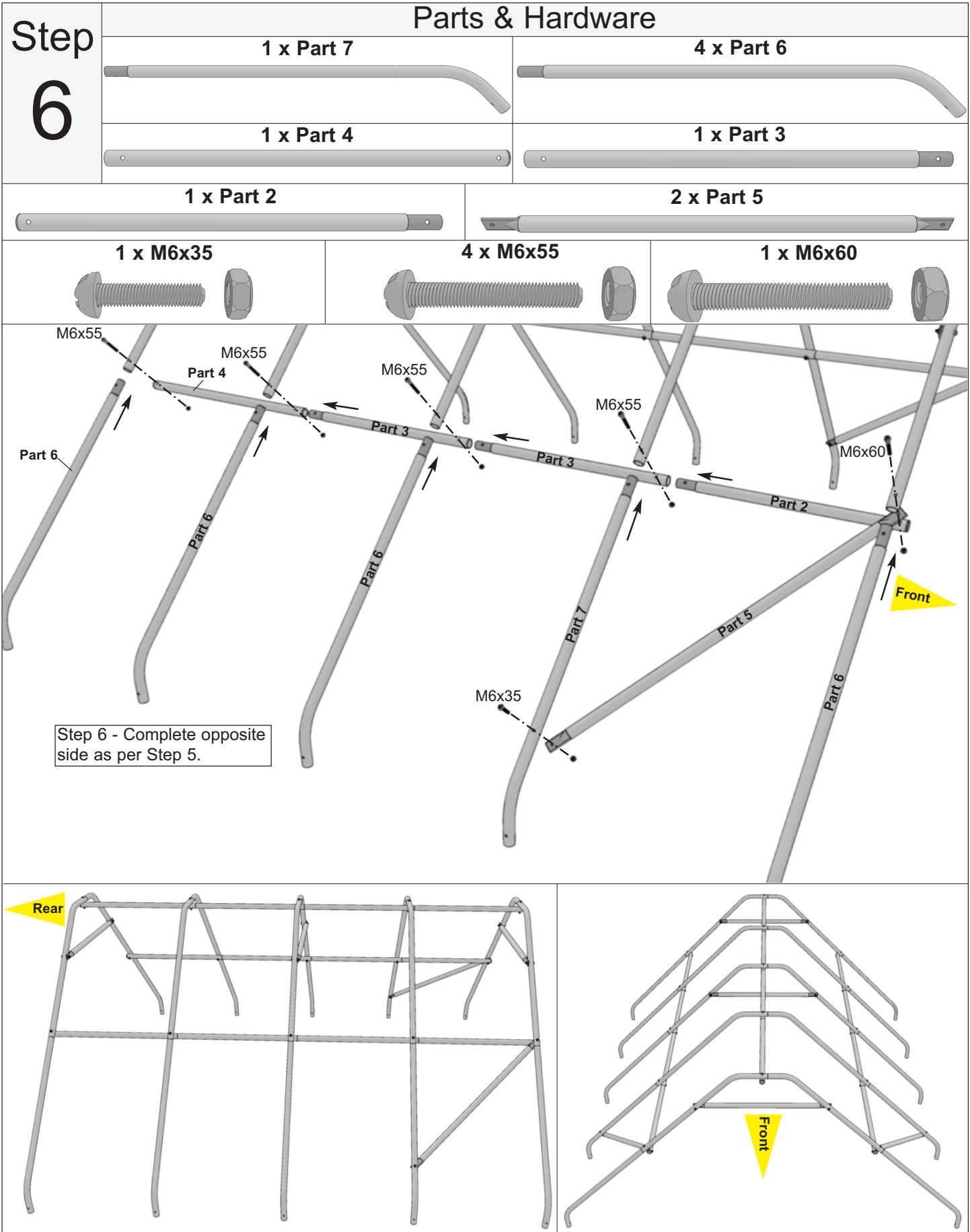

Step

7

Parts & Hardware

2 x Part 2

2 x Part 4

4 x Part 1

4 x M6x55

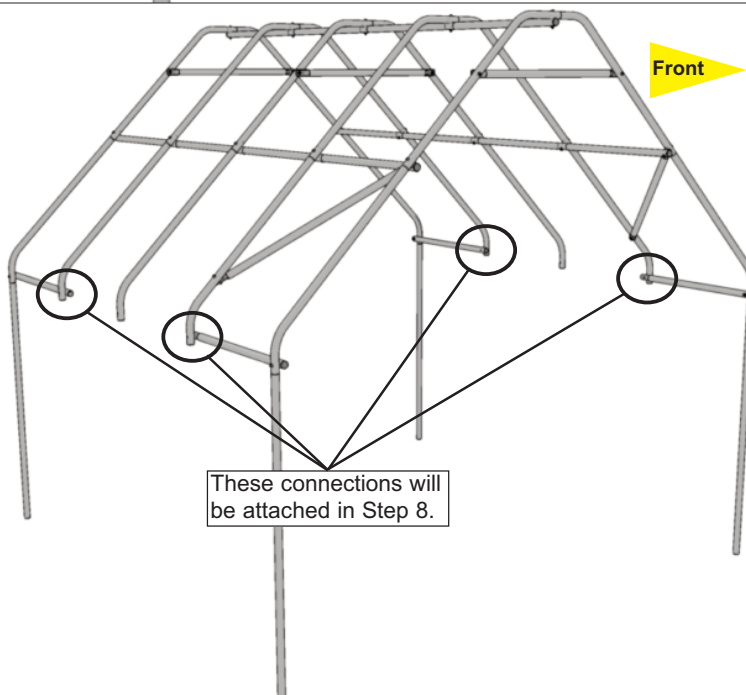
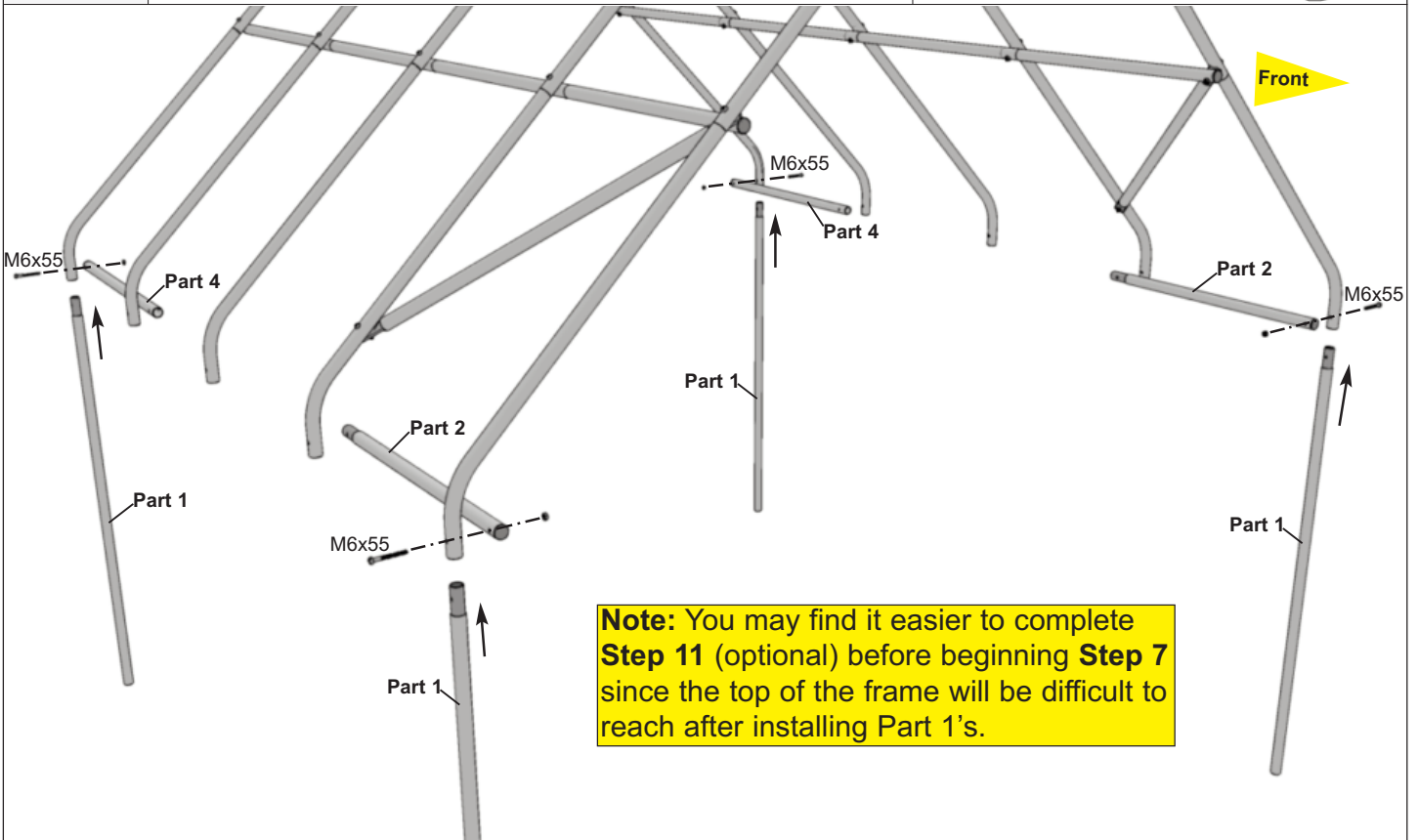

Step 8

Parts & Hardware

4 x Part 3

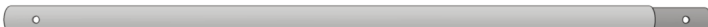

6 x M6x55

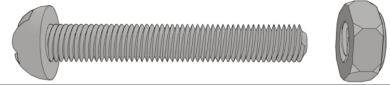

6 x Part 1

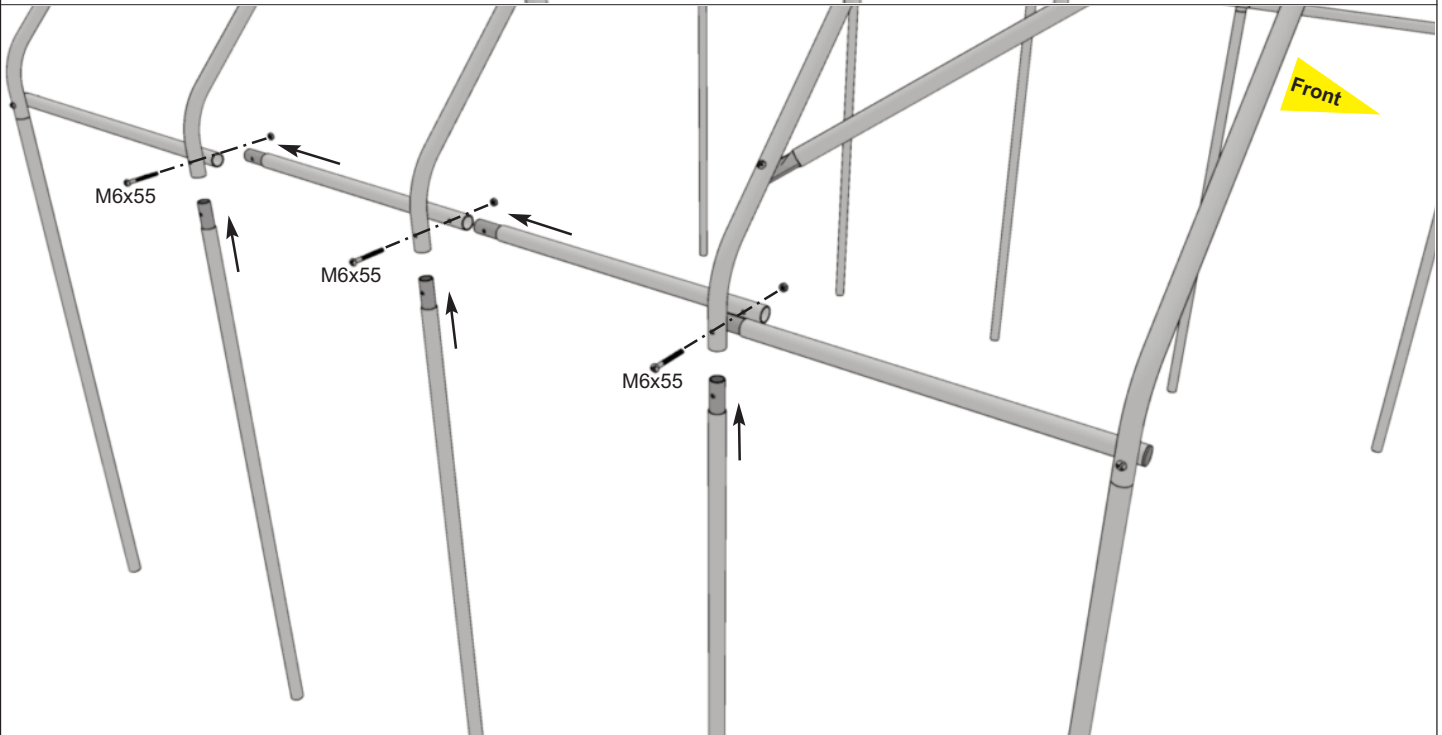
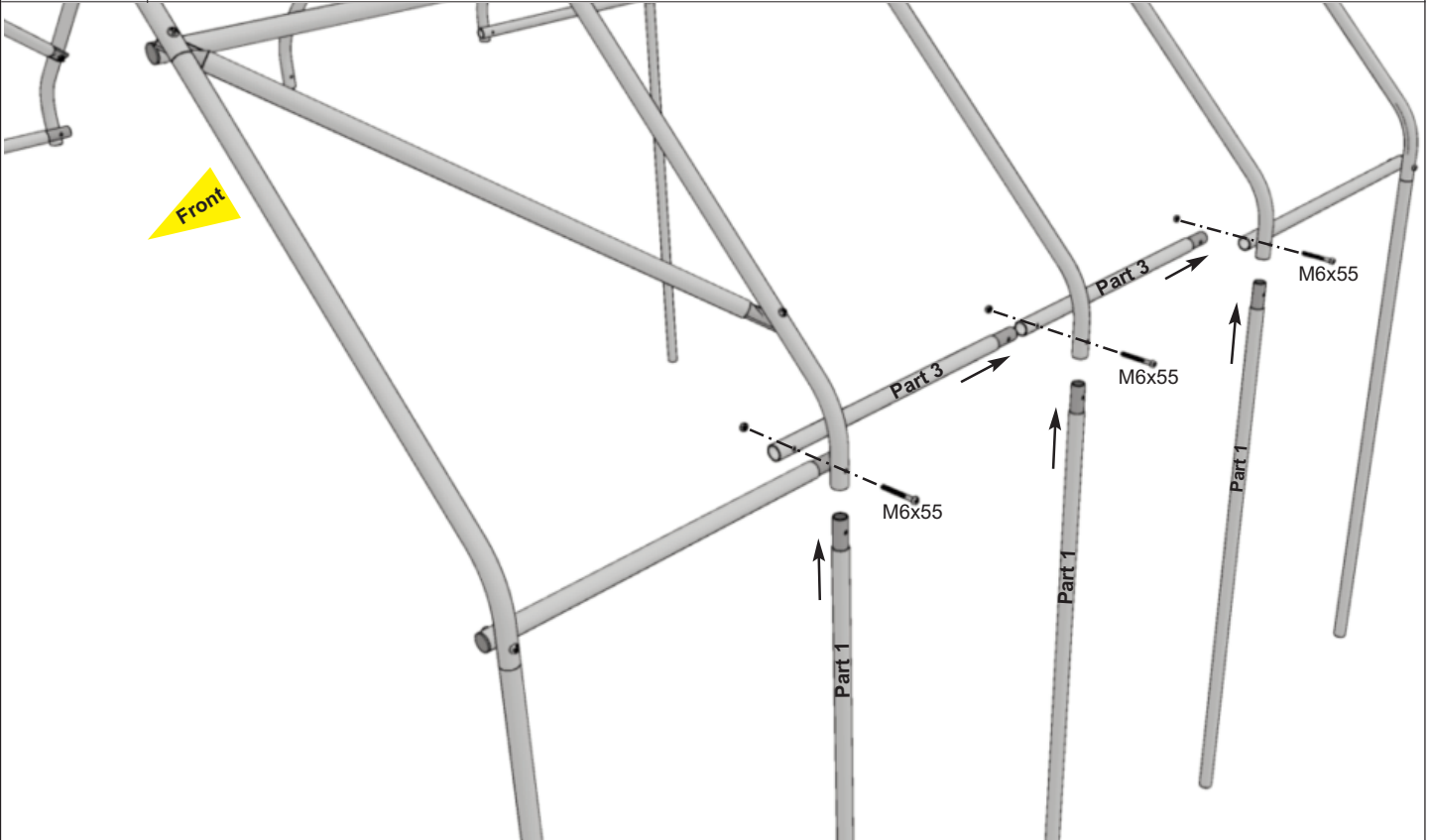

Step 9

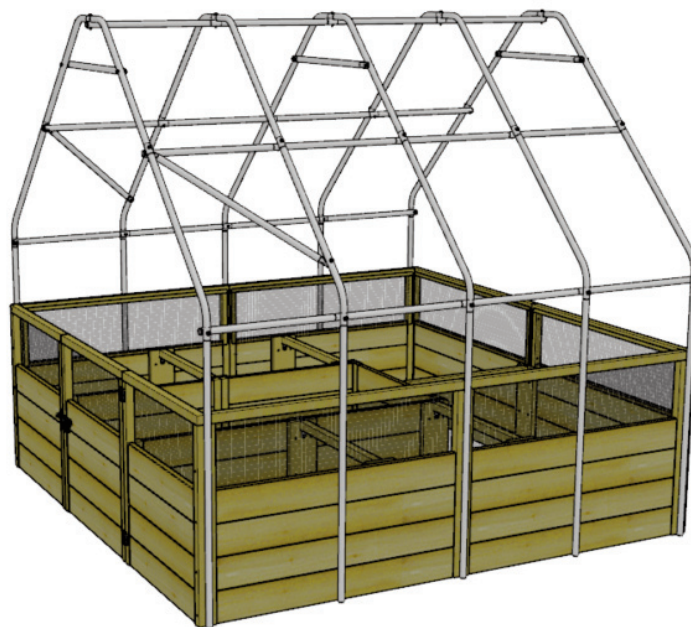
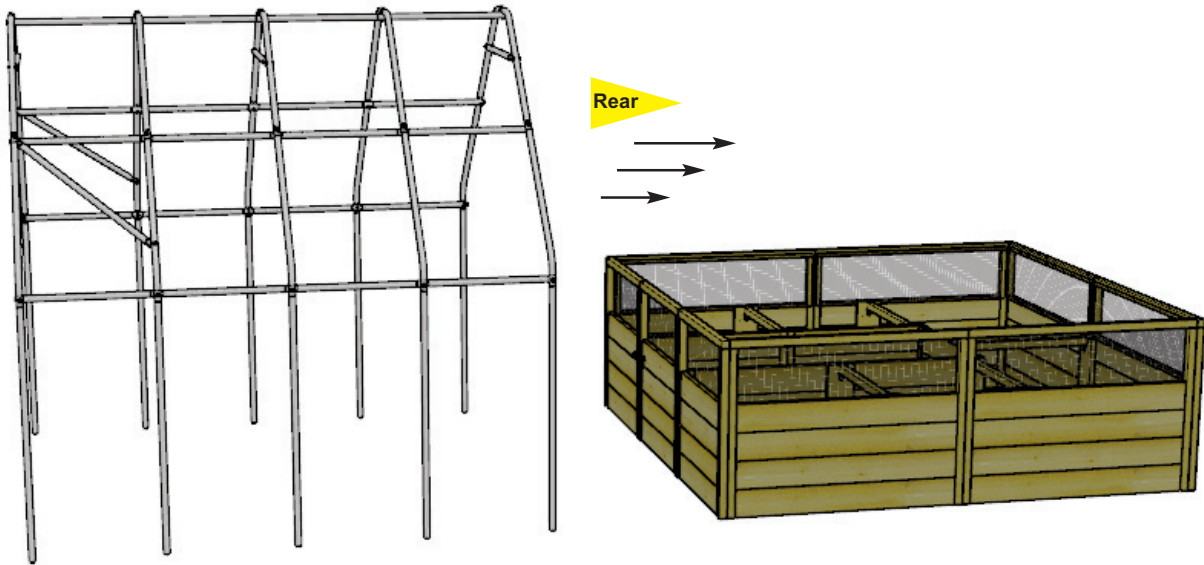

Step
10

Parts & Hardware

20 x Pipe Clamps

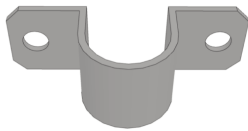

40 x 5/8" Screws

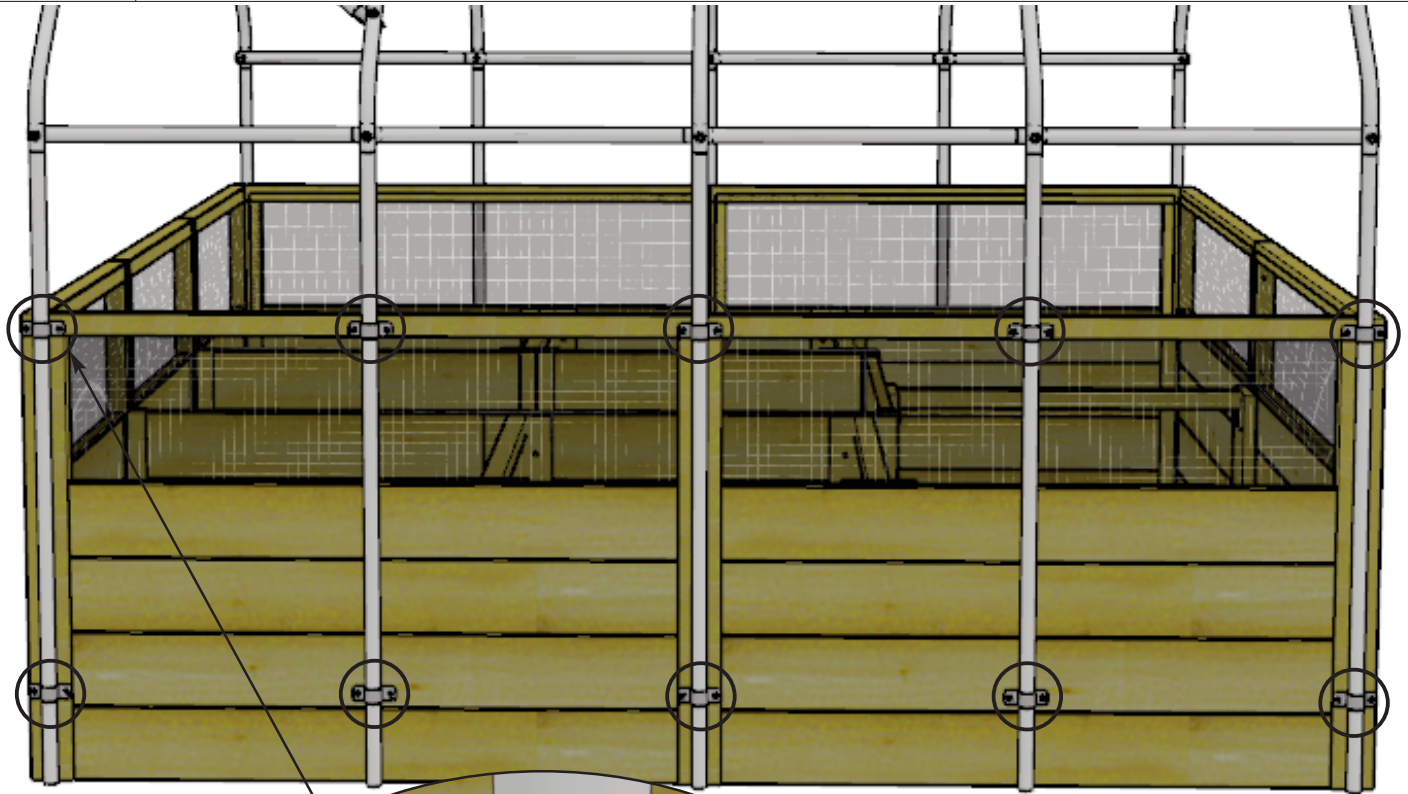

Note: Pre-drill pilot holes to prevent splitting.

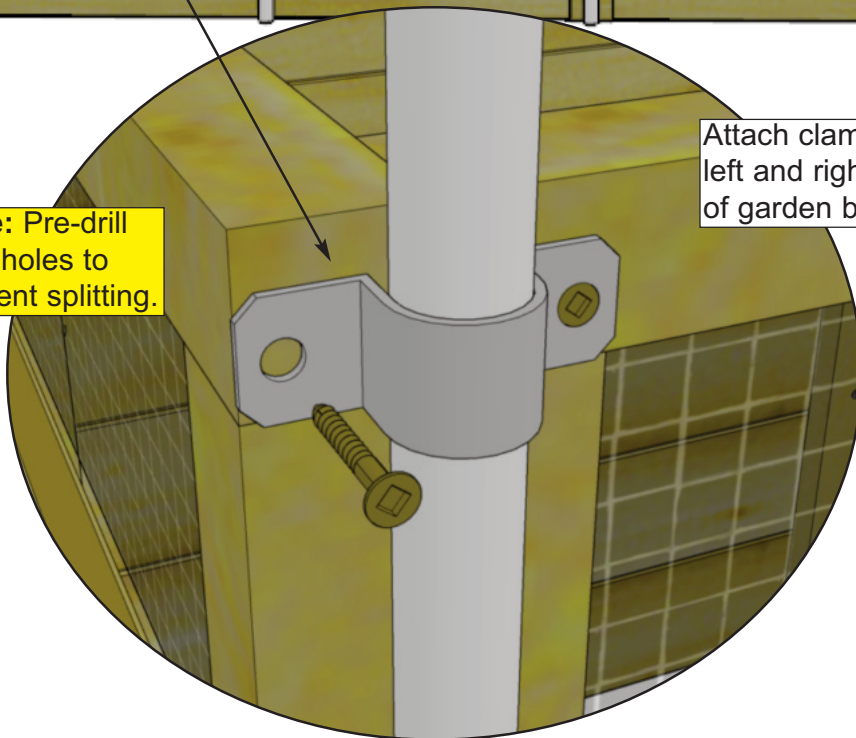

Attach clamps on left and right side of garden bed.

Step

11 - Optional

Parts & Hardware

Note: You may want to cover each exposed bolt head on the exterior of the frame with a short strip of black tape (included). This will make the next step easier by preventing the Bird Netting from getting caught on the bolts when you put it onto the frame.

1 x Tape Roll

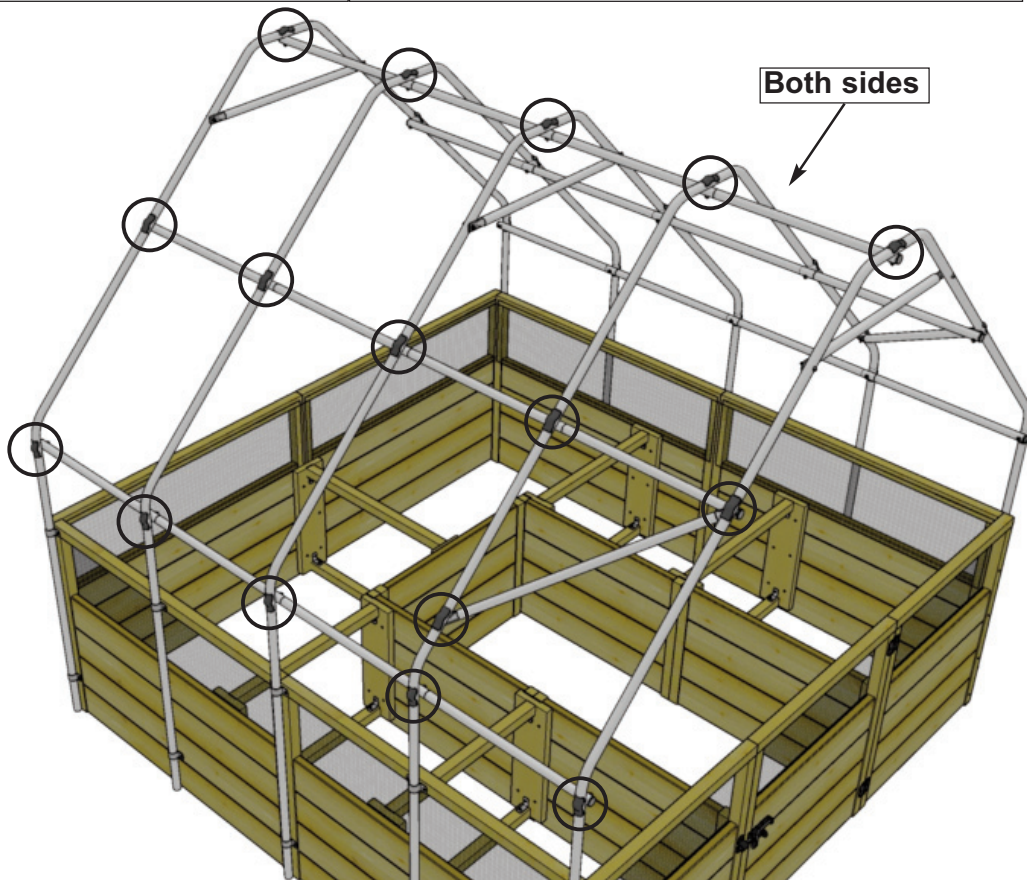
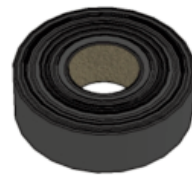

Both sides

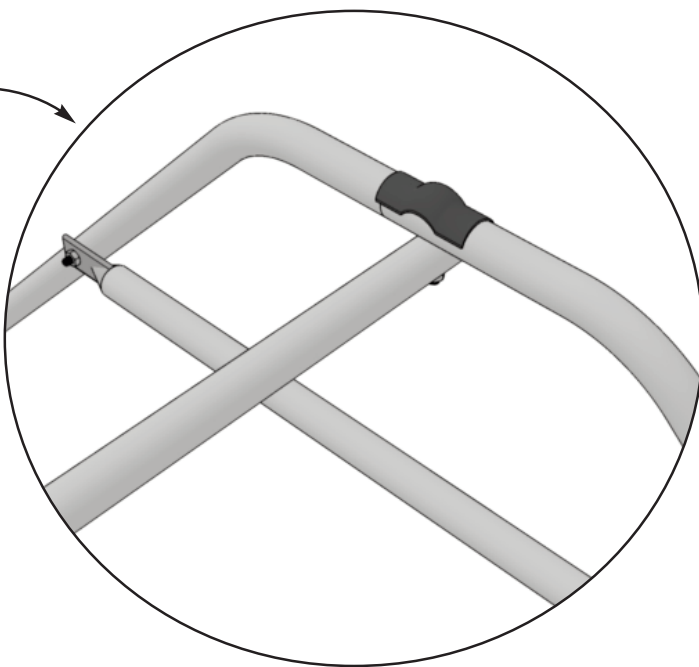
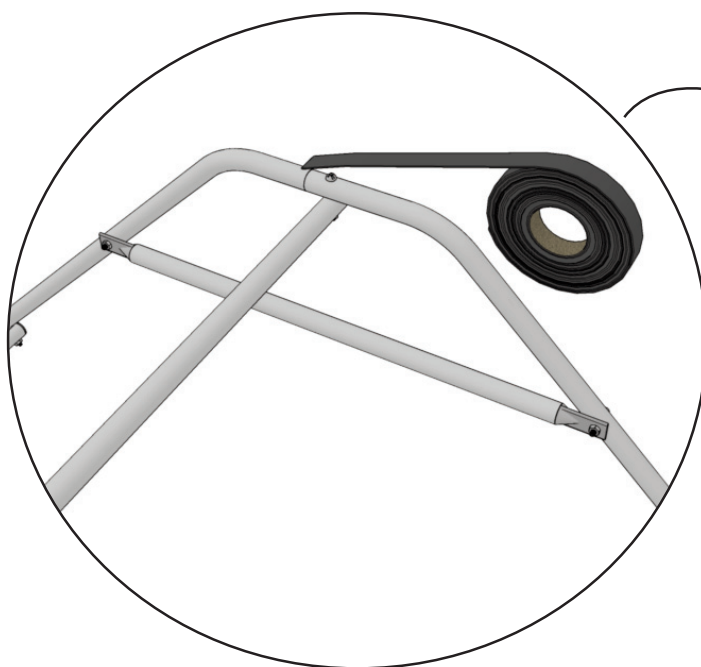

Step 12

Note: To fit the Bird Netting Cover on the frame, it will help to open the doorway before putting it on.

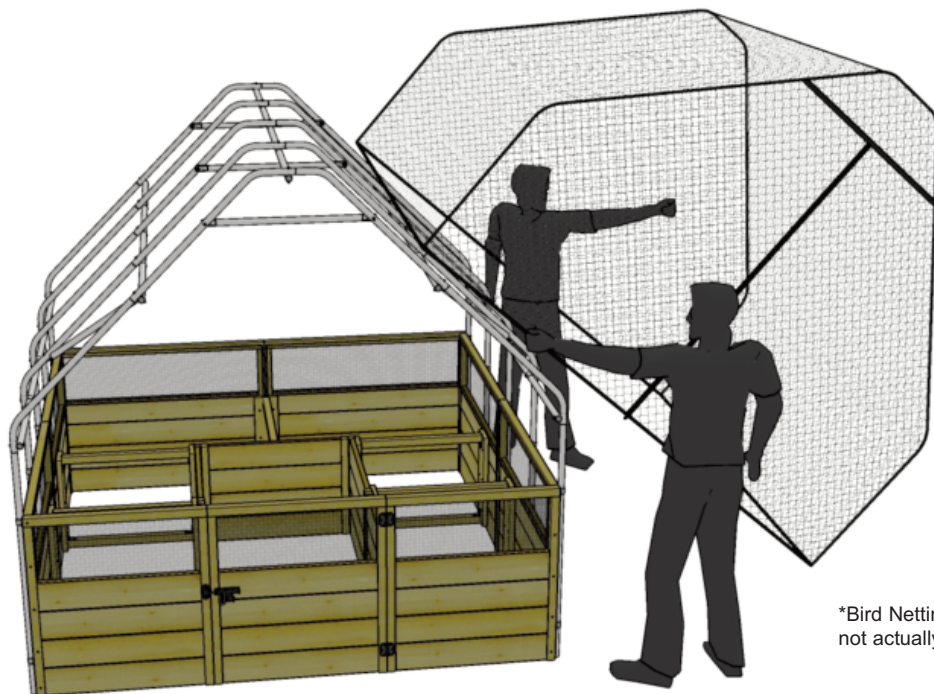

*Bird Netting Cover is not actually rigid.

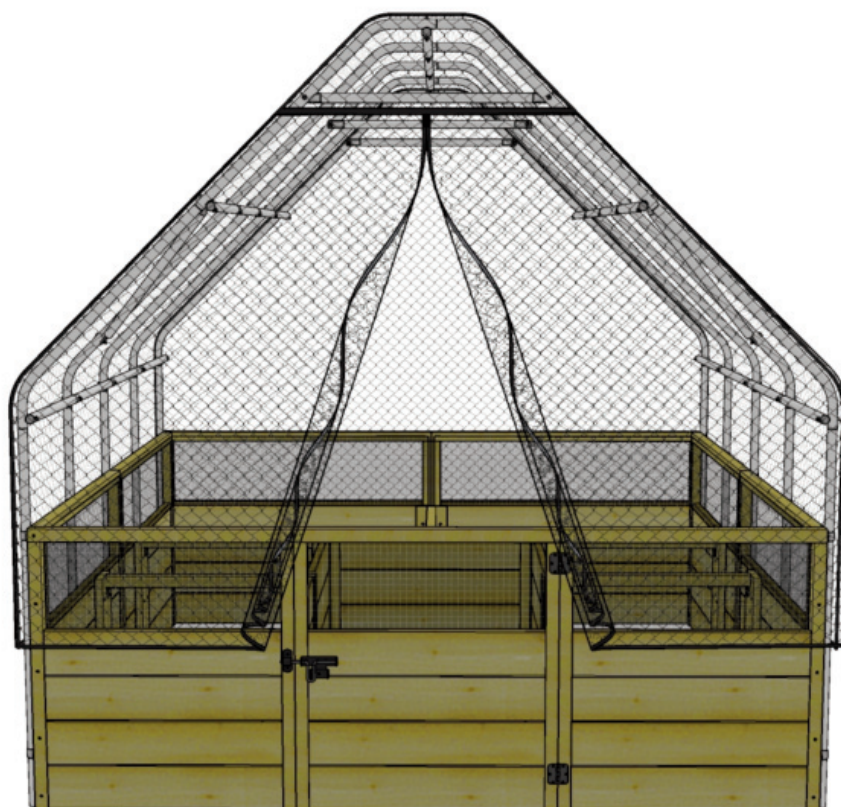

Step 13

Parts & Hardware

2 x Clips

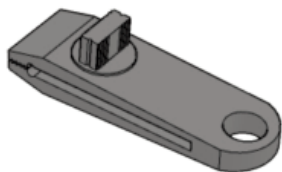

2 x 1" Screws



2 x Washers

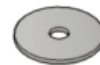

Front of Unit

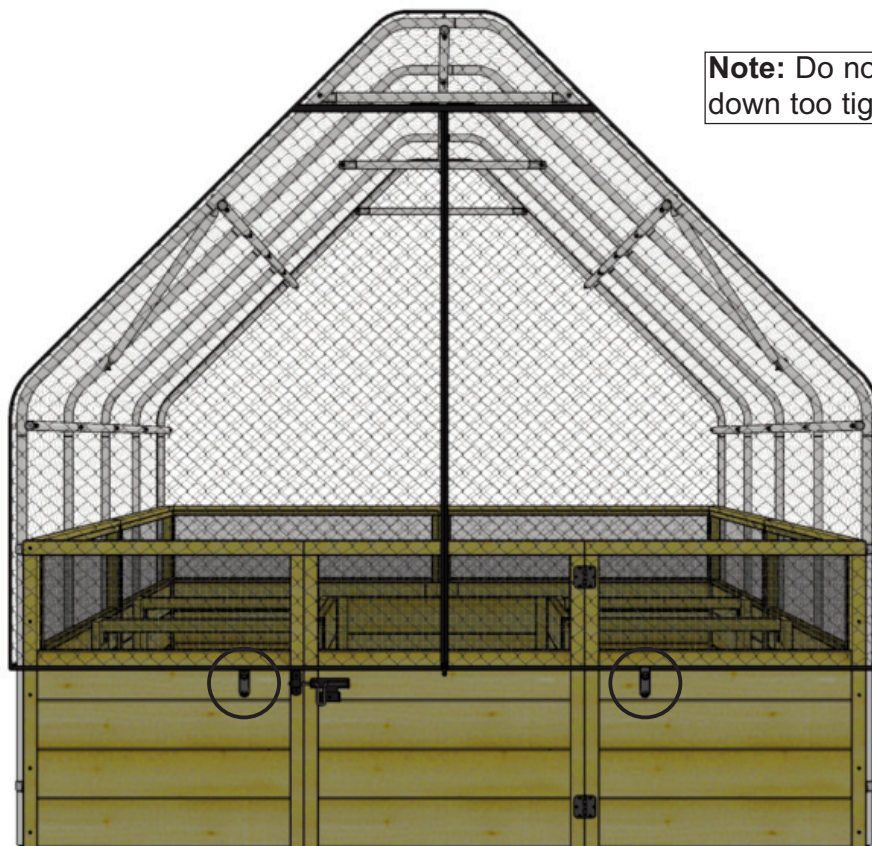

Note: Do not pull the Bird Netting Cover down too tight when attaching the clips.

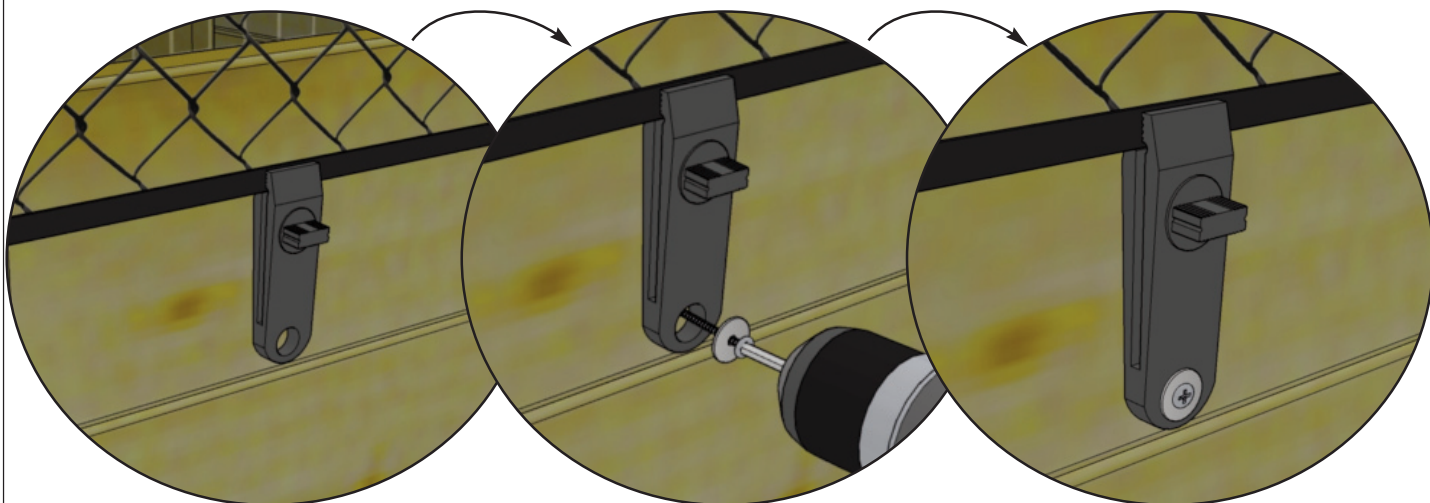

Step 14

Parts & Hardware

10 x Clips

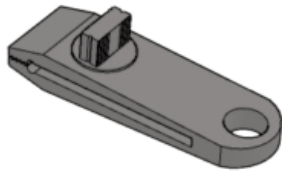

10 x 1" Screws



10 x Washers

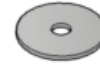

Right Side of Unit

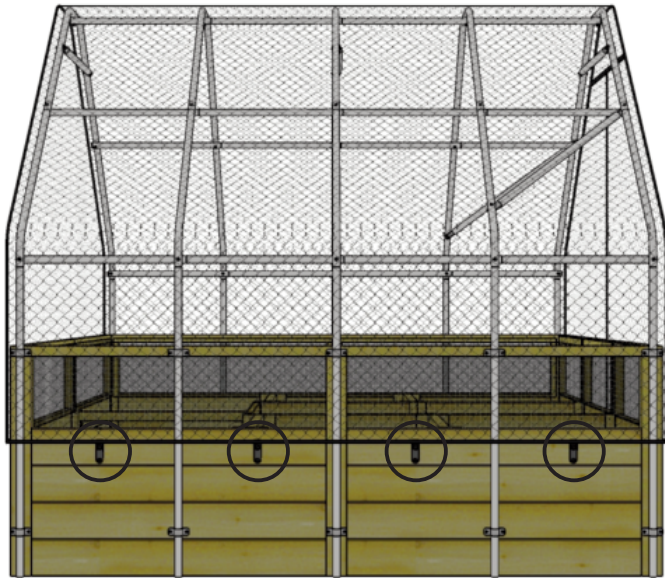

Left Side of Unit

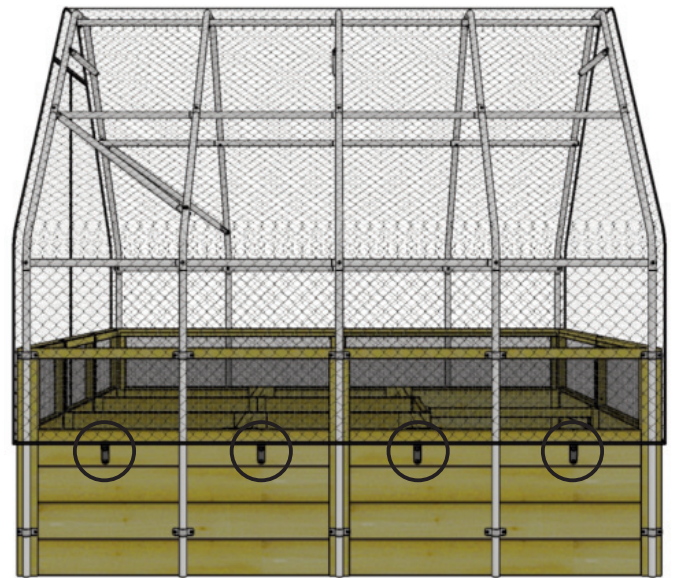

Rear of Unit

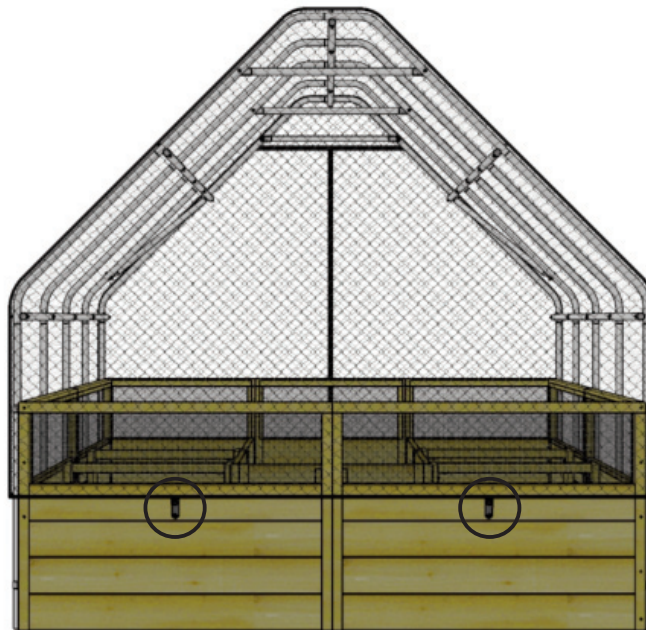



Congratulations on assembling your Bird Netting Cover for your 8x8 Garden in a Box!

We hope your experience assembling your 8x8 Garden in a Box with Bird Netting Cover has been both positive and rewarding.

We value your feedback and would like to hear back from you on how well we are doing in the following areas:

- 1. Customer Service**
- 2. On Time Shipping**
- 3. Motor Freight Delivery**
- 4. Quality of Materials**
- 5. Assembly Manual**
- 6. Overall Satisfaction.**

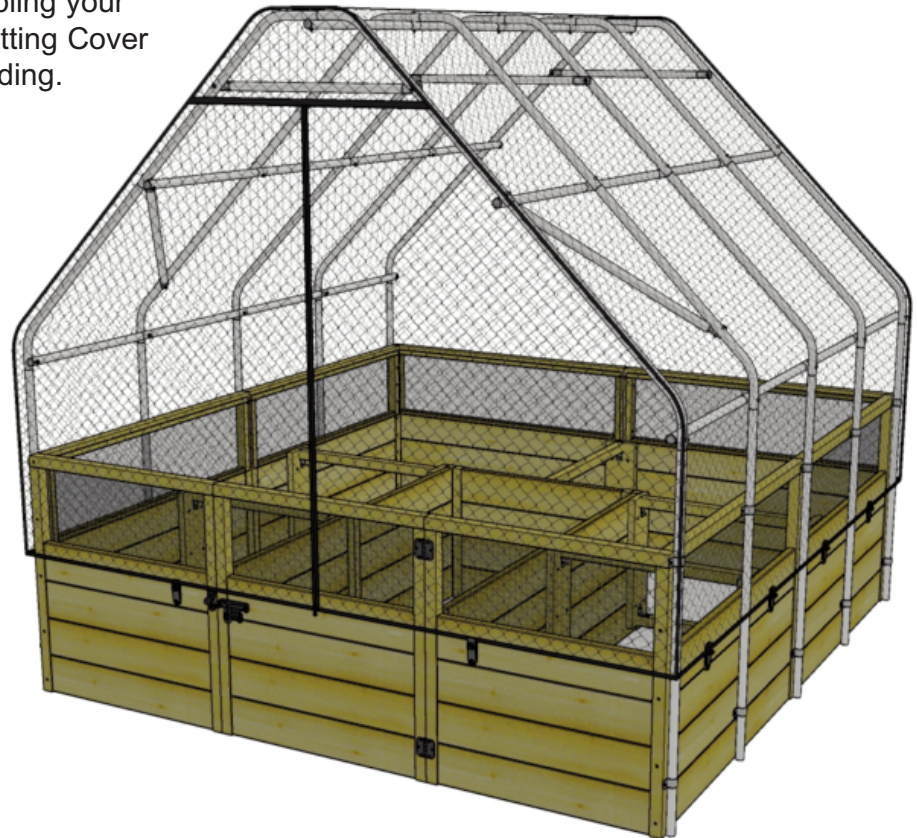

Please call, write or email us at:

Outdoor Living Today

Canadian Address
9393 287th Street
Maple Ridge, British Columbia
Canada V2W 1L1

United States Address
P.O. Box 96
Sumas, Washington
USA 98295



The materials contained in this Assembly Manual may be downloaded or copied provided that ALL copies retain the copyright and any other proprietary notices contained on the materials. No material may be modified, edited or taken out of context such that its use creates a false or misleading statement or impression as to the positions, statements or actions.