



[www.AmishGazebos.com](http://www.AmishGazebos.com)  
1-800-700-1777

# 12 x15 Pavilion-in-a-Box Assembly Instructions

©2023

*PDF and Videos  
available **HERE!***



# Getting Started

Thank you for ordering an Amish Country Pavilion In-A-Box structure! Our hope with your new structure is that you are able to Relax, Connect, and Entertain!

**Please read the entire assembly manual before starting assembly.**

If you have questions regarding the installation of your gazebo kit, please call our **Customer Service Team** at: 1(800)700-1777 ext: 4  
**Hours of operation:** Monday-Friday 9am-5pm EST

Due to the precise fit of many components, we suggest that you stain or paint your pavilion after, rather than before it is assembled.

## Tools Required

Hammer



8' Ladder



Impact Driver



Mallet



Square



Measuring Tape



## Site Prep Recommendations

### Concrete Pylons

1. Dig 16" diameter and 18" deep (or below frost level, whichever is deeper) holes at each post location.
2. Beginning at the grounds highest point, plant 16" Quick-Form tubes making sure the top of each tube is LEVEL with all the rest.
3. Use rebar as needed.
4. Fill each tube with concrete and allow it to cure before assembling your pergola.
5. It is very important that the top of each pylon is LEVEL with all the rest.

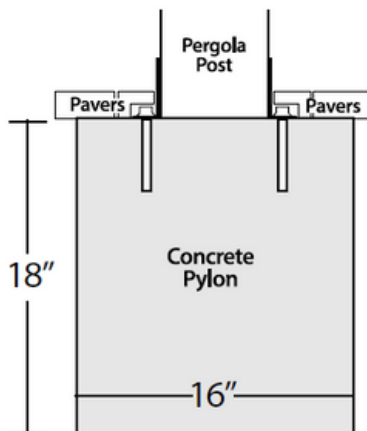

### Concrete Pad

1. Dig out 6"-8" of ground so it is level all throughout its lowest point.
2. Temporarily plant wood forms around the perimeter of your pergola foundation area.

3. Dig a 12"x12" continuous footing around the perimeter of the pad.

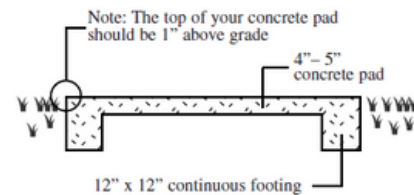

4. Cover the area with 4" of crushed stone.
5. Use rebar as needed.
6. Pour concrete throughout the base.
7. Make sure all the post locations are LEVEL with each other.

# 12x15 Pavilion-in-a-Box Parts List

## Main Beam Parts

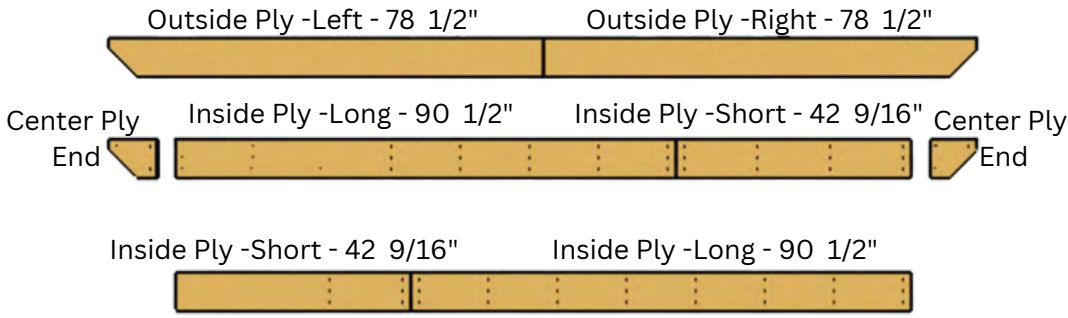

## Hardware Included

- 8 pcs. Stainless Steel Post Brackets
- 8 pcs. 3/8" x 2 1/2" Concrete Anchors
- 90 pcs. 3 1/2" Screws
- 600 pcs. 2 1/2" Screws
- 130 pcs. 2" Screws
- 20 pcs. Roofing Nails
- 2" & 4" Square Driver Bits
- 1/4" Driver Bit for Metal Roofing Screws

## Cross Beam Parts

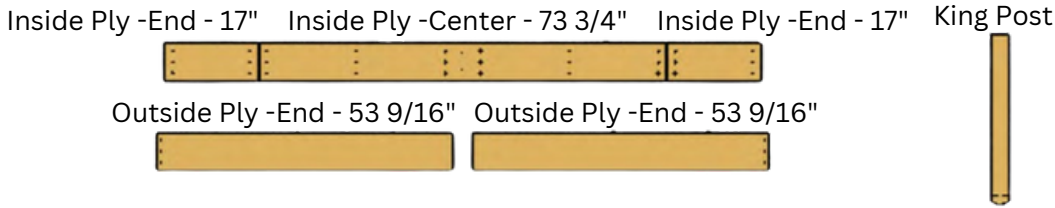

## Post and Trim

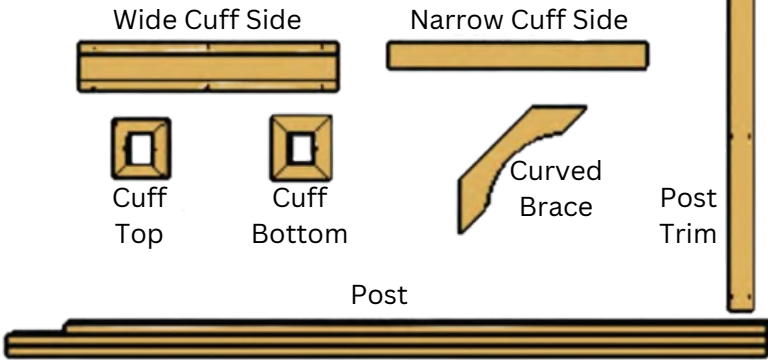

## Roof Parts

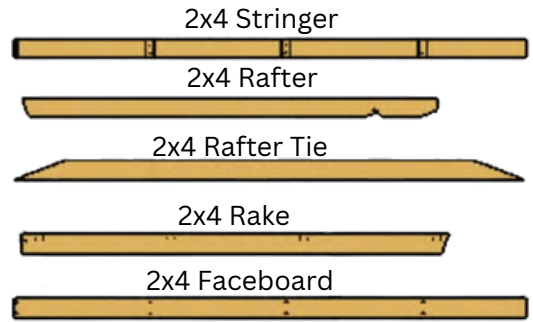

## Metal Roof Parts



Metal Roof Panel



## Post Cuff Assembly

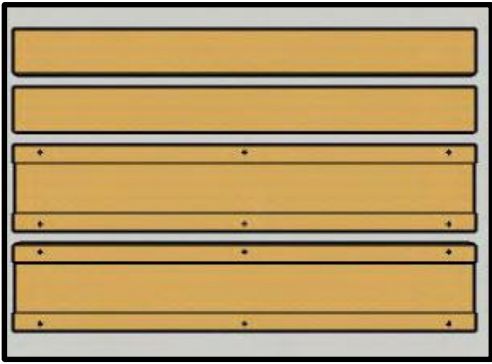

**Step 1:** Locate (2) wide cuff sides and (2) narrow cuff sides.

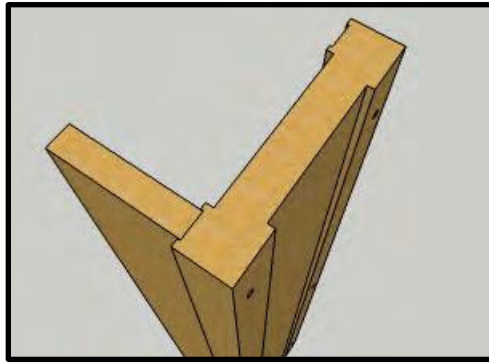

**Step 2:** Place (1) narrow cuff side into the slot in a wide cuff side.

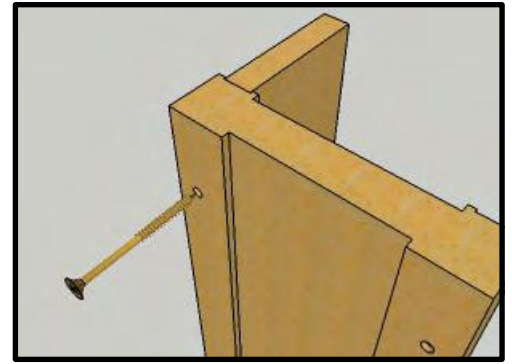

**Step 3:** Align the (2) cuff sides at one end and fasten with (1) 2" screw through a predrilled hole.

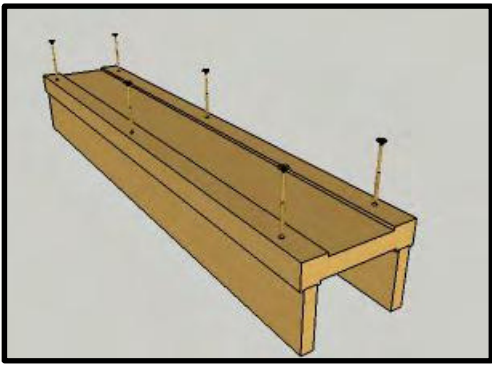

**Step 4:** Place the second narrow cuff side into the other slot in the wide cuff side. Then fasten with (1) 2" screw through each predrilled hole.

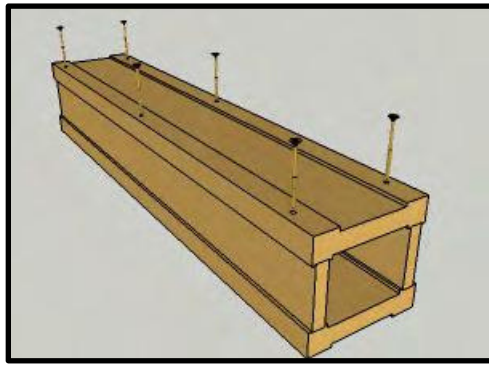

**Step 5:** Now put the second wide cuff side into place as shown and fasten with (1) 2" screw through each predrilled hole.

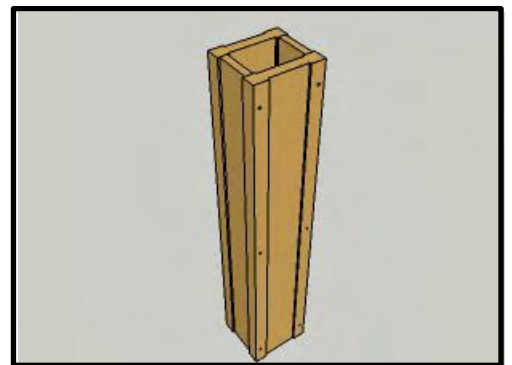

The assembly should now look like this.

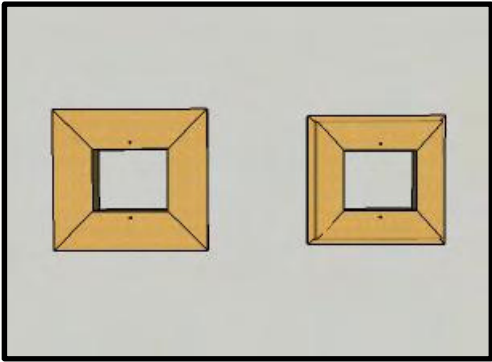

**Step 6:** Locate (1) cuff top and (1) cuff bottom.

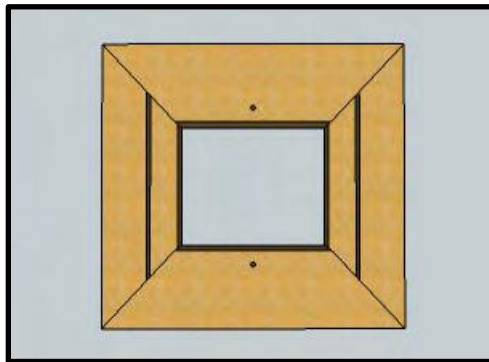

**Notice:** A cuff bottom is smaller and has a notch on the bottom.

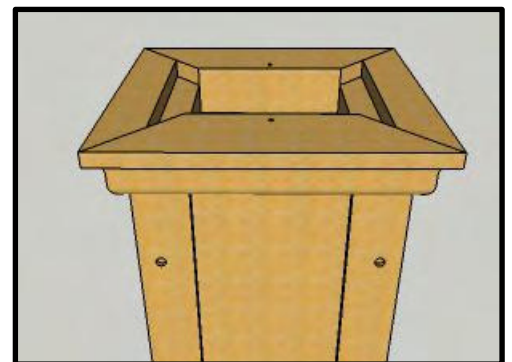

**Step 7:** Place (1) cuff bottom on the cuff sides. The wide part of cuff bottom should face up. Notice that the cuff bottom is not perfectly square but rather rectangular. Place the long sides of cuff bottom along the wide cuff sides.



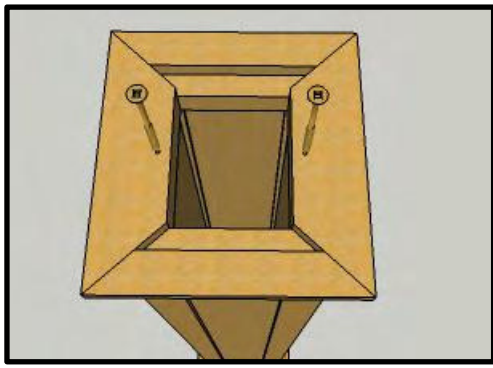

**Step 8:** Make sure the cuff bottom is centered on the cuff sides, then fasten with (1) 2" screw through each predrilled hole.

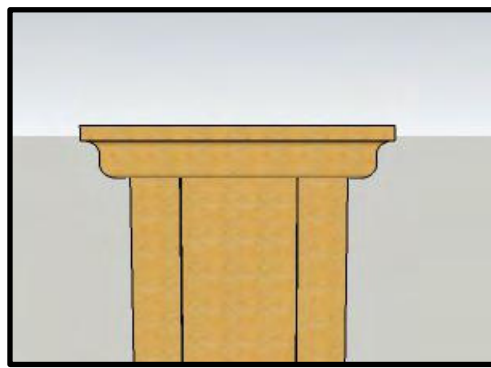

**Step 9:** Turn the cuff assembly around and place a **cuff top** on the other end. Again, the wide part of cuff top should face up. And long side of cuff top should be along wide cuff sides.

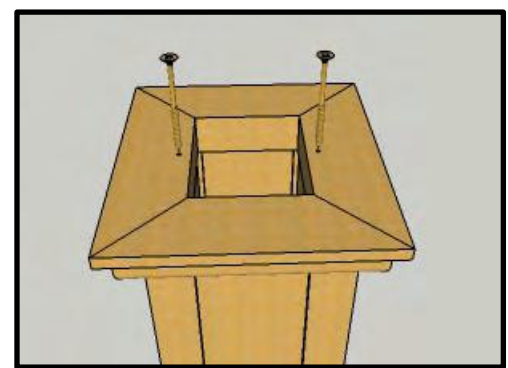

**Step 10:** Make sure cuff top is centered on cuff sides, then fasten with (1) 2" screw through each predrilled hole.

Follow steps 1-10 to assemble the 3 remaining cuffs.

## Beam Assembly

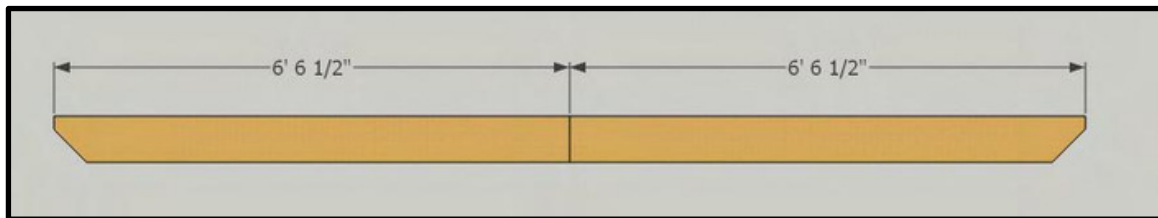

**Step 1:** Start with the **main beam**. Lay out the **outside ply** as shown. The countersink holes should face down.

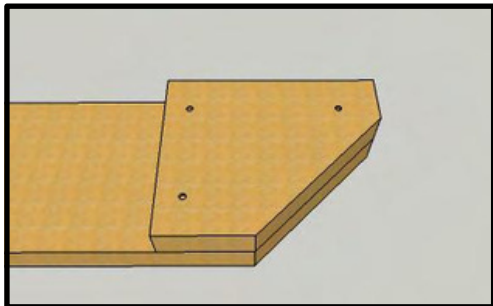

**Step 2:** Place (1) **center ply - end**, on one angled end of the outside ply. Place it so the ends line up.

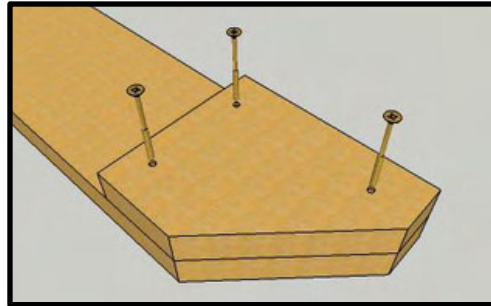

**Step 3:** Fasten the **center ply - end** to the **outside ply** with (1) 2 1/2" screw in each predrilled hole.

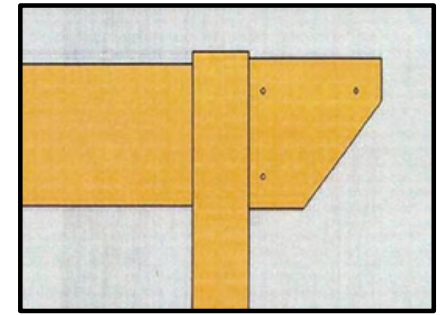

**Step 4:** Place a **post** on the end of beam. The center ply of the post should fit next to the **center ply - end**.

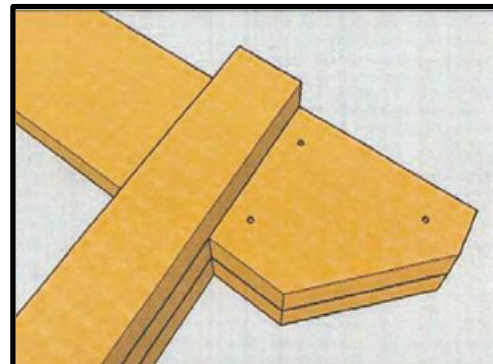

**Step 5:** Be sure the **post** is fit tightly against the **center ply - end**.

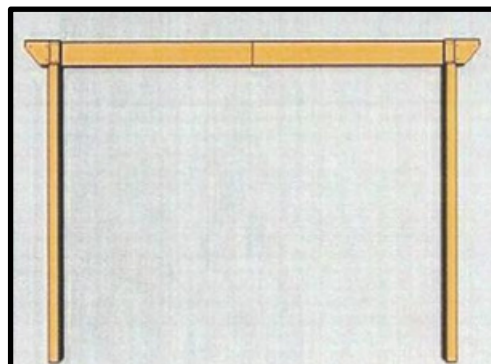

**Step 6:** The beam should look like this.

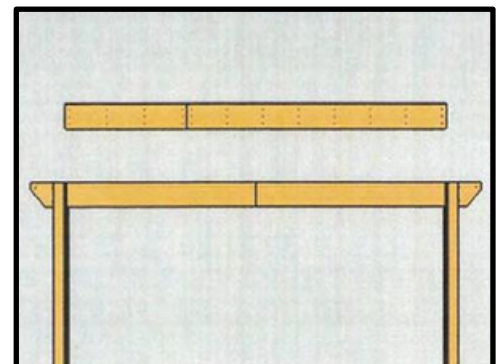

**Step 7:** Find the **inside ply - long** and **inside ply - short**. Lay them out as shown.

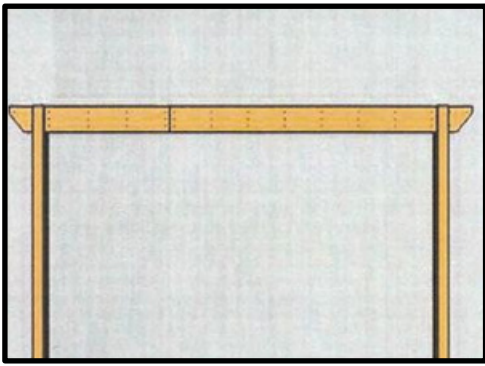

**Step 8:** The **inside ply – long** and **inside ply – short**, should fit on the **outside ply**, between the **posts**.

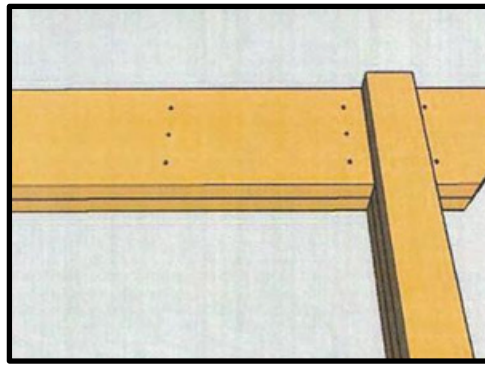

**Step 9:** Be sure each **center ply** is flush on the bottom of the **outside ply**. Then fasten with **2 ½"** screws through the predrilled holes. Make sure each piece draws together tightly.

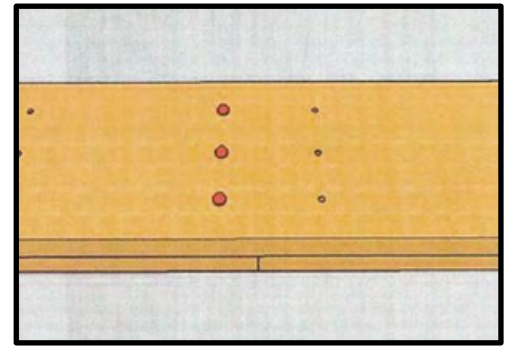

**Step 10:** Drive (3) additional **2 ½"** screws through the **inside ply – long** into the **outside ply**. Place the (3) screws just beside the splice in the **outside ply**, so the ends of each **outside ply** is secured.

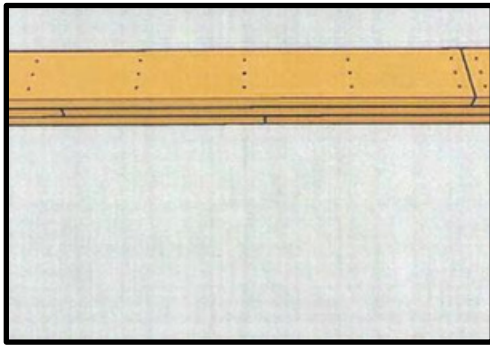

**Step 11:** Place the second **inside ply** on the first **inside ply**. The **inside ply – long** should now be opposite the previous **inside ply – long**. Now fasten the second inside ply with **2 ½"** screws through the predrilled holes.

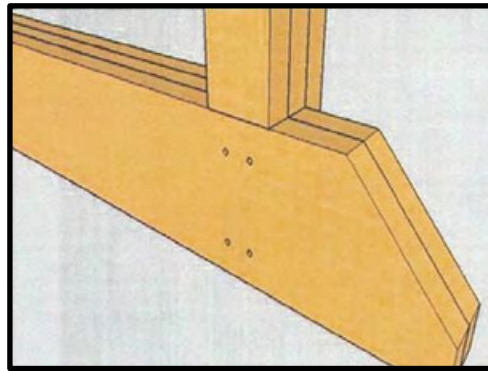

**Step 12:** Now set the beam upright, upside down. Fasten the **posts** with **2 ½"** screws in the predrilled holes in the **outside ply**. Follow the previous 12 steps to assemble the second main beam.

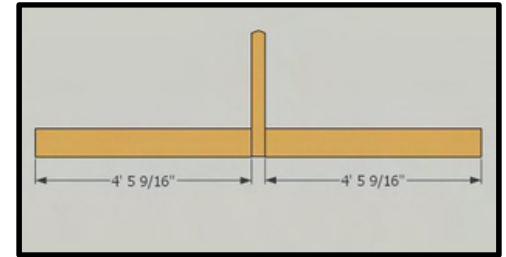

**Step 14:** Now assemble the **cross beams**. Lay out (2) **outside plies** and (1) **king post**. The predrilled holes in the **outside ply** should be away from the **king post** and should face down. The predrilled holes in the **king post** should face up.

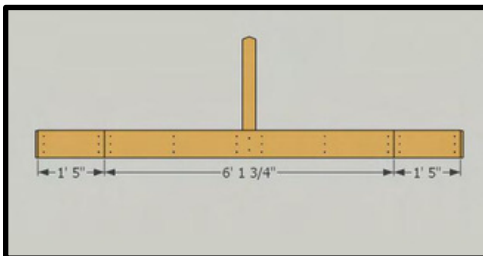

**Step 15:** Lay the **inside ply** on the **outside ply** as shown.

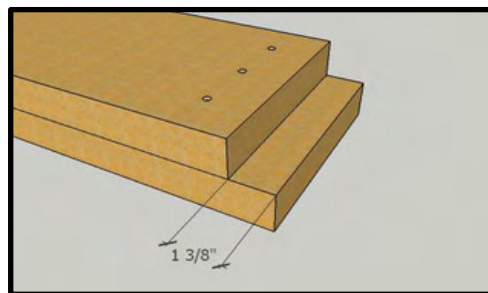

**Step 16:** The ends of the **inside ply** should be **1 3/8"** back from the end of the **outside ply**.

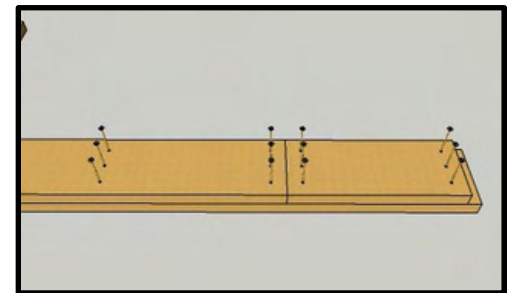

**Step 17:** Be sure each ply is flush on the bottom, then fasten with **2 ½"** screws through each predrilled hole.



# Post and Beam Assembly

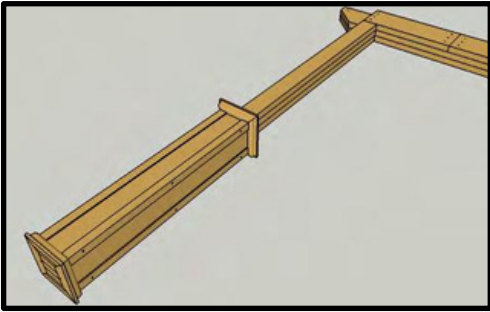

**Step 1:** Slide (1) **post cuff** onto each **post**. Be sure to have the bottom of the post cuff toward the bottom of post.

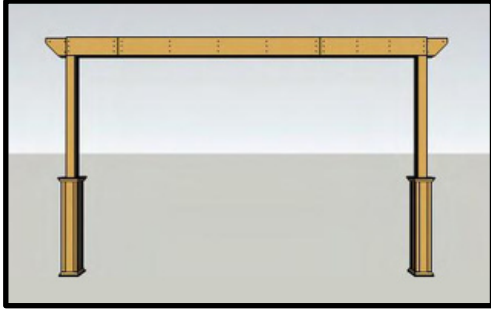

**Step 2:** Now set up one **main beam** and set it in place. **Note:** do not leave this beam unattended without first bracing it so it will not fall.

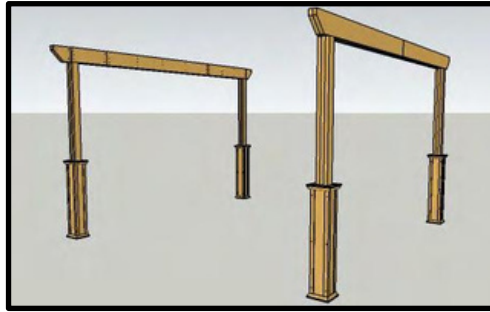

**Step 3:** Set up the second **main beam** opposite the first. Be sure to have the **inside ply** of the beams facing each other.

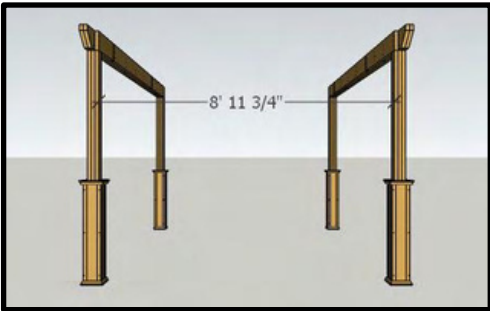

**Step 4:** Measure and adjust as needed so the measurement between **posts** is **8' 11 3/4"**. Brace the beams or have someone hold each beam so it won't fall.

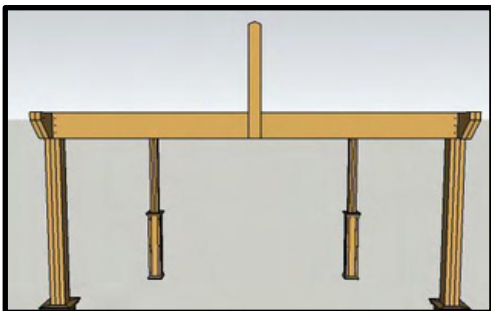

**Step 5:** Lift a **cross beam** in place. The **outside ply** of the **cross beam** should overlap the **inside ply** of the **post**.

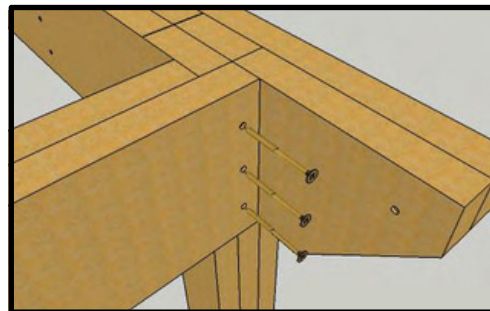

**Step 6:** Be sure to line up each beam at the bottom, then fasten with **2 1/2"** screws in each predrilled hole at each end.

# Post Anchoring

After each beam has been installed, you are ready to anchor the posts.

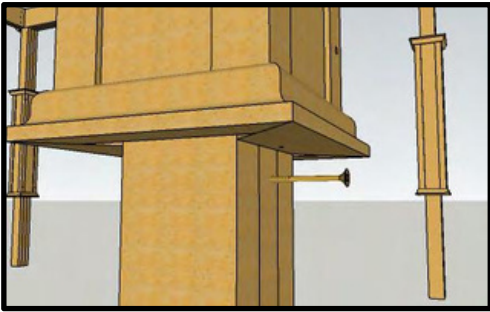

**Step 1:** You will need to lift the **post cuffs**. We suggest holding them up by driving a screw halfway into the post about **2'** up from the bottom.

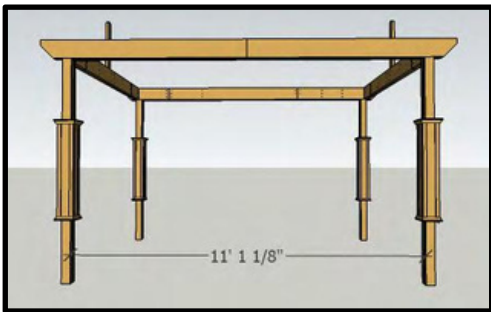

**Step 2:** Measure **between** posts at the **bottom** along the **long side**. Adjust the bottom of the posts as needed to make sure there is **11' 1 1/8"** **between bottom of posts**.

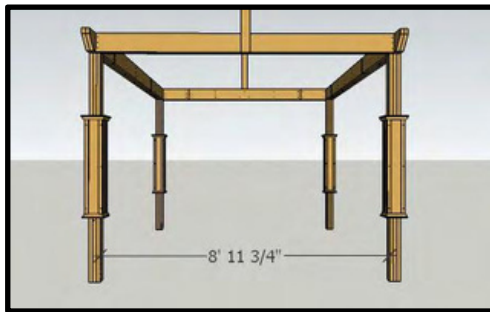

**Step 3:** Measure **between** posts at the **bottom** along the **short side**. Adjust the bottom of the posts as needed to make sure there is **8' 11 3/4"** **between bottom of posts**.

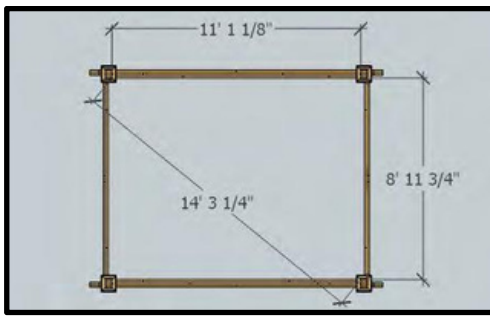

**Step 4:** Also measure between post across corner both ways at the bottom to make sure posts are squared off.

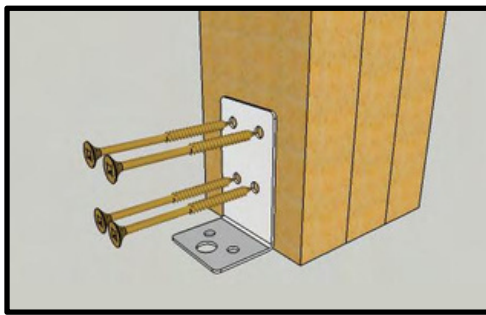

**Step 5:** After all the **posts** are in the correct location, place a **post anchor bracket** on the side of the post as shown. **Do not put the bracket on the laminated side of the posts.** Fasten with (4) **2 1/2"** tan screws. Install (2) **brackets** on each post.

Now anchor the posts to your foundation. If anchoring to concrete, drill 3/8" holes and use the provided **3/8" x 2 1/2" concrete anchors**. If anchoring to a wood or composite surface, then contact a local retailer about the best way to anchor your pavilion to your mounting surface.

## Post Trim and Braces

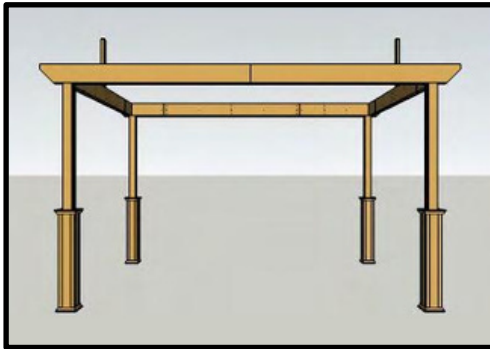

**Step 1:** After the **posts** have been anchored, you may now remove the **screws** that held the **post cuffs** off the ground. Slide the **post cuffs** down in place.

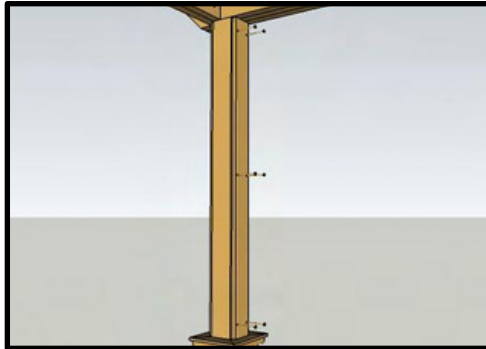

**Step 2:** Install a **post trim** on the laminated sides of each **post**. Center the **post trim** on the **post** and fasten with **2"** screws in the predrilled holes.

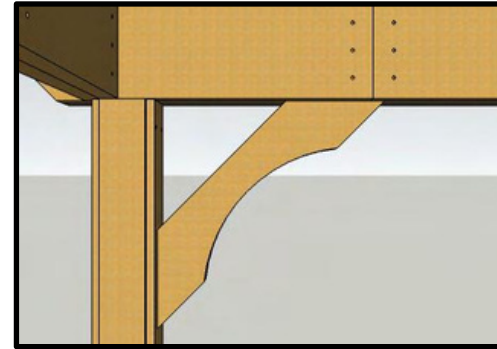

**Step 3:** To install the **curved braces**, hold the **brace** in place. Then have someone push the top of the **post** to the left or right as needed so the **brace** fits perfectly.

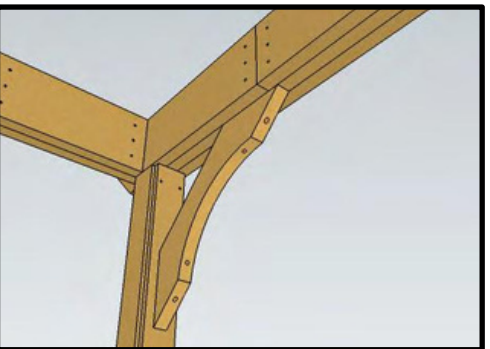

**Step 4:** To install the **braces** on the long side, place the **brace** on the **center ply** of the **main beam** at the top, and centered on the **post** on the bottom.

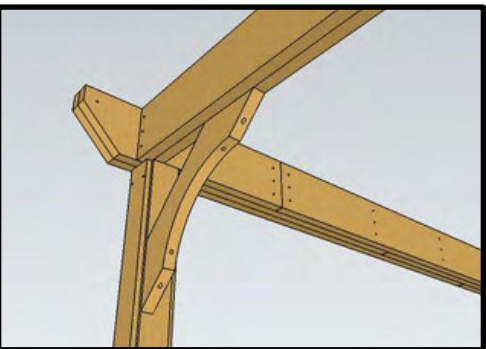

**Step 5:** To install the **brace** on the short side, place the **brace** on the **inside ply** of the **cross beam** at the top and flush with the **outside edge** of the **post** at the bottom. Then fasten with **3 1/2"** screws in each predrilled hole.

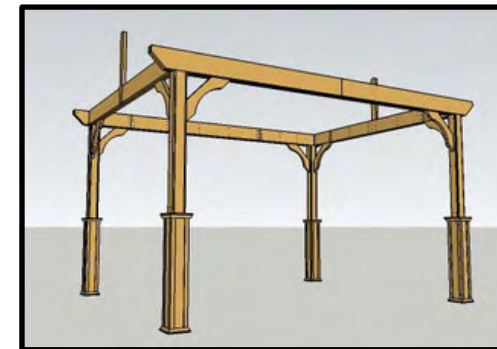

**Step 6:** Install (2) **curved braces** on each **post**.



## Rafter Assembly

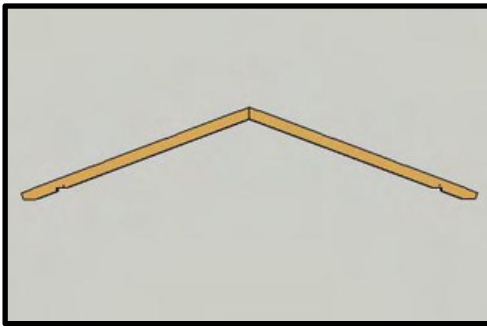

**Step 1:** Lay out (2) **2x4 rafters** as shown. Line up the **rafters** at the point.

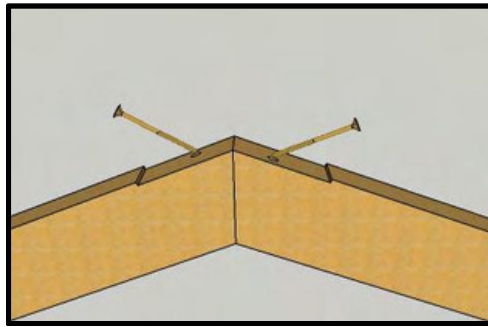

**Step 2:** Fasten the (2) **rafters** with **2 1/2"** screws through the predrilled holes.

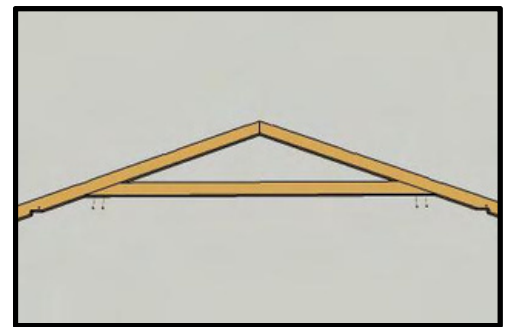

**Step 3:** Place (1) **2x4 rafter tie** in position as shown. Place it evenly between the marks on the **rafters**. (If there are no marks, measure **48 1/16"** from the top of the **rafter tie**.) Then fasten the **rafter tie** to the **rafters** with **3 1/2"** screws in the predrilled holes.

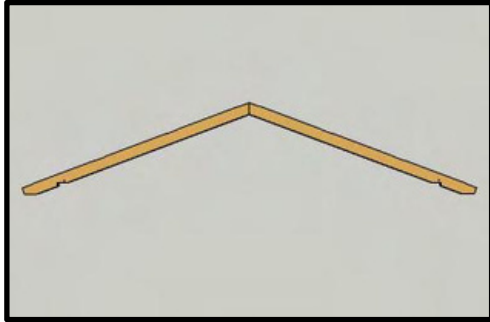

**Step 4:** Assemble the remaining **rafters**. The last (2) **rafters** will not have a **rafter tie**.

## Preparing for Rafters

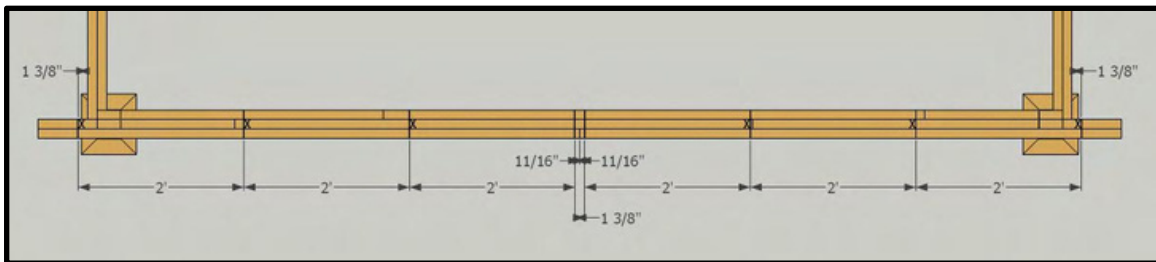

**Step 1:** Start at the **center** of the **main beam** on top. Measure and mark **11/16"** from the **center** both ways. The 2 marks should then be **1 3/8"** apart.

**Step 2:** Measure every **2'** from the first **2 marks** as shown. Then mark an **"X"** beside each mark toward the **center** of the **beam** as shown. This will show you where to place the **rafters**.

## Rafters and Stringers

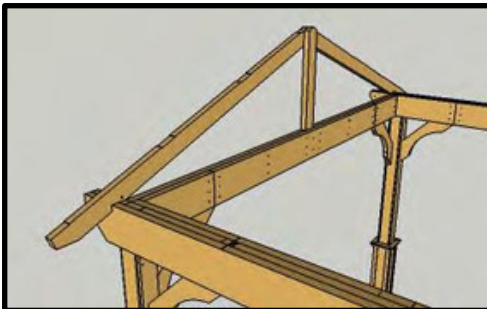

**Step 1:** Begin by installing the (2) **rafters** with no **rafter tie**, on each end of the **main beams** as shown. The **inside edge** of the **rafter** should be flush with the **outside edge** of the **cross beam**.

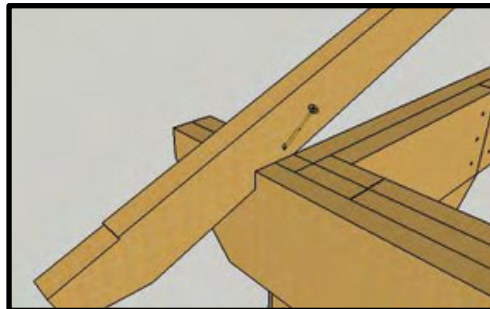

**Step 2:** Fasten each end of each **rafter** to the **main beam** with **3 1/2"** screws through the predrilled holes.

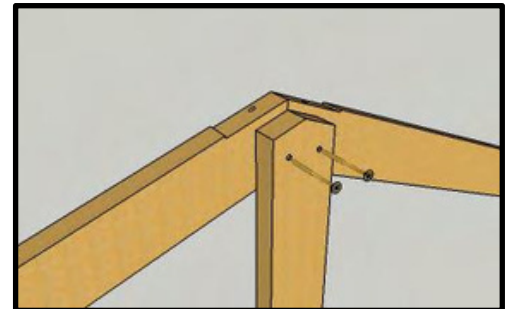

**Step 3:** The top of the **rafter** should be about **3/4" - 1/2"** higher than the top of the **king post**. Fasten the top of the **rafters** to the **king post** with **2 1/2"** screws in each predrilled hole.

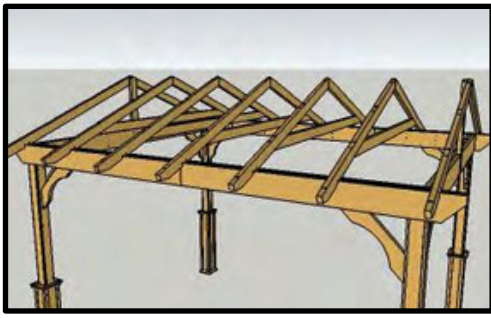

**Step 4:** Install the remaining **rafters**. Place each **rafter** on the **marks** on the **main beam** and fasten with **3 ½"** screws. **Note:** **All the rafters should measure 24"** from center to center of rafters.

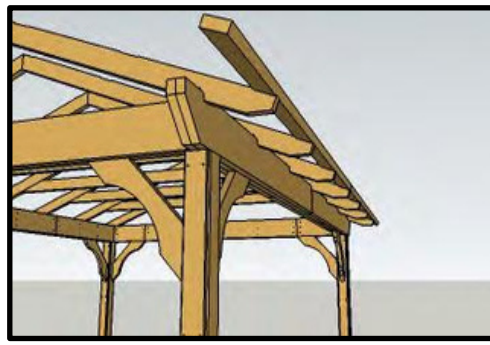

**Step 5:** Install the **2x4 stringers** on the **rafters**. The **rafters** and **stringers** are notched to fit together. Keep the first row of **stringers** flush with the ends of the **rafters**.

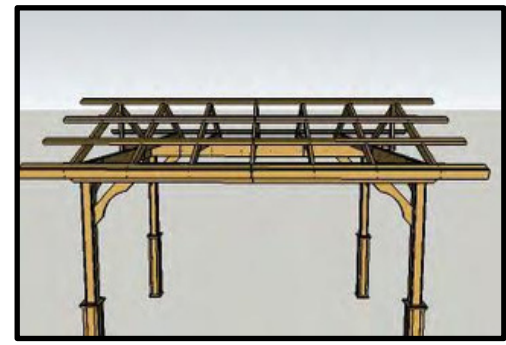

**Step 6:** Install the **stringers** in the notches in the **rafters**, making sure the **rafters** are fit into the notches in the **stringers**. Fasten with **2 ½"** screws in the predrilled holes.

## Faceboard and Rake

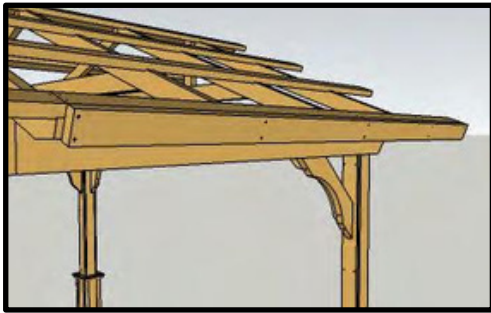

**Step 1:** Install the **faceboards**. The end of the **faceboard** with (2) predrilled holes should be in the center.

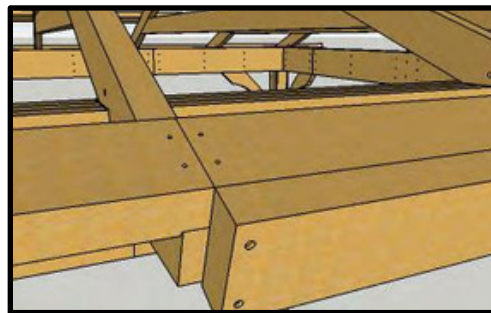

**Step 2:** Line up the **faceboard** with the center of the center **rafter** and flush with the top of the **stringer**. Fasten with **2 ½"** screws in the predrilled holes.

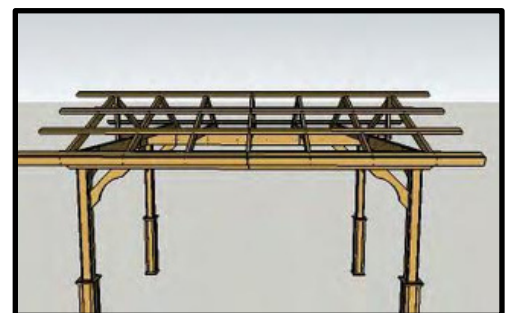

**Step 3:** Install the remaining **faceboards**. Keep each **faceboard** flush with the top of the **stringers**.

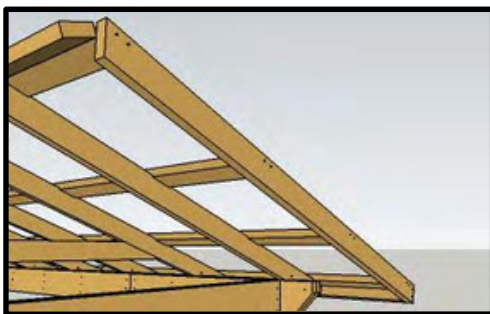

**Step 4:** Install the **rake**. Place the **rake** on the ends of the **stringers** and **faceboard**. Place the angled cut up at the top of the roof.

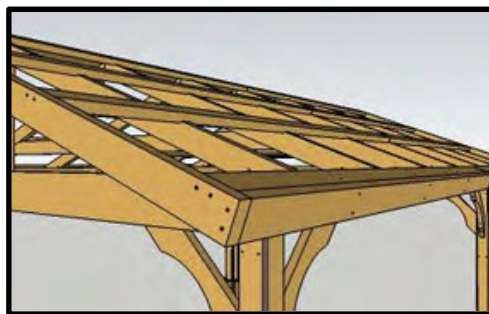

**Step 5:** Keep the straight cut end flush with the **faceboard**, and the top of the **rake** flush with the top of the **stringers**. Fasten to the **faceboard** and **stringers** with **2 ½"** screws.

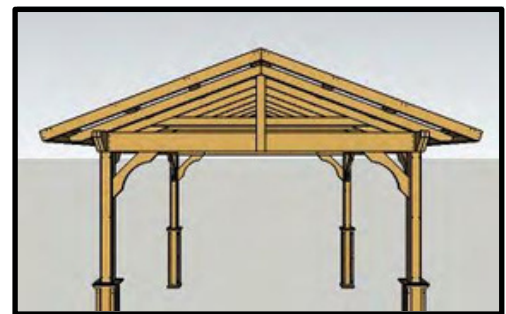

**Step 6:** Install the remaining **rake**. Line up the **rake** at the peak.



## Gutter Apron

**Warning:** Metal roofing and trim has very sharp edges. Always wear gloves when handling metal roofing or trim.

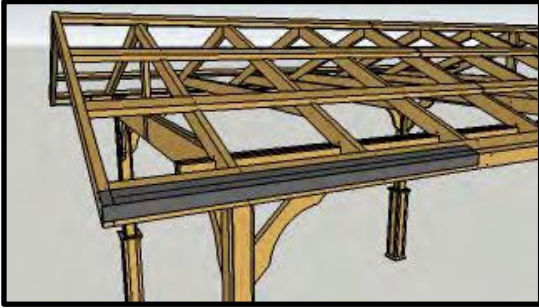

**Step 1:** Install the **gutter apron**, place in position as shown. It should be flush with the outside edge of the **rake**, with the 3" side on top and the 2" side on the bottom. Fasten the **gutter apron** to the **stringer** with (3) **roofing nails**.

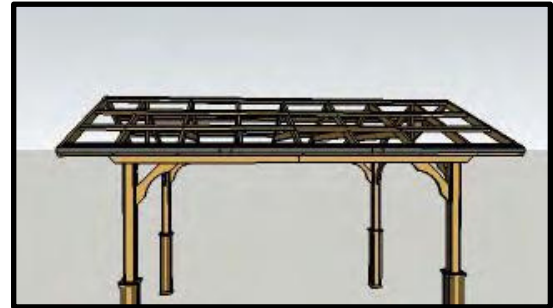

**Step 2:** Install (2) more pieces of **gutter apron** on the same side. The gutter apron should be flush with the outside edge of the **rake** at each end, and the **gutter apron** in the center should overlap the other two about 4". Fasten each **gutter apron** with (3) **roofing nails**.

## Metal Roof Panels

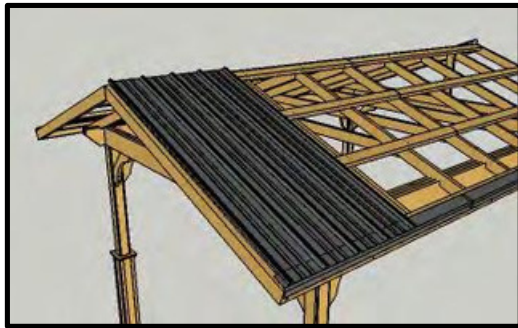

**Step 3:** Place the first **metal roof panel** in place. Notice that the one side of each panel will have a small lip (see above right) and the other side does not (see upper middle). Place the side **without** the lip flush along the outside edge of the **rake**. Be sure it does not extend out past the **2x4 rake**.

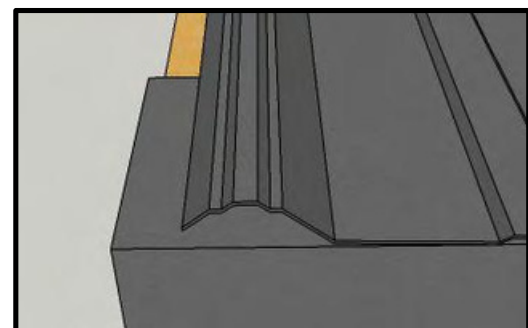
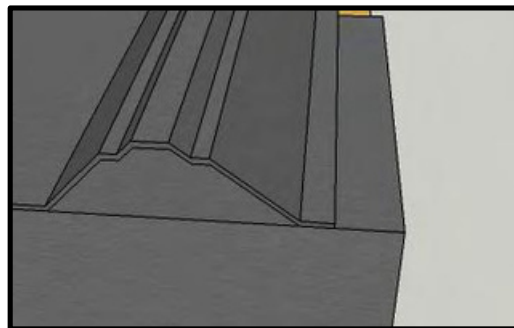

**Step 4:** With the edge of the **metal roof panel** about flush with the outside edge of the **rake**, be sure the bottom edge of the panel is flush with the bend in the **gutter apron**.



**Step 5:** Fasten the **metal roof panel** with **1" metal roof screws**. Fasten along the bottom with a screw on both sides of each rib as shown. Keep the screws about **2"** from the bottom edge.



**Step 6:** Also fasten the **metal roof panel** with **1" metal roof screws** into each of the remaining **stringers**. If the lip is on the right side of the metal roof panel, then fasten on the right side of each rib, or vice versa.



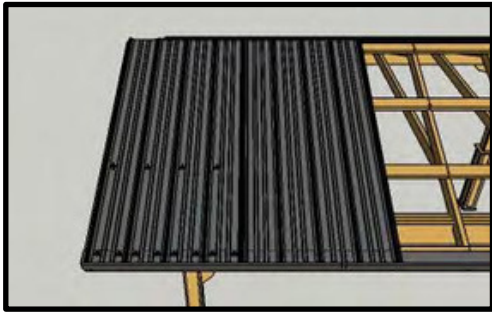

**Step 7:** Now place the second **metal roof panel** in place beside the first panel.

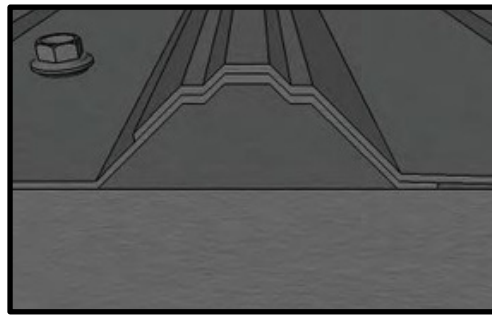

**Step 8:** Be sure the side of the second panel **without the lip** is **overlapping** the side of the first panel **with a lip**.

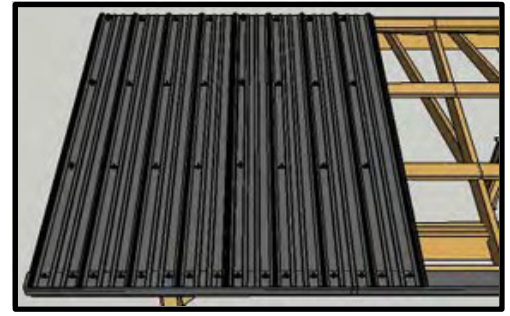

**Step 9:** Keep the second panel flush on the bottom and fasten in the same way as the first panel. Follow the previous steps to install the remaining metal roof panels.

## Metal Rake

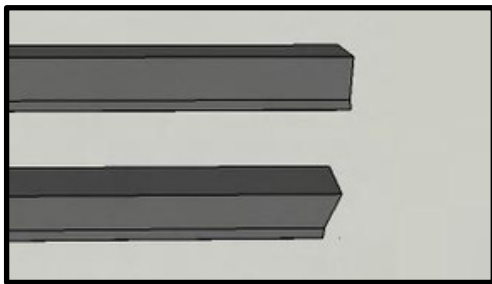

**Step 1:** (2) of the **metal rakes** will have an angled cut on the one end. Choose (1) with an angled cut and (1) without.



**Step 2:** First take the **metal rake** with an angled cut. Put the rake in place with the **angled cut** at the **roof peak**. The **straight cut** end should be at the **bottom edge** of roof.



**Step 3:** With the **metal rake** flush with the **metal roof panel** at the bottom, fasten with (1) **1" metal roofing screw** in the location shown, about **2"** from the bottom.

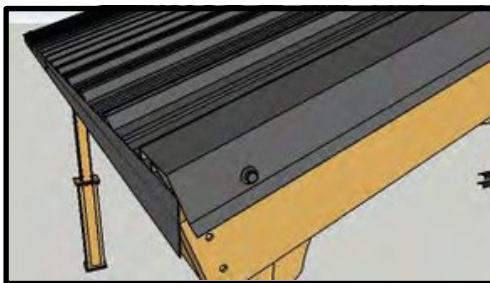

**Step 4:** Also fasten the **metal rake** with (1) **1" metal roofing screw** into the **2x4 rake** as shown.



**Step 5:** Now put the **metal rake**, **without the angled cut**, in place on the opposite side. Slide it **under the angled cut** at the **roof peak**. Also make sure it is flush at the bottom.



**Step 6:** Fasten both **metal rake** with **1" metal roofing screws**. Fasten with (1) screw into each **stringer** and (4) screws into the **2x4 rake**. Also, install the **metal rake** at the opposite end of pavilion.

# Ridge Cap



**Step 1:** Place (1) **ridge cap** on the roof peak. Place the **end** of the **ridge cap** flush with the **outside edge** of the **metal rake**.



**Step 2:** Fasten the **ridge cap** with **2" metal roofing screws** into each **rib** of the **metal roofing panels**.



**Step 3:** Install the second **ridge cap** at the opposite end of pavilion. Be sure the end of the **ridge cap** is flush with the **outside edge** of the **metal rake**.

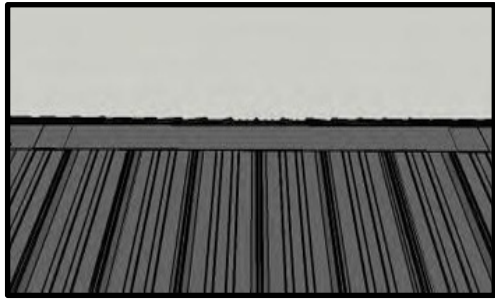

**Step 4:** Install the final **ridge cap** on the center of the roof peak. It should overlap the first two **ridge caps** about **4"**. Fasten with **2" metal roofing screws** into each **rib** of the **metal roof panels**.

## Your Pavilion-In-A-Box Is Now Complete!

