

“EZ UP” ALIGNMENT HINGE



This swing set features the KidKraft “EZ UP” alignment hinge for quick and easy fort frame assembly in Step 2 - 7.

The living hinge is not required for swing set structural integrity.

Complete the swing set build by following the instruction manual steps, guidelines, and all other proper maintenance and care to achieve a safe and quality product.



F29535

TIMBERLAKE PLAYSET



OBSTACLE FREE SAFETY ZONE - 30'-2" L x 26'-5" D x 15'-7" H (9.11m x 8.05m x 4.75m) area requires Protective Surfacing. See page 4.

MAXIMUM VERTICAL FALL HEIGHT - 6'-4" (1.93m).

CAPACITY - 9 Users Maximum, Ages 3 - 10; Weight Limit 110 lbs. (49.9 kg) per child.

RESIDENTIAL HOME USE ONLY. Not intended for public areas such as multi-unit residences, schools, churches, nurseries, day cares or parks.

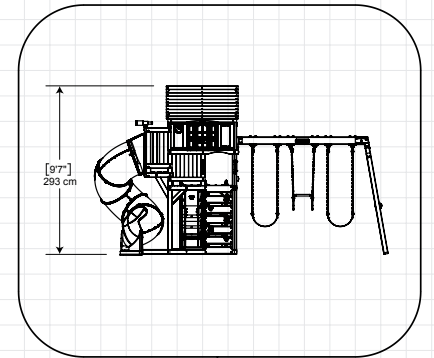
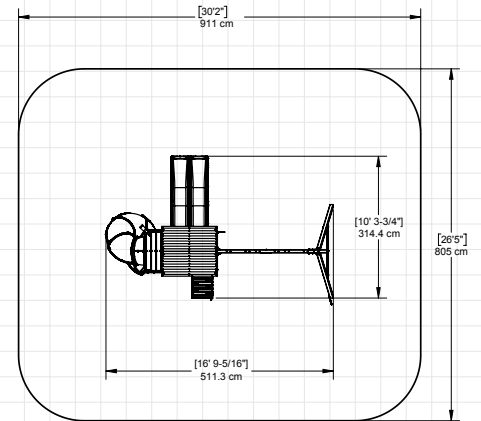

INSTALLATION AND OPERATING INSTRUCTIONS

FOR 24/7 ONLINE PARTS REPLACEMENT

parts.kidkraft.com

KidKraft, Inc.
4630 Olin Road
Dallas, Texas 75244
USA

customerservice@kidkraft.com

1.800.933.0771
972.385.0100

parts.kidkraft.eu

KidKraft Netherlands BV
Olympisch Stadion 8
1076 DE Amsterdam
The Netherlands

europcustomerservice@kidkraft.com

+31 20 305 8620
M-F from 09:00 to 17:30 (GMT+1)

9409535

Rev 07/25/2022



⚠ WARNING

To reduce the risk of serious injury or death, please read and follow these instructions. Keep and refer to instructions as needed and pass along to any future owners of this item.

Congratulations on purchasing a KidKraft product!

**Our items are made of high-quality,
durable Cunninghamia Lanceolata wood
from the cypress family.**

**Lumber from these trees are known for
their light weight and excellent strength.
The porosity of this wood allows the
moisture to absorb and evaporate in the
fibers, resisting rot and bugs.**

**Engineered for great play, our products
also go through extensive testing for safety.**

**Plus, our team has developed a series of
proprietary methods for a simpler, more
organized assembly. Less build time and
more play time is our motto!**

**However, during assembly if you have any
questions or concerns, please reach out.
Our Customer Service can help with missing
parts, instructions or maintenance.**

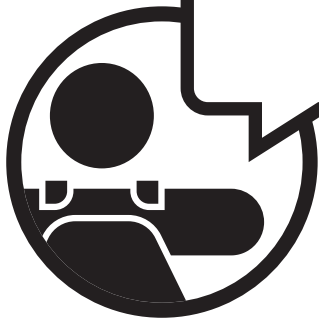

Warnings and Safe Play Instructions



CONTINUOUS ADULT SUPERVISION REQUIRED. Most serious injuries and deaths on playground equipment have occurred while children were unsupervised! Our products are designed to meet mandatory and voluntary safety standards. Complying with all warnings and recommendations in these instructions will reduce the risk of serious or fatal injury to children using this play system. Go over the warnings and safe play instructions regularly with your children and make certain that they understand and follow them. Remember on-site adult supervision is required for children of all ages.



WARNING

SERIOUS HEAD INJURY HAZARD

Installation over concrete, asphalt, dirt, grass, carpet and other hard surface creates a risk of serious injury or death from falls to the ground. Install and maintain shock absorbing material under and around play-set as recommended on page 3 of these instructions.

COLLISION HAZARD

Place play-set on level ground at least 2m from any obstruction such as a garage or house, fences, poles, trees, sidewalks, walls, landscape timbers, rocks, pavement, planters, garden borders, overhanging branches, laundry lines, and electrical wires. (See OBSTACLE FREE SAFETY ZONE on cover)

CHOKING HAZARD/SHARP EDGES & POINTS

Adult assembly required. This product contains small parts and parts with sharp edges and points. Keep parts away from children until fully assembled.

WARNING LABEL

Owners shall be responsible for maintaining the legibility of the warning labels.

STRANGULATION HAZARD

- NEVER allow children to play with ropes, clotheslines, pet leashes, cables, chains or cord-like items when using this play-set or to attach these items to play-set.
- NEVER allow children to wear loose fitting clothing, ponchos, hoods, scarves, capes, necklaces, items with draw-strings, cords or ties when using this play-set.
- NEVER allow children to wear bike or sport helmets when using this play-set.

Failure to prohibit these items, even helmets with chin straps, increases the risk of serious injury and death to children from entanglement and strangulation.

TIP OVER HAZARD

Choose a level location for the equipment. This can reduce the likelihood of the play set tipping over and loose-fill surfacing materials washing away during heavy rains.

DO NOT allow children to play on the play-set until the assembly is complete and the unit is properly anchored.

Never add extra length to chain or rope. The chains or ropes provided are the maximum length designed for the swinging element(s).



WARNING – Safe Play Instructions

- ✓ Observe capacity limitations of your play-set. See front cover.
- ✓ Dress children with well fitting and full foot enclosing footwear.
- ✓ Teach children to sit with their full weight in the center of the swing seat to prevent erratic swing motion or falling off.
- ✓ Check for splintered, broken or cracked wood; missing, loose, or sharp edged hardware. Replace, tighten and or sand smooth as required prior to playing.
- ✓ Verify that suspended climbing ropes, rope ladders, chain or cable are secured at both ends and cannot be looped back on itself as to create an entanglement hazard.
- ✓ On sunny and or hot days, check the slide and other plastic rides to assure that they are not very hot as to cause burns. Cool hot slide and rides with water and wipe dry prior to using.
- ✓ Orientate slide such that it gets the least amount of exposure to the sun.
- ✗ Do not allow children to wear open toe or heel footwear like sandals, flip-flops or clogs.
- ✗ Do not allow children to walk, in front, between, behind or close to moving rides.
- ✗ Do not let children twist swing chains or ropes or loop them over the top support bar. This may reduce the strength of the chain or rope and cause premature failure.
- ✗ Do not let children get off rides while they are in motion.
- ✗ Do not permit climbing on equipment when it is wet.
- ✗ Do not permit rough play or use of equipment in a manner for which it was not intended. Standing on or jumping from the roof, elevated platforms, swings, climbers, ladders or slide can be dangerous.
- ✗ Do not allow children to swing empty rides or seats.
- ✗ Do not allow children to go down slide head first or run up slide.



! Protective Surfacing - Reducing Risk of Serious Head Injury From Falls

One of the most important things you can do to reduce the likelihood of serious head injuries is to install shock-absorbing protective surfacing under and around your play equipment. The protective surfacing should be applied to a depth that is suitable for the equipment height in accordance with ASTM F1292. There are different types of surfacing to choose from; whichever product you select, follow these guidelines:

Loose-Fill Materials

- Maintain a minimum depth of 9 inches (23 cm) of loose-fill materials such as wood mulch/chips, engineered wood fiber (EWF), or shredded/recycled rubber mulch for equipment up to 8 feet (2.45 m) high; and 9 inches (23 cm) of sand or pea gravel for equipment up to 5 feet (1.5 m) high. NOTE: An initial fill level of 12 inches (31 cm) will compress to about a 9-inch (23 cm) depth of surfacing over time. The surfacing will also compact, displace, and settle, and should be periodically raked and refilled to maintain at least a 9-inch (23 cm) depth.
- Use a minimum of 6 inches (16 cm) of protective surfacing for play equipment less than 4 feet (1.22 m) in height. If maintained properly, this should be adequate. (At depths less than 6 inches (16 cm), the protective material is too easily displaced or compacted.)

NOTE: Do not install home playground equipment over concrete, asphalt, or any other hard surface. A fall onto a hard surface can result in serious injury to the equipment user. Grass and dirt are not considered protective surfacing because wear and environmental factors can reduce their shock absorbing effectiveness. Carpeting and thin mats are not adequate protective surfacing. Ground level equipment -- such as a sandbox, activity wall, playhouse or other equipment that has no elevated play surface -- does not need any protective surfacing.

- Use containment, such as digging out around the perimeter and/or lining the perimeter with landscape edging. Don't forget to account for water drainage.
- Periodically rake, check and maintain the depth of the loose-fill surfacing material. Marking the correct depth on the play equipment support posts will help you to see when the material has settled and needs to be raked and or replenished. Be sure to rake and evenly redistribute the surfacing in heavily used areas.
- Do not install loose fill surfacing over hard surfaces such as concrete or asphalt.

Poured-In-Place Surfaces or Pre-Manufactured Rubber Tiles

You may be interested in using surfacing other than loose-fill materials - like rubber tiles or poured-in-place surfaces.

- Installations of these surfaces generally require a professional and are not "do-it yourself" projects.
- Review surface specifications before purchasing this type of surfacing. Ask the installer/manufacturer for a report showing that the product has been tested to the following safety standard: ASTM F1292 *Standard Specification for Impact Attenuation of Surfacing Materials within the Use Zone of Playground Equipment*. This report should show the specific height for which the surface is intended to protect against serious head injury. This height should be equal to or greater than the fall height - vertical distance between a designated play surface (*elevated surface for standing, sitting, or climbing*) and the protective surfacing below - of your play equipment.
- Check the protective surfacing frequently for wear.

Placement

Proper placement and maintenance of protective surfacing is essential. Refer to diagram on front cover. Be sure to;

- Extend surfacing at least 6 feet (1.8 m) from the equipment in all directions.
- For to-fro swings, extend protective surfacing in front of and behind the swing to a distance equal to twice the height of the top bar from which the swing is suspended.
- For tire swings, extend surfacing in a circle whose radius is equal to the height of the suspending chain or rope, plus 6 feet (1.8 m) in all directions.

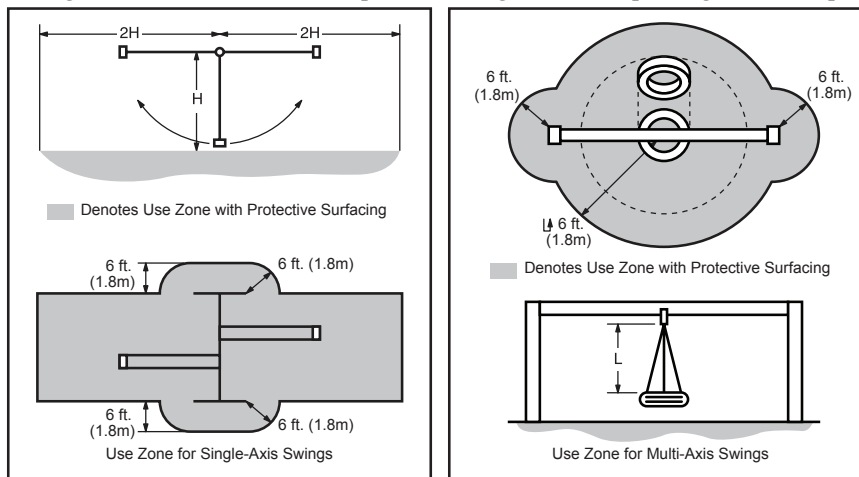

From the CPSC Outdoor Home Playground Safety Handbook. At <http://www.playgroundregs.com/resources/CPSC%20324.pdf>

Instructions for Proper Maintenance

Your KidKraft Play System is designed and constructed of quality materials with your child's safety in mind. As with all outdoor products used by children, it will weather and wear. To maximize the enjoyment, safety and life of your Play Set, it is important that you, the owner, properly maintain it.

Check the following at the beginning of the play season:

HARDWARE:

- ✓ Check metal parts for rust. If found, sand and repaint using a non-lead paint complying with 16 CFR 1303.
- ✓ Inspect and tighten all hardware. On wood assemblies **DO NOT OVER-TIGHTEN** as to cause crushing and splintering of wood.
- ✓ Check for sharp edges or protruding screw threads, add washers if required.

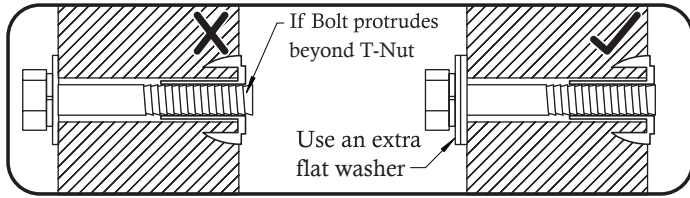
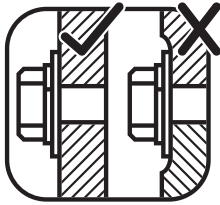

SHOCK ABSORBING SURFACING:

- ✓ Check for foreign objects. Rake and check depth of loose fill protective surfacing materials to prevent compaction and maintain appropriate depth. Replace as necessary. (See Protective Surfacing, page 3)

GROUND STAKES (ANCHORS):

- ✓ Check for looseness, damage or deterioration. Should firmly anchor unit to ground during use. Re-secure and or replace, if necessary.

SWING HANGERS:

- ✓ Check that bolts are secure and tight. Quick clips should be completely closed and threaded clips screwed tight.
- ✓ If squeaking occurs lubricate bushings with oil or WD-40®.

SWINGS, ROPES AND RIDES:

- ✓ Reinstall if removed during cold season. Check all moving parts including swing seats, ropes, chains and attachments for wear, rust and other deterioration. Replace as needed.
- ✓ Check that ropes are tight, secure at both ends and cannot loop back as to create an entrapment.

WOOD PARTS:

- ✓ Check all wood members for deterioration, structural damage and splintering. Sand down splinters and replace deteriorated wood members. As with all wood, some checking and small cracks in grain is normal.
- ✓ Applying a water repellent or stain (water-based) on a yearly basis is important maintenance to maintain maximum life and performance of the product.

Check twice a month during play season:

HARDWARE:

- ✓ Inspect for tightness. Must be firmly against, but not crushing the wood. **DO NOT OVER-TIGHTEN.** This will cause splintering of wood.
- ✓ Check for sharp edges or protruding screw threads. Add washers if required.

SHOCK ABSORBING SURFACING:

- ✓ Rake and check depth of loose fill protective surfacing materials to prevent compaction and maintain appropriate depth. Replace as necessary. (See Protective Surfacing, page 3)

Check once a month during play season:

SWING HANGERS:

- ✓ Check that they are secure and orientated correctly. Hook should rotate freely and perpendicular to support beam.
- ✓ If squeaking occurs lubricate bushings with oil or WD-40®.

SWINGS AND RIDES:

- ✓ Check swing seats, all ropes, chains and attachments for fraying, wear, excessive corrosion or damage. Replace if structurally damaged or deteriorated.

Check at the end of the play season:

SWINGS AND RIDES:

- ✓ To prolong their life, remove swings and store inside when outside temperature is below 32°F/0°C. Below freezing, plastic parts may become more brittle.

SHOCK ABSORBING SURFACING:

- ✓ Rake and check depth of loose fill protective surfacing materials to prevent compaction and maintain appropriate depth. Replace as necessary. (See Protective Surfacing, page 3)

If you dispose of your play set: Please disassemble and dispose of your unit so that it does not create any unreasonable hazards at the time it is discarded. Be sure to follow your local waste ordinances.

About Our Wood

KidKraft Premium Play Systems uses only premium playset lumber, ensuring the safest product for your children's use. Although we take great care in selecting the best quality lumber available, wood is still a product of nature and susceptible to weathering which can change the appearance of your set.

What causes weathering? Does it affect the strength of my Play System?

One of the main reasons for weathering is the effects of water (moisture); the moisture content of the wood at the surface is different than the interior of the wood. As the climate changes, moisture moves in or out of the wood, causing tension which can result in checking and or warping. You can expect the following due to weathering. These changes will not affect the strength of the product:

1. **Checking** is surface cracks in the wood along the grain. A post 4" x 4" (101mm x 101mm) will experience more checking than a board 1" x 4" (25mm x 101mm) because the surface and interior moisture content will vary more widely than in thinner wood.
2. **Warping** results from any distortion (twisting, cupping) from the original plane of the board and often happens from rapid wetting and drying of the wood.
3. **Fading** happens as a natural change in the wood color as it is exposed to sun-light and will turn a grey over time.

How can I reduce the amount of weathering to my Play System?

At the factory we have coated the wood with a water repellent or stain. This coating decreases the amount of water absorption during rain or snow thus decreasing the tension in the wood. Sunlight will break down the coating, so we recommend applying a water repellent or stain on a yearly basis (see your local stain and paint supplier for a recommended product).

Most weathering is just the normal result of nature and will not affect safe play and enjoyment for your child. However if you are concerned that a part has experienced a severe weathering problem please call our consumer relations department for further assistance.

Complete and mail registration card to receive important product notifications and assure prompt warranty service.

KidKraft Limited Warranty

MISSING OR DAMAGED PARTS:

KidKraft will replace any parts within 90 days from date of purchase found to be missing from or damaged in the original packaging. See Fig. 1

Fig. 1	<u>Product Age (All Parts)</u> 0-90 Days from date of purchase	<u>Consumer Pays</u> \$0 for Part + Free Shipping
--------	---	--

DEFECTS IN MATERIAL AND WORKMANSHIP:

KidKraft warrants that this product is free from defects in materials and workmanship for a period of one (1) year from the original date of purchase (dated sales receipt and/or product registration is required). This one (1) year warranty covers all parts including wood, hardware, and all accessories (Such as swings, rides, and slides). See Fig. 2

Fig. 2	<u>Product Age (All Parts)</u> 91 Days to 1 Year	<u>Consumer Pays</u> \$0 for Part + Free Shipping
--------	---	--

WOOD ROT, DECAY, AND INSECT DAMAGE:

All wood carries a five (5) year warranty against rot, decay, and insect damage (dated sales receipt and/or product registration is required). Refer to the schedule below for charges associated with replacement of wood parts under this **Limited Warranty**. See Fig. 3

Fig. 3	<u>Product Age (Wood Parts)</u> 0 Days to 1 Year After 1 Year to 5 Year Over 5 Years	<u>Consumer Pays</u> \$0 for Part + Free Shipping \$0 for Part + Shipping & Handling 100% for Part (if available) + Shipping & Handling
--------	---	--

This warranty applies to the original owner and registrant and is non-transferable. Regular maintenance is required to ensure the integrity of this product. Failure by the owner to maintain the product according to the maintenance requirements may void this warranty.

This Limited Warranty does NOT cover:

- Any inspection cost
- Labor and/or costs for replacement of any defective item(s), including but not limited to, professional installer costs
- Incidental or consequential damages, including but not limited to, as a result of set relocation, move and/or reinstall
- Cosmetic defects which do not affect performance or integrity of a part or the entire product
- Vandalism, improper use or installation, or acts of nature, including but not limited to, high winds, fire, and flood
- Minor twisting, warping, checking, or any natural occurring properties of wood that do not affect performance or integrity.
- Any KidKraft product purchased, including but not limited to, a non-approved retailer, auction houses, second-hand, and as-is clearance items.

KidKraft products have been designed for safety and quality. Modifications made to the original product may damage the structural integrity of the unit leading to failure and possible injury. KidKraft cannot assume any responsibility for the modified products. Furthermore, modifications void all warranties.

This product is warranted for **RESIDENTIAL USE ONLY**. Under no circumstance should a KidKraft product be used in public settings such as schools, churches, playgrounds, parks, home and professional day cares and the like. Such use may lead to product failure and potential injury. Public use will void this warranty. KidKraft disclaims all other representations and warranties of any kind, express or implied.



Keys to Assembly Success

Tools Required

<ul style="list-style-type: none"> • Tape Measure • Carpenters Level • Carpenters Square • Claw Hammer • Standard or Cordless Drill • Rubber Mallet 	<ul style="list-style-type: none"> • #1 Phillips, #2 Robertson and Screwdriver • Ratchet with extension 1/2" (13mm) & 9/16" (14 mm) sockets 	<ul style="list-style-type: none"> • Open End Wrench 1/2" (13mm) & 9/16" (14 mm) • Adjustable Wrench • 1/8" (3mm) & 3/16" (5mm) Drill Bits • 3/16" Hex Head Allen Wrench Driver Bit 	<ul style="list-style-type: none"> • 3/16" (5mm) Hex Key • 8' (2.4m) Step Ladder • Safety Glasses • Adult Helpers • Pencil
---	---	---	---

Part Identification Key

On each page, you will find the parts and quantities required to complete the assembly step illustrated on that page. Here is a sample.

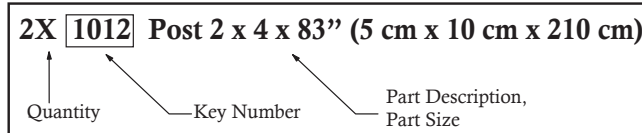

Symbols

Throughout these instructions symbols are provided as important reminders for proper and safe assembly.

<p>This identifies information that requires special attention. Improper assembly could lead to an unsafe or dangerous condition.</p>	<p>Check that set or assembly is properly level before proceeding.</p> <p>Use Level</p>
<p>Use Help</p> <p>Where this is shown, 2 or 3 people are required to safely complete the step. To avoid injury or damage to the assembly make sure to get help!</p>	<p>Pre-drill 1/8" (3mm) & 3/16" (5mm) Bit</p> <p>Pre-drill a pilot hole before fastening screw or lag to prevent splitting of wood.</p>
<p>Measure Distance</p> <p>Use a measuring tape to assure proper location.</p>	<p>Tighten Bolts</p> <p>This indicates time to tighten bolts, but not too tight! Do not crush the wood. This may create splinters and cause structural damage.</p>
<p>Check that assembly is square before tightening bolts.</p> <p>Square Assembly</p>	

CAUTION – Protrusion Hazard

Once the assembly is tightened, watch for exposed threads. If a thread protrudes from the T-Nut, remove the bolt and add washers to eliminate this condition. Extra washers have been provided for this purpose.

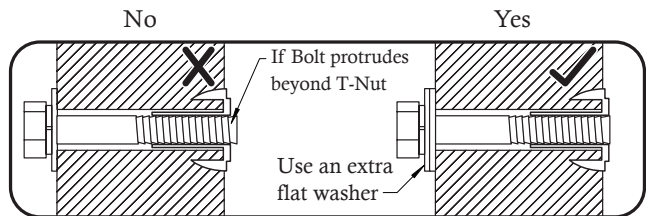

Proper Hardware Assembly

Lag screws require drilling pilot holes to avoid splitting wood. Only a flat washer is required. For ease of installation liquid soap can be used on all lag-type screws.

For bolts, tap T-Nut into hole with hammer. Insert the hex bolt through lock washer first then flat washer then hole. Because the assemblies need to be squared do not completely tighten until instructed. Pay close attention to diameter of the bolts. 5/16" (8mm) is slightly larger than 1/4" (6.4mm).

Note: Wafer head bolts with blue lock tight or a bolt with a Ny-Lok nut do NOT require a lock washer.

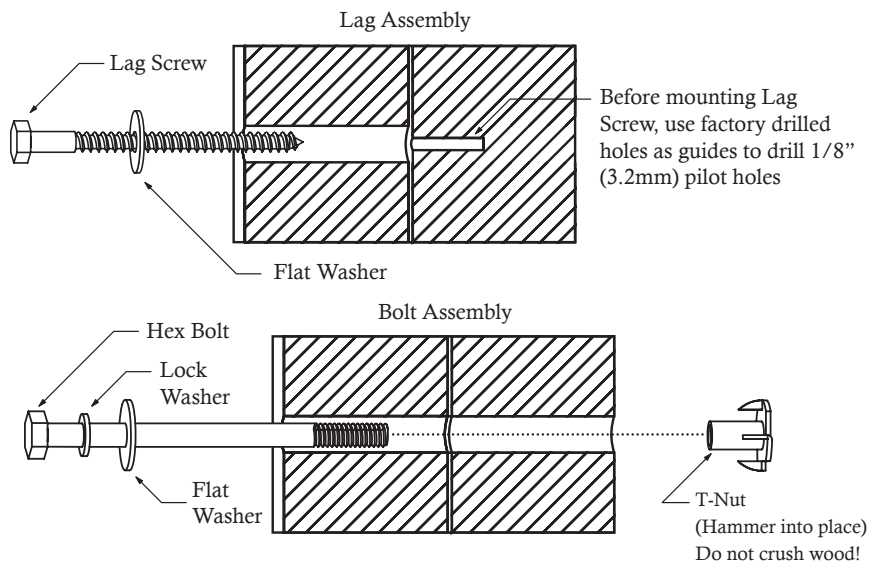

Part Identification (Reduced Size)

1x - 9686 - 31.8 x 76.2 x 1251.0mm - 3739686

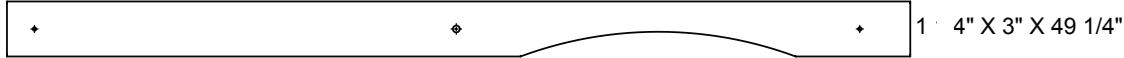

1x - 9687 - 31.8 x 63.5 x 660.4mm - 3739687



1x - 9688 - 25.4 x 76.2 x 635 mm - 3739688



4x - 9689 - 76.2 x 76.2 x 186.6 mm - 3739689

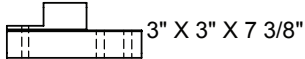

1x - 9691 - 31.8 x 63.5 x 1219.2 mm - 3739691



2x - 9696 - 31.8 x 76.2 x 914.4 mm - 3739696

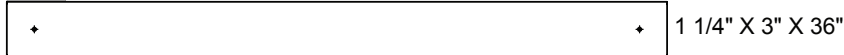

8x - 9697 - 15.9 x 76.2 x 549 mm - 3739697

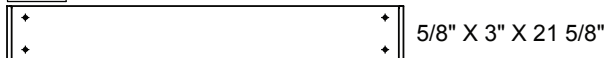

1x - 9699 - 31.8 x 76.2 x 457.2 mm - 3739699

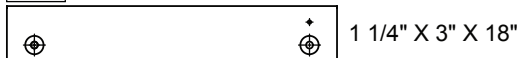

2x - 9746 - 31.8 x 76.2 x 457.2 mm - 3739746



2x - 9701 - 31.8 x 76.2 x 977.9 mm - 3739701

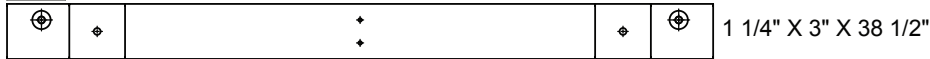

2x - 9702 - 31.8 x 76.2 x 876.3 mm - 3739702

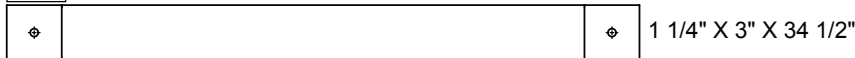

4x - 9703 - 15.9 x 76.2 x 715.1 mm - 3739703

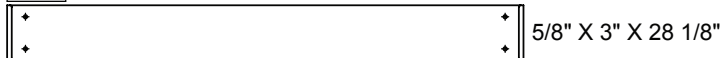

1x - 9704 - 31.8 x 76.2 x 759.9 mm - 3739704

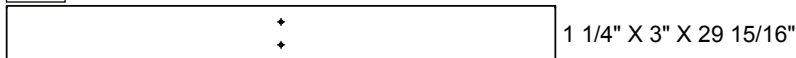

1x - 9705 - 31.8 x 63.5 x 424.4 mm - 3739705

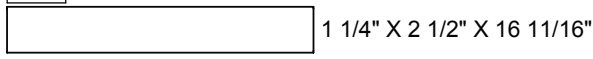

1x - 9709 - 31.8 x 76.2 x 431.8 mm - 3739709

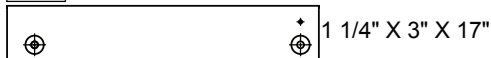

1x - 9710 - 31.8 x 31.8 x 650 mm - 3739710

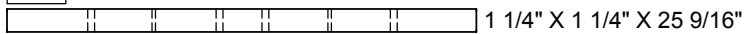

1x - 9715 - 31.8 x 76.2 x 1154.6 mm - 3739715



5x - 9717 - 15.9 x 133.4 x 482.6 mm - 3779717

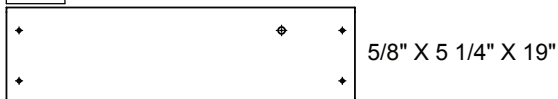

Part Identification (Reduced Size)

2x - **9718** - 15.9 x 133.4 x 482.6mm - 3779718



2x - **9720** - 50.8 x 76.2 x 2063.9mm - 3739720

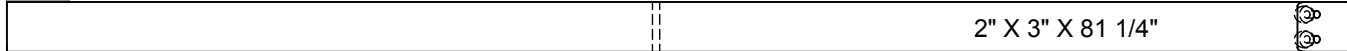

1x - **8965** - 31.8 x 76.2 x 514.4 mm - 3738965



1x - **9722** - 31.8 x 76.2 x 857.3 mm - 3739722

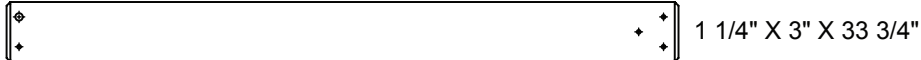

4x - **10591** - 15.9 x 85.7 x 440.0 mm - 37310591

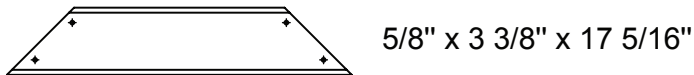

1x - **9719** - 15.9 x 76.2 x 482.6 mm - 3779719



1x - **9292** - 28.6 x 1270 x 801.7 - 37779292

1 1/8" X 50" X 31 9/16"

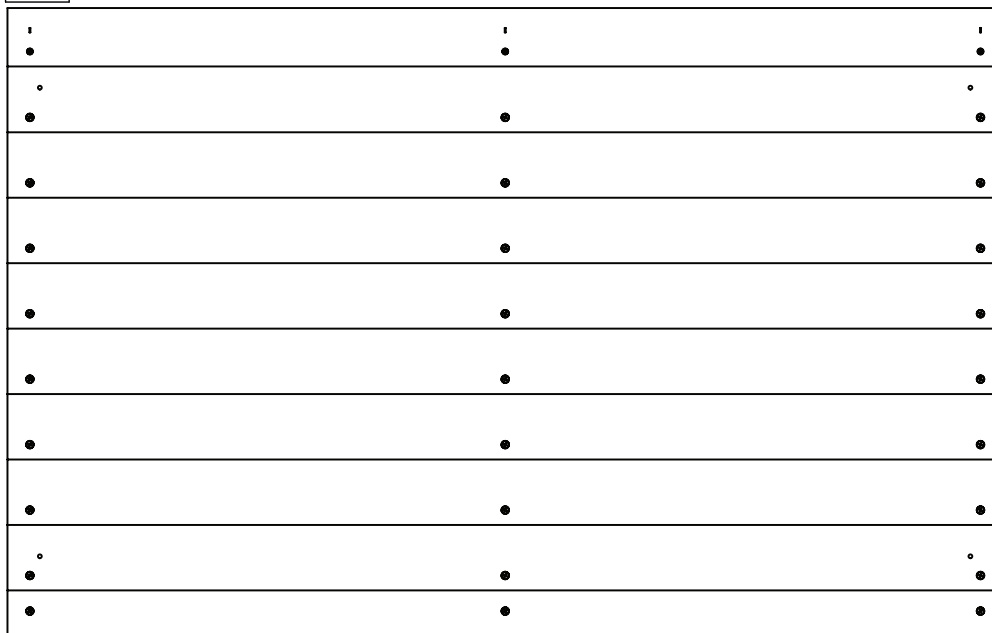

Part Identification (Reduced Size)

1x - 9297 - 108 x 914 x 2336.6mm - 37739297

4-1/4" X 36" X 92"

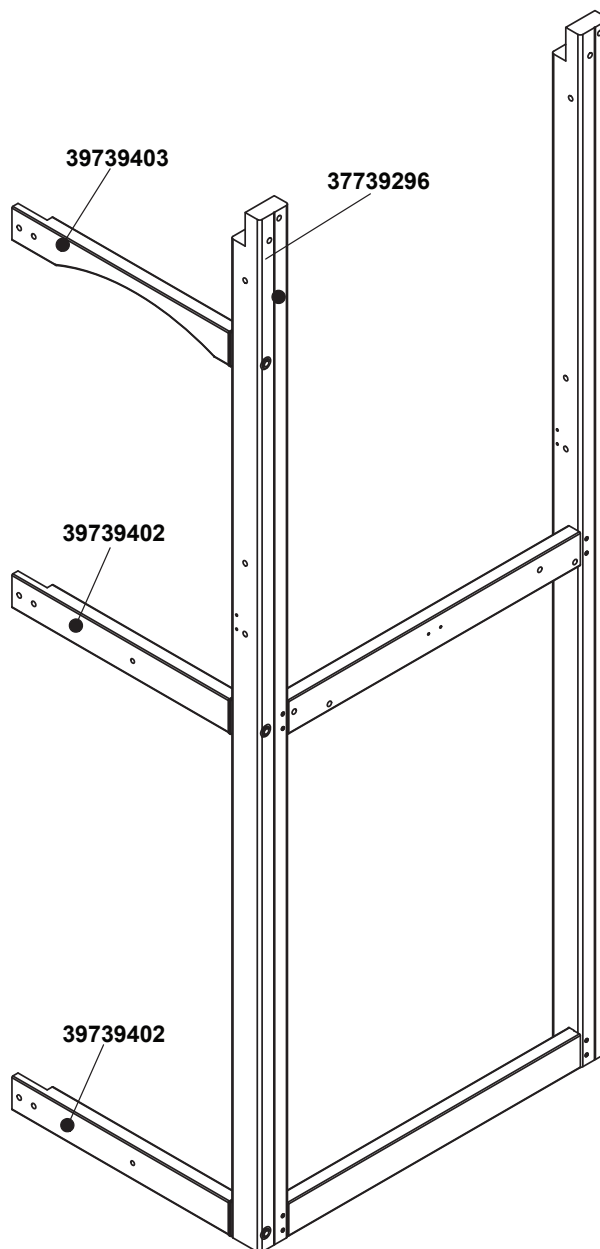
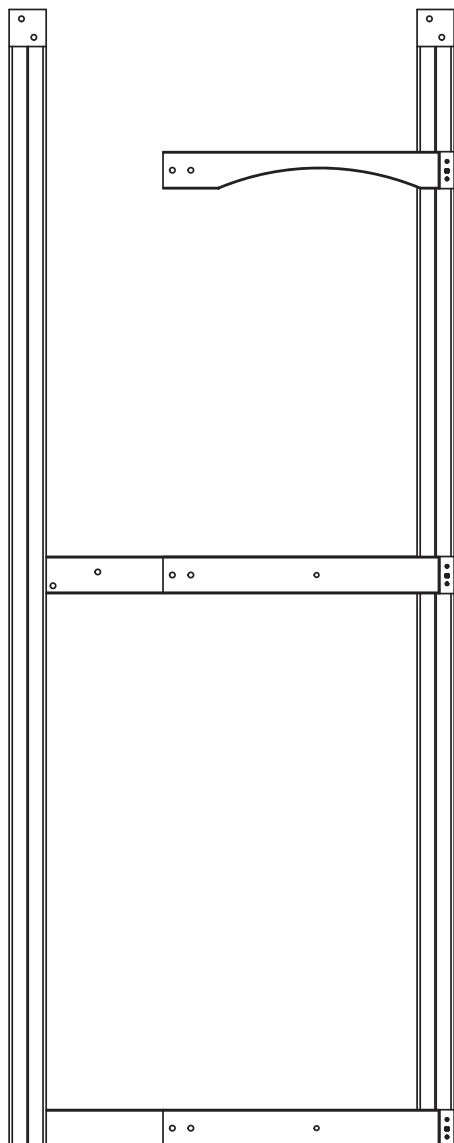

If you need to order parts, please order below part #

37739296 - Open Panel - 1pc

39739402 - Swing Arm -1pc

39739403 - Export top -1pc

9327884 - Hinge - 1pc

(S0) - 52933505 - Truss Screw #8 x 7/8" - 1pc

(LS3) - 52213230 - Lag Screw 1/4 x 3 Yellow Zinc - 1pc

(FW1) - 51103200 - Washer Flat 1/4" - 1pc

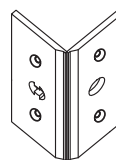

9327884



(LS3) - 52213230



(FW1) - 51103200



(S0) - 52933505

Part Identification (Reduced Size)

2x - [9700] - 31.8 x 76.2 x 876.3 mm - 3739700

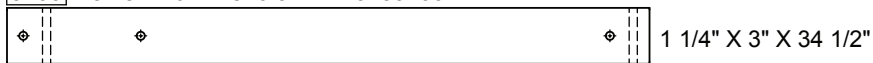

1x - [9706] - 15.9 x 114.3 x 977.9 mm - 3779706

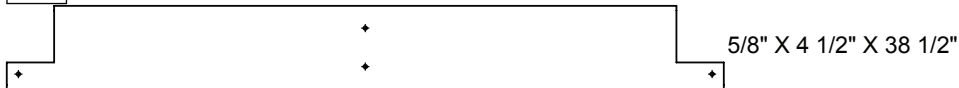

2x - [9707] - 15.9 x 114.3 x 977.9 mm - 3779707

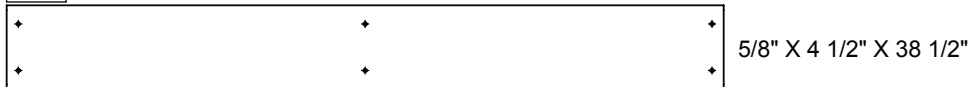

1x - [9708] - 15.9 x 109 x 977.9 mm - 3779708



3x - [9711] - 15.9 x 76.2 x 914.4 mm - 3739711

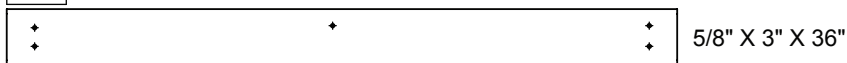

2x - [9712] - 31.8 x 50.8 x 1079.5 mm - 3739712



4x - [9713] - 31.8 x 50.8 x 691.1 mm - 3739713

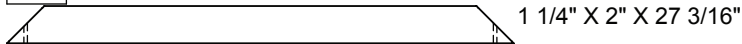

1x - [9714] - 31.8 x 133.4 x 914.4 mm - 3739714

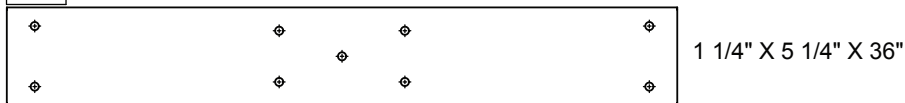

2x - [9716] - 34.9 x 63.5 x 1332.8 mm - 3779716

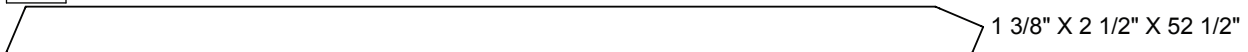

1x - [2614] - 76.2 x 133.4 x 2235.2 mm - 3732614



1x - [2615] - 76.2 x 76.2 x 1294.3 mm - 3732615

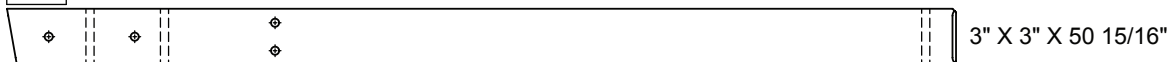

1x - [2616] - 23.8 x 82.6 x 1181.1 mm - 3732616



2x - [9721] - 31.8 x 31.8 x 1064.8 mm - 3739721



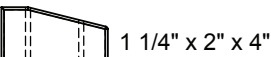

2x - [10662] - 31.8 x 50.8 x 101.6 mm - 37310662

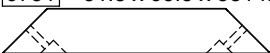

Part Identification (Reduced Size)

8x - **9731** - 31.8 x 63.5 x 381 mm - 3739731
 1 1/4" X 2 1/2" X 15"

2x - **9732** - 31.8 x 76.2 x 530 mm - 3739732
 1 1/4" X 3" X 20 7/8"

1x - **9735** - 31.8 x 31.8 x 914.4 mm - 3739735
 1 1/4" X 1 1/4" X 36"

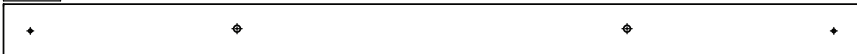
2x - **9685** - 31.8 x 76.2 x 1219.2 mm - 3739685
 1 1/4" X 3" X 48"

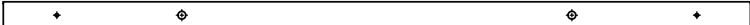
2x - **9690** - 38.1 x 38.1 x 1062.8 mm - 3739690
 1 1/2" X 1 1/2" X 41 13/16"

8x - **9692** - 15.9 x 114.3 x 880.6 mm - 3779692
 5/8" X 4 1/2" X 34 11/16"

2x - **9693** - 15.9 x 114.3 x 880.6 mm - 3779693
 5/8" X 4 1/2" X 34 11/16"

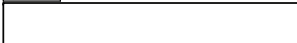
4x - **9694** - 31.8 x 63.5 x 421 mm - 3739694
 1 1/4" X 2 1/2" X 16 9/16"

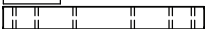
4x - **9695** - 31.8 x 31.8 x 285.9 mm - 3739695
 1 1/4" X 1 1/4" X 11 1/4"

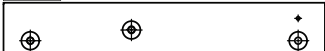
1x - **9698** - 31.8 x 76.2 x 457.2 mm - 3739698
 1 1/4" X 3" X 18"

1x - **9745** - 31.8 x 76.2 x 457.2 mm - 3739745
 1 1/4" X 3" X 18"

1x - **9293** - 28.6 x 1270 x 807.5 mm - 37779293 1 1/8" X 50" X 31 13/16"



Part Identification (Reduced Size)

1x - [9295] - 108 x 914 x 2336.6 - 37739295

4 1/4" X 36" X 92"

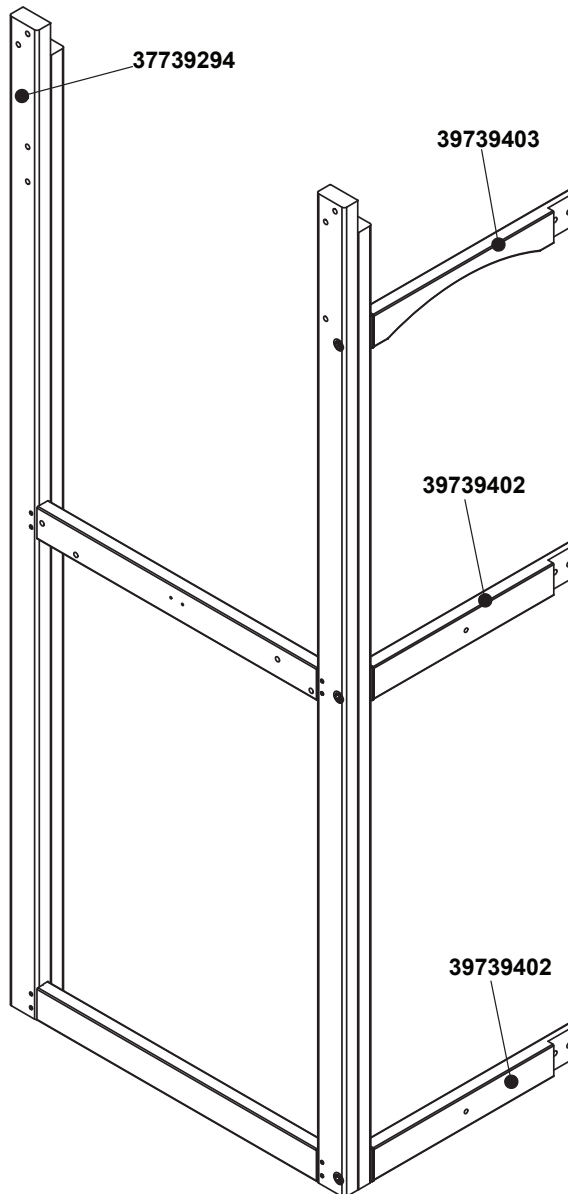
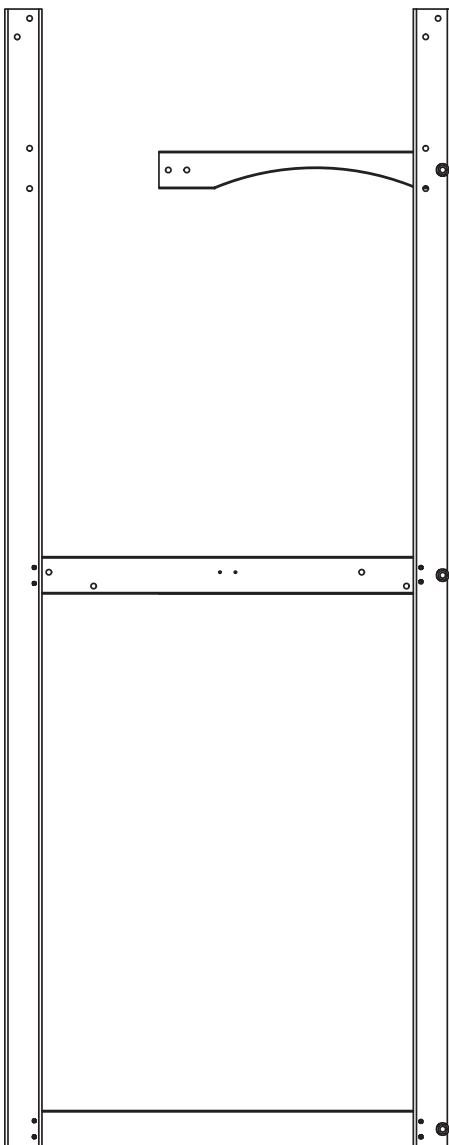

If you need to order parts, please order below part #

37739294 - SW Panel - 1pc

39739402 - Swing Arm -1pc

39739403 - Export top -1pc

9327884 - Hinge - 1pc

(S0) - 52933505 - Truss Screw #8 x 7/8" - 1pc

(LS3) - 52213230 - Lag Screw 1/4 x 3 Yellow Zinc - 1pc

(FW1) - 51103200 - Washer Flat 1/4" - 1pc

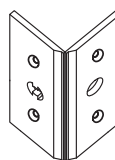

9327884



(LS3) - 52213230



(FW1) - 51103200



(S0) - 52933505



parts.kidkraft.com

customerservice@kidkraft.com
1.800.933.0771
972.385.0100

Hardware Identification (Actual Size)

36x - **LW2** - 5/16" - (51303300)
7.9mm



26x - **LW1** - 1/4" - (51303200)
6.4mm



60x - **LN1** - 1/4" - (54303200)
6.4mm



23x - **LN2** - 5/16" (54303300)
7.9mm

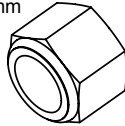

5x - **FW0** - 3/16" - (51103100)
4.8mm



35x - **FW1** - 1/4" - (51103200)
6.4mm

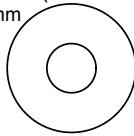

119x - **FW2** - 5/16" - (51103300)
7.9mm

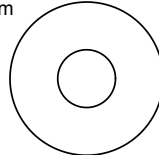

8x - **FW6** - #12 - (9299500)

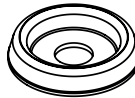

26x - **TN1** - 1/4" - (54503200)
6.4mm

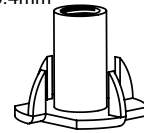

42x - **TN2** - 5/16" - (54503300)
7.9mm

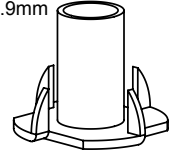

5x - **BN1** - 1/4" - (54803200)
6.4mm

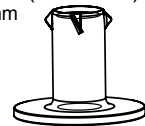

63x - **S0** - #8 x 7/8" - (52933505)
22.2mm

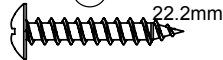

4x - **S18** - #6 x 1" - (52013910)
25.4mm

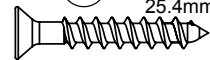

186x - **S20** - #8 x 1-3/8" - (52043516)
34.9mm

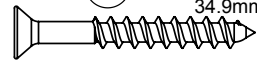

16x - **S11** - #8 x 2" - (52043520)
50.8mm



30x - **S3** - #8 x 2-1/2" - (52043522)
63.5mm

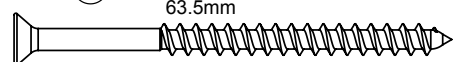

40x - **S4** - #8 x 3" - (52043530)
76.2mm



4x - **S24** - #10 x 4" - (52043940)
25.4mm

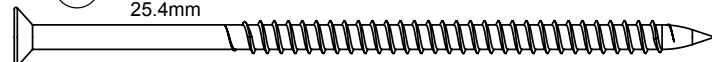

18x - **S6** - #12 x 1" - (52433610)
25.4mm

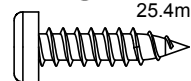

28x - **S37** - #7 x 5/8" - (52433009)
15.8mm

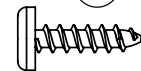

5x - **S10** - #8 x 1" - (52433510)
25.4mm

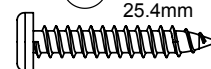

57x - **S7** - #12 x 2" - (52433620)
50.8mm

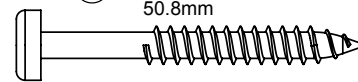

33x - **WL5** - 1/4 x 2-1/2" - (52613222)
6.4 x 63.5mm

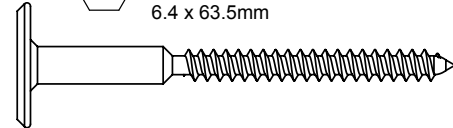

8x - **WL3** - 1/4 x 1-3/8" - (52613216)
34.9mm

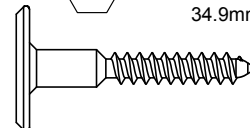

Hardware Identification (Actual Size)

49x - **(PB1)** - 1/4 x 3/4" - (53413203)
6.4 x 19.1mm

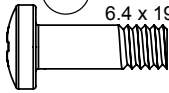

11x - **(PB6)** - 1/4 x 1" - (53413210)
6.4 x 25.4mm

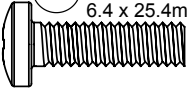

5x - **(PB2)** - 1/4 x 1-1/4" - (53433212)
6.4 x 31.8mm

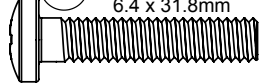

14x - **(H2)** - 1/4 x 2" - (53703220)
6.4 x 50.8mm

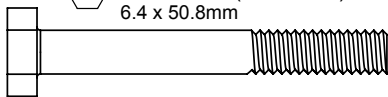

10x - **(WB2)** - 5/16 x 1-3/8" - (53613316)
7.9 x 25.4mm

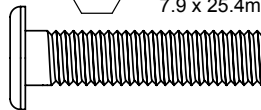

1x - **(WB8)** - 5/16 x 2-3/8" - (53613326)
7.9 x 60.3mm

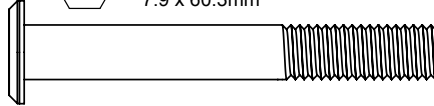

4x - **(WB10)** - 5/16 x 2-5/8" - (53613329)
7.9 x 66.7mm

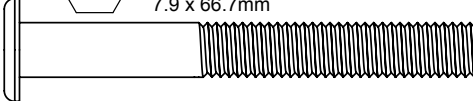

11x - **(WB7)** - 5/16 x 3" - (53613330)
7.9 x 76.2mm

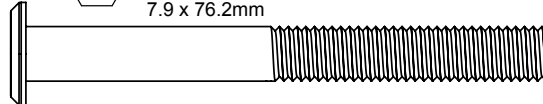

13x - **(H8)** - 1/4 x 4-1/4" - (53703241)
6.4 x 108mm

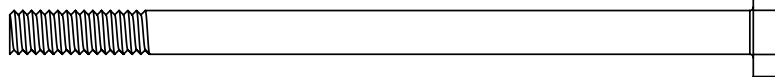

4x - **(H12)** - 1/4 x 3" - (53703230)
6.4 x 76.2mm

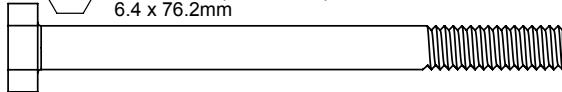

4x - **(G8)** - 5/16 x 2" - (53703320)
7.9 x 50.8mm

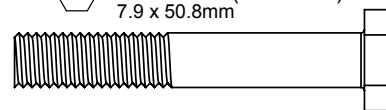

13x - **(G21)** - 5/16 x 3-3/4" - (53703333)
7.9 x 95.3mm

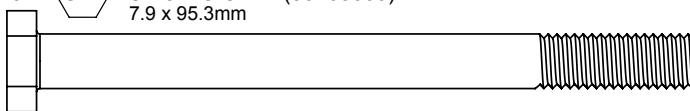

10x - **(G4)** - 5/16 x 4" - (53703340)
7.9 x 101.6mm

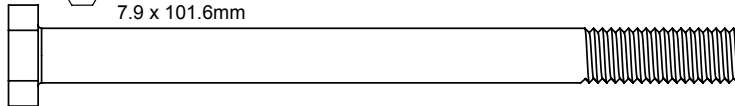

14x - **(G7)** - 5/16 x 5-1/2" - (53703352)
7.9 x 139.7mm

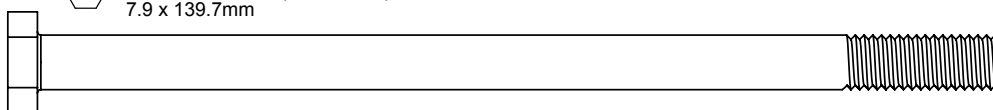

2x - **(H10)** - 1/4 x 2-1/4" - (53703221)
6.4 x 57.2mm

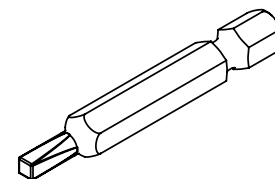
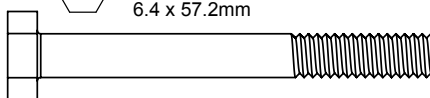

1x - **(D4)** - #2 x 2 - (9200014)

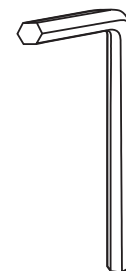

1x - 3/16" - (9200022)

Note: Hardware bag includes extra hardware

Part Identification (Reduced Part Size)

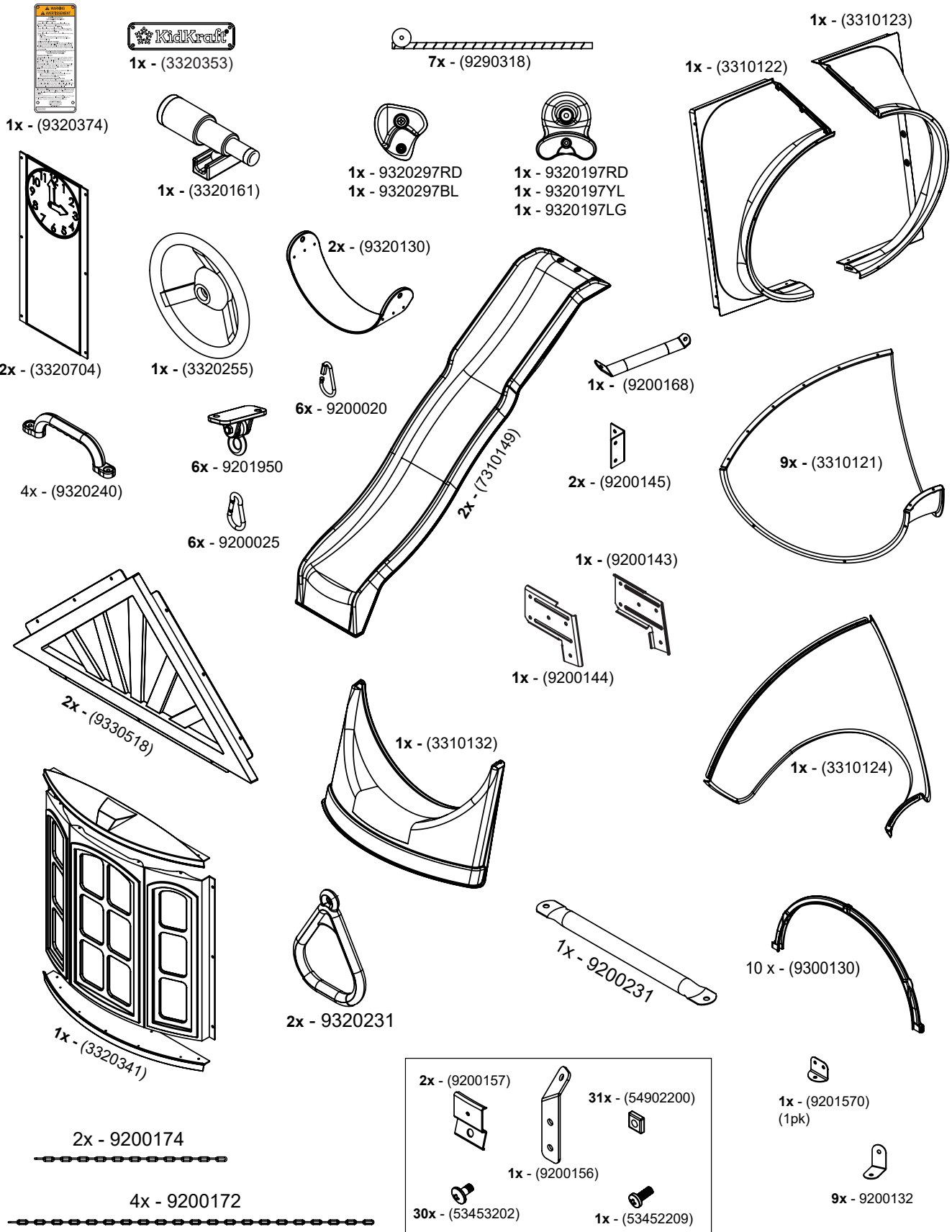

1 Inventory Parts - Read This Before Starting Assembly

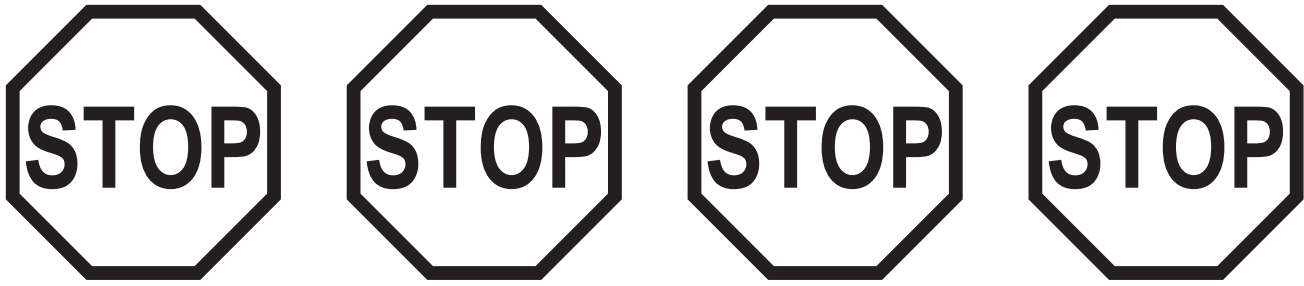

Inventory should be completed before starting installation. KidKraft will not cover costs of any additional installation trip due to missing or damaged pieces.

A. This is the time for you to inventory all your hardware, wood and accessories, referencing the parts identification sheets. This will assist you with your assembly.

- The wood pieces will have the key number stamped on the ends of the boards. Organize the wood pieces by step, as per the key numbering system below.

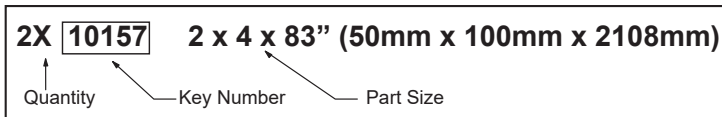

B. Read the assembly manual completely, paying special attention to ANSI warnings; notes; and safety/maintenance information on pages 1 - 9.

**If there are missing or damaged pieces,
please contact the KidKraft Consumer Engagement team
before going back to the retailer.**

Order Replacement Parts 24/7

You can order replacement parts for this product 24 hours a day / 7 days a week:

Outdoor Swingsets and Playhouse Parts Ordering

<https://parts.kidkraft.com/partsorderemail>

If you have assembly or product questions, please refer to the front cover for direct contact information for our Consumer Engagement team OR you can also use this QR code with your smartphone for common questions and contact information.

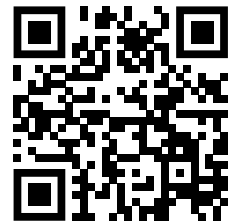

KidKraft Help Center **<https://kidkraft.zendesk.com/hc/en-us/>**

2

Assemble T-Nuts first with hammer!

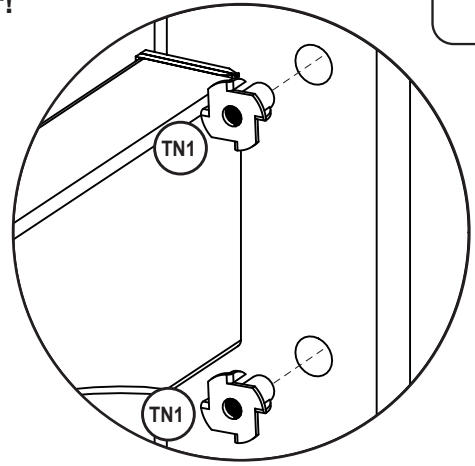
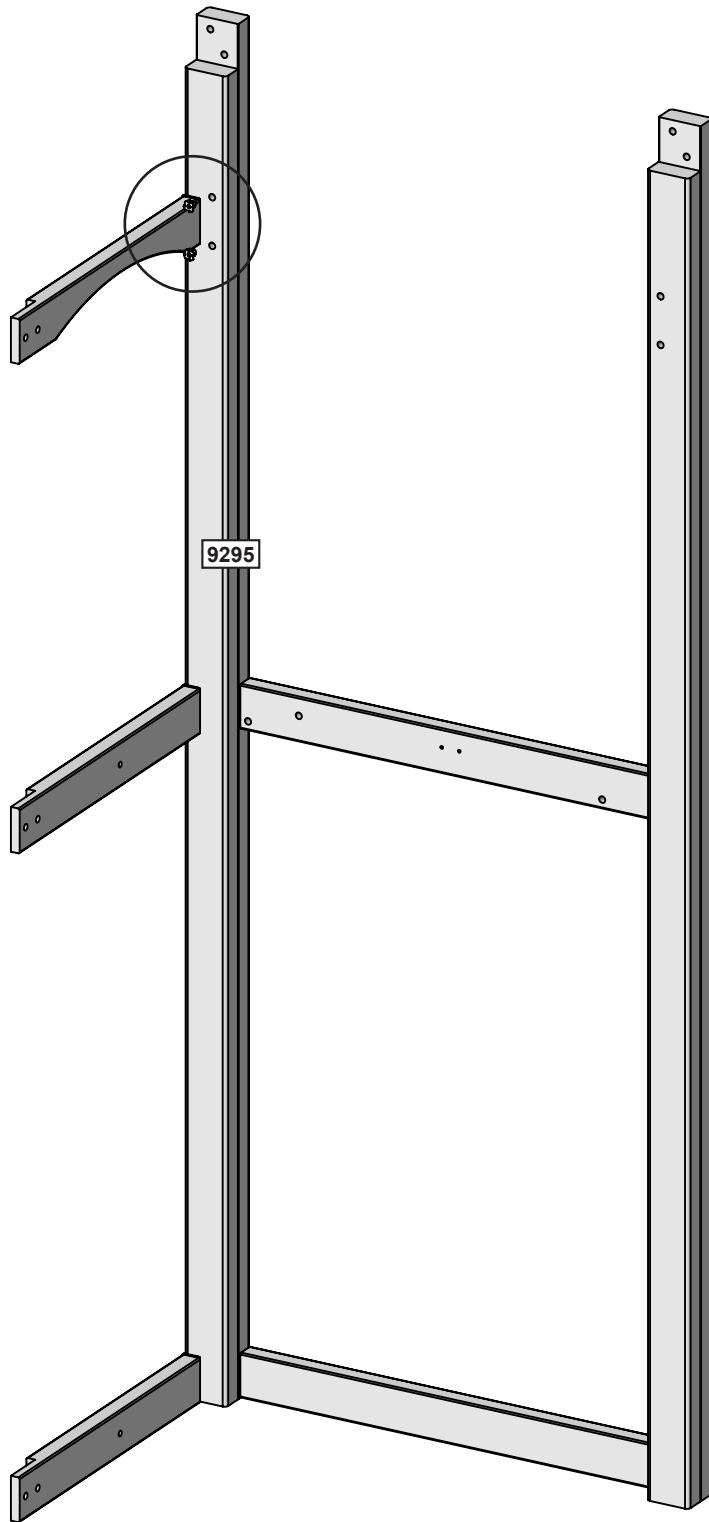

Wood Parts

1 x **9295** 108 x 914 x 2336.8mm (4-1/4" x 36" x 92")

Hardware

2 x **TN1**

europcustomerservice@kidkraft.com
+31 20 305 8620
M-F from 09:00 to 17:30 (GMT+1)

parts.kidkraft.eu



3

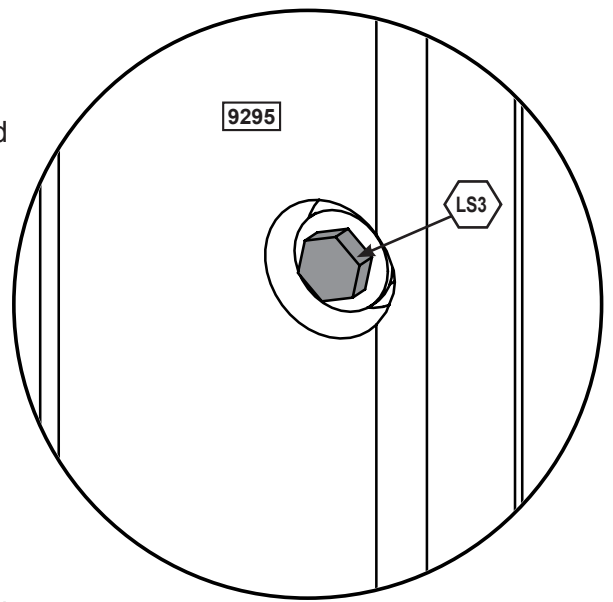
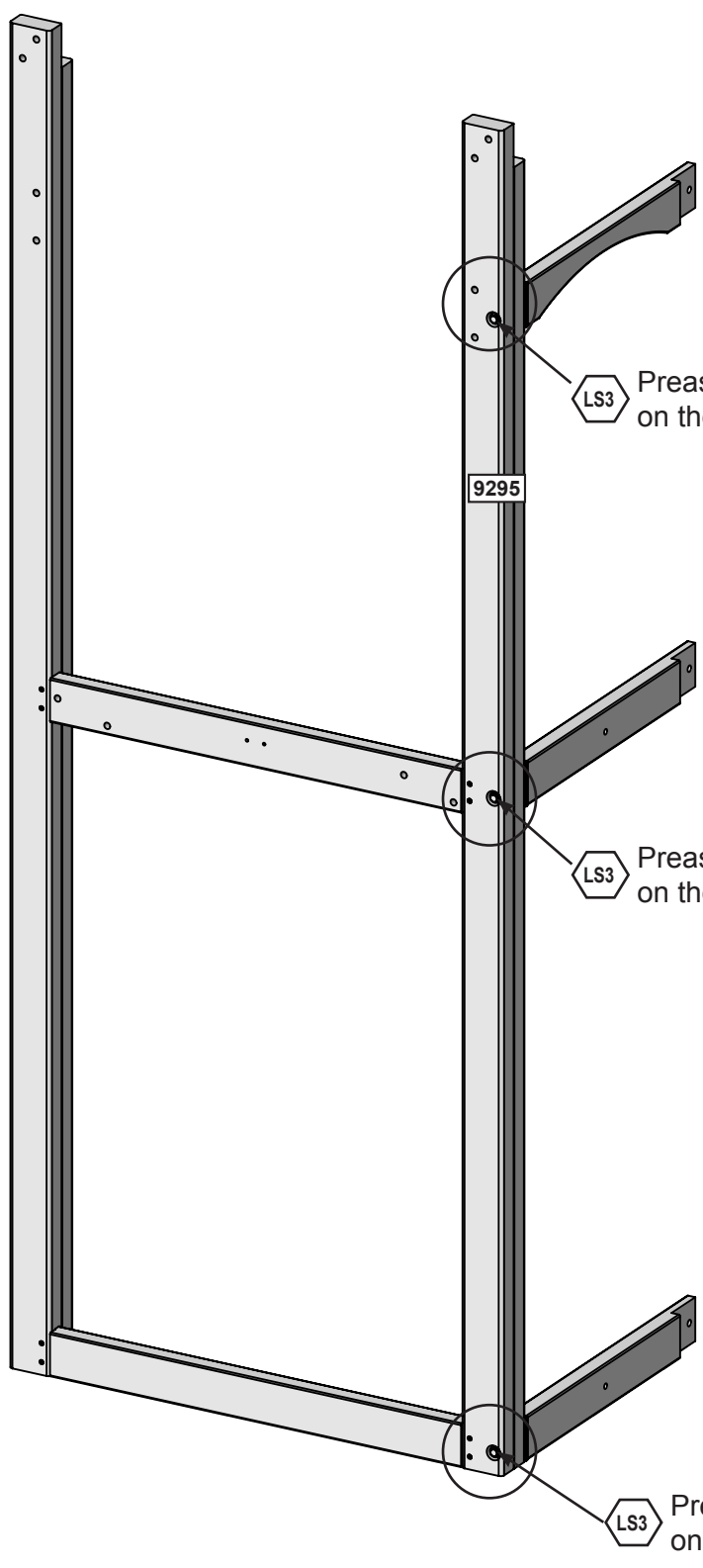
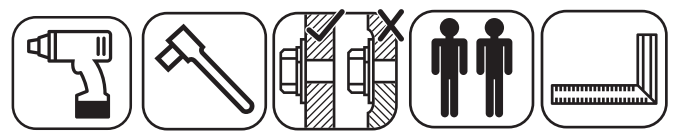

4

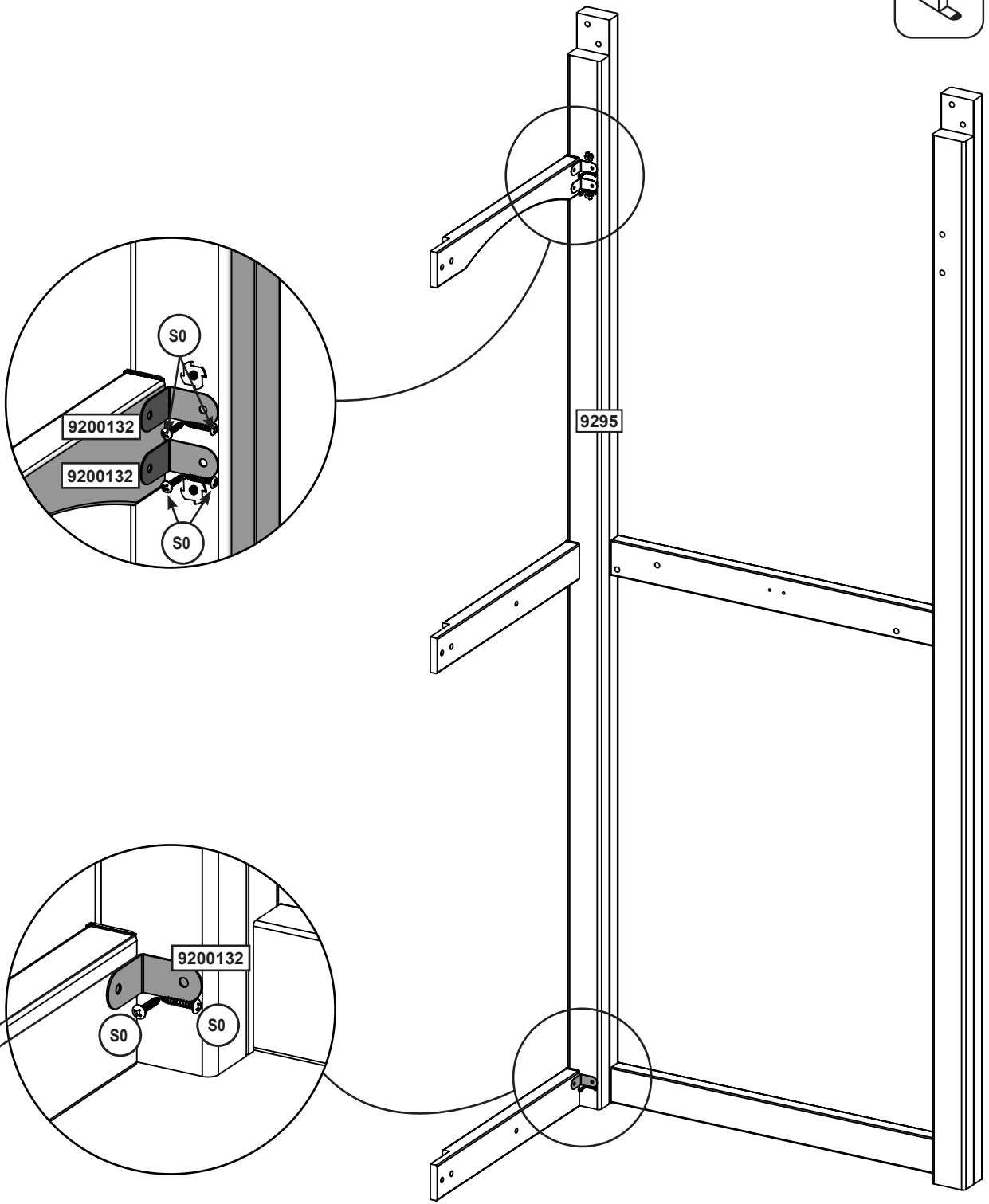
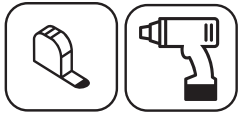

Hardware

6 x #8 x 22.2mm (#8 x 7/8")

Other Parts

3 x 9200132

europecustomerservice@kidkraft.com
+31 20 305 8620
M-F from 09:00 to 17:30 (GMT+1)

parts.kidkraft.eu



5

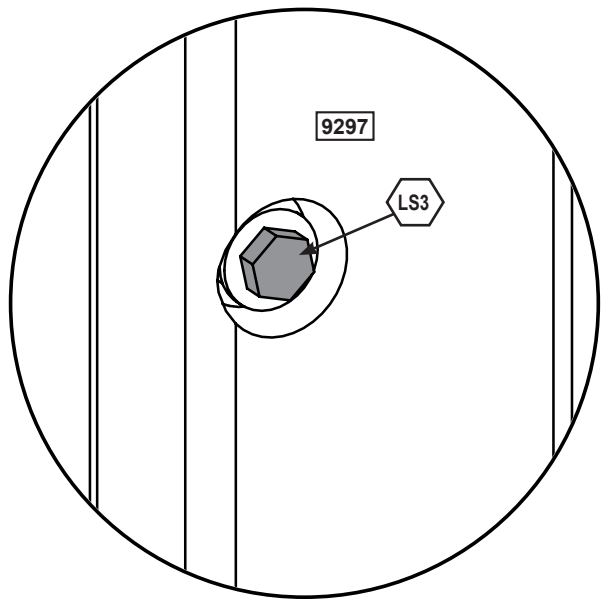
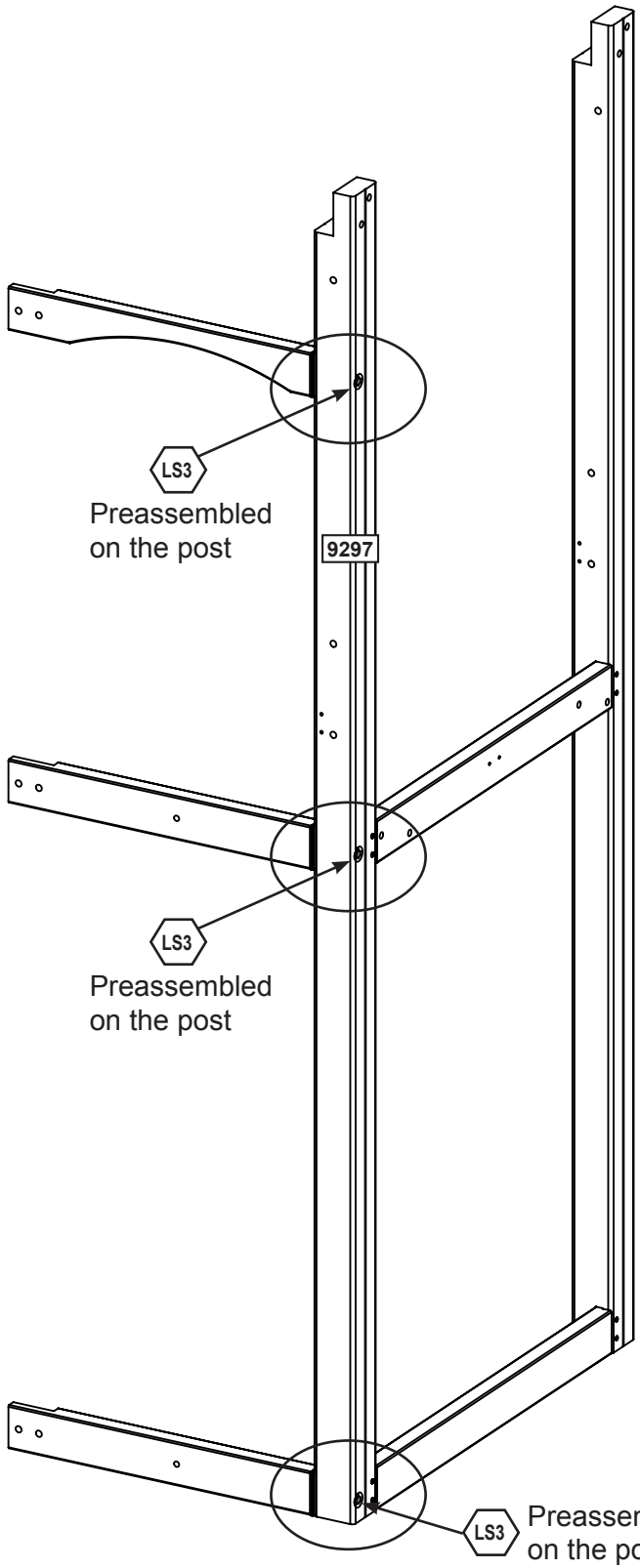
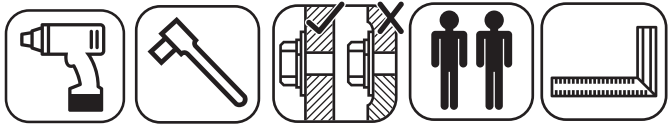

Wood Parts

1 x 9297 108 x 914 x 2336.8mm (4-1/4" x 36" x 92")



parts.kidkraft.com

customerservice@kidkraft.com
 1.800.933.0771
 972.385.0100

6

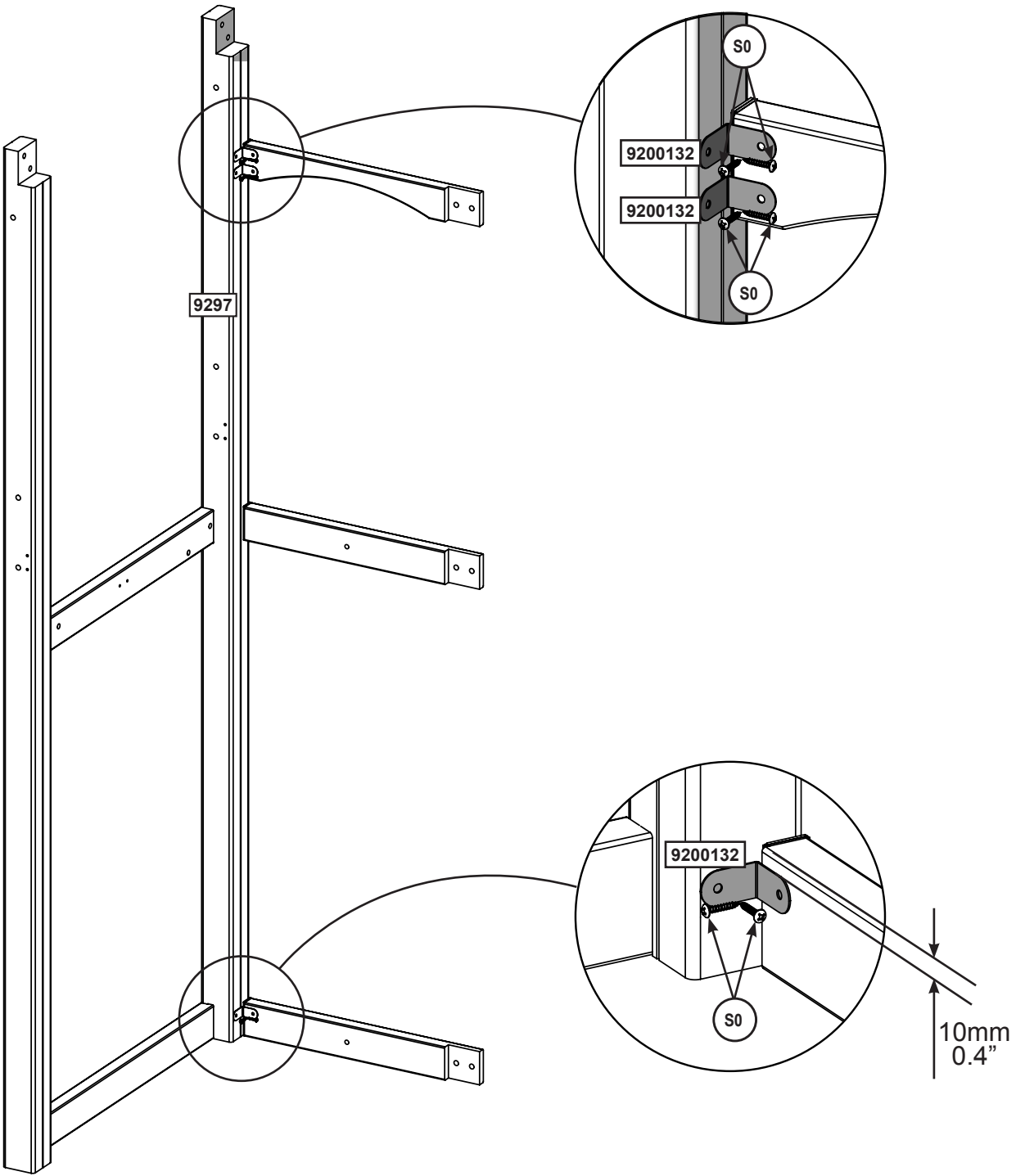
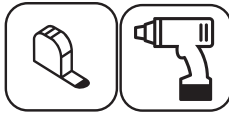

Hardware

6 x #8 x 22.2mm (#8 x 7/8")

Other Parts

3 x

europecustomerservice@kidkraft.com
+31 20 305 8620
M-F from 09:00 to 17:30 (GMT+1)

parts.kidkraft.eu



7



Assemble T-Nuts first with hammer!

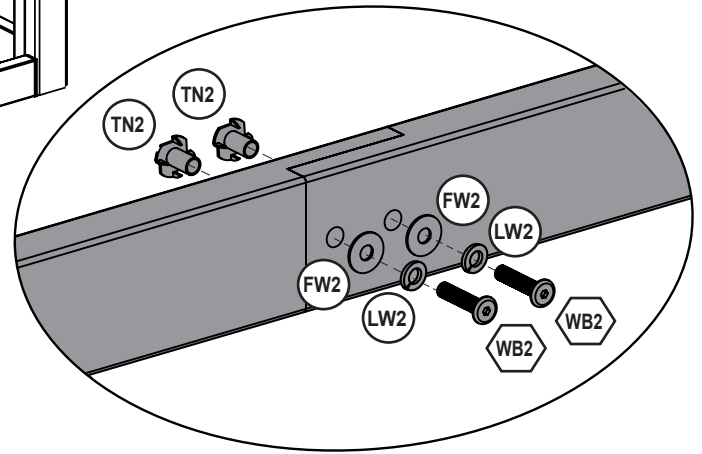
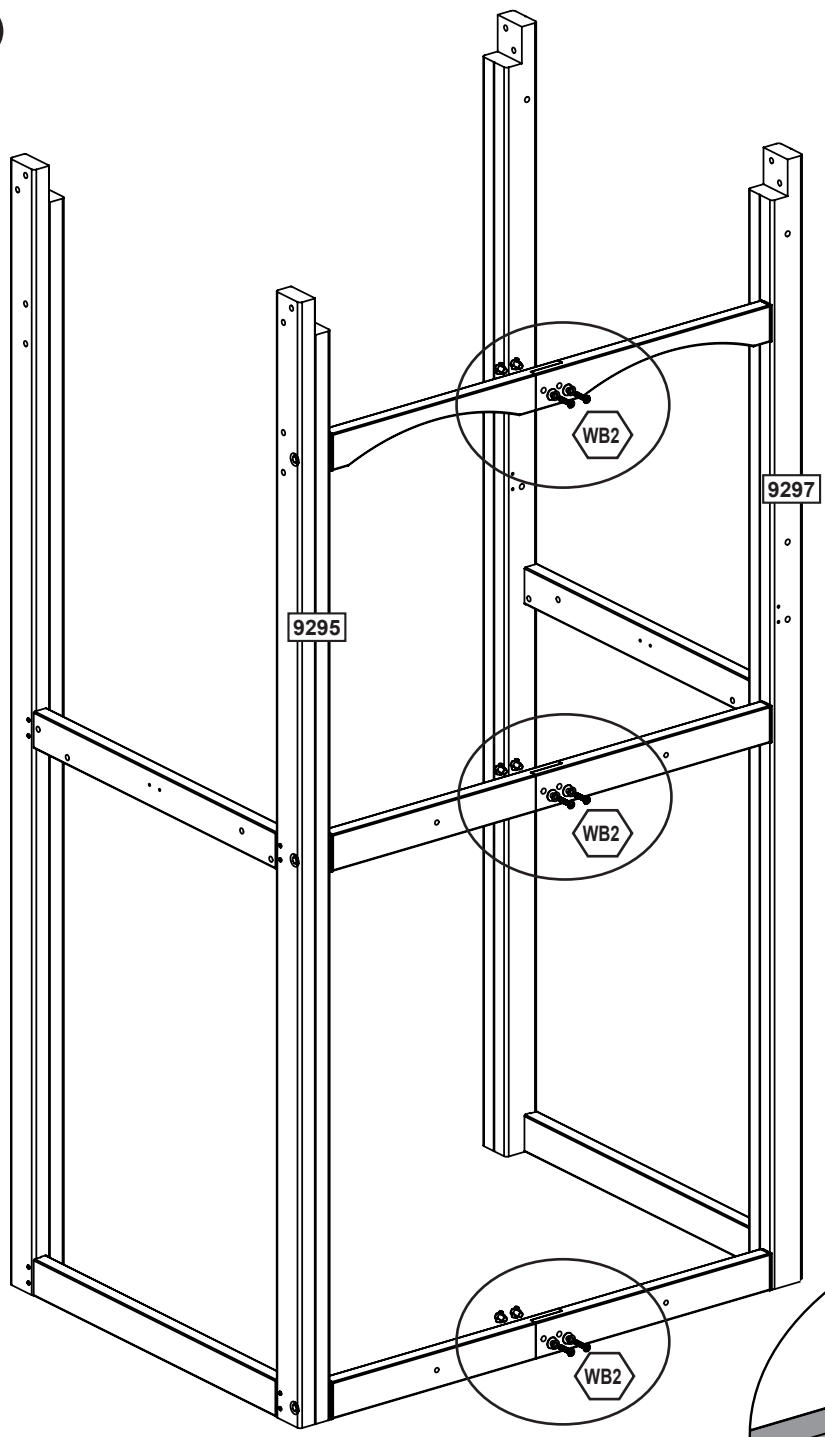

Hardware

6 x  7.9mm x 35 mm (5/16 x 1-3/8") (FW2, LW2, TN2)



parts.kidkraft.com

customerservice@kidkraft.com
1.800.933.0771
972.385.0100