

1500W PORTABLE SPLASH RESISTANT GREENHOUSE FAN HEATER

with Digital Thermostat & Humidity Sensor

IT-68



		
USA	customer.service@palram.com	877-627-8476
England	customer.serviceUK@palram.com	01302-380775
France	customer.serviceFR@palram.com	0169-791-094
Germany	customer.serviceDE@palram.com	0180-522-8778
International	customer.service@palram.com	+972 (4) 848-6816

The Manual Is Divided In 6 Parts.

CAUTION:



KEEP CHILDREN AWAY
TO REDUCE THE RISK OF ELECTRIC SHOCK, USE ONLY
INDOORS
RISK OF ELECTRIC SHOCK. DO NOT PLUG INTO ANOTHER
RELOCATABLE POWER TAPS OR AN EXTENSION CORD.
USE ONLY IN DRY LOCATION

- Part 1 Quick Start Guide
- Part 2 Temperature Controller Manual
- Part 3 Programmable Temperature
Controller Manual
- Part 4 Dual Temperature Probes
Controller Manual
- Part 5 Humidity Controller Manual
- Part 6 Humidity & Temperature
Controller Manual

Part 1



Quick Start Guide

1 Quick Start Guide - Temperature Setting only for basic use

- ① Insert the Temperature Probe into P1 interface



- ② Insert Heater plug into WORK1

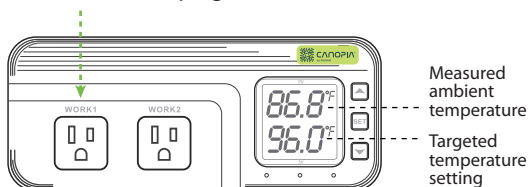

- ③ Turn the buttons on the Fan heater
to Heat and Max

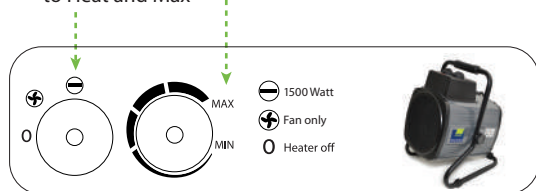

4 Shortly press SET button

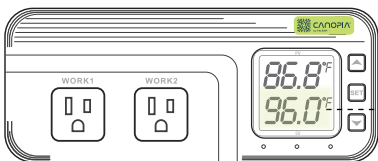

The Temperature Setting screen will start flashing

5 Use Arrows to set up your Heating System to the desired temperature

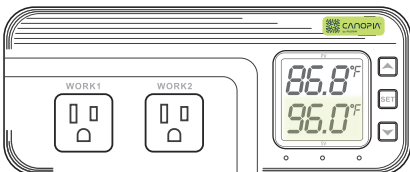

6 Shortly press SET button to exit setup mode

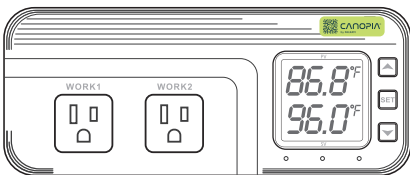

NOTE:

Your Controller features many other functions. Hold the SET button 2 seconds to access the Menu displaying all functions.

Hold the SET button 2 seconds to exit the Menu.

2 Specification

Power

Voltage: 120Vac 60Hz

Current: 15A

Wattage: 1800W

Temperature Probe (optional)

Type of temperature probe: R25°C=10KΩ±1%,

R0°C=26.74~27.83KΩ, B25/85°C=3435K±1%

Temperature measurement range: -40°C~100°C/-40°F~212°F

Temperature display accuracy: 0.1°C/°F(<100°C/°F),
1°C/°F(>=100°C/°F)

Temperature measurement accuracy:

Range of Temperature Celsius	Celsius Error	Range of Temperature Fahrenheit	Fahrenheit Error
-40°C≤T<10 °C	±2 °C	-40°F≤T<50 °F	±3 °F
10°C≤T<80 °C	±1 °C	50°F≤T<176 °F	±2 °F
80°C≤T≤100 °C	±2 °C	176°F≤T≤212 °F	±3 °F

Humidity Probe(optional)

Type of humidity probe: HTG3515CH

Relative humidity measurement range: 5%~99%RH

Humidity display accuracy: 0.1%RH

Relative humidity measurement accuracy(10%~95%RH):

Typical value:±3%RH,Maximum value:±5%RH, Maximum value±5%RH

Display unit: temperature: Celsius °C or Fahrenheit °F;
humidity: %RH

Ambient

Ambient temperature: -20°C~60°C/-4°F~140°F

Storage environment: temperature: 0°C~60°C/32°F~140°F;

humidity: 20%~80%RH(Unfrozen or condensation state)

Warranty

Controller: Two years warranty

Temperature and Humidity Probe: One year warranty

3 Technical Assistance and Warranty

3.1 Technical Assistance

If you have any problems installing or using this controller, please carefully and thoroughly review the instruction manual.

After service contact information on cover page of this manual.

3.2 Warranty

The supplier warrants this controller for two years (temperature and humidity probe for one year) from the date of the purchase when operated under normal condition by the original purchaser (not transferable), against defects caused by the supplier's workmanship or materials. This warranty is limited to the repair or replacement, at supplier's discretion of all or part of the controller. The original receipt is required for warranty purposes.

Part 2



IT-68

TEMPERATURE
Controller Manual

1 Get to Know the Controller

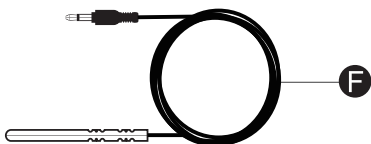
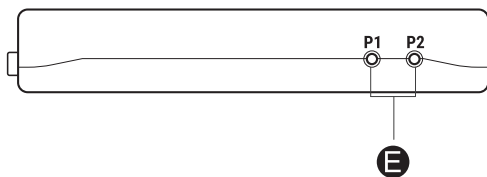
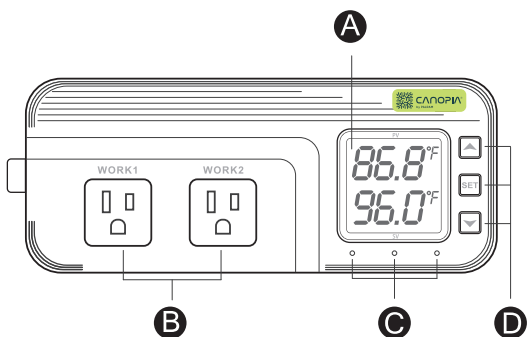

A Functions on Screen

PV: In normal mode, the measured temperature is displayed. In settings mode, it will display menu code.

SV: In normal mode, the temperature setting value is displayed. In setting mode, it will display the setting value.

B Output(WORK1/WORK2) Instruction

WORK1: The heating output

WORK2: The cooling output

C Indicator LED

- Red LED is on → WORK1 output is on.
- Green LED is on → WORK2 output is on.
- Green LED is blinking → WORK2 output is performing the function of compressor delay.
- Yellow LED is on → The controller is in the setting mode.

D Button Instruction

Please read the detail on 2.Button Operation Instructions below.

E Probe Interface

Temperature probe can be insert into P1 or P2 interface.

F Temperature Probe

● If the controller display Er, you may get a false temperature probe, please try harder to insert the probe and rotate it to make good contact. If the problem is still persists, it is likely the internal probe wire has been damaged by the moisture or heat temperature.

- The probe and cable cannot be touched by the flame.
- Do not exceed the probe temperature range to avoid damaging.

2 Button Operation Instructions

2.1 Restore Default Settings

Press the "▼" button to power on, the buzzer will make a short call, indicating that all parameters of the user's temperature probe function return to the default setting value.

2.2 "▲" and "▼" Button Function in Normal Operation Mode

Press "▲", PV shows HD, SV shows heating difference value; press "▼", PV shows CD, SV shows cooling difference value, and it will be back to the normal display if there is no operation for 3 seconds or pressing the "SET" button.

2.3 "SET" Button Function in Normal Operation Mode

Short press the "SET" button to enter the quick setting temperature value mode. SV shows the temperature setting value and flashes, and short press "▲" or "▼" button to increase or decrease the setting value, long press "▲" or "▼" button to quickly increase or decrease the setting value, finally press the "SET" button again to confirm and exit. If there is no operation, it will automatically exit after 10 seconds and save the setting value.

2.4 Button Function in Setting Mode

When the controller is working normally, press the "SET" button for 2 seconds to enter the setting mode, the PV screen shows the first menu code "TS" and the SV shows the corresponding setting value. Press "SET" button to scroll down the menu item and save the parameters of the previous menu item. Press "▲" or "▼" button to change the current setting value. If in the setting state, there is no button operation within 30 seconds or long press "SET" button for 2 seconds, exit and save the setting state, return to normal operation mode.

3 Menu Instruction

3.1 Setting Mode Flow Chart

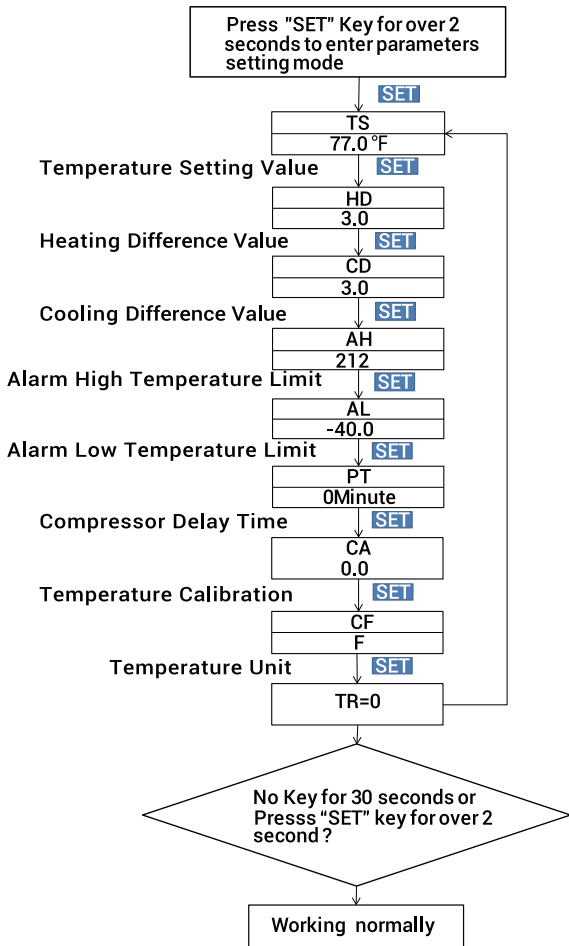

3.2 Setting Menu Instruction

Code	Symbol	Function	Setting Range	Default Settings	Annotation	
TS	ES	Temperature Setting Value	-40.0℃~100℃	25.0 ℃	More details on 4.1	
			-40.0℉~212℉	77.0 ℉		
HD	Hd	Heating Difference Value	0.3℃~15.0℃	2.0 ℃		
			1.0℉~30.0℉	3.0 ℉		
CD	Cd	Cooling Difference Value	0.3℃~15.0℃	2.0 ℃		
			1.0℉~30.0℉	3.0 ℉		
AH	AH	Alarm High Temperature Value	-40.0℃~100℃	100 ℃		More details on 4.2
			-40.0℉~212℉	212 ℉		
AL	AL	Alarm Low Temperature Value	-40.0℃~100℃	-40.0 ℃		
			-40.0℉~212℉	-40.0 ℉		
PT	PE	Compressor Delay	0 ~10 minutes	0 minute	More details on 4.3	
CA	CA	Temperature Calibration	-9.9 ℃~9.9 ℃	0.0 ℃	More details on 4.4	
			-15.0 ℉ ~15.0 ℉	0.0 ℉		
CF	CF	Fahrenheit or Celsius Setting	C or F	F	More details on 4.5	
TR	Tr	Timer Setting	0 ,1 or 2	0	More details on 4.6	

4 Control Function Instruction

When the controller works normally, the PV shows the measured temperature, meantime the SV screen shows the temperature setting value, and automatically recognizes and converts for the heating or cooling working mode , in which WORK1 is the heating output, furthermore the red led is the WORK1 heating output status indicator;WORK2 is cooling output, furthermore the green led is WORK2 cooling output status indicator.

4.1 Instructions for Setting Temperature Control (TS, HD, CD)

4.1.1 Normal Temperature Control:

When the measured temperature $PV \leq TS$ (Temperature Setting Value) – HD(Heating difference value),the controller will enter the heating state, the red led is on, WORK1 output works. When the measured temperature $PV \geq TS$ (Temperature Setting Value), the red led is off and the WORK1 output turns off.

When the measured temperature $PV \geq TS$ (Temperature Setting Value) + CD(Cooling difference value), the controller will enter the cooling state, the green led is on, WORK2 output works; the green led flashes, indicating that the cooling device is in the state of the Compressor delay protection. When PV (measured temperature) $\leq TS$ (temperature setting value),

the green led is off and the WORK2 output turns off.

For example, setting $TS=25.0^{\circ}\text{C}$, $CD=2.0^{\circ}\text{C}$, $HD=3.0^{\circ}\text{C}$, when the measured temperature value $\leq 22^{\circ}\text{C}$ ($TS-HD$), the controller will enter the heating state; when the measured temperature value $\geq 25^{\circ}\text{C}$, the heating will stop; when the measured temperature value $\geq 27.0^{\circ}\text{C}$ ($TS+CD$), the controller enter the cooling state; when measured temperature value $\leq 25.0^{\circ}\text{C}$, cooling will stop.

4.1.2 Special Temperature Control

There is no need to judge the difference value in heating or cooling when power on or exiting the setting state, it directly compare with TS (temperature setting value).

For example: When power on or exiting the setting state, $TS=25.0^{\circ}\text{C}$, $CD=2.0^{\circ}\text{C}$, $HD=3.0^{\circ}\text{C}$. If PV (measured temperature value) $>25.0^{\circ}\text{C}$, it enters the cooling state. When PV (measured temperature value) $\leq 25.0^{\circ}\text{C}$, the cooling stops. Then return to normal temperature control. When PV (measured temperature value) $<25.0^{\circ}\text{C}$, it enter the heating state, when PV (measured temperature value) $\geq 25.0^{\circ}\text{C}$, heating stops, and then return to normal temperature control.

4.2 Alarm High / Low Temperature Limit Settings (AH,AL)

When measured temperature $\geq AH$, high temperature limit alarm, then will turn off heating and cooling output, PV shows alternate AH with current temperature, buzzer will "bi-bi-Biii" alarm, until the temperature $<AH$, buzzer off and return to normal display and control. Or press any button to turn the buzzer alarm off only.

When measured temperature $\leq AL$, low temperature limit alarm, then will turn off heating and cooling output, PV shows alternate AL with current temperature, buzzer will "bi-bi-Biii" alarm, until the temperature $>AL$, buzzer off and return to normal display and control. Or press any button to turn the buzzer alarm off only.

4.3 Compressor Delay Time (PT)

In the cooling mode, when the power is turned on for the first time, $PV(\text{measured temperature value}) \geq TS(\text{Temperature setting value}) + CD(\text{Cooling difference value})$, it will not start cooling immediately, but waiting for a delay time(PT).

When two adjacent of cooling starting intervals are greater than the delay time, it will immediately start cooling; When two adjacent of cooling starting intervals are less than the delay time, it needs to operate the remaining delay time to start the cooling.

Delay time will start counting from the cooling output off.

4.4 Temperature Calibration(CA)

When the measured temperature deviates from the standard temperature, the temperature calibration function can be used to make the measured value of the instrument consistent with the standard value. The calibrated temperature=the measured temperature + the calibration value.

4.5 Fahrenheit or Celsius Settings (CF)

The users can set the display unit to Fahrenheit or Celsius according to their habits. The default temperature is Fahrenheit. If you need to display the unit in Celsius, then set the CF to C. Please note that when the CF changes state, all setting values are restored to the default setting and the buzzer gives a short beeping prompt.

4.6 Timer Setting (TR)

TR is the parameter for whether the timer function is enabled. 0 is off and 1 or 2 is on. If user set TR=1 or 2, please see **Part 3**.

Part 3

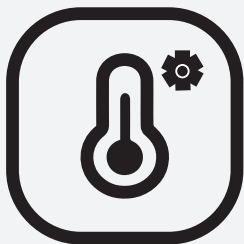

IT-68

PROGRAMMABLE
TEMPERATURE
Controller Manual

1 Get to Know the Controller

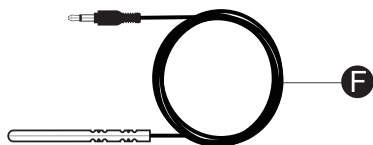
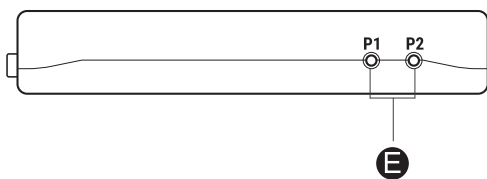
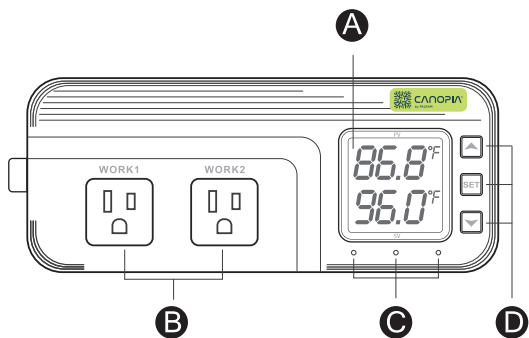

A Functions on Screen

PV: In normal mode, the measured temperature is displayed. In settings mode, it will display menu code.

SV: In normal mode, the temperature setting value is displayed. In setting mode, it will display the setting value.

B Output(WORK1/WORK2) Instruction

WORK1: The heating output

WORK2: The cooling output

C Indicator LED

- Red LED is on → WORK1 output is on.
- Green LED is on → WORK2 output is on.
- Green LED is blinking → WORK2 output is performing the function of compressor delay.
- Yellow LED is on → The controller is in the setting mode.

D Button Instruction

Please read the detail on 2.Button Operation Instructions below.

E Probe Interface

Temperature probe can be insert into P1 or P2 interface.

F Temperature Probe

- If the controller display Er, you may get a false temperature probe, please try harder to insert the probe and rotate it to make good contact. If the problem is still persists, it is likely the internal probe wire has been damaged by the moisture or heat temperature.
- The probe and cable cannot be touched by the flame.
- Do not exceed the probe temperature range to avoid damaging.

2 Button Operation Instructions

2.1 Restore Default Settings

Press the "▼" button to power on, the buzzer will make a short call, indicating that all parameters of the user's temperature probe function return to the default setting value.

2.2 Start Controlling Temperature from the First Stage Forcibly

When TR=1 or 2, press the increase button "▲" to power on, the buzzer will make a short call, indicating the user that will start controlling temperature from the first stage forcibly.

2.3 "▲" and "▼" Button Function in Normal Operation Mode

2.3.1 When TR=0

Press "▲", PV shows HD, SV shows heating difference value. Press "▼", PV shows CD, SV shows cooling difference value.

2.3.2 When TR=1 or 2

Press "▲" PV shows current time unit, SV shows the current remaining working time; And It will be back to the normal display if there is no operation for 3 seconds or pressing the "SET" button. Press "▼", PV shows the current stage, SV shows the setting value of current stage. And It will be back to the normal display if there is no operation for 3 seconds or pressing the "SET" button.

2.3.3 When TR=1 or 2

press "▲" and "▼" simultaneously for one second, it will start operating from the SST setting forcibly, at the same time, the buzzer will give a short beeping prompt.

2.4 "SET" Button Function in Normal Operation Mode

Short press the "SET" button to enter the quick setting temperature value mode. When TR=0, SV displays the temperature setting value and flashes. Short Press "▲" or "▼" button to increase or decrease the temperature

setting value. Long Press "▲" or "▲" button to quickly increase or decrease the temperature setting value, then press "SET" button to confirm and exit. When TR=1 or 2, SV shows the temperature setting value and flashes, then short press "▲" or "▼" button to increase or decrease the temperature setting value. Long press the "▲" or "▼" button to increase or decrease the temperature setting value quickly. Press the "SET" button to switch to the current stage control duration value. Short press the "▲" or "▼" button to change the current stage control duration value. Press the "SET" button to switch to whether to alarm after the completion of the current stage, then press "▲" or "▼" to modify the setting value. Press "SET" button again to confirm and exit. If there is no operation for 3 seconds, it will automatically exit after 10 seconds and save the setting value.

2.5 Button Function in Setting Mode

When the controller is working normally, press the "SET" button for 2 seconds to enter the setting mode. The PV shows the first menu code "TS", if TR=1 or 2, the PV shows the second menu code "HD", SV shows the corresponding setting value. Press "SET" button to scroll down the menu item and save the parameters of the previous menu item. Press "▲" or "▼" button to change the current setting value. If in the setting state, there is no operation within 30 seconds or long press "SET" button for 2 seconds, it will exit and save the setting state and return to normal operation mode.

3 Menu Instruction

3.1 Menu Setting Flow Chart

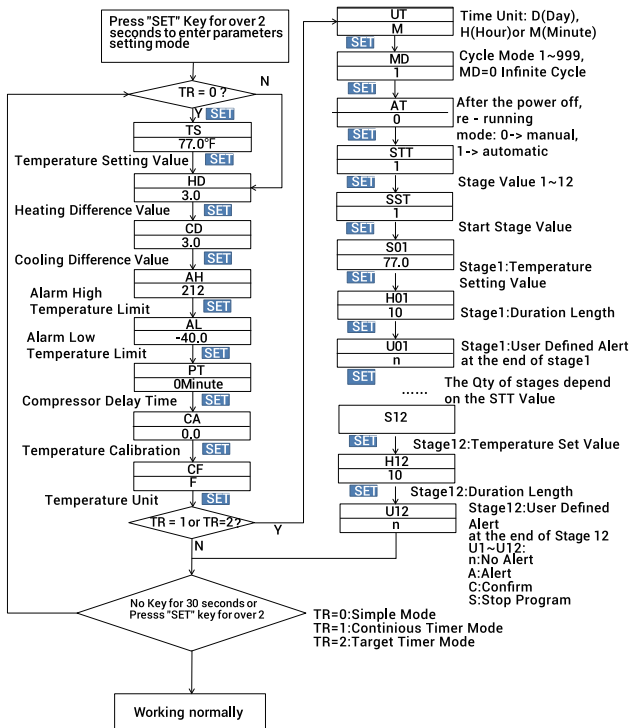

3.2 Setting Menu Instruction

Code	Symbol	Function	Setting Range	Default Settings	Annotation
TS	tS	Temperature Setting Value	-40.0℃~100℃	25.0℃	More details on 4.1
			-40.0℉~212℉	77.0℉	
HD	Hd	Heating Difference Value	0.3℃~15.0℃	2.0℃	
			1.0℉~30.0℉	3.0℉	
CD	Cd	Cooling Difference Value	0.3℃~15.0℃	2.0℃	
			1.0℉~30.0℉	3.0℉	
AH	AH	Alarm High Temperature Value	-40.0℃~100℃	100℃	More details on 4.2
			-40.0℉~212℉	212℉	
AL	AL	Alarm Low Temperature Value	-40.0℃~100℃	-40.0℃	
			-40.0℉~212℉	-40.0℉	
PT	Pt	Compressor Delay	0~10 minutes	0 minute	More details on 4.3
CA	cA	Temperature Calibration	-9.9℃~9.9℃	0.0℃	More details on 4.4
			-15.0℉~15.0℉	0.0℉	
CF	cF	Fahrenheit or Celsius Setting	C or F	F	More details on 4.5
TR	tr	Timer Setting	0, 1 or 2	0	More details on 4.6.2

3.2.1 When TR=1 or 2, When STA is Set to 12, Menu Code Setting is as Below.

Code	Symbol	Function	Setting Range	Default Settings	Annotation
UT	Ut	Time Unit Setting Value	d H n	D	d: Day, H: Hour, n: Minute
MD	nd	Cycle Setting Value	0-999	1	When is 00, infinite loop
AT	At	Auto or Manual Mode	0 or 1	0	0:Manually, 1:Automatic
STT	Stt	Time Stage Setting Value	1-12	1	More details on 4.6.4
SST	SSt	Start Stage Settings Value	1~12	1	More details on 4.6.5

3.2.2 Menu Code Setting is as Below.

Code	Symbol	Function	Default Settings	Annotation
S01	S01	Stage 1 Temperature Setting Value	25.0℃ or 77.0℉	*
H01	H01	Stage 1 Control Duration Value	10	**
U01	U01	Whether to Alarm after the Completion of Stage1	n	***
S02	S02	Stage 2 Temperature Setting Value	25.0℃ or 77.0℉	*
H02	H02	Stage 2 Control Duration Value	10	**
U02	U02	Whether to Alarm after the Completion of Stage 2	n	***
S03	S03	Stage 3 Temperature Setting Value	25.0℃ or 77.0℉	*
H03	H03	Stage 3 Control Duration Value	10	**
U03	U03	Whether to Alarm after the Completion of Stage 3	n	***
S04	S04	Stage 4 Temperature Setting Value	25.0℃ or 77.0℉	*
H04	H04	Stage 4 Control Duration Value	10	**
U04	U04	Whether to Alarm after the Completion of Stage 4	n	***
S05	S05	Stage 5 Temperature Setting Value	25.0℃ or 77.0℉	*
H05	H05	Stage 5 Control Duration Value	10	**
U05	U05	Whether to Alarm after the Completion of Stage 5	n	***
S06	S06	Stage 6 Temperature Setting Value	25.0℃ or 77.0℉	*
H06	H06	Stage 6 Control Duration Value	10	**
U06	U06	Whether to Alarm after the Completion of Stage 6	n	***
S07	S07	Stage 7 Temperature Setting Value	25.0℃ or 77.0℉	*
H07	H07	Stage7 Control Duration Value	10	**
U07	U07	Whether to Alarm after the Completion of Stage 7	n	***
S08	S08	Stage 8 Temperature Setting Value	25.0℃ or 77.0℉	*
H08	H08	Stage 8 Control Duration Value	10	**
U08	U08	Whether to Alarm after the Completion of Stage 8	n	***
S09	S09	Stage 9 Temperature Setting Value	25.0℃ or 77.0℉	*
H09	H09	Stage 9 Control Duration Value	10	**

U09	U09	Whether to Alarm after the Completion of Stage 9	n	***
S10	S10	Stage 10 Temperature Setting Value	25.0°C or 77.0°F	*
H10	H10	Stage 10 Control Duration Value	10	**
U10	U10	Whether to Alarm after the Completion of Stage 10	n	***
S11	S11	Stage 11 Temperature Setting Value	25.0°C or 77.0°F	*
H11	H11	Stage 11 Control Duration Value	10	**
U11	U11	Whether to Alarm after the Completion of Stage 11	n	***
S12	S12	Stage 12 Temperature Setting Value	25.0°C or 77.0°F	*
H12	H12	Stage 12 Control Duration Value	10	**
U12	U12	Whether to Alarm after the Completion of Stage 12	n	***

* The setting value range is the same as TS

** More details on 4.6.7

*** More details on 4.6.8

4. Control Function Instruction

When the controller works normally, the PV shows the measured temperature, meantime the SV screen shows the temperature setting value, and automatically recognizes and converts for the heating or cooling working mode, in which WORK1 is the heating output, furthermore the red led is the WORK1 heating output status indicator; WORK2 is cooling output, furthermore the green led is WORK2 cooling output status indicator.

4.1 Instructions for Setting Temperature Control (TS, HD, CD, S01~S12)

4.1.1 TR=0, Temperature Control Mode

4.1.1.1 Normal Temperature Control

When the measured temperature $PV \leq TS$ (Temperature Setting Value) – HD (Heating difference value), the controller will enter the heating state, the red led is on, WORK1 output works.

When the measured temperature $PV \geq TS$ (Temperature Setting Value), the red led is off and the WORK1 output turns off.

When the measured temperature $PV \geq TS$ (Temperature Setting Value) + CD (Cooling difference value), the controller will enter the cooling state, the green led is on, WORK2 output works; the green led flashes, indicating that the cooling device is in the state of the compressor delay protection. When PV (measured temperature) $\leq TS$ (temperature setting value), the green led is off and the WORK2 output turns off.

For example, setting $TS=25.0^{\circ}\text{C}$, $CD=2.0^{\circ}\text{C}$, $HD=3.0^{\circ}\text{C}$, when the measured temperature value $\leq 22^{\circ}\text{C}$ ($TS-HD$), the controller will enter the heating state; when the measured temperature value $\geq 25^{\circ}\text{C}$, the heating will stop; when the measured temperature value $\geq 27.0^{\circ}\text{C}$ ($TS+CD$), the controller enter the cooling state; when measured temperature value $\leq 25.0^{\circ}\text{C}$, cooling will stop;

4.1.1.2 Special Temperature Control

When $TR=0$, there is no need to judge the difference value in heating or cooling when power on or exiting the setting state, it directly compare with TS (temperature setting value).

For example: When power on or exiting the setting state, $TS=25.0^{\circ}\text{C}$, $CD=2.0^{\circ}\text{C}$, $HD=3.0^{\circ}\text{C}$. If PV (measured temperature value) $>25.0^{\circ}\text{C}$, it enters the cooling state. When PV (measured temperature value) $\leq 25.0^{\circ}\text{C}$, the cooling stops. Then return to normal temperature control. When PV (measured temperature value) $<25.0^{\circ}\text{C}$, it enter the heating state, when PV (measured temperature value) $\geq 25.0^{\circ}\text{C}$, heating stops, and then return to normal temperature control.

4.1.2 When $TR=1$ or 2 , Timer Mode

The TS (temperature setting value) will be invalid. The controller will execute commands according to the setting values of $S01\sim S12$, the setting value of $H01\sim H12$, and the setting value of $U01\sim U12$.

About how to set the time and control temperature, please refer to 6.6

4.2 Alarm High / Low Temperature Limit Settings (AH,A)

When measured temperature $\geq AH$, high temperature limit alarm, PV shows alternate AH with current temperature, buzzer will "bi-bi-Biii" alarm, until the temperature $<AH$, buzzer off and return to normal display and control. Or press any button to turn the buzzer alarm off only.

When measured temperature $\leq AL$, low temperature limit alarm, PV shows alternate AL with current temperature, buzzer will "bi-bi-Biii" alarm, until the temperature $>AL$, buzzer

off and return to normal display and control. Or press any button to turn the buzzer alarm off only.

4.3 Compressor Delay Time(PT)

In the cooling mode, when the power is turned on for the first time, $PV(\text{measured temperature value}) \geq TS(\text{Temperature setting value}) + CD(\text{Cooling difference value})$, it will not start cooling immediately, but waiting for a delay time(PT).

When two adjacent of cooling starting intervals are greater than the delay time, it will immediately start cooling; When two adjacent of cooling starting intervals are less than the delay time, it needs to operate the remaining delay time to start the cooling.

Delay time will start counting from the cooling output off.

4.4 Temperature Calibration(CA)

When the measured temperature deviates from the standard temperature, the temperature calibration function can be used to make the measured value of the instrument consistent with the standard value. The calibrated temperature=the measured temperature + the calibration value.

4.5 Fahrenheit or Celsius Settings (CF)

The users can set the display unit to Fahrenheit or Celsius according to their habits. The default temperature is Fahrenheit. If you need to display the unit in Celsius, then set the CF to C. Please note that when the CF changes state, all setting values are restored to the default setting and the buzzer gives a short beeping prompt.

4.6 Time-Temperature Setting Values Execution Cycle Times MD and Time-Temperature Parameter Settings (TR,UT,STT,SST,S01~S12,H01~H12,U01~U12)

4.6.1 MD is the execution times of the time-temperature setting value. From the SST setting value to the last stage setting value of STT, it is a cycle. If MD=0 represents an infinite loop, MD=1~999 represents the specific times of cycle execution. The default value of MD is 1. Under the condition of MD=1~999, after the corresponding execution cycles is

completed, the detailed status is described in 6.4.6.8.

4.6.2 TR is the parameter for whether the timer function is enabled. 0 is off and 1 or 2 is on.

4.6.2.1 TR=0, Temperature Control Mode The timer function will not start, all the setting parameters after the parameter TR will not show in the menu, and there is no need to set.

4.6.2.2 TR=1 Continuous Timer Mode & TR=2 Target Timer Mode

The user is required to set the time and corresponding temperature control parameters, at this time, TS(temperature setting value) will be invalid, the system will control according to the temperature of the time period.

Regarding the difference between TR=1(Continuous Timer Mode) and TR=2(Target Timer Mode), the following table illustrates their differences in details.

Stage X(N=1~12)	STX(X=1~12)(°C)	HTX(X=1~12)(Minutes)	UAX(X=1~12)
Stage1	20.0	10	n
Stage2	30.0	7	n
Stage3	35.0	12	n

Different reaction times are obtained, as shown in the following table:

Time [minutes]	TR = 1 Continuous Timer mode		TR = 2 Target Timer mode	
	Temp[°C]	Stage	Temp[°C]	Stage
0	10	1	10	
1	12	1	12	
2	14	1	14	
3	16	1	16	
4	18	1	18	
5	20	1	20	1
6	20	1	20	1
7	20	1	20	1
8	20	1	20	1
9	20	1	20	1
10	20	1	20	1
11	22	2	20	1
12	24	2	20	1
13	26	2	20	1
14	28	2	20	1
15	30	2	22	
16	30	2	24	
17	30	2	26	
18	32	3	28	
19	34	3	30	2
20	35	3	30	2
21	35	3	30	2
22	35	3	30	2
23	35	3	30	2
24	35	3	30	2
25	35	3	30	2
26	35	3	32	

27	35	3	34	
28	35	3	35	3
29	35	3	35	3
30			35	3
31			35	3
32			35	3
33			35	3
34			35	3
35			35	3
36			35	3
37			35	3
38			35	3
39			35	3

The above table is the difference between the continuous timer mode and the target timer mode of the thermostat, which is represented by the curve image as follows:

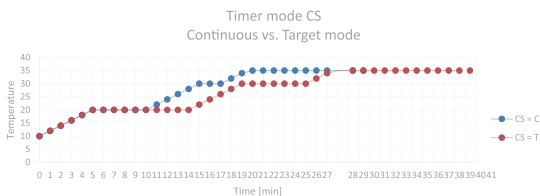

From the graph, we can see that when TR=1, the continuous timer mode (the blue line), the stage control time H01~H03 is continuous time, 0...10, 11...17, 18...29, total is 29 minutes; When TR=2, the target timer mode (the red line), the stage control time H01~H03 is only started when the current temperature reaches the setting temperature of the current stage, such as 5...14, 19...25, 32...35, and total is 39 minutes.

4.6.3 UT is a time unit setting parameter, and the user can set the time unit to days, hours or minutes as required.

4.6.4 STT is the setting stages of the time – temperature period. Users can set different time periods to control different temperature according to their needs. At most 12 time periods can be set to control 12 different temperature.

4.6.5 SST is the beginning stage of time - temperature period. Users can select which stage to start control according to their own requirements.

4.6.6 S01~S12 are temperature setting parameters. When TR=1 or 2, the setting value of ST1~ST12 will replace the TS value as the condition parameter of temperature control.

4.6.7 H01~H12 are duration parameters, and the current

stage will not enter the next time-temperature control until the current stage is completed.

4.6.8 U01~U12 are the parameters for the user to determine whether to alarm or not, setting to n=No Alarm; A= Alarm; C= Confirm; S=Stop Program.

4.6.8.1 UX=n: If the current stage is set to n, the next cycle control is entered; if the execution of the cycle index MD is completed, all output controls are turned off, PV shows the current temperature, and SV shows End.

4.6.8.2 UX=A: If the current stage is set to A, when the duration is completed, enter the next stage of control, PV shows the previous stage UX (X = 01~12), SV shows A, and PV shows the current temperature, SV shows the current stage of setting temperature with 1Hz frequency alternate, buzzer beeps every two seconds; if the cycle index MD is completed, all output control is turned off, PV shows previous stage UX (X=01~12), SV shows A and PV shows current temperature, SV shows End with 1Hz frequency alternately . Press any button at this time to cancel the buzzer alarm and return to normal display. If the cycle index MD is completed, PV will show the current temperature and SV will show End.

4.6.8.3 UX=C: If the current stage is set to C, when the duration is completed, it still control according to the current stage of the set temperature, PV shows the current stage UX (X = 01 ~ 12), SV shows C, and PV shows the current temperature, SV shows the current stage temperature setting value with 1Hz frequency alternately . The buzzer beeps every two seconds. Only when the user presses any button will turn the alarm off and the control will be entered in the next stage. If the execution of the cycle index MD is completed, PV shows the current temperature and SV shows End.

4.6.8.4 UX=S: If the current stage is set to S, when the duration is completed, all output controls are turned off, PV shows the current stage UX (X=01~12), S shows down, and PV shows the current temperature, SV shows the current stage temperature setting value with 1Hz frequency alternately, the buzzer beeps every two seconds. Only when the user presses any button will turn the alarm off and the

control will be entered in the next stage. If the execution of the cycle index MD is completed, PV shows the current temperature and SV shows End.

4.7 Manual or Automatic Mode (AT)

AT is the power on operation mode after power off.

AT=0:Manual Mode, after power off to re-power, the temperature controller will stop working, PV display flicker, buzzer will beep every one second, prompting the user to reset the parameters, after saving and exiting, the temperature controller restart the work.

AT=1:Automatic Mode, after the power is turned off, the time still counts. After the power is turned on again, when TR=1 and UX (X=01~12) is n or A, the temperature controller will automatically calculate the time from the power off to the power on and operate to the corresponding stage, according to the operating time of H01~H12 and the operating state of the U01~U12. For example TR=1, Stage1 S01=25.0°C, H01=4H, U01=n, Stage2 S02=30.0°C, H02=6H, U02=A; when the temperature controller executes stage1 for 2 hours, and power off for 3 hours, at this point, the temperature controller will execute 2+3=5 hours by default, and the temperature controller will execute stage2 with only 5 hour remaining.

Part 4

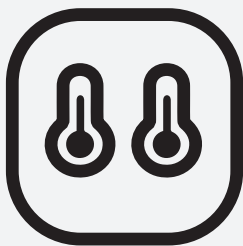

IT-68

DUAL TEMPERATURE
PROBES

Controller Manual

(not included)

1 Get to Know the Controller

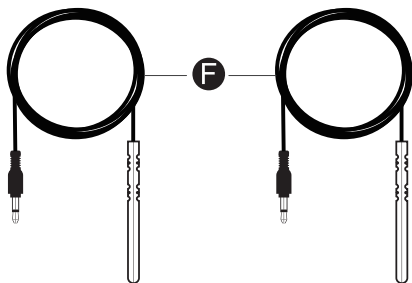
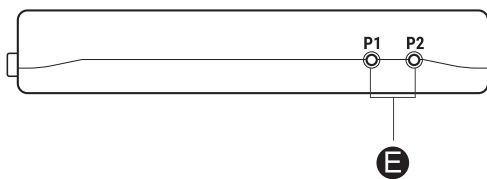
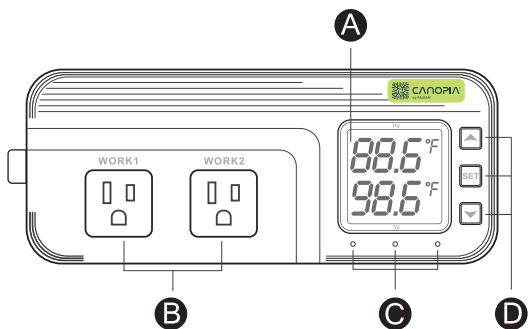

A Functions on Screen

PV: In normal mode, the P1 measured temperature is displayed. In settings mode, it will display menu code.

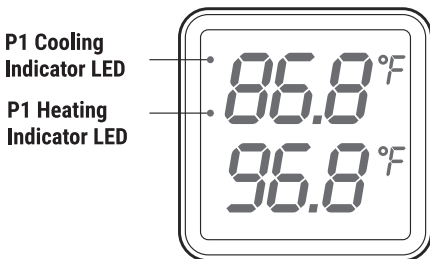

P1 Heating Indicator LED: If P1 Temperature Control Function selected heating mode, the indicator LED is on, otherwise off.

P1 Cooling Indicator LED: If P1 Temperature Control Function selected cooling mode, the indicator LED is on, otherwise off.

SV: In normal mode, the P2 measured temperature is displayed. In setting mode, it will display the setting value.

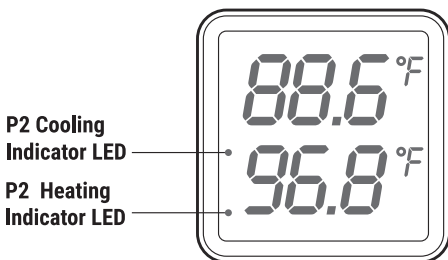

P2 Heating Indicator LED: If P2 Temperature Control Function selected heating mode, the indicator LED is on, otherwise off.

P2 Cooling Indicator LED: If P2 Temperature Control Function selected cooling mode, the indicator LED is on, otherwise off.

B Output(WORK1/WORK2)Instruction

WORK1: The P1 heating/cooling output

WORK2: The P2 heating/cooling output

C Indicator LED

- Red LED is on → WORK1 output is on.
- Red LED is blinking → WORK1 output is performing the function of compressor delay.
- Green LED is on → WORK2 output is on.
- Green LED is blinking → WORK2 output is performing the function of compressor delay.
- Yellow LED is on → The controller is in the setting mode.

D Button Instruction

Please read the detail on 2.Button Operation Instructions below.

E Probe Interface

Two temperature probes can be insert into P1 and P2 interface.

F Temperature Probe

- If the controller display Er, you may get a false temperature probe, please try harder to insert the probe and rotate it to make good contact. If the problem is still persists, it is likely the internal probe wire has been damaged by the moisture or heat temperature.
- The probe and cable cannot be touched by the flame.
- Do not exceed the probe temperature range to avoid damaging.

2 Button Operation Instructions

2.1 Restore Default Data

Press the "▼" button to power on, the buzzer will make a short call, indicating that all parameters of both temperature probes function return to the default setting value.

2.2 Button Function in Normal Operation Mode

Press "▲", PV shows temperature setting value of probe 1, it will be back to the normal display if there is no operation for 3 seconds or pressing the "SET" button. Press "▼", SV shows temperature setting value of probe 2, and it will be back to the normal display if there is no operation for 3 seconds or pressing the "SET" button.

2.3 Tap "SET" button to enter the mode for setting temperature value. SV shows the temperature setting value of probe 1 and flashes, at this time quickly press "▲" or "▼" button to increase or decrease the setting value, long press "▲" or "▼" button to quickly increase or decrease the setting value; and then press "SET" again, SV shows the temperature setting value of probe 2 and flashes, at this time quickly press "▲" or "▼" button to increase or decrease the setting value, long press "▲" or "▼" button to quickly increase or decrease the setting value, finally press the "SET" button again to confirm and exit. If there is no operation, it will automatically exit after 10 seconds and save the setting value.

2.4 Dual Temperature Probes Function Setting

When the controller is working normally, press and hold the "SET" button for 2 seconds to enter the setting mode. PV shows the code "CF" of the first menu item, and SV shows the corresponding setting value. Press the "SET" button to scroll down the menu item and save the parameters of the previous menu item. Press the "UP" or "DOWN" button to change the current setting value. If there is no button operation within 30 seconds or long press "SET" button for 2 seconds in the setting state, it will save the parameters and exit the setting state, then return to the normal working mode.

3 Menu Instruction

3.1 Menu Setting Flow Chart

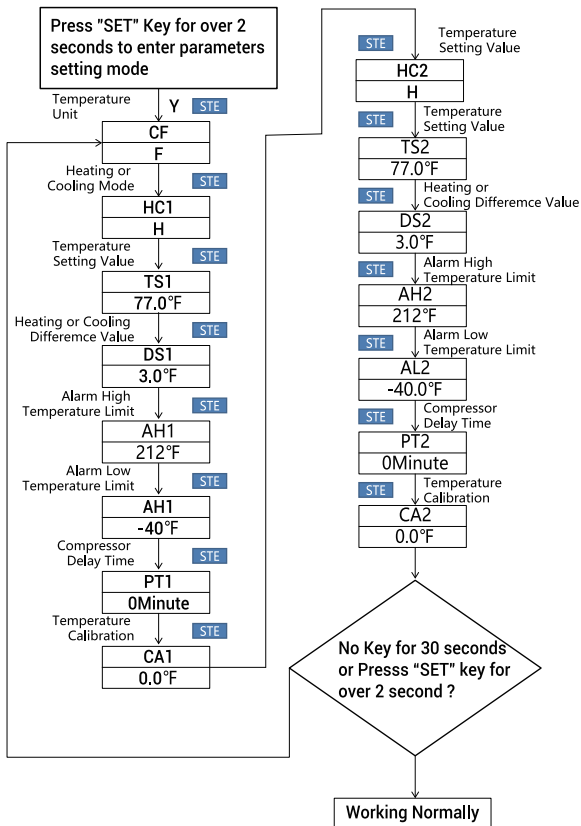

3.2 Dual Temperature Probes Setup Menu Description

Code	Symbol	Menu Function	Setting Range	Default Setting	Default Setting
CF	CF	Fahrenheit or Celsius Setting	C or F	F	
HC1	HC1	Heating or Cooling Setting	H or C	H	
TS1	TS1	Temperature Setting	-40.0°C ~ 120°C	25.0°C	
			-40.0°F ~ 248°F	77.0°F	The minimum unit is 1°F
DS1	DS1	Setting Value for Heating or Cooling Difference	0.3°C ~ 15.0°C	2.0°C	
			0.5°F ~ 30.0°F	3.0°F	
AH1	AH1	High Temperature Alarm	-40.0°C ~ 100°C	100°C	
			-40.0°F ~ 212°F	212°F	The minimum unit is 1°F
AL1	AL1	Low Temperature Alarm	-40.0°C ~ 100°C	-40.0°C	
			-40.0°F ~ 212°F	-40.0°F	The minimum unit is 1°F
PT1	PT1	Compressor Delay Time	0 ~ 10 minute	0 minute	
CA1	CA1	Temperature Calibration	-9.9°C ~ 9.9°C	0.0°C	
			-15.0°F ~ 15.0°F	0.0°F	
HC2	HC2	Heating or Cooling Setting	H or C	H	
TS2	TS2	Temperature Setting	-40.0°C ~ 100°C	25.0°C	
			-40.0°F ~ 212°F	77.0°F	The minimum unit is 1°F
DS2	DS2	Setting Value for Heating or Cooling Difference	0.3°C ~ 15.0°C	2.0°C	
			0.5°F ~ 30.0°F	3.0°F	
AH2	AH2	High Temperature Alarm	-40.0°C ~ 100°C	100°C	
			-40.0°F ~ 212°F	212°F	The minimum unit is 1°F
AL2	AL2	Low Temperature Alarm	-40.0°C ~ 100°C	-40.0°C	
			-40.0°F ~ 212°F	-40.0°F	The minimum unit is 1°F
PT2	PT2	Compressor Delay Time	0 ~ 10minute	0 minute	
CA2	CA2	Temperature Calibration	-9.9°C ~ 9.9°C	0.0°C	
			-15.0°F ~ 15.0°F	0.0°F	

4. Dual Temperature Probes Control Function Description

When the controller is working normally, PV shows the current temperature of probe 1, P1 Heating indicator LED and P1 Cooling indicator LED will prompt the user whether the heating or cooling function is selected; SV shows the current temperature of probe 2, P2 Heating indicator LED and P2 Cooling indicator LED will prompt the user whether the heating or cooling function is selected, wherein WORK1 is the output control of the probe 1, the red indicator light is the WORK1 probe 1 output state indicator, and the WORK2 is the output control of the probe 2, the green indicator light is the

WORK2 probe 2 output state indicator.

4.1 Control Function of Probe 1

When HC1=H, the temperature mode is heating mode, PV LED 1 is on, and when the measured temperature \leq temperature setting value TS1 - difference value DS1, it enters the heating state, the WORK1 indicator is on, and the WORK1 relay works. When the measured temperature \geq temperature setting value TS1, the WORK1 indicator is off and the WORK1 relay is off.

When HC1=C, the temperature mode is cooling mode, PV LED 2 is on, and when the measured temperature \geq temperature setting value TS1 + difference value DS1, it enters the cooling state, the WORK1 indicator is on, and the WORK1 relay works; the WORK1 indicator flashes, it means that the cooling device is in the delayed protection state. When the measured temperature \leq temperature setting value TS1, the WORK1 indicator is off and the WORK1 relay is off.

4.2 Control Function of Probe 2

When HC2=H, the temperature mode is heating mode, SV LED1 is on, and when the measured temperature \leq temperature setting value TS2 - difference value DS2, it enters the heating state, the WORK2 indicator is on, and the WORK2 relay works. When the measured temperature \geq temperature setting value TS2, the WORK2 indicator is off and the WORK2 relay is off.

When HC2=C, the temperature mode is cooling mode, SV LED 2 is on, and when the measured temperature \geq temperature setting value TS2 + difference value DS2, it enters the cooling state, the WORK2 indicator is on, and the WORK2 relay works; the WORK2 indicator flashes, it means that the cooling device is in the delayed protection state. When the measured temperature \leq temperature setting value TS2, the WORK2 indicator is off and the WORK2 relay is off.

4.3 High/Low Temperature Alarm Settings

(AH1,AL1,AH2,AL2)

4.3.1 High/Low Temperature Alarm Settings of Probe 1

When measured temperature \geq high temperature setting value AH1, it will alarm, PV shows alternate AH1 with current temperature, buzzer will "bi-bi-Biii" alarm, until the tempera-

ture < high temperature setting value AH1, buzzer off and return to normal display and control. Or press any button to turn the buzzer alarm off only.

When measured temperature \leq low temperature setting value AL1, it will alarm, PV shows alternate AL1 with current temperature, buzzer will "bi-bi-Biii" alarm, until the temperature >AL1, buzzer off and return to normal display and control. Or press any button to turn the buzzer alarm off only.

4.3.2 High/Low Temperature Alarm Settings of Probe 2

When measured temperature \geq high temperature setting value AH2, it will alarm, SV shows alternate AH2 with current temperature, buzzer will "bi-bi-Biii" alarm, until the temperature < high temperature setting value AH2, buzzer off and return to normal display and control. Or press any button to turn the buzzer alarm off only.

When measured temperature \leq low temperature setting value AL2, it will alarm, PV shows alternate AL2 with current temperature, buzzer will "bi-bi-Biii" alarm, until the temperature >AL2, buzzer off and return to normal display and control. Or press any button to turn the buzzer alarm off only.

5.1 Compressor Delay Time (PT1,PT2)

In the cooling mode, when the power is turned on for the first time, if measured temperature value \geq Temperature setting value + difference value, it will not start cooling immediately until the delay time is running out.

When two adjacent of cooling starting intervals are greater than the delay time, it will immediately start cooling; When two adjacent of cooling starting intervals are less than the delay time, it needs to operate the remaining delay time to start the cooling.

Delay time will start counting from the cooling output off.

5.2 Temperature Calibration (CA1,CA2)

When the measured temperature deviates from the standard temperature, the temperature calibration function can be used to make the measured value of the instrument consistent with the standard value. The temperature value after calibrating = the measured temperature + the calibration value.

5.3 Fahrenheit or Celsius Settings (CF)

The users can set the display unit to Fahrenheit or Celsius according to their habits. The default temperature is Fahrenheit. If you need to display the unit in Celsius, then set the CF to C. Please note that when the CF changes state, all setting values are restored to the default setting and the buzzer gives a short beeping prompt.

Part 5



IT-68

HUMIDITY Controller Manual

1 Get to Know the Controller

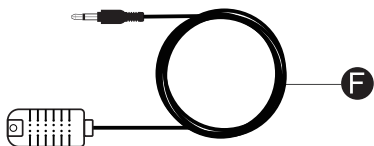
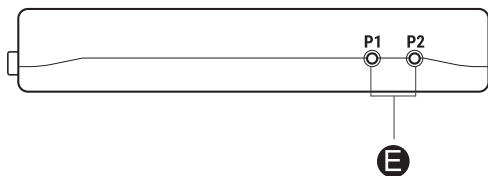
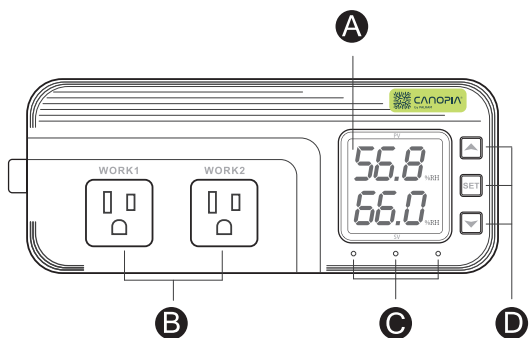

A Functions on Screen

PV: In normal mode, the measured humidity is displayed. In settings mode, it will display menu code.

SV: In normal mode, the humidity setting value is displayed. In setting mode, it will display the setting value.

B Output(WORK1/WORK2) Instruction

WORK1: The humidification output

WORK2: The dehumidification output

C Indicator LED:

- Red LED is on → WORK1 output is on.
- Green LED is on → WORK2 output is on.
- Green LED is blinking → WORK2 output is performing the function of compressor delay.
- Yellow LED is on → The controller is in the setting mode.

D Button Instruction

Please read the detail on 2.Button Operation Instructions below

E Probe Interface

Humidity probe can be insert into P1 or P2 interface.

F humidity Probe

- If the controller display Er, you may get a false humidity probe, please try harder to insert the probe and rotate it to make good contact. If the problem is still persists, it is likely the internal probe wire has been damaged by the moisture or heat temperature.
- The probe and cable cannot be touched by the flame.
- Do not exceed the probe humidity or temperature range to avoid damaging.

2 Button Operation Instructions

2.1 Restore Default Settings

Press "▼" button to power on, the buzzer will make a short call, indicating that all parameters of the user's humidity probe function return to the default setting value.

2.2 "▲" and "▼" Button Function in Normal Operation Mode

Press "▲", PV shows HD, SV shows humidification difference value; press "▼", PV shows DD, SV shows dehumidification difference value, and it will be back to the normal display if there is no operation for 3 seconds or pressing the "SET" button.

2.3 "SET" Button Function in normal operation mode

Short press the "SET" button to enter the quick setting humidity setting value mode. SV shows the humidity value and flashes, and short press "▲" or "▼" button to increase or decrease the setting value, long press "▲" or "▼" button to quickly increase or decrease the setting value, and press the "SET" button again to confirm and exit. If there is no operation, it will automatically exit after 10 seconds and save the setting value.

2.4 Button Function in Setting Mode

When the controller is working normally, press the "SET" button for 2 seconds to enter the setting mode, the PV screen shows the first menu code "HS" and the SV shows the corresponding setting value. Press "SET" button to scroll down the menu item and save the parameters of the previous menu item. Press "▲" or "▼" button to change the current setting value. If in the setting state, there is no button operation within 30 seconds or long press "SET" button for 2 seconds, exit and save the setting state, return to normal operation mode.

3. Menu Instruction

3.1 Setting mode Flow Chart

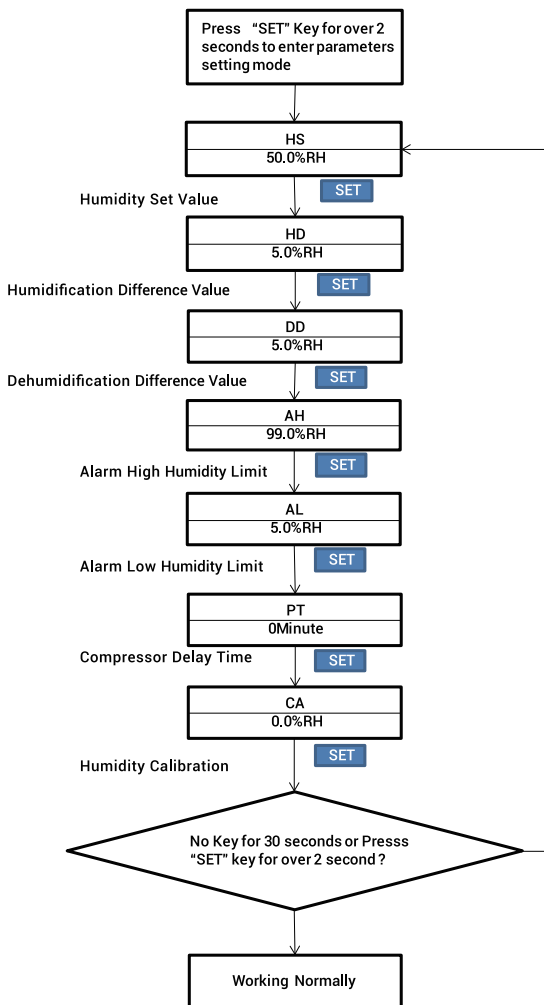

3.2 Setting Menu Instruction

Code	Symbol	Function	Setting Range	Default Setting
HS	<i>HS</i>	Humidity Setting Value	5.0%RH ~99.0%RH	50.0%RH
HD	<i>Hd</i>	Humidification Difference Value	1.0%RH ~20.0%RH	5.0%RH
DD	<i>dd</i>	Dehumidification Difference Value	1.0%RH ~20.0%RH	5.0%RH
AH	<i>AH</i>	Alarm High Humidity Limit	5.0%RH ~99.0%RH	99.0%RH
AL	<i>AL</i>	Alarm Low Humidity Limit	5.0%RH ~99.0%RH	5.0%RH
PT	<i>Pt</i>	CompressorDelay Time	0~10 minutes	0 minute
CA	<i>CA</i>	Humidity Calibration	-20.0%RH ~20.0%RH	0.0%RH

4.Control Function Instruction

4.1 Setting Humidity Control Function (HS ,HD, DD)

When the controller works normally, PV shows the measured humidity, meantime SV shows the humidity setting value, and automatically recognizes and converts for the humidification and dehumidification working mode .WORK1 is the humidification output, furthermore the red led is the WORK1 humidification output status indicator; WORK2 is dehumidification output, furthermore the green led is WORK2 dehumidification output status indicator.

When $PV(\text{measured humidity}) \leq HS(\text{humidity setting value}) - HD(\text{humidification difference value})$, the controller will enter into the humidification state, the red led is on, WORK1 output works. When $PV(\text{measured humidity}) \geq HS(\text{humidity setting value})$, the red led is off and the WORK1 output turns off.

When $PV(\text{measured humidity}) \geq HS(\text{humidity setting value}) + DD(\text{dehumidification difference value})$, the controller will enter into the dehumidification state, the green led is on, WORK2 output works; green led flashes, indicating that the dehumidification device is in delay protection state. When $PV(\text{measured humidity}) \leq HS(\text{humidity setting value})$, the green led is off and the WORK2 output turns off.

For example, when setting $HS=50.0\%RH$, $DD=5.0\%RH$, $HD=8.0\%RH$, measured humidity value $\geq 55.0\%RH(HS+DD)$, the controller will enter the dehumidification state, when measured humidity value $\leq 50.0\%RH$, dehumidification will

stop; When the measured humidity value is $\leq 42\%RH$ (HS-HD), the controller will enter the humidification state, and when the measured humidity value is $\geq 50\%RH$, the humidification will stop.

4.2 Alarm High / Low Humidity Limit Settings (AH,AL)

When measured humidity $\geq AH$ (alarm high humidity limit), PV shows alternate AH with measured humidity, buzzer will "bi-bi-Biii" alarm, until the humidity $<AH$, buzzer off and return to normal display and control. Or press the button to turn the buzzer alarm off only.

When measured humidity $\leq AL$ (alarm low humidity limit),PV shows alternate AL with measured humidity, buzzer will "bi-bi-Biii" alarm, until the humidity $<AL$, buzzer off and return to normal display and control. Or press the button to turn the buzzer alarm off only.

4.3 Dehumidifying Delay Protection Time (PT)

In the dehumidifying mode, when the power is turned on for the first time, it will not start dehumidification immediately when PV(measured humidity value) $\geq HS$ (humidity setting value)+ DD(dehumidification difference setting value),but waiting for a delay time(PT).

When two adjacent of dehumidification starting intervals are greater than the delay time, it will immediately start dehumidification ; When two adjacent of dehumidification starting intervals are less than the delay time, it needs to operate the remaining delay time to start the dehumidification Delay time will start counting from the dehumidification output off.

4.4 Humidity Calibration (CA)

When the measured humidity deviates from the standard humidity, the humidity calibration function can be used to make the measured value of the instrument consistent with the standard value. The calibrated humidity = the measured humidity value + the calibration value.

Part 6



IT-68

**TEMPERATURE &
HUMIDITY**

Controller Manual

1 Get to Know the Controller

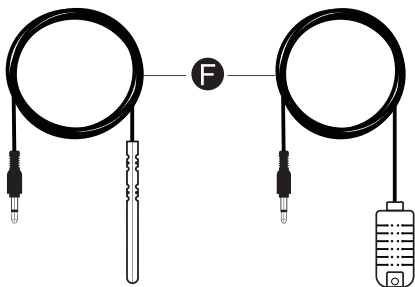
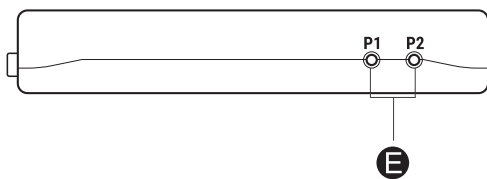
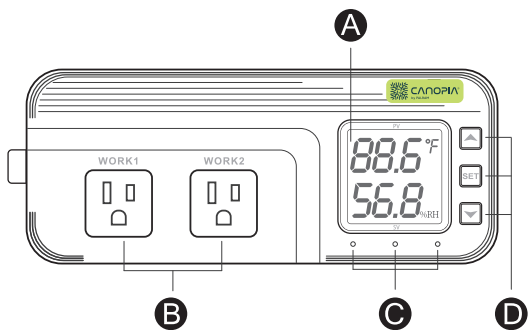

A Functions on Screen

PV: In normal mode, the measured temperature is displayed. In settings mode, it will display menu code.

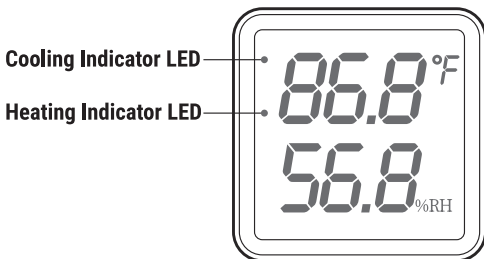

Heating Indicator LED: If Temperature Control Function selected heating mode, the indicator LED is on, otherwise off.

Cooling Indicator LED: If Temperature Control Function selected cooling mode, the indicator LED is on, otherwise off.

SV: In normal mode, the measured humidity is displayed. In setting mode, it will display the setting value.

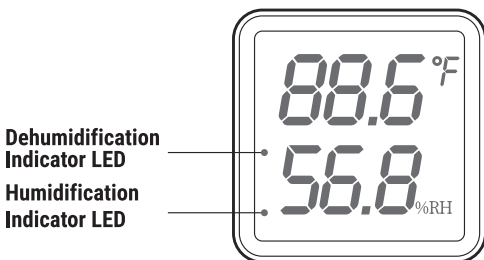

Humidification Indicator LED: If humidity Control Function selected humidification mode, the indicator LED is on, otherwise off.

Dehumidification Indicator LED: If humidity Control Function selected dehumidification mode, the indicator LED is on, otherwise off.

B Output(WORK1/WORK2)Instruction

WORK1: The heating/cooling output

WORK2: The humidification/dehumidification output

C Indicator LED

- Red LED is on → WORK1 output is on.
- Red LED is blinking → WORK1 output is performing the function of compressor delay.
- Green LED is on → WORK2 output is on.
- Green LED is blinking → WORK2 output is performing the function of compressor delay.
- Yellow LED is on → The controller is in the setting mode.

D Button Instruction

Please read the detail on 2.Button Operation Instructions below

E Probe Interface

Temperature or humidity probe can be insert into P1 or P2

F Temperature & Humidity Probe

- If the controller display Er, you may get a false temperature or humidity probe, please try harder to insert the probe and rotate it to make good contact. If the problem is still persists, it is likely the internal probe wire has been damaged by the moisture or heat temperature.
- The probe and cable cannot be touched by the flame.
- Do not exceed the probe temperature or humidity range to avoid damaging.(-40 °C~100 °C(-40 °F~212 °F)/5%~99%RH)

2 Button Operation Instructions

2.1 Restore Default Settings

Press and hold the "▼" button to power on, the buzzer will make a short call, indicating that all parameters of the user's temperature and humidity probe function return to the default setting value.

2.2 "▲" and "▼" Button Function in Normal Operation Mode

Press the "▲", PV shows the current temperature setting value, SV shows current humidification value; press "▼", PV shows current temperature value, SV the current humidification setting value, and It will be back to the normal display if there is no operation for 3 seconds or pressing the "SET" button.

2.3 "SET" Button Function in Normal Operation Mode

Short press the "SET" button to enter the quick setting temperature and humidity value mode. PV shows the current temperature setting value and flashes, and short press "▲" or "▼" button to increase or decrease the setting value, long press "▲" or "▼" button to quickly increase or decrease the setting value, Short press the "SET" button again, SV shows the current humidity setting value and flashes, and short press "▲" or "▼" button to increase or decrease the setting value, long press "▲" or "▼" button to quickly increase or decrease the setting value and lastly press the "SET" button again to confirm and exit. If there is no operation, it will automatically exit after 10 seconds and save the setting value.

2.4 Button Function in Setting Mode

When the controller is working normally, press the "SET" button for 2 seconds to enter the setting mode, the PV shows the first menu code "nd", SV shows the corresponding setting value. Press "SET" button to scroll down the menu item and save the parameters of the previous menu item. Press "▲" or "▼" button to change the current setting value. Selected T to enter the temperature parameter modification mode; selected H to enter the humidity parameter modification mode. If in the setting state, there is no operation within 30 seconds or long press "SET" button for 2 seconds, it will exit and save the setting state and return to normal operation mode.

3 Menu Instruction

3.1 Setting Mode Flow Chart

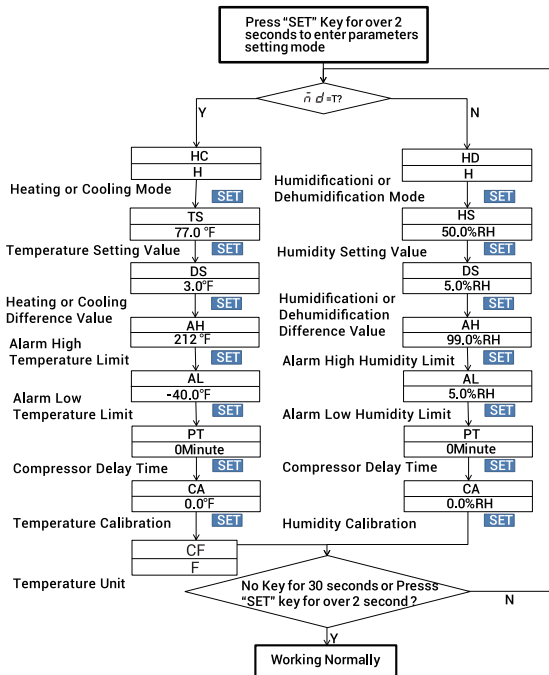

3.2 Setting Menu Instruction

3.21 When $\bar{n}d$ is H

Code	Symbol	Function	Setting Range	Default Setting
HD	$\bar{H}d$	Humidification or Dehumidification Mode	H or D	H
HS	$\bar{H}S$	Humidity Setting Value	5.0%RH ~99.0%RH	50%RH
DS	$\bar{d}S$	Humidification or Dehumidification Difference Value	1.0%RH ~20.0%RH	5%RH
AH	$\bar{A}H$	Alarm High Humidity Limit	5.0%RH ~99.0%RH	99.0%RH
AL	$\bar{A}L$	Alarm Low Humidity Limit	5.0%RH ~99.0%RH	5.0%RH
PT	$\bar{P}t$	Compressor Delay Time	0~10 minutes	0 minute
CA	$\bar{C}A$	Humidity Calibration	-20.0%RH ~20.0%RH	0%RH

3.3.2 When $\bar{n} d$ is T

Code	Symbol	Function	Setting Range	Default Setting
HC	$H\bar{C}$	Heating or Cooling mode	H or C	H
TS	$\bar{T}S$	Temperature Setting Value	-40.0°C ~ 100°C	25.0°C
			-40.0°F ~ 212°F	77.0°F
DS	$\bar{D}S$	Heating or Cooling Difference Value	0.3°C ~ 15.0°C	2.0°C
			1.0°F ~ 30.0°F	3.0°F
AH	$\bar{A}H$	Alarm High Temperature Limit	-40.0°C ~ 100°C	100°C
			-40.0°F ~ 212°F	212°F
AL	$\bar{A}L$	Alarm Low Temperature Limit	-40.0°C ~ 100°C	-40.0°C
			-40.0°F ~ 212°F	-40.0°F
PT	$\bar{P}T$	Compressor Delay Time	0 ~ 10 minutes	0 minute
CA	$\bar{C}A$	Temperature Calibration	-9.9°C ~ 9.9°C	0.0°C
			-15.0°F ~ 15.0°F	0.0°F
CF	$\bar{C}F$	Fahrenheit or Celsius Settings	C or F	F

4. Control Function Instruction

When the controller is working normally, the PV displays the measured temperature. Use Heating indicator LED and Cooling indicator LED to indicate whether the user has chosen heating or cooling. The SV displays the measured humidity. Use Humidification indicator LED and Dehumidification indicator LED to indicate whether the user has chosen humidification or dehumidification. The WORK1 is output control of Temperature, furthermore the red led is the WORK1 output status indicator; the WORK2 is the output control of humidity, furthermore the green led is the WORK2 output status indicator.

4.1 Temperature Control Function (HC, TS, DS)

When HC=H, it is heating mode, Heating indicator LED is on. When $PV(\text{measured temperature}) \leq TS(\text{temperature setting value}) - DS(\text{heating or cooling difference setting value})$, red led is on, WORK1 output works; when $PV(\text{measured temperature}) \geq TS(\text{temperature setting value})$, red led is off, and the WORK1 output is off.

When HC=C, it is cooling mode, Cooling indicator LED is on. When $PV(\text{measured temperature}) \geq TS(\text{temperature setting value}) + DS(\text{heating or cooling difference setting value})$, red led is on, and the WORK1 output works; red led flashes, indicating the cooling device is in the delay protection state; when $PV(\text{measured temperature}) \leq TS(\text{temperature setting value})$, red led is off and the WORK1 output is off.

4.2 Humidity Control Function (HD, HS, DS)

When HD=H, it is humidification mode, Humidification indicator LED is on . When PV(measured humidity) \leq HS(humidity setting value) – DS(humidification or dehumidification difference setting value),green led is on, WORK2 output works; when PV(measured humidity) \geq HS(humidity setting value),green led is off, and the WORK2 output is off.

When HD=D, it is dehumidification mode, Dehumidification indicator LED is on. When SV(measured humidity) \geq HS(humidity setting value) + DS(humidification or dehumidification difference setting value),green led is on, and the WORK2 output works; green led is blinking , indicating the dehumidification device is in the delay protection state; when SV(measured humidity) \leq HS(humidity setting value), green led is off and the WORK2 output is off.

4.3 Alarm High / Low Temperature Limit Settings(AH, AL)

When measured temperature \geq AH, high temperature limit alarm, PV shows alternate AH with current temperature , buzzer will "bi-bi-Biii" alarm, until the temperature $<$ AH, buzzer off and return to normal display and control. Or press the button to turn the buzzer alarm off only.

When measured temperature \leq AL, low temperature limit alarm, PV shows alternate AL with current temperature, buzzer will "bi-bi-Biii" alarm, until the temperature $>$ AL, buzzer off and return to normal display and control. Or press the button to turn the buzzer alarm off only.

4.4 Alarm High / Low Humidity Limit Settings (AH, AL)

When measured humidity \geq AH, high humidity limit alarm, SV shows alternate AH with current humidity, buzzer will "bi-bi-Biii" alarm, until the humidity $<$ AH, buzzer off and return to normal display and control. Or press the button to turn the buzzer alarm off only.

When measured humidity \leq AL, low humidity limit alarm, PV shows alternate AL with current humidity, buzzer will "bi-bi-Biii" alarm, until the humidity $<$ AL, buzzer off and return to normal display and control. Or press the button to turn the buzzer alarm off only.

4.5 Cooling Dehumidification Delay Protection Time(PT)

In cooling mode, when the power is turned on for the first time, it will not start the cooling immediately when PV(measured temperature value) \geq TS(temperature setting value)+DS(heating or cooling difference value), but waiting for

a delay time(PT).

When two adjacent of cooling starting intervals are greater than the delay time, it will immediately start cooling ; When two adjacent of cooling starting intervals are less than the delay time, it needs to operate the remaining delay time to start the cooling.

Delay time will start counting from the WORK1 output off.

In dehumidification mode , when the power is turned on for the first time, it will not start dehumidification immediately when $SV(\text{measured humidity value}) \geq HS(\text{humidity setting value}) + DS(\text{humidification or dehumidification difference value})$,but waiting for a delay time(PT).

When two adjacent of dehumidification starting intervals are greater than the delay time, it will immediately start dehumidification ; When two adjacent of dehumidification starting intervals are less than the delay time, it needs to operate the remaining delay time to start dehumidification .

Delay time will start counting from the WORK2 output off.

4.6 Temperature and Humidity Calibration (CA)

When the measured temperature or humidity deviates from the standard temperature or humidity, the temperature or humidity calibration function can be used to make the measured the value of the instrument consistent with the standard value.

The calibrated temperature or humidity is equal to the measured temperature or measured humidity value + the calibration value.

4.7 Fahrenheit or Celsius Settings (CF)

The user can set the display unit to Fahrenheit or Celsius according to their habits. P1 temperature mode display unit is Fahrenheit or Celsius, the default is Fahrenheit. If you need to display the unit in Celsius, then set the CF to C. Please note that when the CF changes state, all setting values are restored to the default setting and the buzzer gives a short beeping prompt.



CONFORMS TO UL
Std.1363
CERTIFIED TO CSA
STD.C22.2#308



CANOPIA[®]
by PALRAM

www.canopia.com



A member of Palram Industries Ltd.