



Farm fresh food at home

4ft x 3ft Rectangle Raised Garden Bed



Ten year warranty

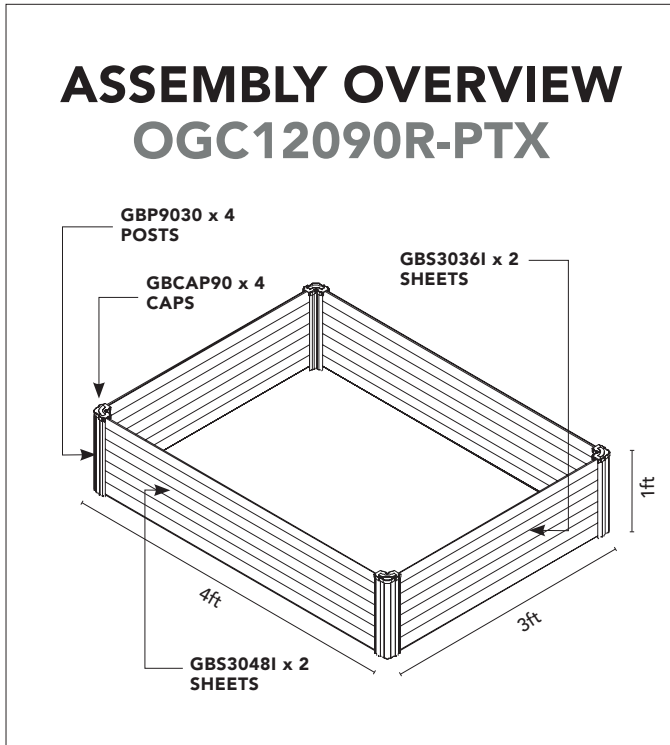

PACKING LIST:

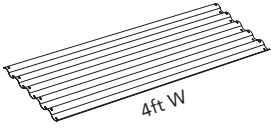
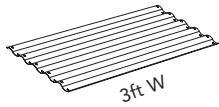
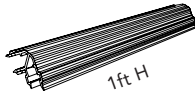
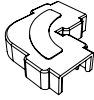
SHEETING			
PART NUMBER		QTY	CHECK
 4ft W	GBS30481	2	
 3ft W	GBS30361	2	
POSTS & CAPS			
 1ft H	GBP9030	4	
	GBCAP90	4	

! FIRST STEPS

Using safety gloves, unpack your carton. Check off the parts using the packing list. When assembling, most parts should slide together with minimal effort. Use a rubber mallet to gently tap components into position. Any questions? Call us on 0866 788 3046.

IMPORTANT

It is advised that you install your garden bed on a flat/even surface to avoid leakages and maintain an even weight distribution.

Incorrect installation will void the warranty.

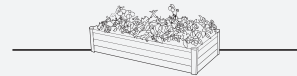

1 SLIDE POSTS ONTO SHEETS

Organic Garden Co garden beds use the SNAPTITE Assembly System. Ensure that the lugs in the steel sheet click into the posts correctly, see below diagram.

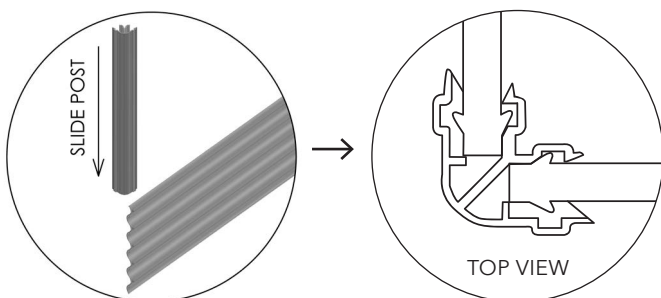

2 SAFETY CAPS

Clip on the safety caps to each post. Use a mallet to tap into place if necessary.

