



# ASSEMBLY INSTRUCTIONS

## CRANK ADJUST® BASKETBALL SYSTEM

**MODEL 90568**

### BEFORE ASSEMBLY:

- Requires at least 1040 lb (472 kg) of concrete mix to fill a volume of 7.78 ft<sup>3</sup> (0.22 m<sup>3</sup>)
- Requires at least 3 days (72 hours) for concrete to cure, plus 3–4 hours to complete assembly steps
- At least 3 people recommended for setup



**WATCH  
3D ANIMATION  
OF THE FULL ASSEMBLY**











**BILT.®**

Download on the **App Store**

GET IT ON **Google Play**

SCAN THE CODE  OR SEARCH 1189604

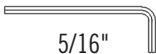
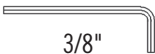
### TOOLS REQUIRED

 Carpenter's Level	 Shovel	 Tape Measure	 Concrete Mix (80 lb bag x 13)
 1/2" (x2)	 3/4" (x2)	 9/16" (x2)	 Electric Drill
 5/16" (x1, included)	 3/8" (x1, included)	 Rubber Mallet	

### TABLE OF CONTENTS

Icon Legend.....	2
Warnings & Notices.....	3
Initial Setup.....	4
Pole Assembly.....	7
Extension Arm Assembly.....	10
Handle Assembly.....	14
Backboard-to-Rim Assembly.....	17
Parts Identifier.....	i-iv
Backboard-to-Pole Assembly.....	24
Final Assembly.....	27
Maintenance Instructions.....	32
Registration.....	33
Warning Sticker.....	34
Warranty.....	35

### QUESTIONS?

### CONTACT LIFETIME CUSTOMER SERVICE:

Dial **1-800-225-3865**  
7:00 am–5:00 pm (M–F) MST  
and 9:00 am–1:00 pm (Sat) MST

Live Chat:  
[www.lifetime.com/customerservice](http://www.lifetime.com/customerservice)  
(Click on the "LIVE CHAT" tab)

For Customer Service in Mainland  
Europe and the United Kingdom,  
E-mail: [cs@lifetimeproducts.eu](mailto:cs@lifetimeproducts.eu)

Model Number: **90568**  
Product ID:



## ICON LEGEND



- Indicates special heed should be taken when reading.



- Indicates the parts to be used for a section.



- Indicates no parts required for a specific section.



- Indicates the hardware to be used for a section.



- Indicates no hardware required for a specific page.



- Indicates the tools to be used for a section.



- Indicates to use/not to use an electric drill for a specific step.

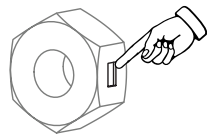

- Indicates the use of a centerlock nut. A nut with this marking will require some effort to tighten. This hardware was designed with this feature in order to prevent loosening later.



## WARNINGS & NOTICES



### SAFETY INSTRUCTIONS



**FAILURE TO FOLLOW THESE WARNINGS MAY RESULT IN SERIOUS INJURY OR PROPERTY DAMAGE AND WILL VOID WARRANTY.**

*Owner must ensure that all players know and follow these rules for safe operation of the system.*

To ensure safety, do not attempt to assemble this product without following the instructions carefully. Check entire box and inside all packing material for parts and/or additional instruction material. Before beginning assembly, read the instructions and identify parts using the hardware identifier and parts list in this document. Proper and complete assembly, use and supervision are essential for proper operation and to reduce the risk of accident or injury. A high probability of serious injury exists if this product is not installed, maintained, and operated properly.

- If using a ladder during assembly, use extreme caution.
- Three capable adults are recommended for this operation.
- Assemble the pole sections properly. Failure to do so could cause the pole sections to separate during play or transport.
- Before digging, contact utility company to locate underground power cables, gas, and water lines. Ensure that there are no overhead power lines within 20' (7 m) radius of pole locations.
- Minimum operational height is 6'-6" (1.98 m) to the bottom of the backboard.

***Most injuries are caused by misuse and/or not following instructions. Use caution when using this product.***



### SAFE HANDLING OF THE GLASS BACKBOARD



#### BEFORE & DURING ASSEMBLY

1. Thoroughly inspect the backboard before beginning assembly. Do not use the backboard if there are any chips, cracks, or other defects in the board. Call our customer service department if any problems are found.
2. Use extreme caution when handling or working around the backboard.
3. Keep tools, hardware, and other sharp and heavy objects away from the backboard.
4. Never rest the backboard directly on a hard surface, such as concrete or pavement. Always place cardboard or other cushioning material between the backboard and the ground or other hard surfaces.
5. Always lay the backboard flat. Never place it in a position where it might tip over and break.
6. Glass is very heavy. Always use at least two adults when picking up or moving the backboard.

#### General Handling & Care

1. Inspect the backboard before each use. Do not use the backboard if there are any chips, cracks, or other defects in the board. If any signs of damage are found, follow the instructions for "handling broken glass" below.
2. Use extreme caution when handling or working around the backboard.
3. The backboard was designed for use with a basketball. Do not use other types of balls or other objects with the system. Do not use this system for any purpose other than its designed purpose.

#### Handling Broken Glass

##### **At the first sign of breakage:**

1. Keep everyone, especially children, away from the immediate area of the backboard.
2. Put on eye protection, and wear thick utility gloves and long sleeves. Small pieces of tempered glass may pop out of the backboard.
3. Lower the backboard to its lowest height, and completely cover the backboard with a tarp.
4. Do not remove the backboard from the system without first lowering the system to its lowest setting. Carefully read and follow the "removing backboard from system" instructions below.

#### Removing Backboard from System

1. With the backboard at its lowest height, have at least two capable adults support the system while one adult removes the hardware securing the pole to the playing surface.
2. Have at least three capable adults carefully lay the system down. Make sure to rest the rim on a sheet of cardboard or other non-abrasive surface.
3. Loosen and remove the hardware from the steps performed in the *backboard to pole assembly section* of this manual in reverse order. Keep the hardware.
4. Loosen and remove the hardware from the steps performed in the *backboard to rim assembly section* to safely remove the rim. Keep all parts and hardware from this section for reassembly.

# 1

## INITIAL SETUP



### HARDWARE REQUIRED

Hardware Blister Pack

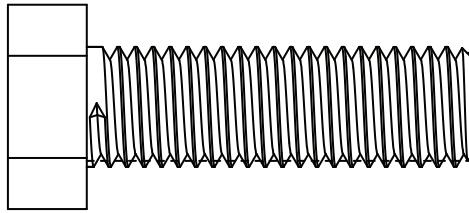

AE0 (x1)

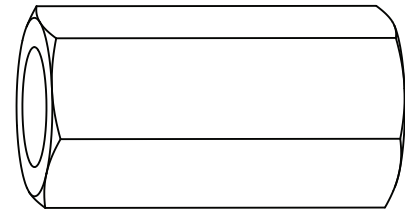

CYV (x1)

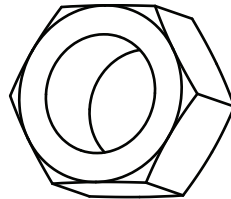

AOE (x8)



### PARTS REQUIRED

Metal Parts

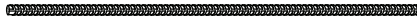

AEZ (x4)



AEI (x4)

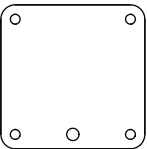

AKT (x1)



### TOOLS REQUIRED



3/4"  
(x2)

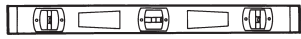

Carpenter's Level



Shovel



Tape Measure



Concrete Mix  
(80 lb bag x 13)

## SECTION 1 (CONTINUED)

### TOOLS AND HARDWARE REQUIRED

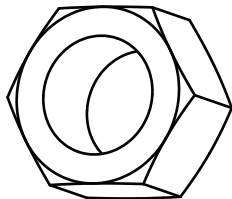
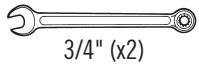

AOE (x8)

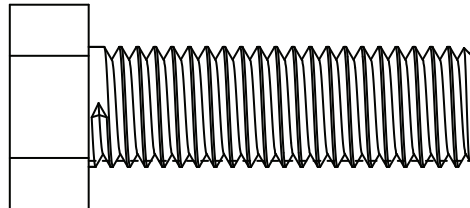

AEI (x1)



CYV (x1)

## 1.1

- Dig a hole 30" (76.2 cm) deep and 21" (53 cm) square. The edge of the hole should be flush with the edge of the playing court. If you live in an area where frost heaves may pose a problem, consult your local building inspector to determine the appropriate hole depth. Bell out the bottom of the hole as illustrated. We recommend building a form to keep the top of the concrete level and square. Place the form so it is level with the playing surface.

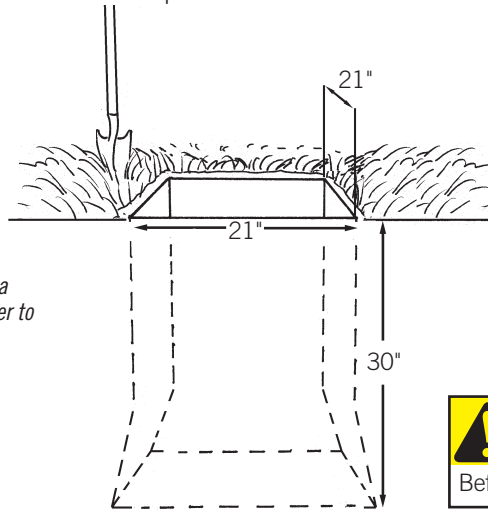

- There must be a 3' (92 cm) area behind the pole to allow the user to adjust the Rim height.



## CAUTION

Before digging, call to locate any buried utility lines.

## 1.2

- Thread a **nut (AOE)** all the way onto each **J-bolt (AEI)**. Slide the threaded ends of the J-bolts through the corner holes in the **template (AKT)**, and secure them completely with **nuts (AOE)**. Insert the **bolt (AEI)** through the center hole in the template and tighten the **nut coupler (CYV)** onto the bolt as far as it will go.

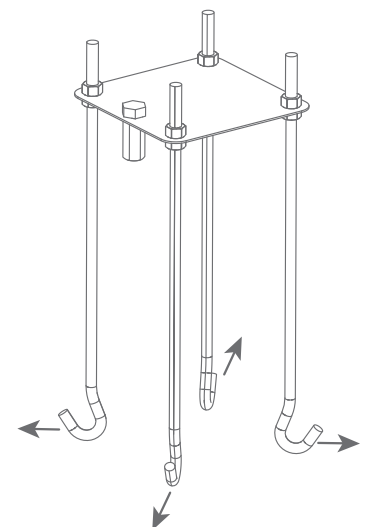
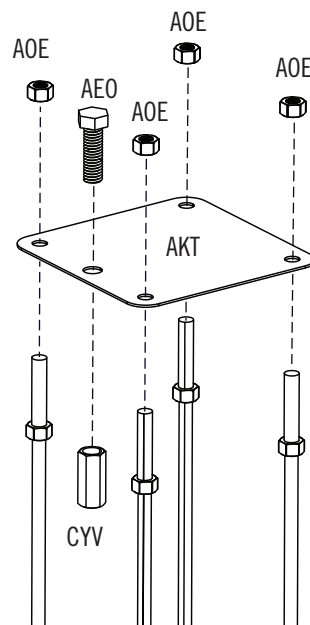
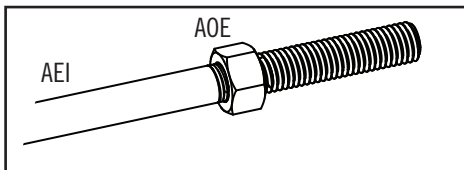

- Ensure the curved ends of the J-bolts point outward away from the corners as shown.

## ► SECTION 1 (CONTINUED)

### TOOLS AND HARDWARE REQUIRED



80 lb (x13)



# 1.3

- If you are using concrete mix, mix the concrete according to the instructions on the bags. **Please note that a thicker mix of concrete will dry stronger.** Pour the concrete into the hole, stopping about 18" (46 cm) from the top of the hole. Push the four pieces of **24" rebar (AEZ)** firmly to the bottom of the hole. The rebar should be arranged in a square about 8" (20 cm) wide in the center of the hole so each piece will be next to a J-bolt when it is placed in the concrete mix. Finish filling the hole to the top with concrete. The top of the concrete should extend about 1/2" (13 mm) above the playing surface and slope downward toward the playing surface to allow water runoff.

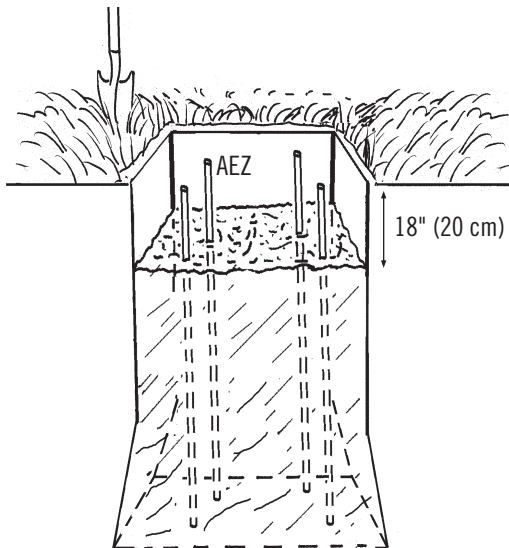

# 1.4

- Center the **template (AKT)** over the hole. Insert the **J-bolts (AEI)** into the concrete and agitate the Template assembly to eliminate any air bubbles. Push the J-bolts into the concrete mix until the Template is resting flat against the concrete. Form the concrete into a downward slope toward the playing surface to allow water runoff. **The lower four nuts (AOE) will be in the concrete permanently.** Clean off any concrete on the template or the exposed portion of the J-bolts. Using a carpenter's level, **ensure the Template is square to the playing surface.** Plate should be level and about 1/2" above the playing surface for water to drain off of the steel.

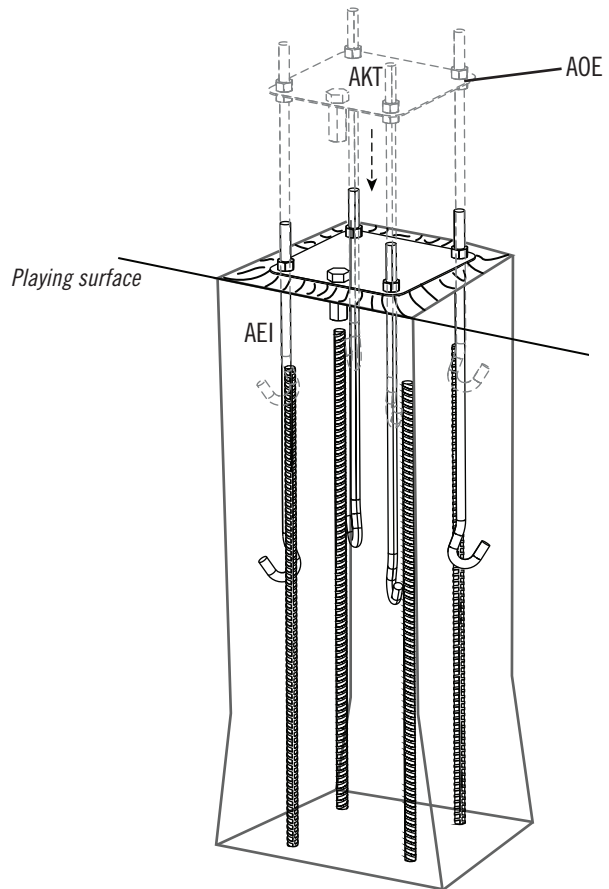

- You are now finished with the initial assembly steps. **DO NOT PROCEED WITH THE ASSEMBLY** until the concrete has fully cured. Curing will take a minimum of 72 hours (3 days). In humid climates or wet weather, allow additional time for the concrete to cure. Never use the system without first following the initial setup instructions.

# 2

## POLE ASSEMBLY



### HARDWARE REQUIRED

Hardware Blister Pack



CMV (x1)

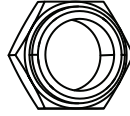

CUB (x2)

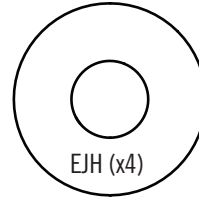

EJH (x4)

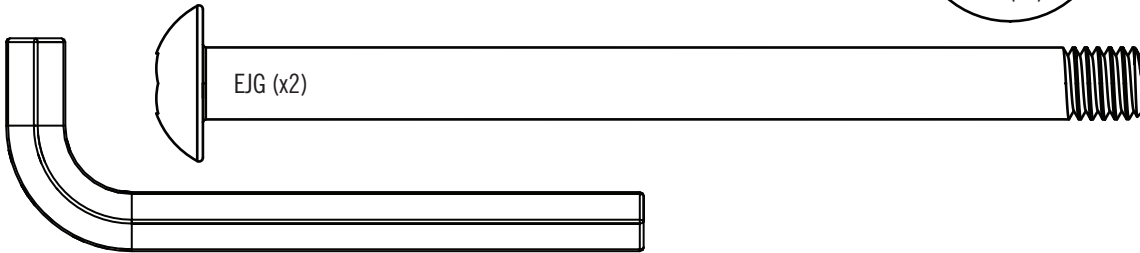

EJG (x2)

ELW (x1)



### PARTS REQUIRED

Large Parts



ALH (x1)

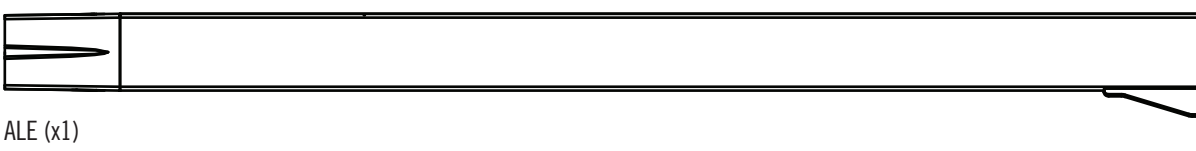

ALE (x1)

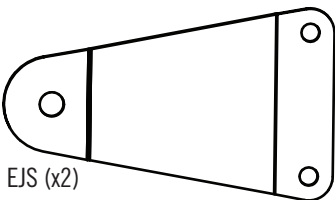

EJS (x2)



### TOOLS REQUIRED



5/16"  
(x1, included)



9/16" (x1)



Electric Drill

## ► SECTION 2 (CONTINUED)

TOOLS AND HARDWARE REQUIRED



### 2.1

- Slide the flared end of the **top pole (ALH)** onto the swaged end of the **bottom pole (ALE)**. The small hole in the bottom of the top pole should face away from the playing surface.

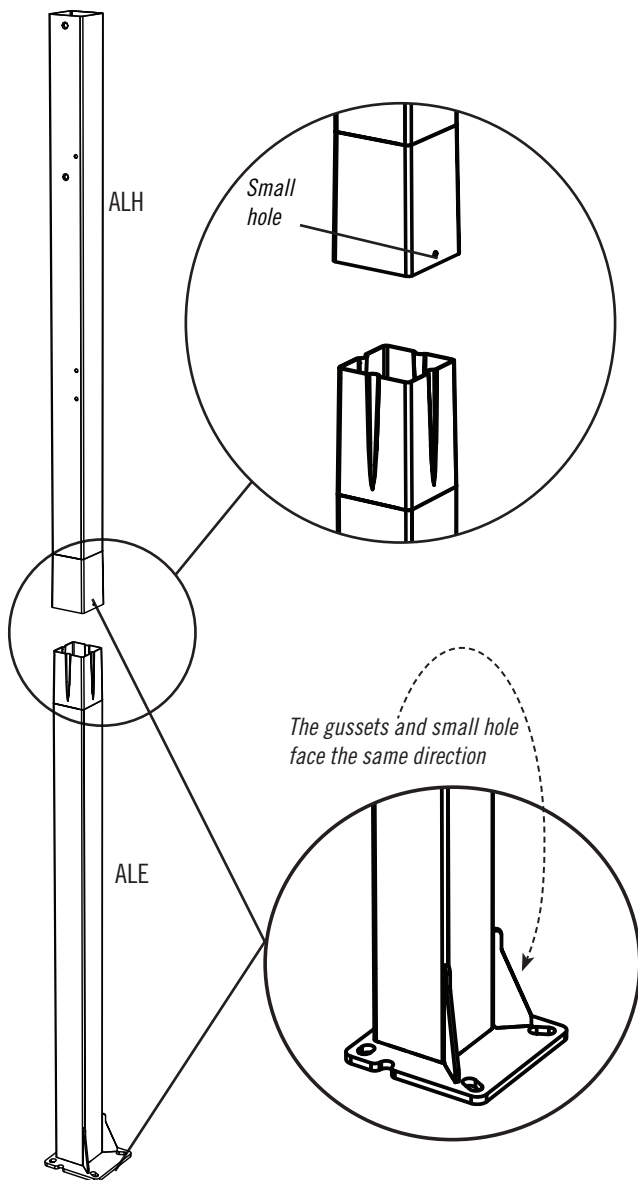

### 2.2

- Raise the pole assembly about 12 inches off the ground. Strike the end of the poles against a piece of scrap wood or thick cardboard three times to ensure the poles are seated properly.



#### WARNING

Do not hit your feet with the Pole Sections, as serious injury could occur.



#### WARNING

The Poles must be seated together! Even if the Poles cover the slots before seating, they must be struck on a hard surface three times! Failure to seat the Poles correctly could allow the Poles to separate during use, which could lead to serious personal injuries or property damage.





## SECTION 2 (CONTINUED)

TOOLS AND HARDWARE REQUIRED

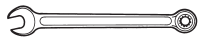

9/16"



5/16"

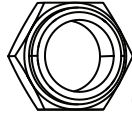
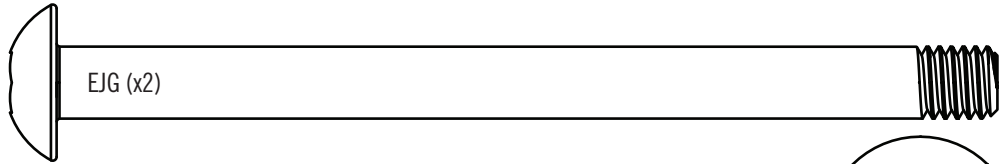

CUB (x2)



CMV (x1)

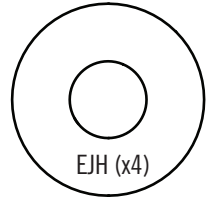

EJH (x4)

### 2.3

- Use the **screw (CMV)** provided to secure the top pole to the bottom pole. You may need to use a hex driver or chuck the screw directly into an electric drill.

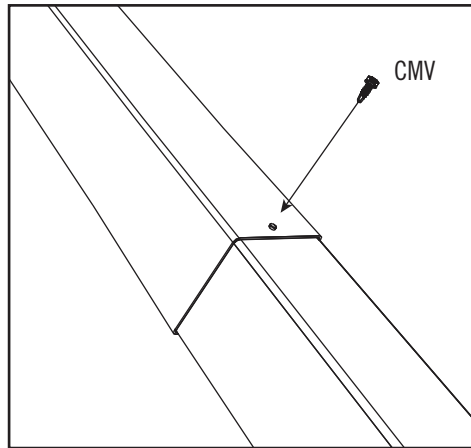

### 2.4

- Attach the **pole brackets (EJS)** to the **top pole (ALH)** with the hardware shown.

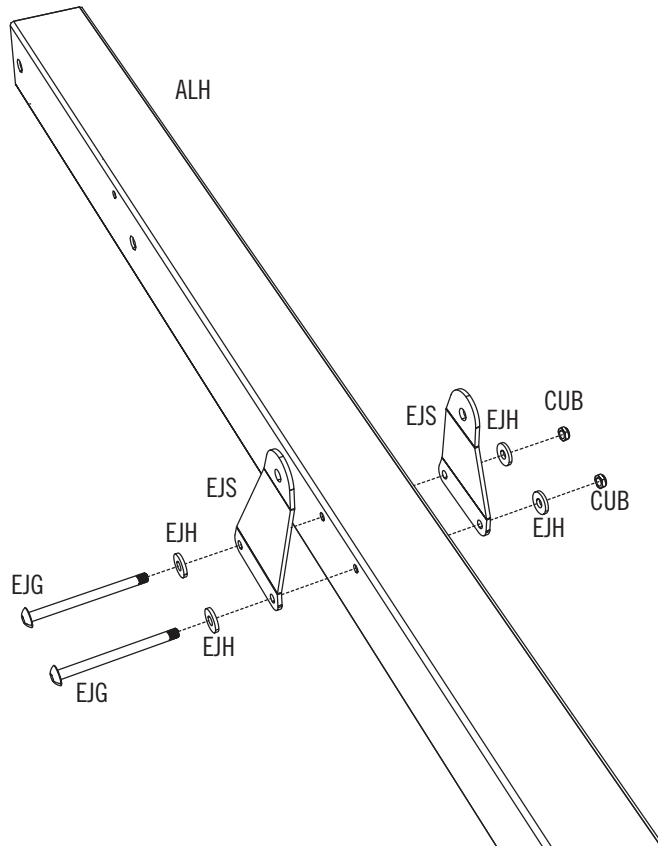

# 3

## EXTENSION ARM ASSEMBLY



### HARDWARE REQUIRED

Hardware Blister Pack

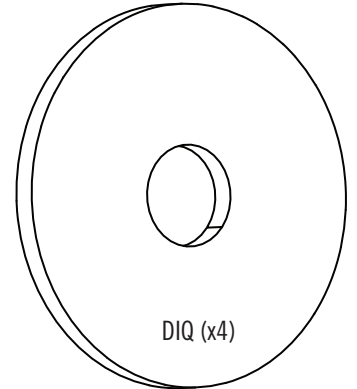
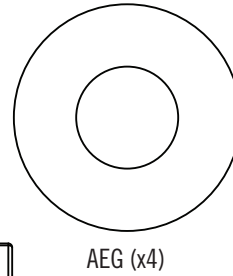
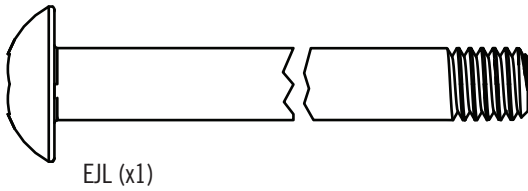
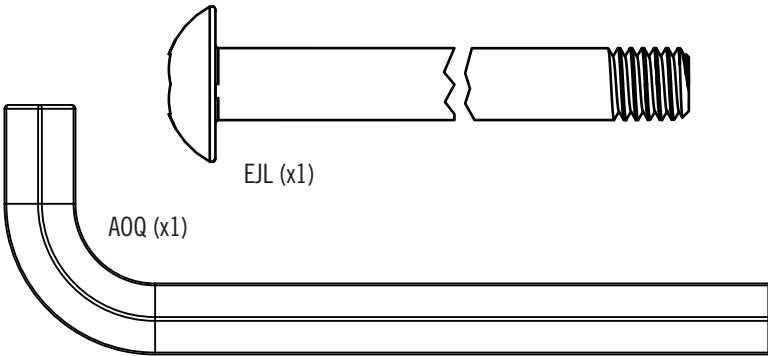
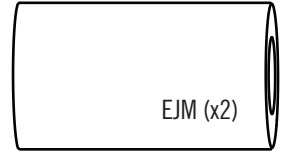
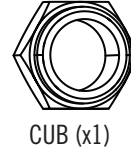
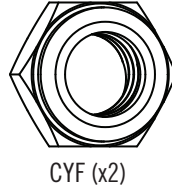
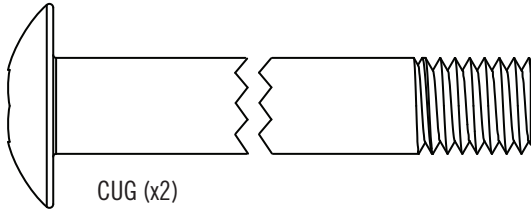

### PARTS REQUIRED

Metal Parts

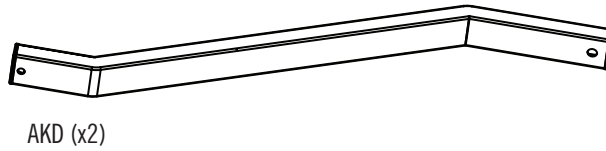
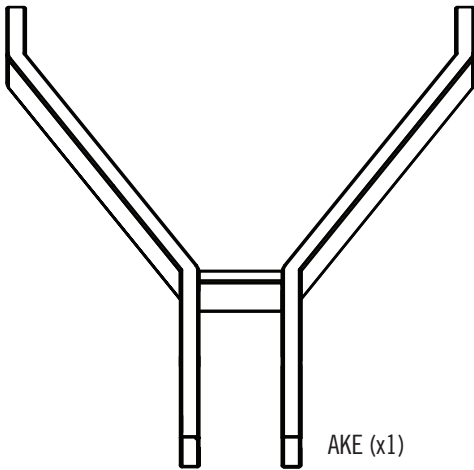

### TOOLS REQUIRED

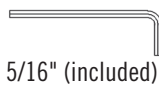
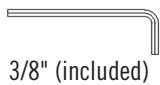
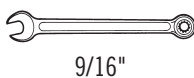
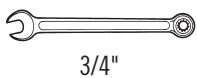

## ► SECTION 3 (CONTINUED)

### TOOLS AND HARDWARE REQUIRED



3/4"

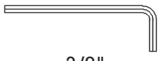

3/8"

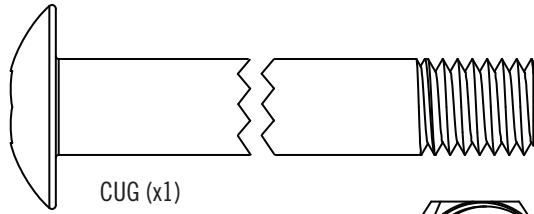

CUG (x1)

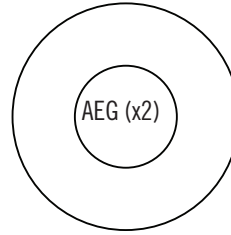

AEG (x2)

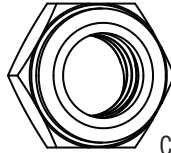

CYF (x1)

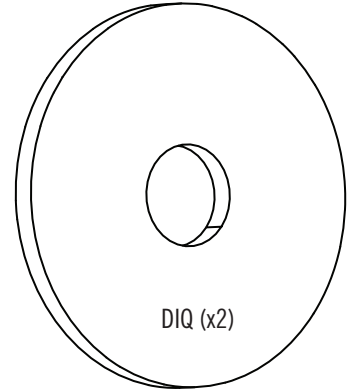

DIQ (x2)

# 3.1

- Secure the **lower extension arm assembly (AKE)** through the first set of holes on the pole above the handle brackets. Ensure the **large plastic washers (DIQ)** are placed between the extension arms and the pole on each side.

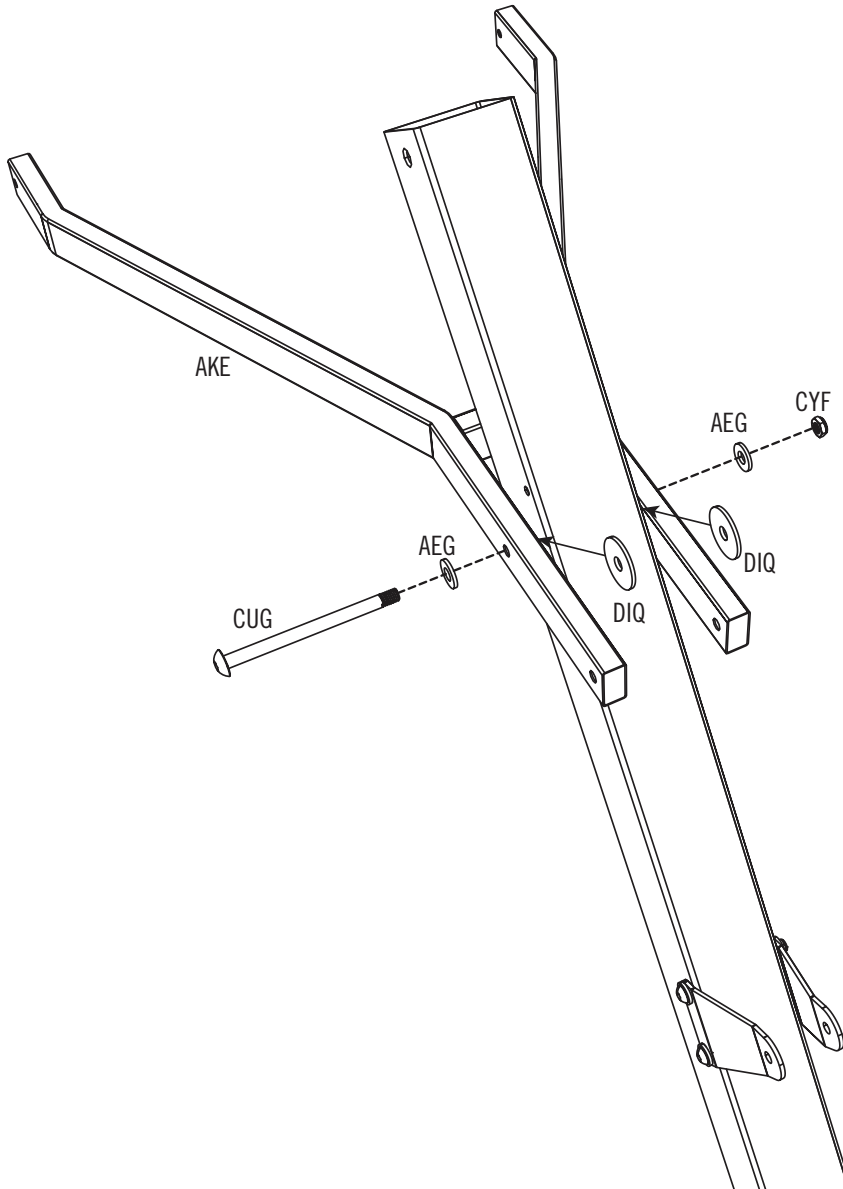

## ► SECTION 3 (CONTINUED)

TOOLS AND HARDWARE REQUIRED



9/16"

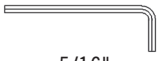

5/16"

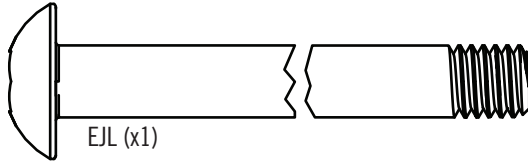

EJL (x1)

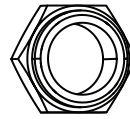

CUB (x1)

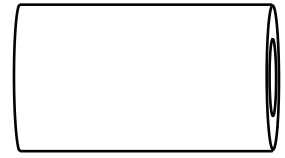

EJM (x2)

## 3.2

- Install the hardware indicated in the location shown.

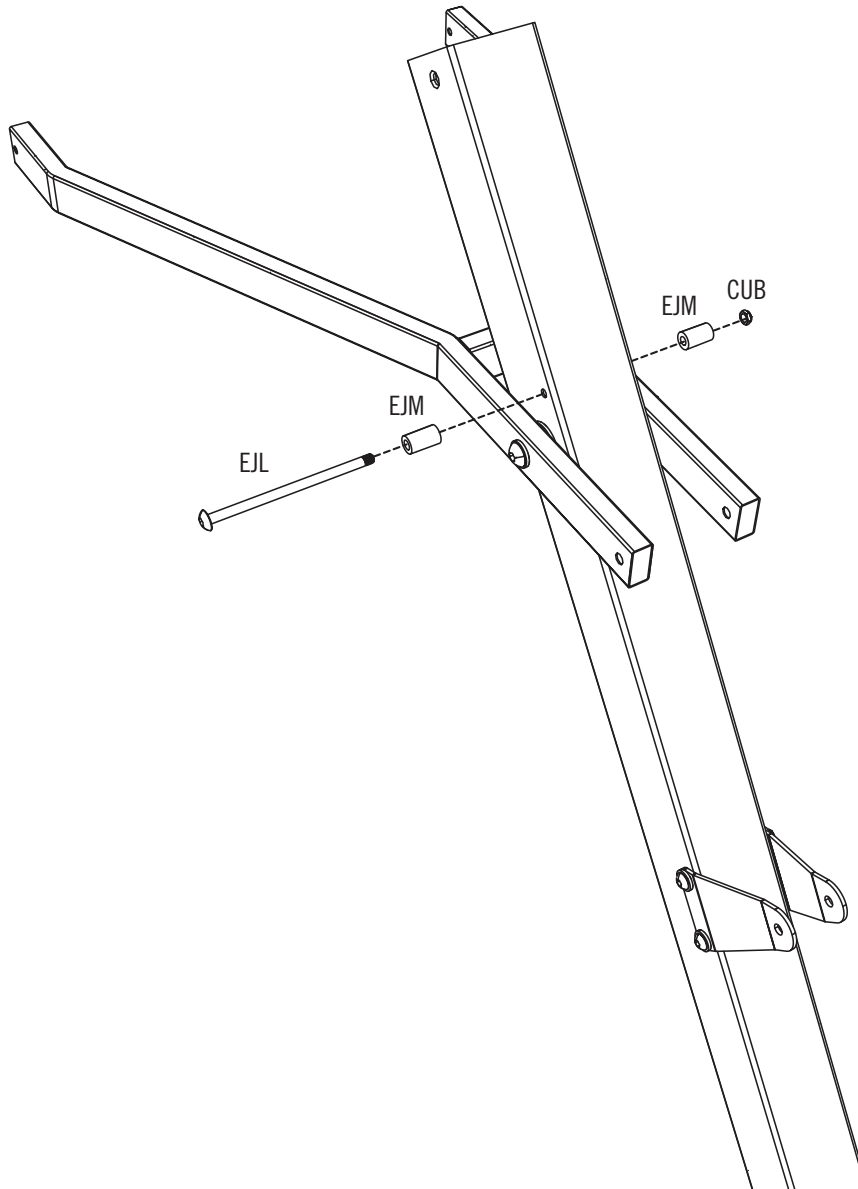

## SECTION 3 (CONTINUED)

TOOLS AND HARDWARE REQUIRED



3/4"

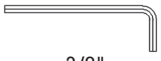

3/8"

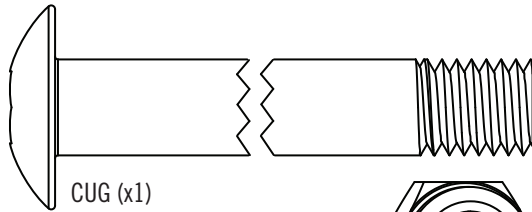

CUG (x1)

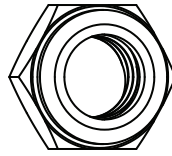

CYF (x1)

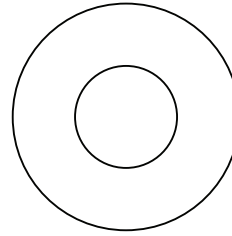

AEG (x2)

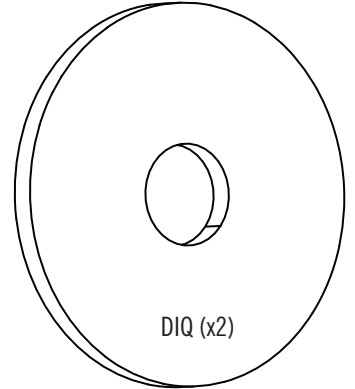

DIQ (x2)

# 3.3

- Attach the **upper extension arms (AKD)** to the pole as shown.

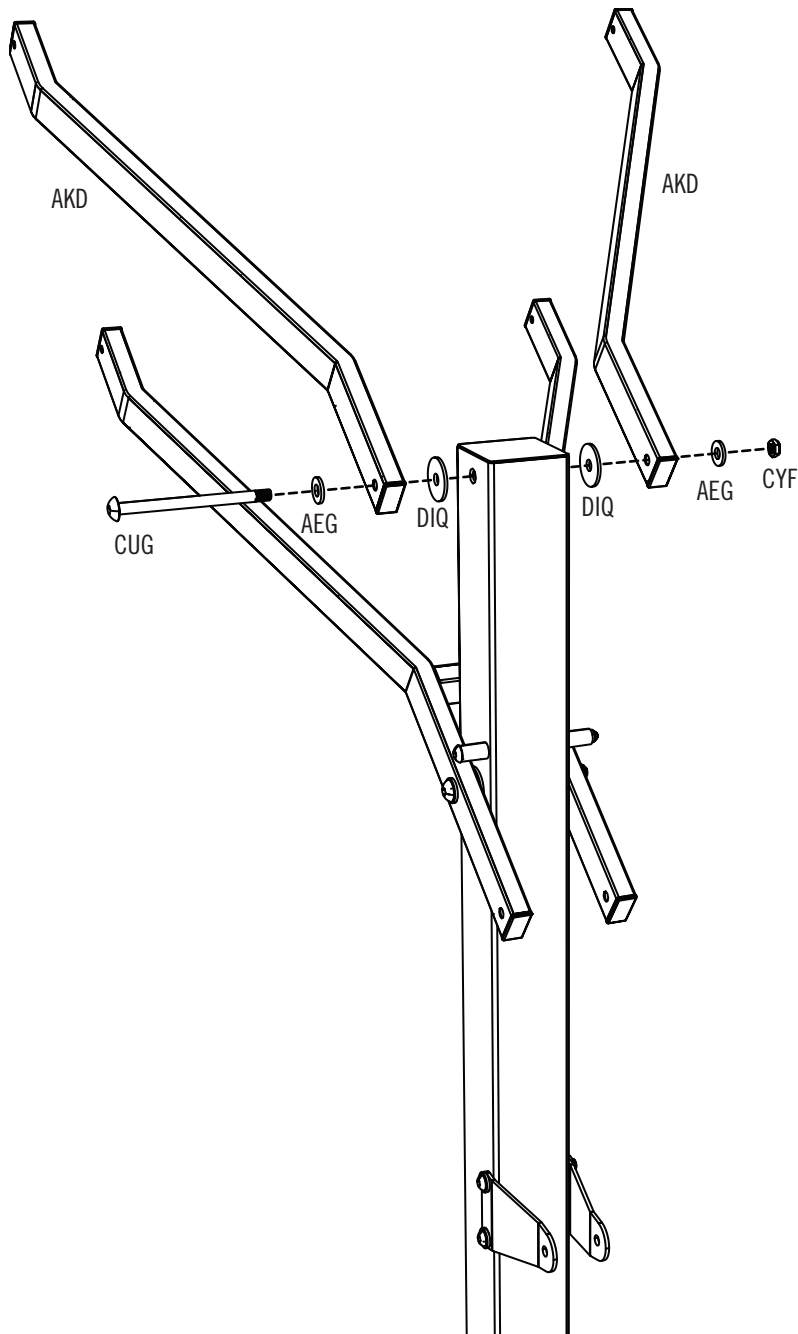

# 4

## HANDLE ASSEMBLY



### HARDWARE REQUIRED

Hardware Blister Pack

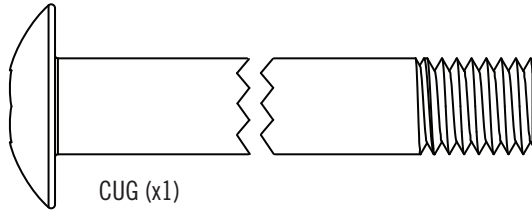
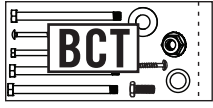

CUG (x1)

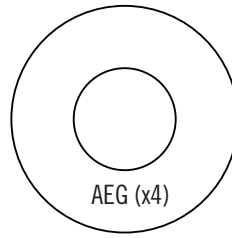

AEG (x4)

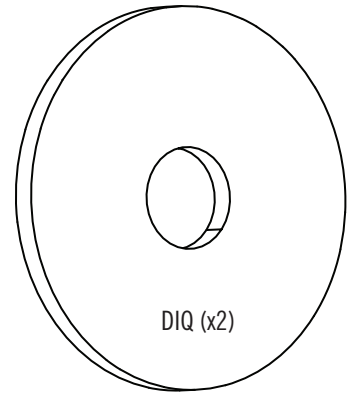

DIQ (x2)

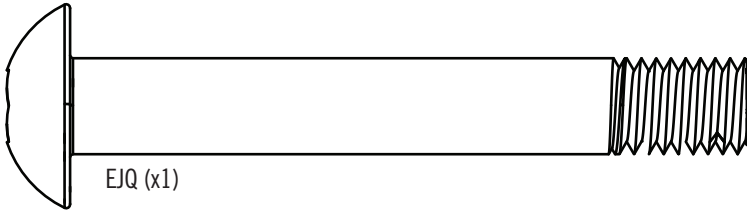

EJQ (x1)

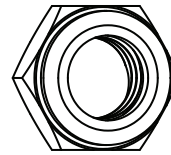

CYF (x2)



### PARTS REQUIRED

Large Parts

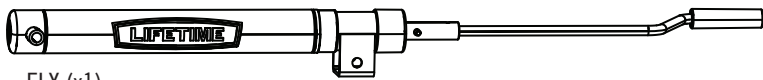

ELX (x1)



### TOOLS REQUIRED



3/4"



3/8"

## ► SECTION 4 (CONTINUED)

TOOLS AND HARDWARE REQUIRED



3/4"



3/8"

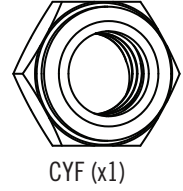
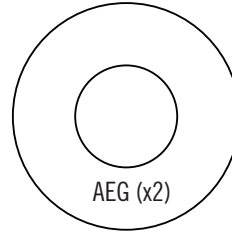
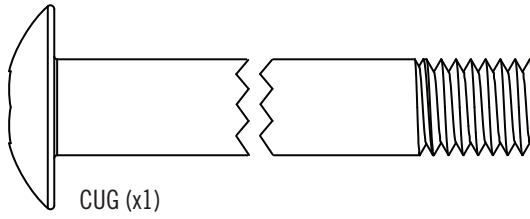

### 4.1

- Align the spacer at the top of the **crank adjust assembly (ELX)** with the holes in the lower extension arms. Secure using the hardware shown, but do not overtighten this hardware.

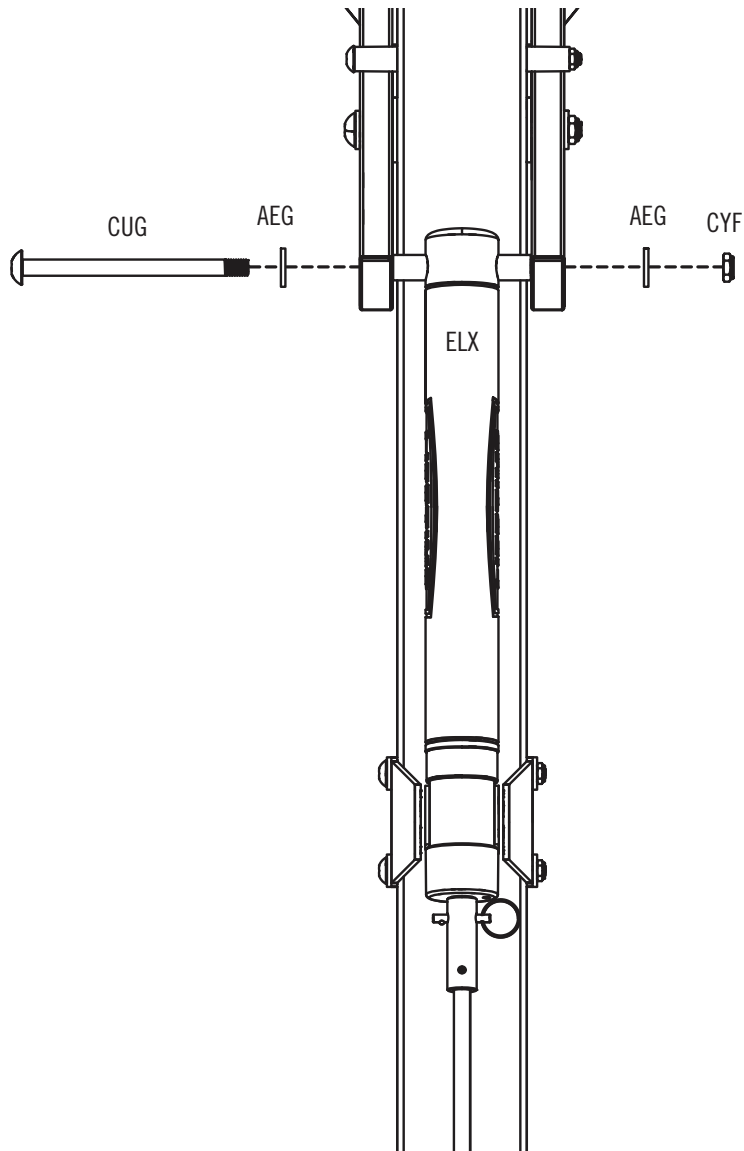

## ► SECTION 4 (CONTINUED)

TOOLS AND HARDWARE REQUIRED

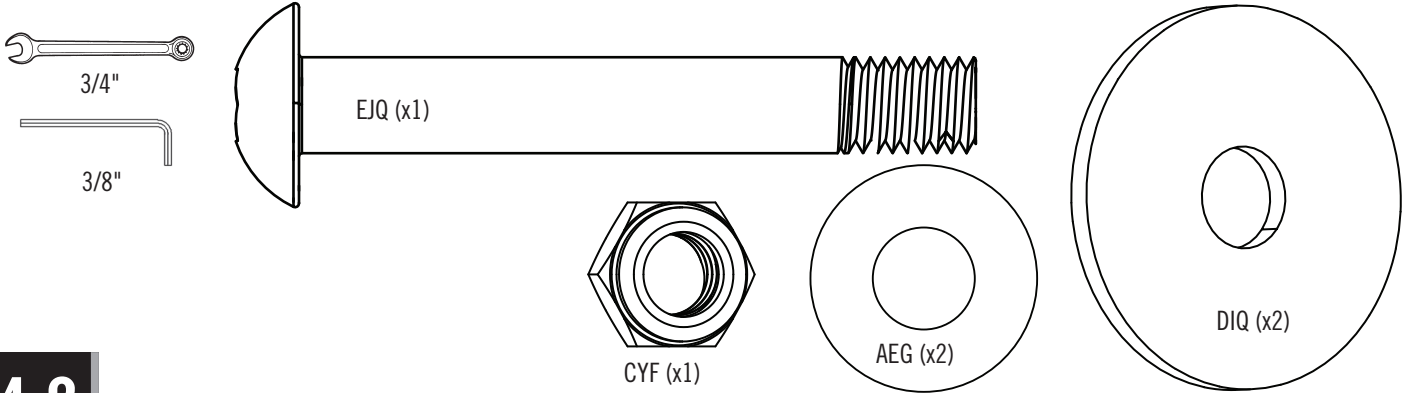

# 4.2

- Install the hardware indicated in the location shown. Make sure the **large plastic spacers (DIQ)** are placed between the crank adjust assembly and the handle brackets.

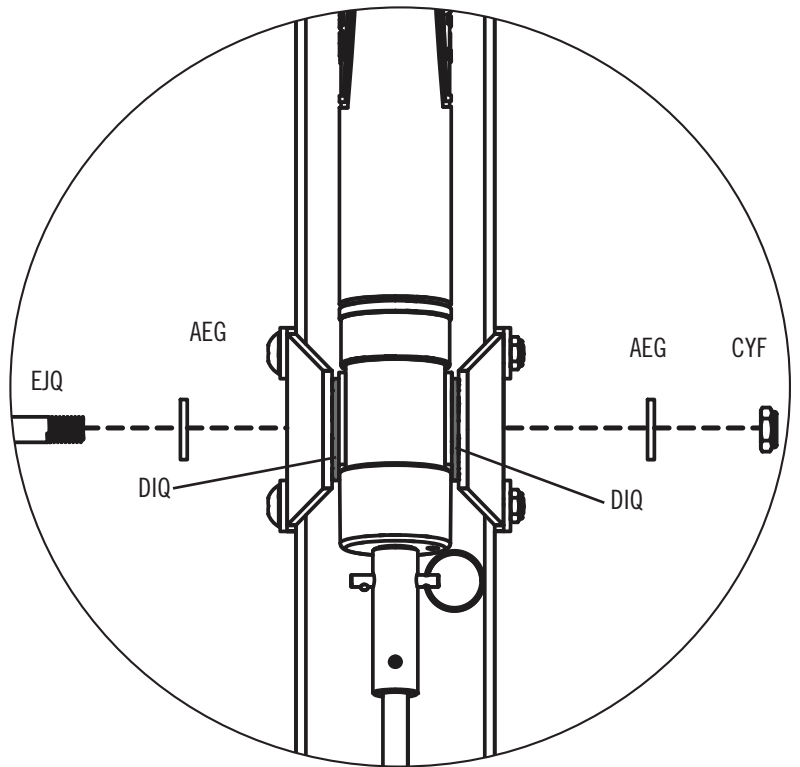
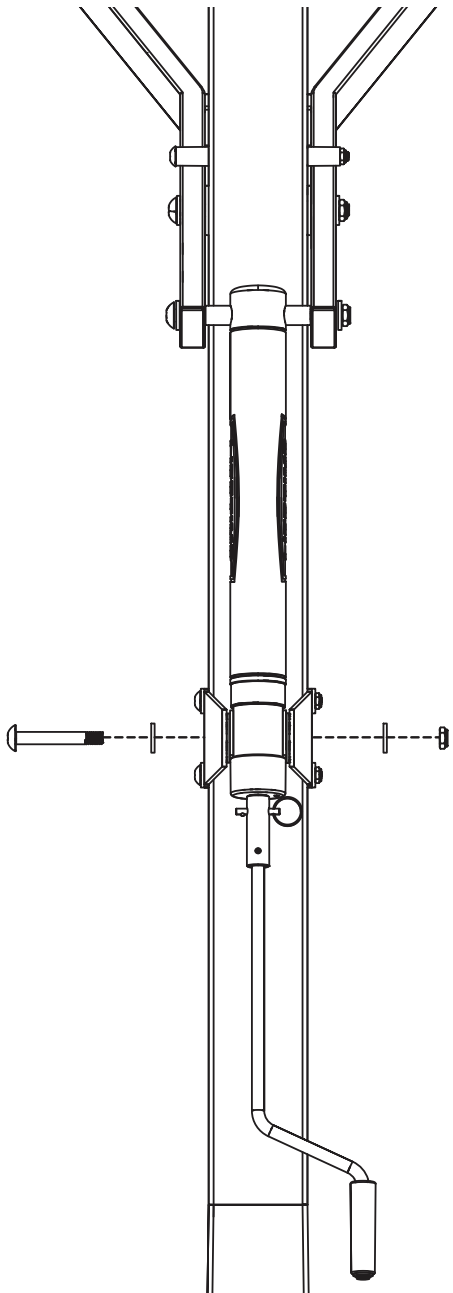



# 5

## BACKBOARD-TO-RIM ASSEMBLY



### HARDWARE REQUIRED

Hardware Blister Pack

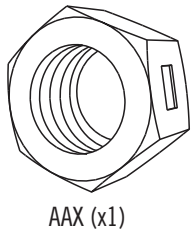
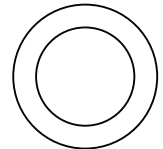
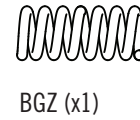
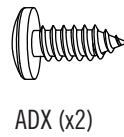
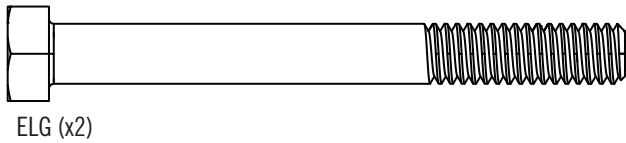
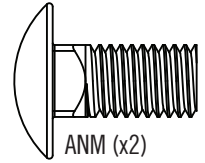
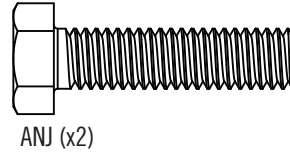
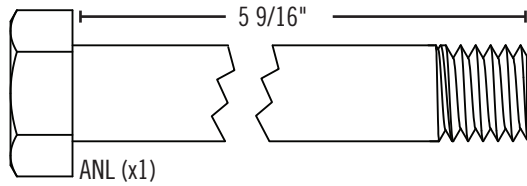
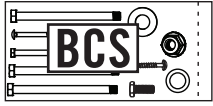

### PARTS REQUIRED

Glass and Metal Parts

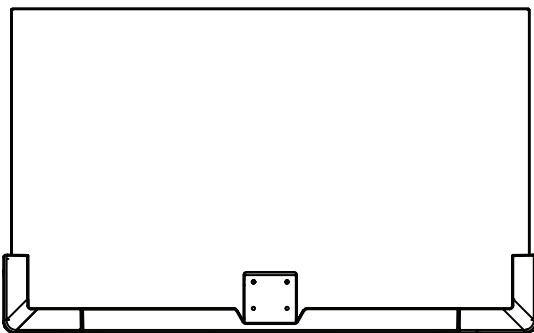

AJI (x1)

# 5

## BACKBOARD-TO-RIM ASSEMBLY



### PARTS REQUIRED

Metal Parts

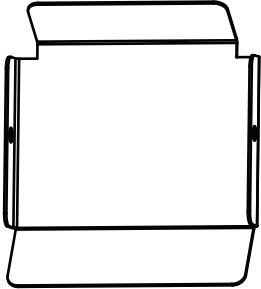

AMA (x1)

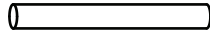

BPZ (x1)

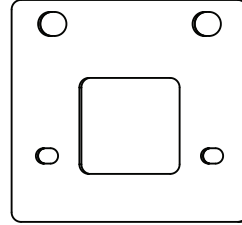

BGY (x1)

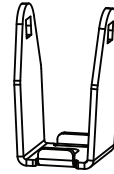

AMK (x1)

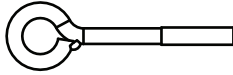

BQA (x1)

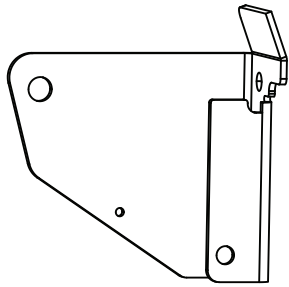

AMC (x1)

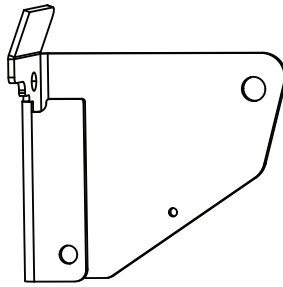

AMB (x1)

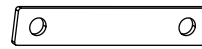

ALY (x1)

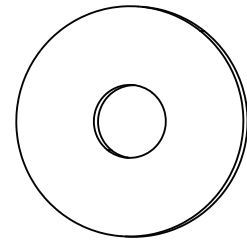

ANO (x1)

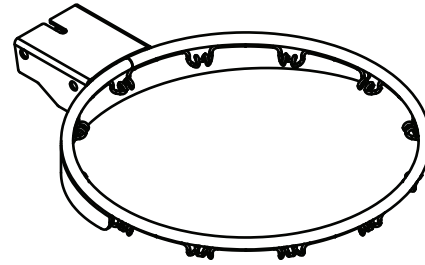

ALX (x1)



### TOOLS REQUIRED



(1)



1/2"

(2)



9/16"

(2)



3/4"

(2)



*This page intentionally left blank*

*Lift out this section for use as a quick reference*



# PARTS IDENTIFIER

## Metal Parts

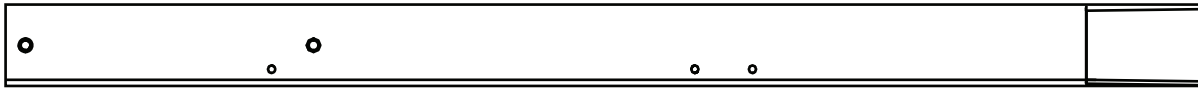

ALH (x1)



ALE (x1)

*Lift out this section for use as a quick reference*

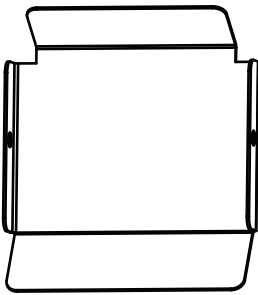

AMA (x1)

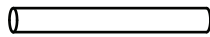

BPZ (x1)

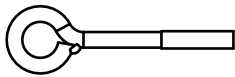

BQA (x1)

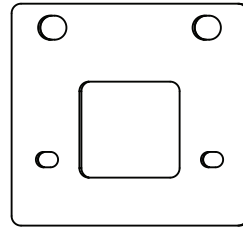

BGY (x1)

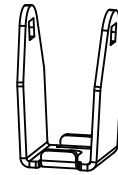

AMK (x1)

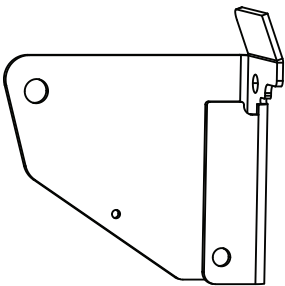

AMC (x1)

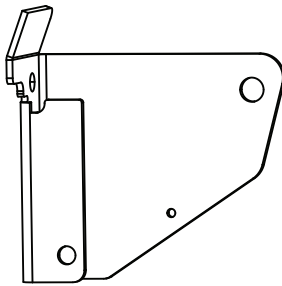

AMB (x1)



ALY (x1)

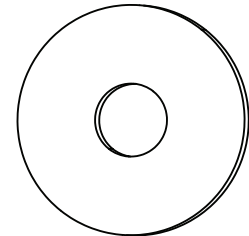

ANO (x1)

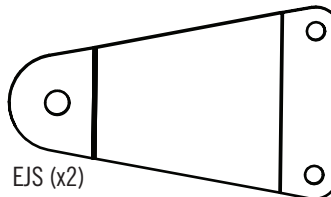

EJS (x2)



# PARTS IDENTIFIER

## Metal Parts

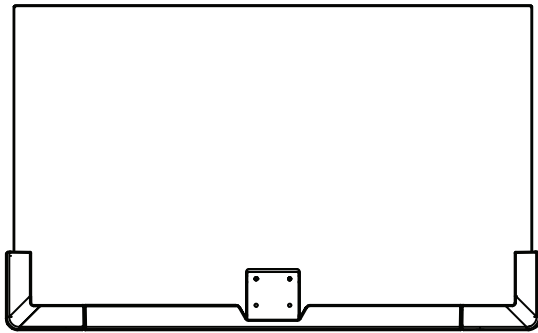

AJI (x1)

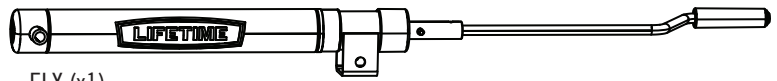

ELX (x1)



AKD (x2)



AEZ (x4)

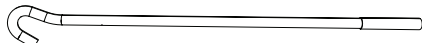

AEI (x4)

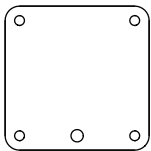

AKT (x1)

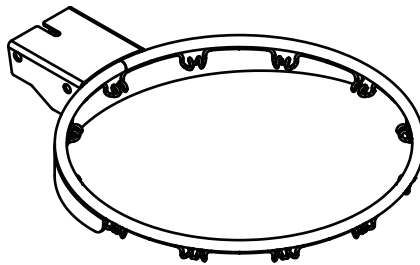

ALX (x1)

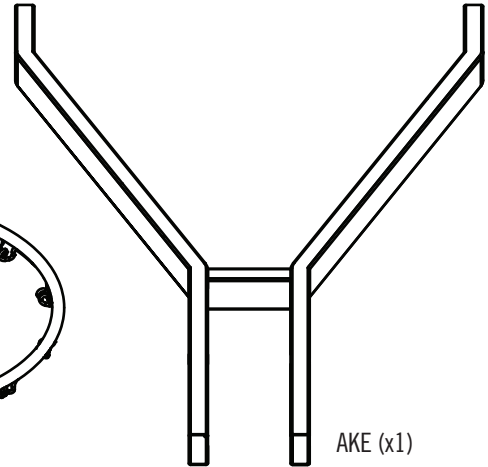

AKE (x1)

Lift out this section for use as a quick reference

## Plastic Parts

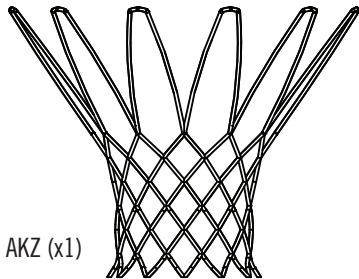

AKZ (x1)



AKP (x1)



# HARDWARE PACK S

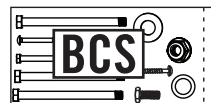
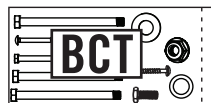



*Lift out this section for use as a quick reference*

*This page intentionally left blank*

## SECTION 5 (CONTINUED)

TOOLS AND HARDWARE REQUIRED

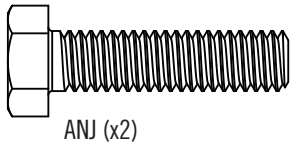

ANJ (x2)

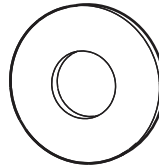

ABD (x4)

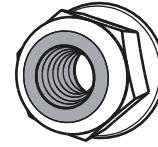

ABK (x2)



- In case of any trouble with this section, scan the code below to view a video on its assembly.

YouTube

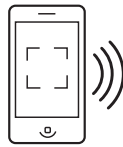

- <http://go.lifetime.com/crankadjustbackboardtorim>

### 5.1

- Lay the **backboard (AJI)** face up with the rim holes exposed over the edge of a table. Place the **rim impact spacer (BGY)** in the backboard. Add the **left and right rim housings (AMC and AMB)** on top of the rim impact spacer and slide the hardware shown into place.

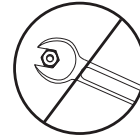
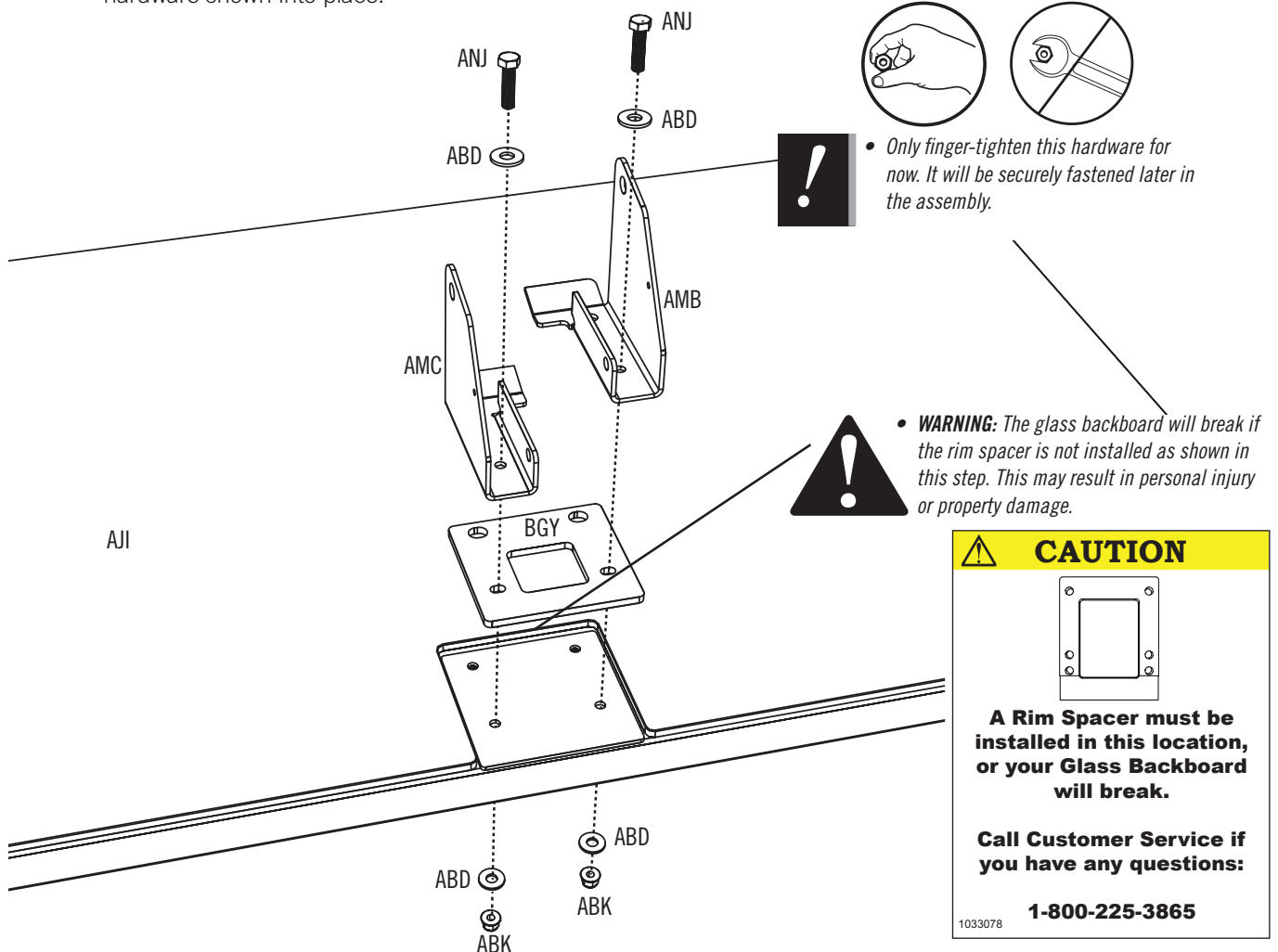

- Only finger-tighten this hardware for now. It will be securely fastened later in the assembly.

#### CAUTION

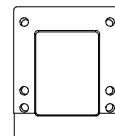

**A Rim Spacer must be installed in this location, or your Glass Backboard will break.**

**Call Customer Service if you have any questions:**

**1-800-225-3865**

1033078

## SECTION 5 (CONTINUED)

TOOLS AND HARDWARE REQUIRED

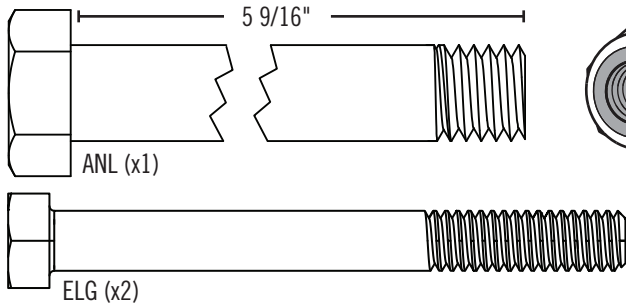

### 5.2

- Secure the **rim adapter plate (ALY)** to the **backboard (AJI)** by using the hardware as shown.

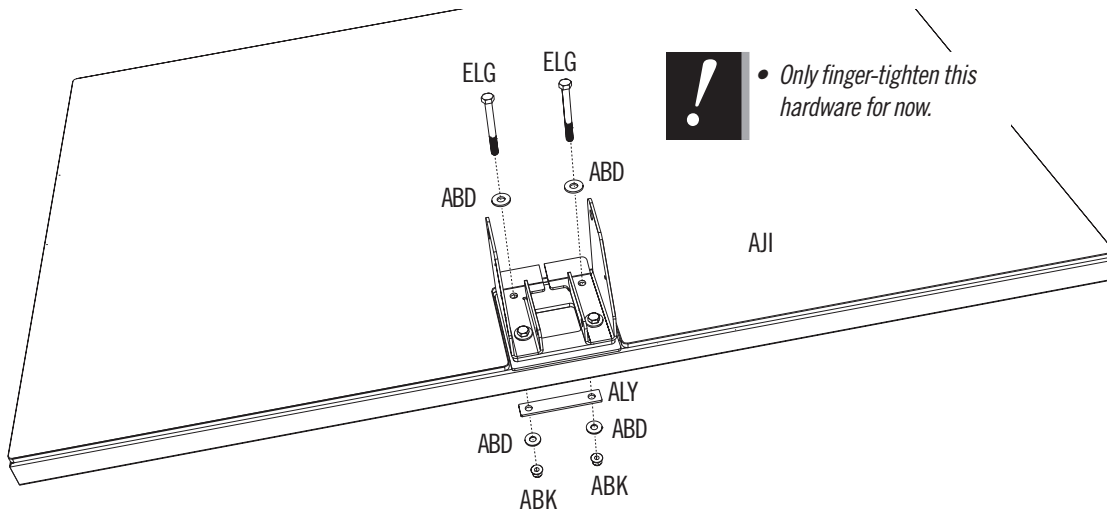

- Only finger-tighten this hardware for now.*

### 5.3

- Slide the end of the **rim pin (BPZ)** into the **rim (ALX)** and through the **eye bolt (BQA)** in the location indicated. Attach the rim to the rim housing using the hardware shown, making sure the **washers (ANK)** rest between the rim and the rim housing.

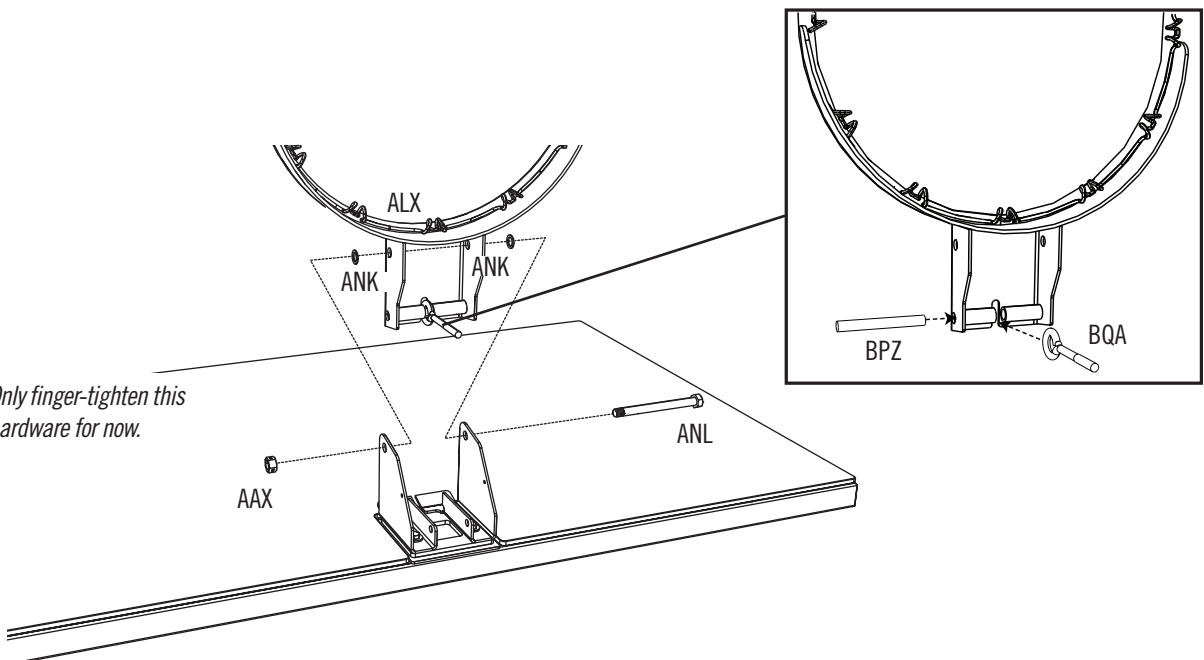

- Only finger-tighten this hardware for now.*



## ► SECTION 5 (CONTINUED)

TOOLS AND HARDWARE REQUIRED

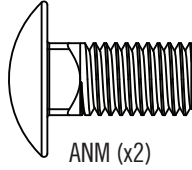
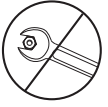

ANM (x2)



ABB (x2)



ANK (x2)

### 5.4

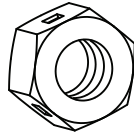
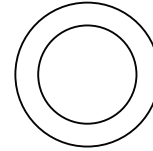
- Slide the **spring holder clevis (AMK)** onto the **eye bolt (BQA)** and secure with the hardware shown.

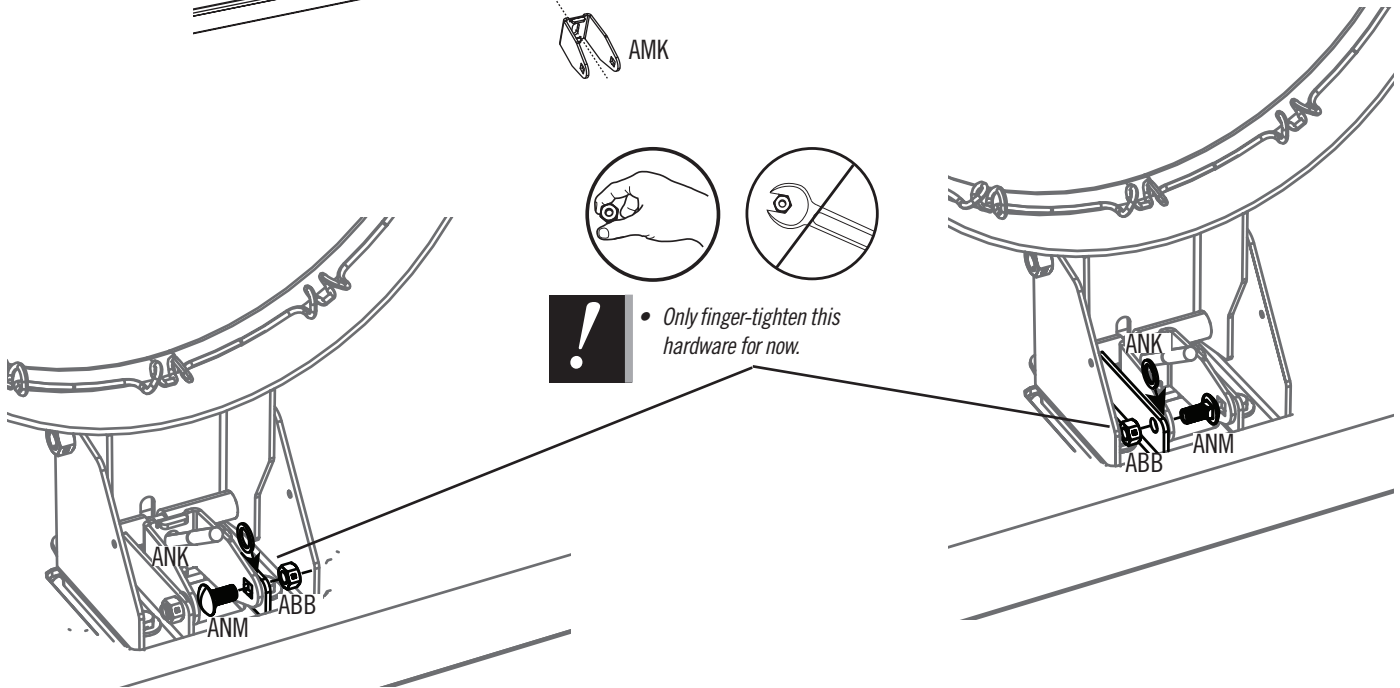
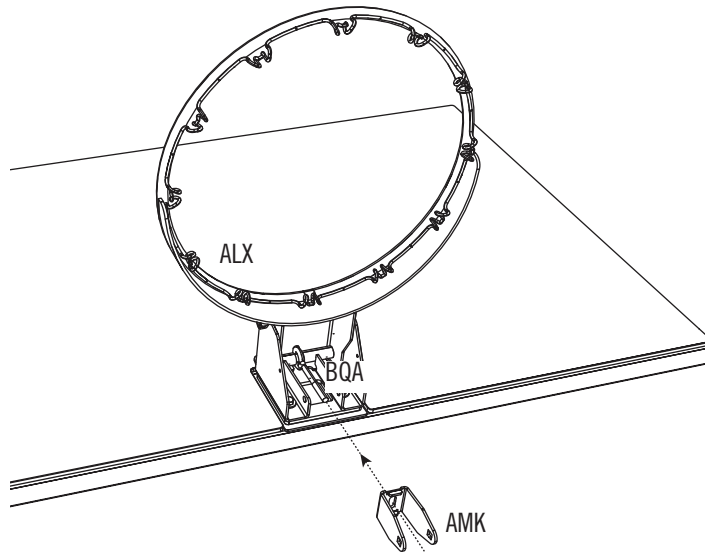

## SECTION 5 (CONTINUED)

### TOOLS AND HARDWARE REQUIRED

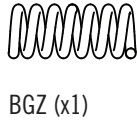
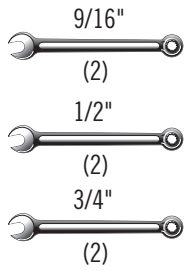

## 5.5

- Slide the **compression spring (BGZ)** onto the **eye bolt (BQA)**, and secure with the hardware shown. Tighten the **nuts (ANN)** to adjust rim tension.

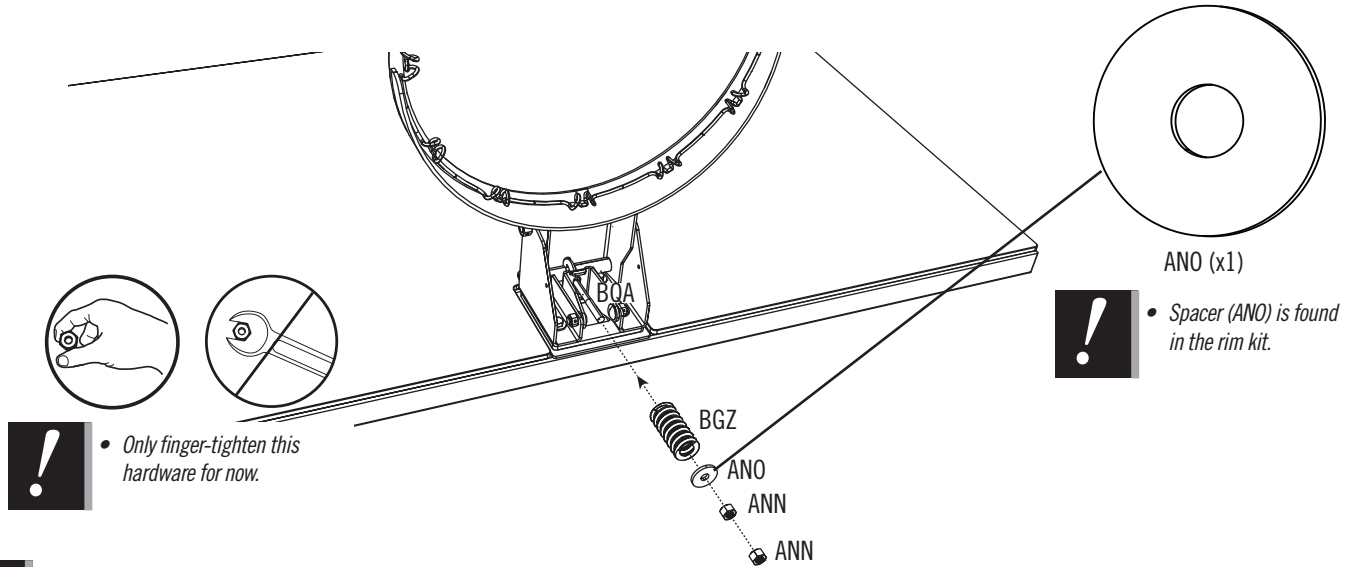

## 5.6

- Secure the hardware from steps 5.1–5.5 in the order they were assembled.

### 5.1

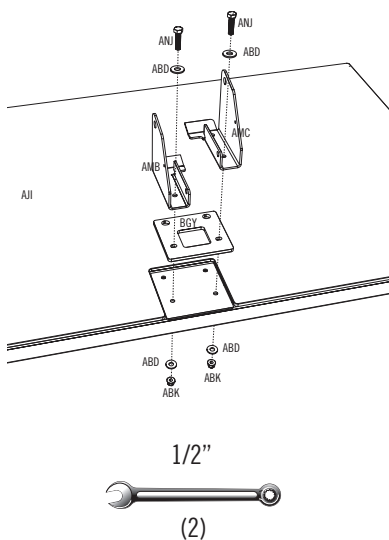

### 5.2

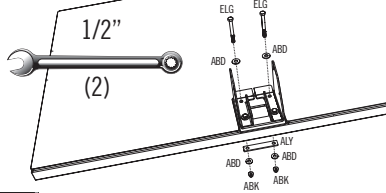

### 5.3

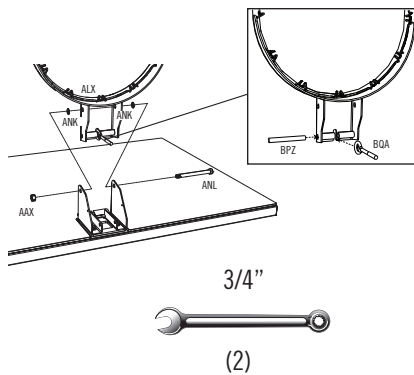

### 5.4

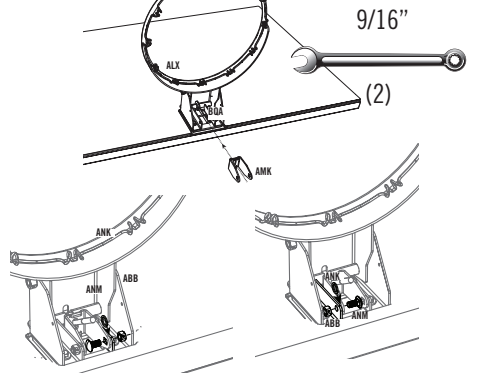

### 5.5

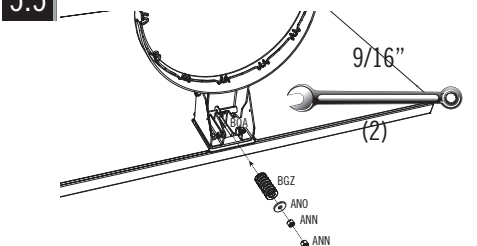

## ► SECTION 5 (CONTINUED)

TOOLS AND HARDWARE REQUIRED



(1)

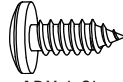

ADX (x2)

### 5.7

- Attach the **Rim Cover Plate (AMA)** to the Rim with the hardware shown.

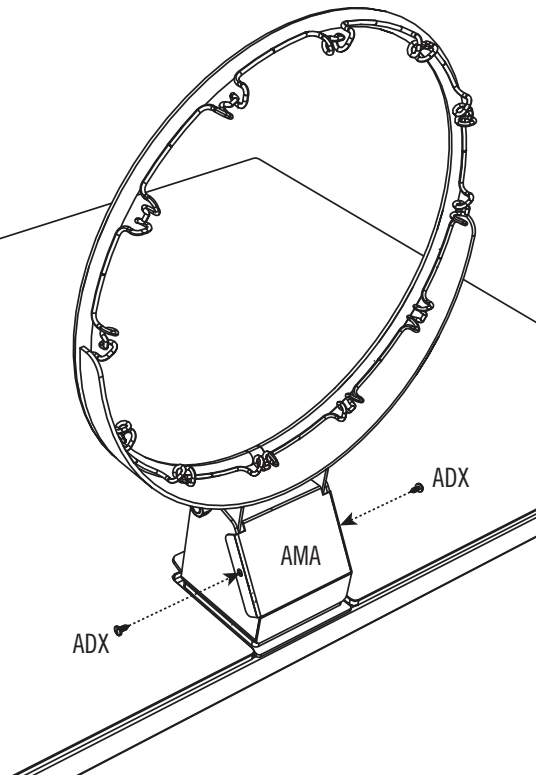
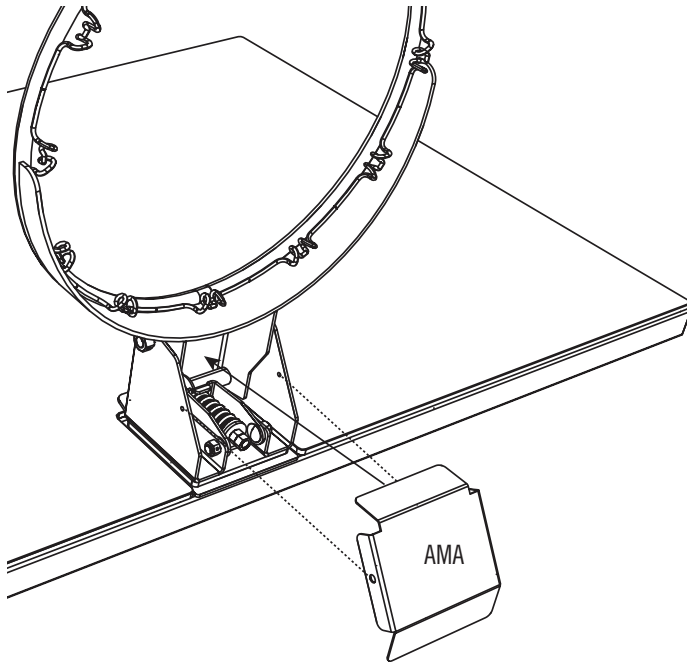

# 6

## BACKBOARD-TO-POLE ASSEMBLY



### HARDWARE REQUIRED

Hardware Blister Pack

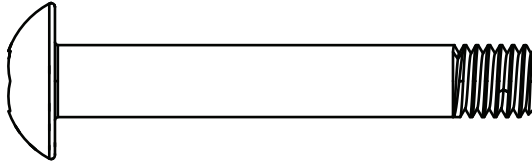
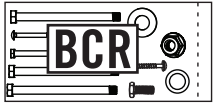

EKM (x4)

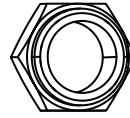

CUB (x4)

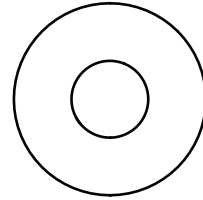

EJH (x12)



### PARTS REQUIRED

*NO NEW PARTS ARE REQUIRED FOR THIS SECTION*



### TOOLS REQUIRED



9/16"



5/16"

## ► SECTION 6 (CONTINUED)

TOOLS AND HARDWARE REQUIRED



9/16"



5/16"

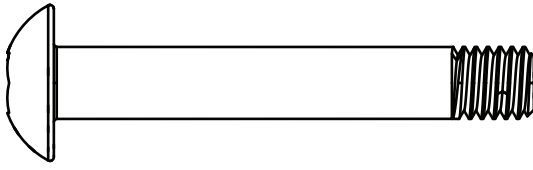

EKM (x2)

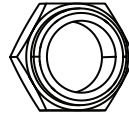

CUB (x2)

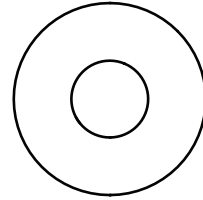

EJH (x6)

**CAUTION: AT LEAST TWO ADULTS ARE REQUIRED TO COMPLETE ASSEMBLY.**

**6.1**



**TO PREVENT SERIOUS INJURIES, THE POLE SHOULD BE HELD DOWN BY AT LEAST ONE ADULT AT ALL TIMES.**



- Attach the **lower extension arms (AKE)** to the **backboard (AJI)** using the hardware shown.

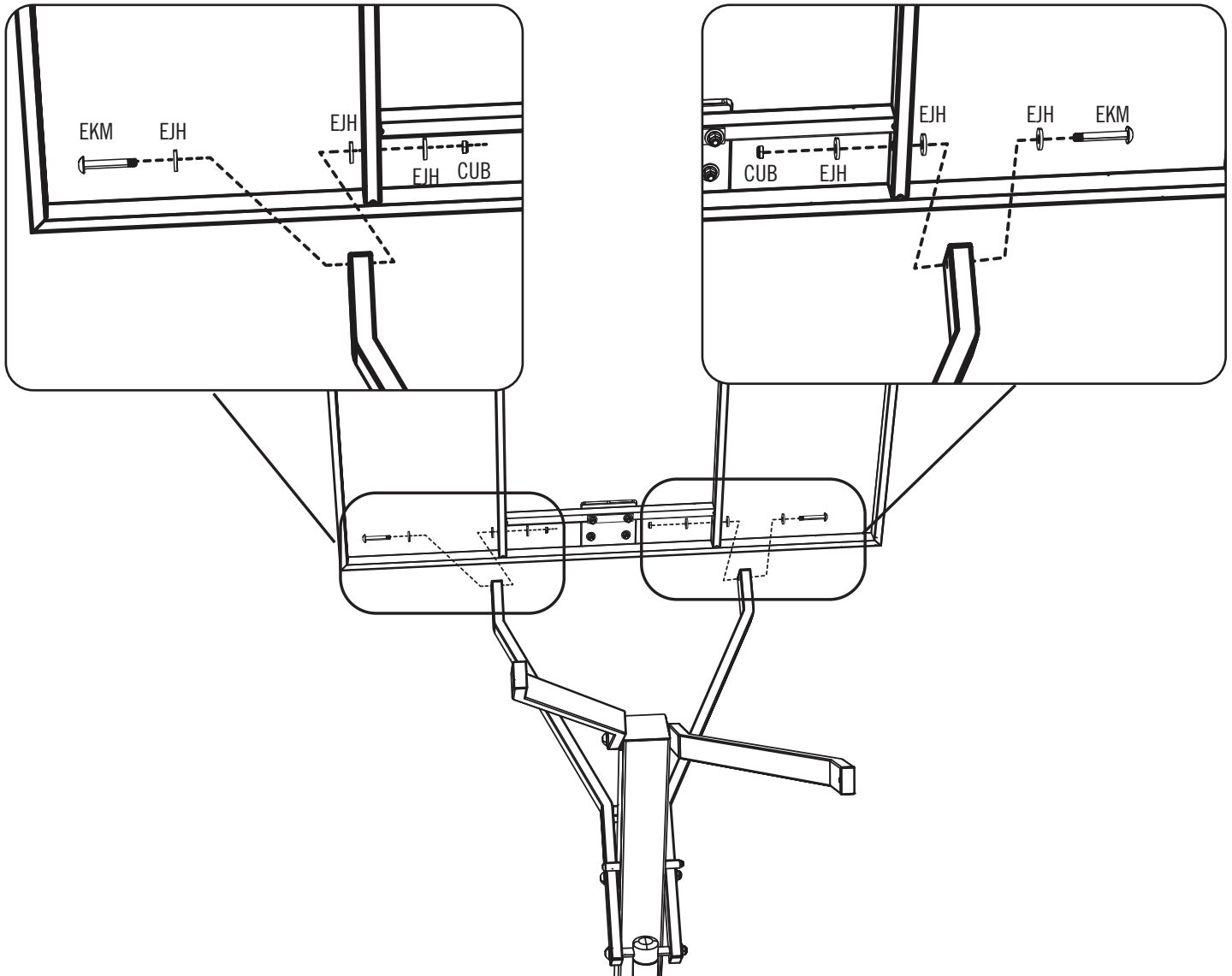

## SECTION 6 (CONTINUED)

TOOLS AND HARDWARE REQUIRED



9/16"



5/16"

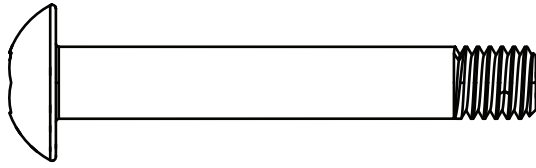

EKM (x2)

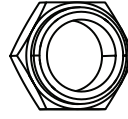

CUB (x2)

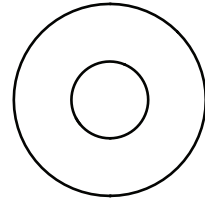

EJH (x6)

# 6.2

- Attach the **upper extension arm (AKD)** to the **backboard (AJI)** using the hardware shown.

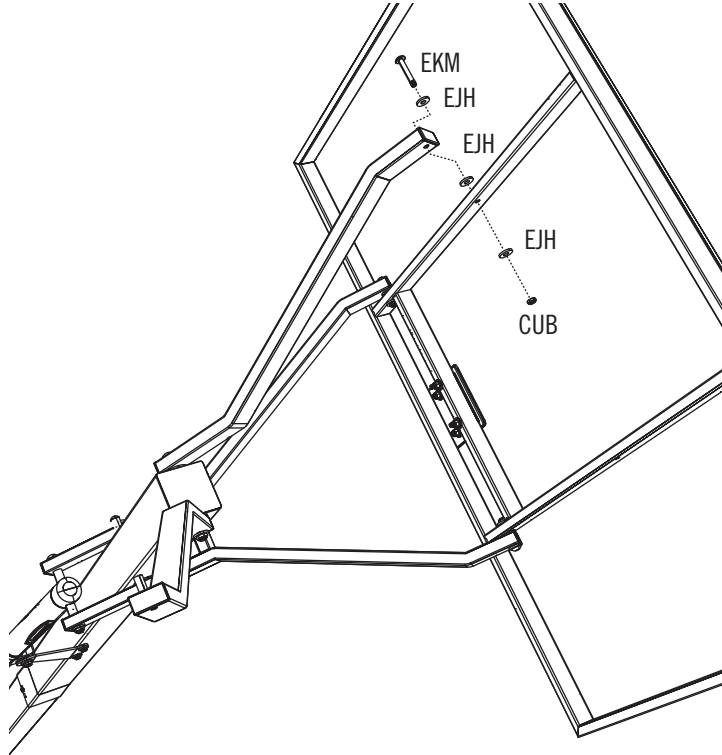

# 6.3

- Repeat step 6.2 to attach the remaining upper extension arm to the backboard.

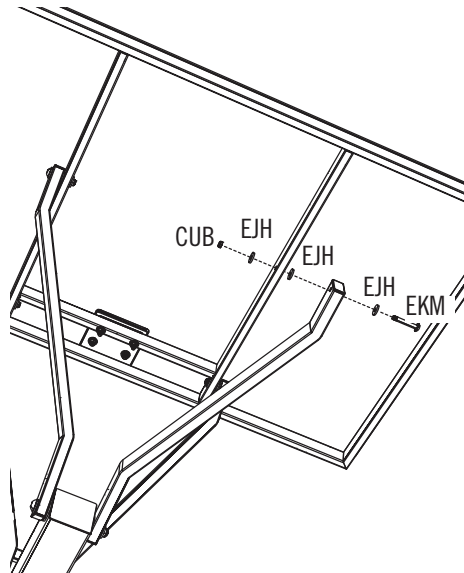

# 7

## FINAL ASSEMBLY



### HARDWARE REQUIRED

Hardware Blister Pack

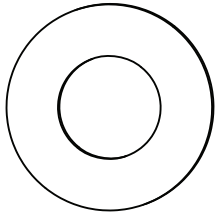

AOR (x4)

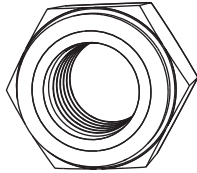

ADM (x4)

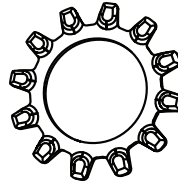

AQN (x4)

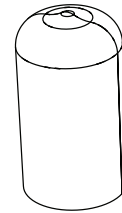

AQO (x4)



### PARTS REQUIRED



• **DO NOT PROCEED** with this Section until the concrete from Section 1 has been allowed to cure at least 72 hours (3 days).

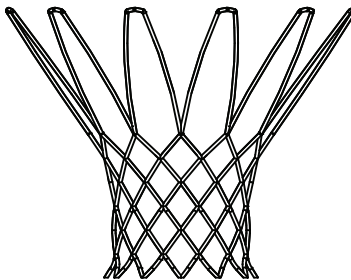

AKZ (x1)



AKP (x1)



### TOOLS REQUIRED

3/4"



(x1)

Carpenter's Level



(x1)

## ► SECTION 7 (CONTINUED)

TOOLS AND HARDWARE REQUIRED



3/4"

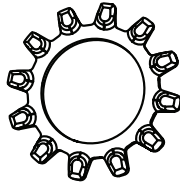

AQN (x4)



DO NOT PROCEED WITH THIS SECTION UNTIL THE CONCRETE FROM SECTION 1 HAS BEEN ALLOWED TO CURE AT LEAST 72 HOURS (3 DAYS).

### 7.1

- Stack a **star washer (AQN)** onto the exposed ends of the **J-bolts (AEI)**.

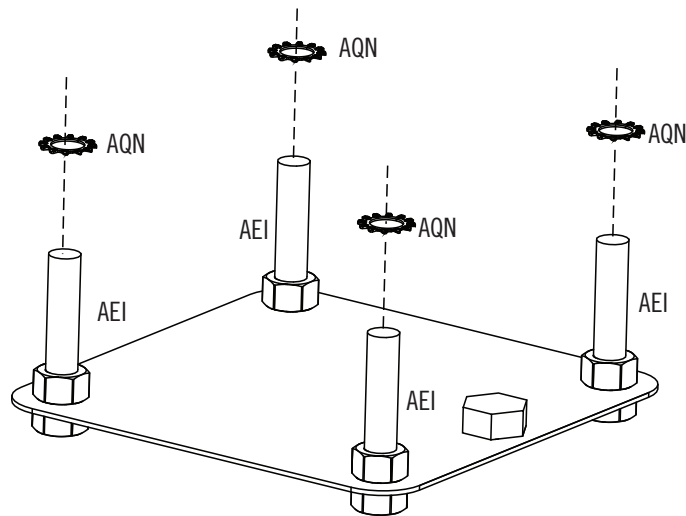

### 7.2

- Attach the **net (AKZ)** to the **rim (ALX)**.

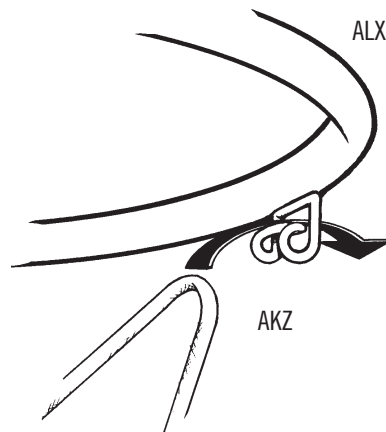

- If a replacement net is needed, please call our Customer Service Department. Our nets are shorter than average to reduce the risk of entanglement.



## ► SECTION 7 (CONTINUED)

TOOLS AND HARDWARE REQUIRED



### 7.3

- Position the pole so the slots in the plate at the bottom of the pole align with the two J-bolts closest to the playing surface. Push the plate against the bolts, ensuring the slots are aligned exactly with the bolts. With the system adjusted to its lowest position, have **at least three adults** slowly and carefully lift the pole so the bolts slide through the slots. Align the holes at the back of the plate with the bolts at the back of the template, and stand the system completely upright.

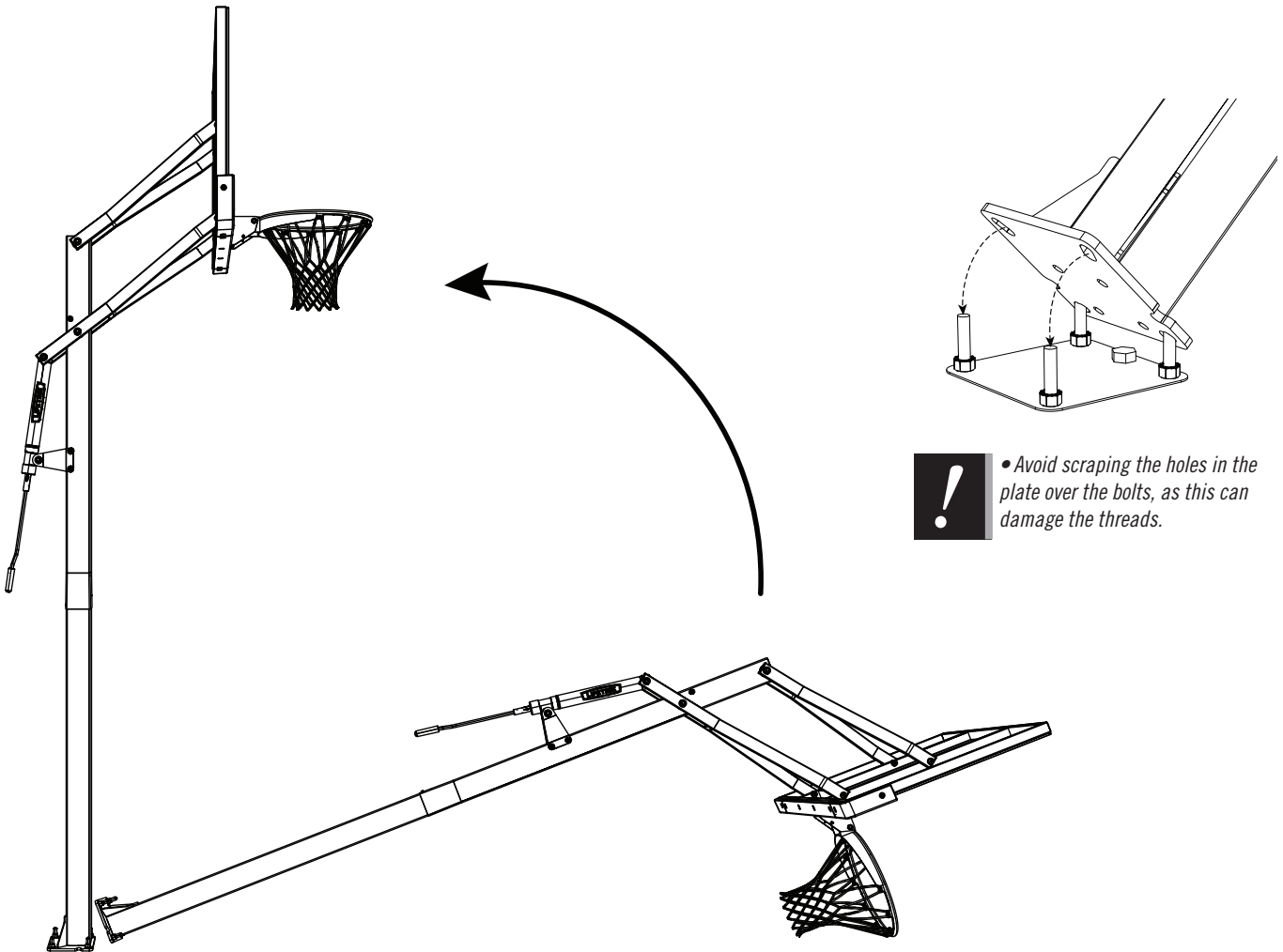

- **!** Avoid scraping the holes in the plate over the bolts, as this can damage the threads.



**WARNING:** The assembled system is very heavy. At least three adults are required to complete these steps. Keep hands and fingers clear of pinch points. Do not put hands or fingers between the pole and the mounting plate at any time. Stand the pole up slowly and carefully. Failure to follow all of these instructions and warnings could lead to property damage or serious personal injuries.

## ► SECTION 7 (CONTINUED)

### TOOLS AND HARDWARE REQUIRED



3/4"

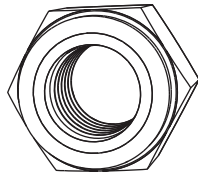

ADM (x4)

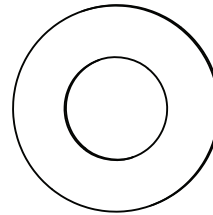

AOR (x4)

# 7.4

- At least two people should support the pole as one person slides a **washer (AOR)** onto to the end of each J-bolt and secure the pole into position with a **nut (ADM)**.

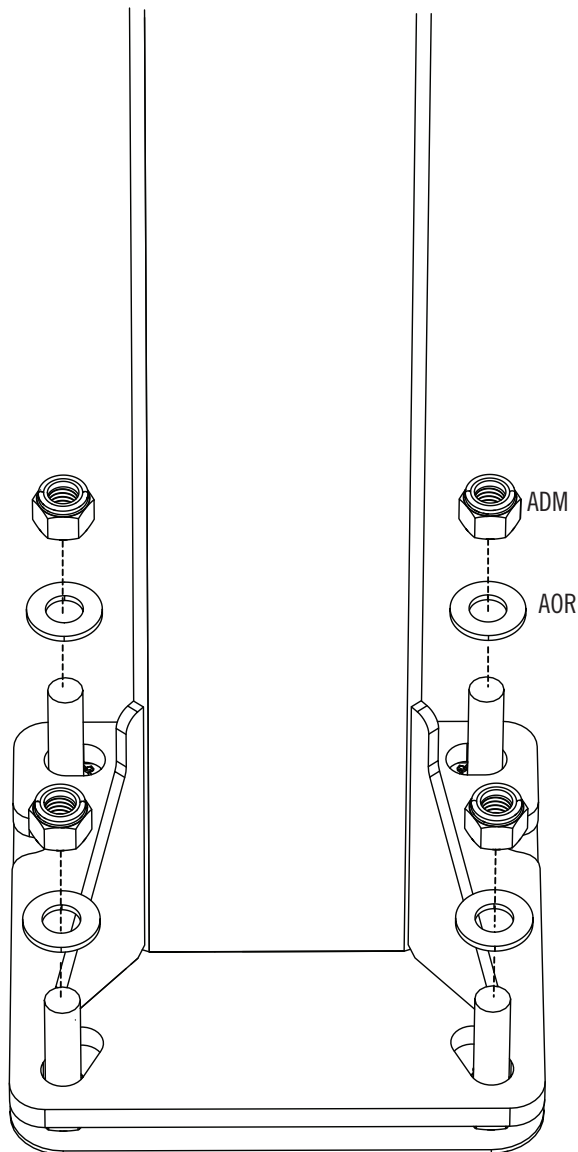

# 7.5

### A MINIMUM OF THREE ADULTS ARE REQUIRED FOR THIS STEP.

- Two adults should continue supporting the pole. Using a carpenter's level on the face and the side of the backboard, adjust the hex nuts between the template and the pole plate until the pole plate is resting level on all four nuts, with the backboard hanging plumb.

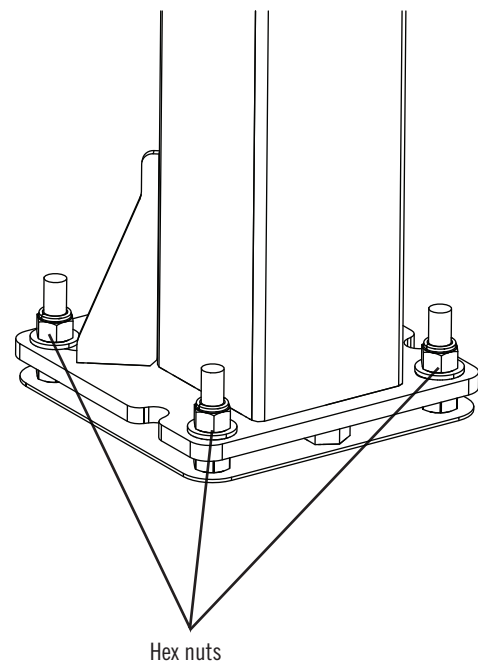

- *Ensure the bottom and side edges of the backboard are level and perpendicular to the playing surface.*

## ► SECTION 7 (CONTINUED)

TOOLS AND HARDWARE REQUIRED

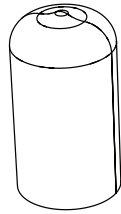

AQQ (x4)

### 7.6

- Tighten the four **hex nuts (ADM)** above the plate at the top of the pole plate until they are secure against the plate, ensuring the backboard remains vertical.

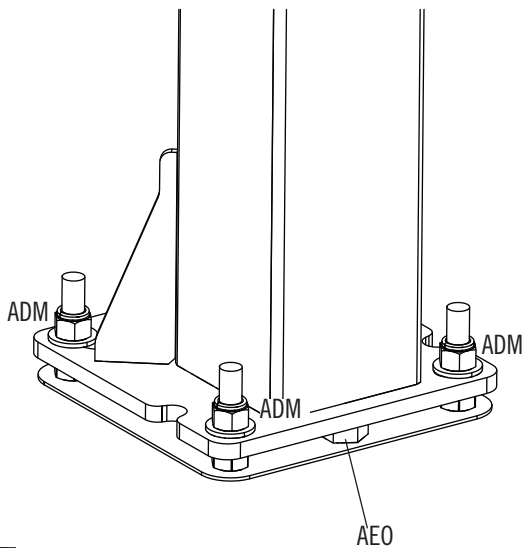

### 7.7

- Place a **plastic cap (AQQ)** onto each J-bolt.

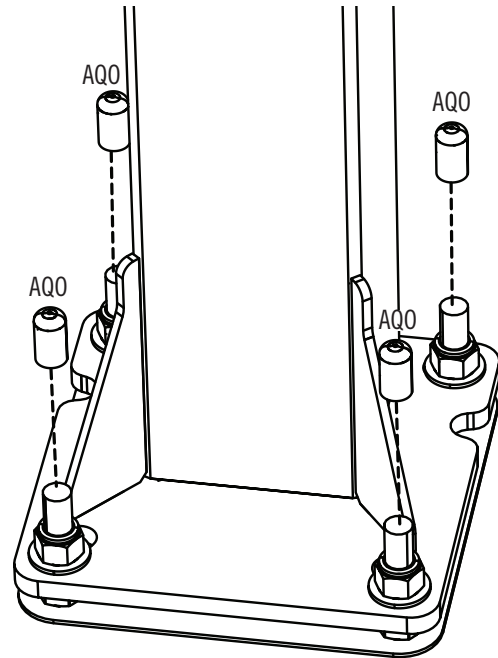

### 7.8

- Lower the backboard until the top of the rim is 7'-6" above the playing surface. Remove about an inch of backing from the top of the **height sticker (AKP)**. Apply the sticker to the back of the crank mechanism, lining up the top of the sticker with the crank adjust cover. To prevent wrinkles, press the sticker into place while slowly removing the rest of the backing.

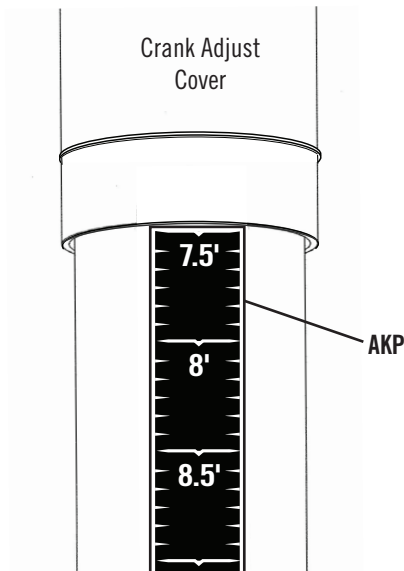

- *Height Sticker may be different than the one shown here.*



## MAINTENANCE INSTRUCTIONS

The life of your basketball system depends on many variables. The climate, exposure to corrosives such as salt, pesticides, or herbicides, and excessive use or misuse can all contribute to Pole failure, which may cause property damage or personal injury.

Check your basketball system frequently for loose hardware, excessive wear, and signs of corrosion. For safety reasons, and to prolong the life of your basketball system, you must take the following preventive measures.

- a. Check all Nuts and Bolts. If any are loose, tighten them.
- b. Check all parts for excessive wear and tear. If necessary, replace any parts that have been worn or damaged through usage. Contact our Customer Service Department for replacement parts.
- c. Inspect the Warning Sticker on the Pole. If it is ripped, faded, or illegible, call our Customer Service Department to request a replacement Sticker.
- d. Check all Pole sections for visible rust or chipped or cracked paint. If either are present, do the following:
  1. Use an emery cloth to completely remove any rust or chipped paint.
  2. Clean the area with a damp cloth and allow it to dry.
  3. Apply two coats of a rust preventative, high gloss enamel paint to the area. Allow the paint to dry between coats.

**IF RUST HAS PENETRATED THROUGH THE POLE ANYWHERE, REPLACE IT IMMEDIATELY!**



## REGISTER YOUR PRODUCT ONLINE AT [WWW.LIFETIME.COM](http://WWW.LIFETIME.COM)

At Lifetime®, we are committed to providing innovative and quality products. While registering, you will have the opportunity to give us your feedback. Your input is valuable to us.

- You can also opt in to receive new product notifications or promotions.
- In the unlikely event of a product recall or safety modification, your registration provides the information we need to notify you directly.
- Registration is fast, easy, and completely voluntary.

### **LIFETIME'S PROMISE TO YOU:**

*Maintaining your privacy is our long-standing policy at Lifetime®. And you can rest assured that Lifetime® will not sell or provide your personal data to other third parties, or allow them to use your personal data for their own purposes.*

We invite you to read our privacy policy at [www.lifetime.com](http://www.lifetime.com)

**REGISTER today!**



# WARNING STICKER / AUTOCOLLANT D'AVERTISSEMENT / AUTOADHESIVO DE ADVERTENCIA

## WARNING

### FAILURE TO FOLLOW THESE WARNINGS MAY RESULT IN SERIOUS INJURY AND/OR PROPERTY DAMAGE.

Owners must ensure that all players know and follow these rules for safe operation of the system.

- Only hang from the Rim briefly to regain balance or avoid injuring others. Release the Rim as soon as safely possible.
- During play, especially when performing dunk type activities, keep player's face away from the Backboard, Rim, and Net. Serious injury could occur if teeth/face come in contact with the Backboard, Rim, or Net. Player should wear a mouth guard during play.
- Do not slide, climb, or play on Base or Pole.
- When adjusting height or moving system, keep hands and fingers away from moving parts.
- Do not allow children to move or adjust system.
- Do not wear jewelry (rings, watches, necklaces, etc.) during play. Objects may entangle in Net.
- Keep water and organic material away from Pole Base. Grass, litter, etc. could cause corrosion and/or deterioration.
- Never play on damaged equipment.
- Once a month check Pole and all metal parts for signs of corrosion (rust, pitting, chipping). Completely remove rust and repaint with exterior enamel. If rust has penetrated any steel part, replace that part immediately.



- Check system before each use for proper ballast, loose hardware, excessive wear, instability, and signs of corrosion and repair before use.
- Do not use the system to lift or hoist anything. The mechanism is designed to lift only the weight of the Backboard and Rim. Do not hang anything from the Handle, Rim, Backboard, or Lifter Arms as this will damage the system and void the warranty.

## AVERTISSEMENT

### FAUTE DE NE PAS SUIVRE CES AVERTISSEMENTS, VOUS RISQUEZ DE CAUSER DES BLESSURES GRAVES ET/OU DES DOMMAGES À L'ÉQUIPEMENT.

Le propriétaire doit s'assurer que tous les joueurs connaissent et appliquent les règles suivantes afin d'utiliser l'équipement en toute sécurité.

- Ne vous suspendez pas à l'anneau plus que nécessaire pour retrouver votre équilibre ou éviter de blesser les autres joueurs. Relâchez l'anneau aussitôt que possible.
- Lors d'un match, particulièrement dans le cas des smashes, le visage du joueur ne doit pas faire face au panneau, à l'anneau, ni au filet. Le joueur risque de graves blessures si ses dents ou son visage entrent en contact avec le panneau, l'anneau, ou le filet. Les joueurs doivent toujours porter un protège-dents lorsqu'ils jouent.
- Ne glissez pas, ne grimpez pas, et ne jouez pas sur la base ou le poteau.
- Lorsque vous ajustez la hauteur ou lorsque vous déplacez l'équipement, gardez vos mains et doigts loin des pièces mobiles.
- Ne permettez pas aux enfants de déplacer ou d'ajuster l'équipement.
- Ne portez pas de bijoux (bagues, montres, colliers, etc.) lorsque vous jouez. Ces objets pourraient s'accrocher au filet.
- Gardez de l'eau et de la matière organique loin de la base. Le gazon, les déchets, etc. pourraient provoquer la corrosion et/ou la détérioration.
- Une fois par mois, vérifiez que le Poteau et toutes les pièces en métal ne montrent pas de signes de corrosion (rouille, piqûres, écaillage). Enlevez toute la rouille et repeignez complètement avec une peinture pour extérieur. Si la rouille a pénétré une des pièces en acier, vous devez remplacer immédiatement la pièce en question.
- A chaque fois que vous allez utiliser l'équipement, vérifiez d'abord l'équilibre, la possibilité de pièces desserrées ou usées, la stabilité de l'équipement et tout signe de corrosion ou réparation nécessaire avant utilisation.
- Ne jouez jamais avec un équipement endommagé.
- N'utilisez pas l'équipement pour lever ou soulever quoique ce soit. Son mécanisme a été conçu uniquement pour soutenir le poids du panneau et de l'anneau. N'accrochez rien au manche, à l'anneau, au panneau ni aux leviers sous peine d'endommager l'équipement et d'annuler la garantie.

## ADVERTENCIA

### SI NO SE OBEDECEN ESTAS ADVERTENCIAS PUEDEN PRODUCIRSE GRAVES LESIONES Y/O DAÑOS A LA PROPIEDAD.

El propietario del sistema debe asegurarse de que todos los jugadores conozcan y respeten estas reglas para que el sistema se use en forma segura.

- Cuélguese del aro sólo en forma breve, para recuperar el equilibrio o evitar lesionar a otros jugadores. Suéltese del aro lo más pronto que pueda hacerlo con seguridad.
- Durante el juego, especialmente al embocar violentamente de alto, la cara de los jugadores debe mantenerse alejada del tablero, el aro y la red. Pueden producirse lesiones graves si los dientes o la cara entran en contacto con el tablero, el aro o la red. Los jugadores deben usar un protector bucal durante el juego.
- No se deslice, no trepe ni juegue sobre la base o el poste.
- Mantenga las manos y los dedos alejados de las piezas móviles cuando regule la altura o desplace el sistema.
- No deje que los niños regulen ni desplacen el sistema.
- No use joyas (anillos, relojes, collares o gargantillas, etc.) durante el juego. Estos objetos pueden engancharse en la red.
- Guarde agua y materia orgánica. Césped, basura, etc., podrían causar corrosión et/o deterioros.
- Controle el poste y todas las piezas metálicas una vez al mes en busca de signos visibles de corrosión (oxidación, picaduras, escamado). Elimine todo rastro de óxido y vuelva a pintar con esmalte para exteriores. Si el óxido ha penetrado cualquier pieza de acero, reemplace esa pieza de inmediato.
- Inspeccione el sistema antes de cada uso para verificar que esté adecuadamente contrapesado, que los elementos de fijación no estén flojos, que no haya desgaste excesivo, inestabilidad ni signos de corrosión. Si encuentra irregularidades, repárelas antes de usar el sistema.
- Nunca juegue con un equipo dañado.
- No use el sistema para levantar ningún objeto. El mecanismo está diseñado para elevar solamente el peso del tablero con el aro. No cuelgue nada de la agarradera, el aro, el tablero ni los brazos de elevación, ya que esto puede dañar el sistema y anular la garantía.



## 5-YEAR LIMITED FACTORY WARRANTY

### THE MANUFACTURER RESERVES THE RIGHT TO MAKE SUBSTITUTIONS TO WARRANTY CLAIMS IF PARTS ARE UNAVAILABLE OR OBSOLETE.

1. Lifetime basketball systems are warranted to the original purchaser to be free from defects in material or workmanship for a period of five years from the date of original retail purchase. The word “defects” is defined as imperfections that impair the use of the product. Defects resulting from misuse, abuse or negligence will void this warranty. This warranty does not cover defects due to improper installation, alteration or accident. This warranty does not cover damage caused by vandalism, rusting, “acts of nature” or any other event beyond the control of the manufacturer.
2. This warranty does not cover breakage of the tempered glass playing surface.
3. This warranty is nontransferable and is expressly limited to the repair or replacement of defective product. If the product is defective within the terms of this warranty, Lifetime Products, Inc. will repair or replace defective parts at no cost to the purchaser. Shipping charges to and from the factory or distribution center are not covered and are the responsibility of the purchaser. Labor charges and related expenses for removal, installation or replacement of the basketball system or its components are not covered under this warranty.
4. This warranty does not cover scratching or scuffing of the product that may result from normal usage. In addition, defects resulting from intentional damage, negligence, unreasonable use or hanging from the rim will void this warranty.
5. Liability for incidental or consequential damages is excluded to the extent permitted by law. While every attempt is made to embody the highest degree of safety in all equipment, freedom from injury cannot be guaranteed. The user assumes all risk of injury resulting from the use of this product. All merchandise is sold on this condition, and no representative of the company may waive or change this policy.
6. This product is not intended for institutional or commercial use; Lifetime Products, Inc. does not assume any liability for such use. Institutional or commercial use will void the warranty.
7. Our goods come with guarantees that cannot be excluded under the Australian Consumer Law. You are entitled to a replacement or refund for a major failure and for compensation for any other reasonably foreseeable loss or damage. You are also entitled to have the goods repaired or replaced if the goods fail to be of acceptable quality and the failure does not amount to a major failure.
8. This warranty is expressly in lieu of all other warranties, expressed or implied, including warranties of merchantability or fitness for use to extent permitted by Federal and state law. Neither Lifetime Products, Inc., nor any representative assumes any other liability in connection with this product. This warranty gives you specific legal rights, and you may also have other rights which vary from state to state.

### PLEASE INCLUDE YOUR DATED SALES RECEIPT AND PHOTOGRAPHS OF DAMAGED PARTS.

#### REPORT PRODUCT DEFECTS IN WRITING TO:

Lifetime Products, Inc., PO Box 160010 Clearfield, UT 84016-0010  
or call 1-800-225-3865 M-F 7 a.m. to 5 p.m. MST.

### REGISTER YOUR PRODUCT FOR QUICKER CUSTOMER SERVICE.

Visit [www.lifetime.com](http://www.lifetime.com) or call 1-800-225-3865 to register your product today.

### FOR INTERNATIONAL WARRANTY CLAIMS:

All warranty claims must be accompanied by a sales receipt. Report all warranty claims in writing to your regional sales support representative. Please include your dated sales receipt and photographs of damaged parts. To identify the representative for your region, please visit: [www.lifetime.com/international](http://www.lifetime.com/international)



[www.lifetime.com](http://www.lifetime.com)

**ENHANCE YOUR LIFETIME® PURCHASE BY ADDING ACCESSORIES OR OTHER GREAT PRODUCTS**

*To purchase accessories or other Lifetime® products, visit us at:*

***www.lifetime.com***

*Or call: 1-800-424-3865*

*7:00 am–5:00 pm (M–F) MST and 9:00 am–1:00 pm Saturday MST*



**www.lifetime.com**

