



20W DALI-2 'Dim to Dark' LED Driver

SOLOdrive

LED dimming made beautiful - SOLOdrive offers industry-best Natural Dimming to dark, with any dimmer, in any application. The SOLOdrive works seamlessly with LED modules, controls and intelligent luminaire elements.

Product offering



SOLOdrive 20M-E2Z0D

Part number (P/N)	SL20M-E2Z0D1
Product description	SOLOdrive, 20W, DALI-2, 1 control channel, constant current, 2x 40V output, side feed, long plastic

Features & benefits

Natural dimming	Dim to dark, smooth brightness changes, excellent flicker performance, adaptable dimming curves, configurable minimum dimming level
LightShape	Dim to Warm: decrease colour temperature when dimming
LEDcode	LEDcode2 connects to integrated digital accessories, supports location-based IoT applications and enables wired and wireless lighting control through LEDcode peripheral devices
Programmable	Fine-tune your driver for any application
Performance	Low inrush current and total harmonic distortion (THD), high power factor and efficiency
Camera compatibility	Hybrid HydraDrive technology is proven to work in TV studios and security camera environments

Programming tools

Programming interface	TOOLbox pro (TLU20504)
Programming cable set	TOOLbox pro to LED driver, programming cable, 5pcs (TLC03051)
Programming Hand-held, Touch-and-Go	PJ0035HH1
Programming jig	PJ0202A1
Programming software	FluxTool

Warranty

Warranty period	General Terms and Conditions
-----------------	--

Order number configurator

<p>Standard</p>	<p>SL20M-E2Z0D1 Part Number</p>	<p>□□□□ mA LED Output Current</p>	<p>□□□ Dimming Curve</p>	<p>□□.□ min Minimum Dimming Level</p>		
<p>Multi-Current</p>	<p>SL20M-E2Z0D1 Part Number</p>	<p>M C U R LED Output Current</p>	<p>□□□ Dimming Curve</p>	<p>□□.□ min Minimum Dimming Level</p>	<p>CH1 - □□□□ mA LED Output 1</p> <p>CH2 - □□□□ mA LED Output 2</p>	
<p>LightShape</p>	<p>SL20M-E2Z0D1 Part Number</p>	<p>□□□□ mA LED Output Current</p>	<p>D T W LightShape Control Type</p>	<p>□□□ Dimming Curve</p>	<p>□□ - □□ K Gamut CCT</p>	<p>□□ - □□ lm Gamut Lumen Output</p> <p>□□ - □□ K Path CCT</p>
<p>LightShape Multi-Current</p>	<p>SL20M-E2Z0D1 Part Number</p>	<p>M C U R LED Output Current</p>	<p>D T W LightShape Control Type</p>	<p>□□□ Dimming Curve</p>	<p>CH1 - □□□□ mA LED Output 1</p>	<p>CH2 - □□□□ mA LED Output 2</p> <p>□□ - □□ K Gamut CCT</p> <p>□□ - □□ lm Gamut Lumen Output</p> <p>□□ - □□ K Path CCT</p>

Example: SL20M-E2Z0D1 MCUR DTW LOG CH1-300mA CH2-400mA 18-50K 10-12lm 18-50K

P/N	LED driver part number
LED output current, Standard	For models where output current is identical for all outputs. Enter value in 1mA increments, e.g. "811" for 811mA.
LED output current, Multi-Current	Output current different per output? Enter "MCUR" in LED output current and specify the differing currents in LED outputs 1 and 2. Note that cumulative current is limited.
LightShape control type	"DTW" stands for Dim to Warm
Dimming curve	"LOG" for logarithmic (default) "LIN" for linear
Minimum dimming level	Leave blank for default minimum dimming level of 0.1%. Specify in 0.1% increments, e.g. "10.5" for 10.5%.
Gamut CCT	LightShape-specific option. Enter the LEDs' CCT as "XX-YY" where XX is LED output 1 and YY is LED output 2. Available options per output: 18, 20, 22, 25, 27, 30, 35, 40, 50, 57 and 65. E.g. "18-50" for 1800K on LED output 1 and 5000K on LED output 2. Default is 27-65
Gamut lumen output	Enter the lumen output range for LED output 1 and 2 as "XX-YY" where XX is LED output 1 and YY is LED output 2. Available range per output: from "01" for 100lm to "99" for 9900lm. E.g. "10-12" for 1000lm on LED output 1 and 1200lm on LED output 2.
Path CCT	Leave blank if Path CCT requires the same values as Gamut CCT. Or specify the Path CCT values as "XX-YY" where XX is LED output 1 and YY is LED output 2. Available options per output: 18, 20, 22, 25, 27, 30, 35, 40, 50, 57, 65. E.g. "18-50" for 1800K on LED output 1 and 5000K on LED output 2.

Input characteristics

Nominal input voltage range	220 - 240 VAC (ENEC) 176 - 250 VDC
Absolute input voltage range	198 - 264 VAC
Input frequency range	50 - 60 Hz
Maximum input current	0.15A @ 230 VAC
Efficiency at full load	82%
Power factor at full load	> 0.9
THD at full load	< 20%
Maximum inrush current	< 200mA ² s @ 230 VAC
Surge protection	2kV differential mode (DM) 2kV common mode (CM)
Maximum standby power	0.5W

Output characteristics

Maximum LED output power	20W
Number of LED outputs	2
Programmable LED output current range	150 - 1050mA If $V_f < 20V$, the cumulative current of the two LED outputs shall not exceed 1050mA.
LED output type	Programmable in 1mA increments within specified current range
LED output current tolerance	+/- 5% at programmed LED output current
LED output voltage range	2 - 40V

Operating window

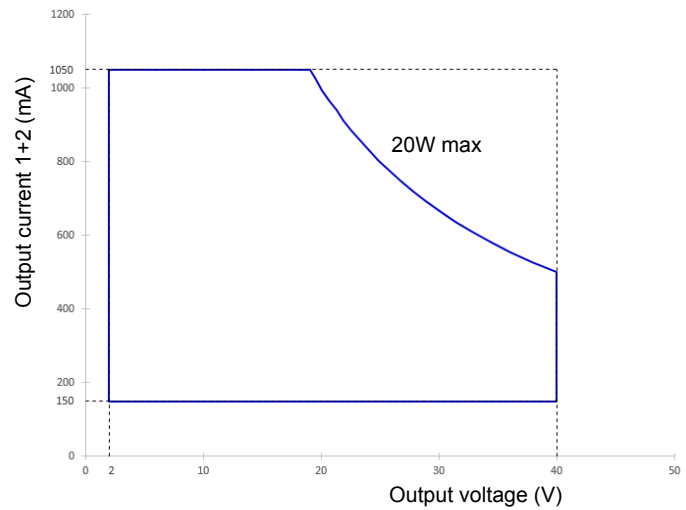

Control characteristics

Control channels	1
Control protocol	DALI-2 Device Type 6 LEDcode2
Dimming range	100% - 0.1%
Dimming curve options	Logarithmic (default) Linear
LightShape	Dim to Warm, 2x pc-white
Dimming method	Hybrid HydraDrive
Time delay to standby	< 30s

Dimming curves

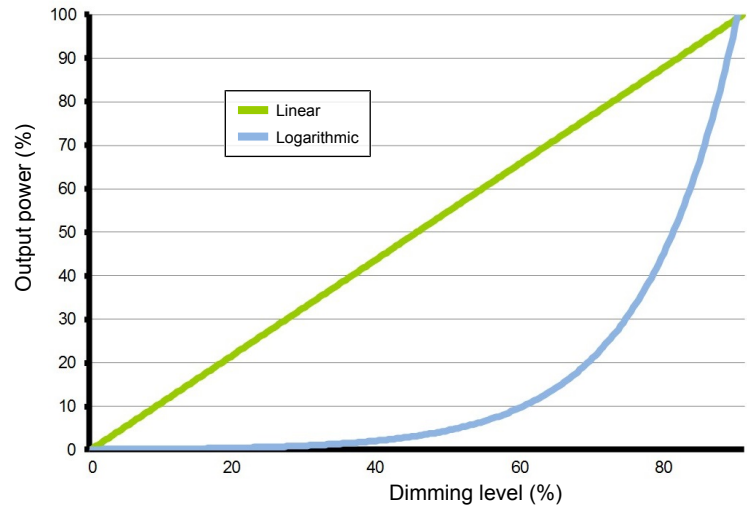

Performance

Typical efficiency vs load

Tested with a load on each LED output of 3 LEDs in series, programmed for 1050mA and at 25 °C ambient temperature. The measurements below 20W were performed by dimming the light output.

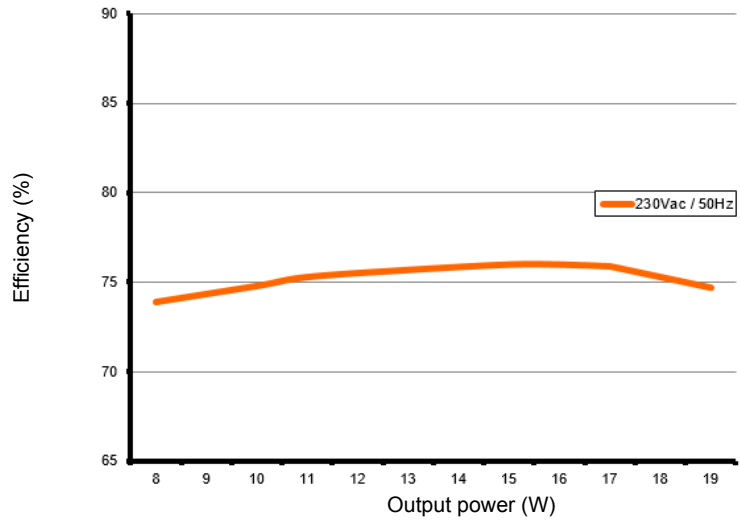

Typical power factor vs load

Tested with a load on each LED output of 3 LEDs in series, programmed for 1050mA and at 25 °C ambient temperature. The measurements below 20W were performed by dimming the light output.

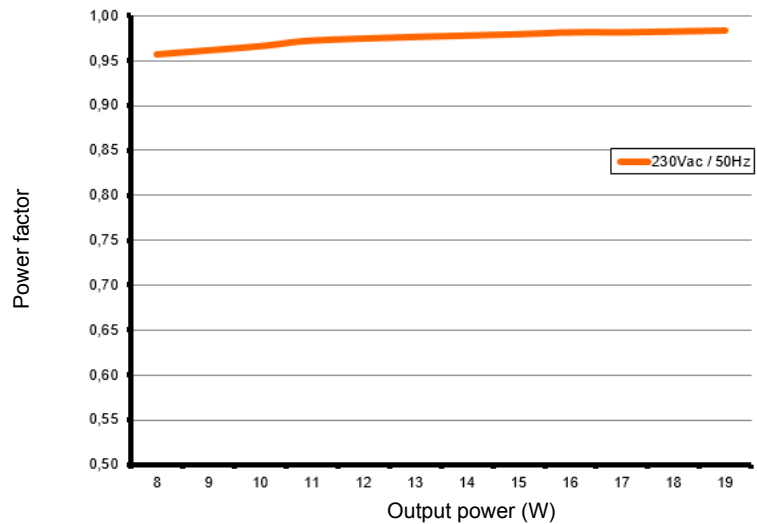

Typical THD vs load

Tested with a load on each LED output of 3 LEDs in series, programmed for 1050mA and at 25 °C ambient temperature. The measurements below 20W were performed by dimming the light output.

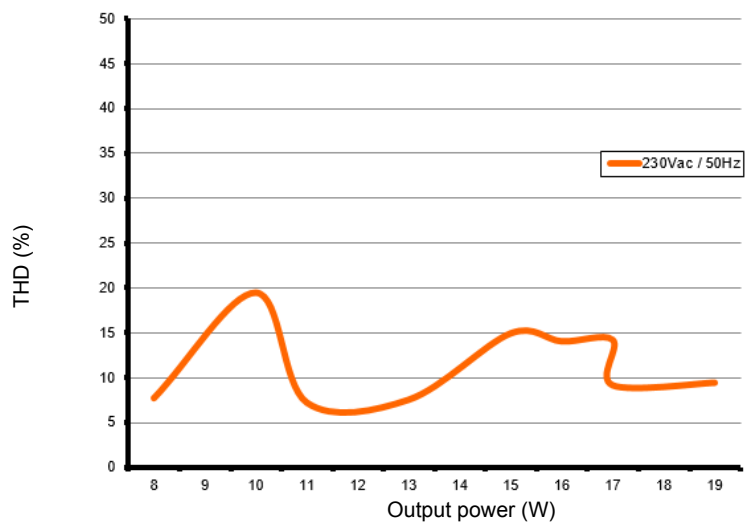

Typical flicker performance

Typical flicker percent as a function of frequency, measured across the dimming range. The results are overlaid with the low-risk (yellow) and no observable effect (green) levels as defined in IEEE P1789.

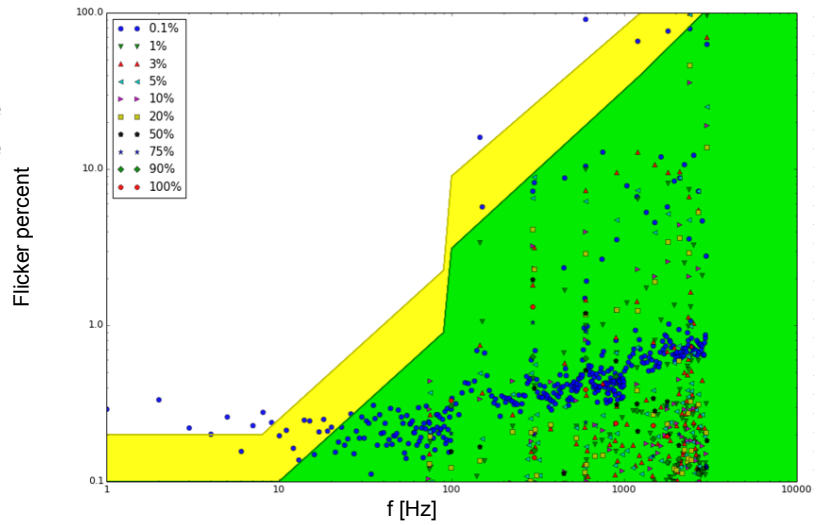

Environmental conditions

Operating ambient temperature (Ta) range -20 °C to +50 °C

Maximum operating case temperature (Tc max) 77 °C

Acoustic noise – steady state <24dBA (Class A)

Lifetime 50,000 hours at a maximum case temperature (Tc) of 77 °C

Tc point location

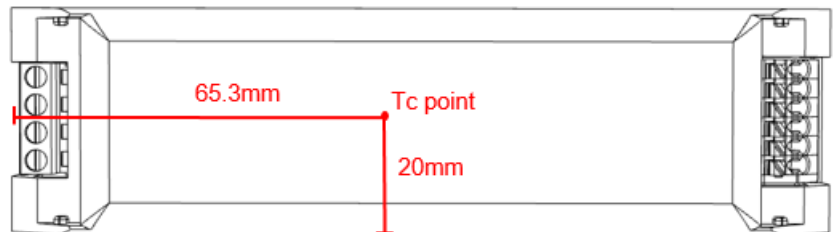

LED driver protection

Thermal	The LED output current is automatically decreased whenever the internal driver temperature exceeds a factory preset temperature. The LED output current is increased once the internal driver temperature drops below the preset temperature threshold. If the internal driver temperature continues to increase, despite a decrease in output current, the LED driver will eventually shut down.
LED output short circuit	The LED output current is cut off whenever the LED driver detects a short-circuit. The LED driver will attempt a restart every 400ms after a short-circuit is detected.
LED output open circuit	All LED outputs are turned off whenever the LED driver detects an open circuit on any one of the LED outputs. The LED driver will automatically attempt a restart every 400ms after an open circuit is detected.
LED output overload	The driver monitors the cumulative load across all LED outputs. Whenever this cumulative load exceeds the maximum output power rating of the LED driver, the output current on all LED outputs is sequentially scaled down until the cumulative load drops below the maximum output power rating of the LED driver.
Reverse polarity	The LED driver will not yield any current if the polarity of the load on the LED output is reversed. This situation will not damage the LED driver but may damage the LED load.

LED protection

Thermal protection LED	An external NTC thermistor, which is placed on a PCB near the LEDs, can be connected to the driver via the LEDcode/NTC terminals. The output current to the LEDs is then decreased by 75% whenever the NTC exceeds a maximum allowable temperature, which is specified by the user in the FluxTool software. The default NTC temperature limit is set to 70 °C.
Thermistor value	47kΩ
Suitable thermistors	Leaded: Vishay, P/N 238164063473 Screw: Vishay, P/N NTCASCWE3473J

LED driver mechanical details

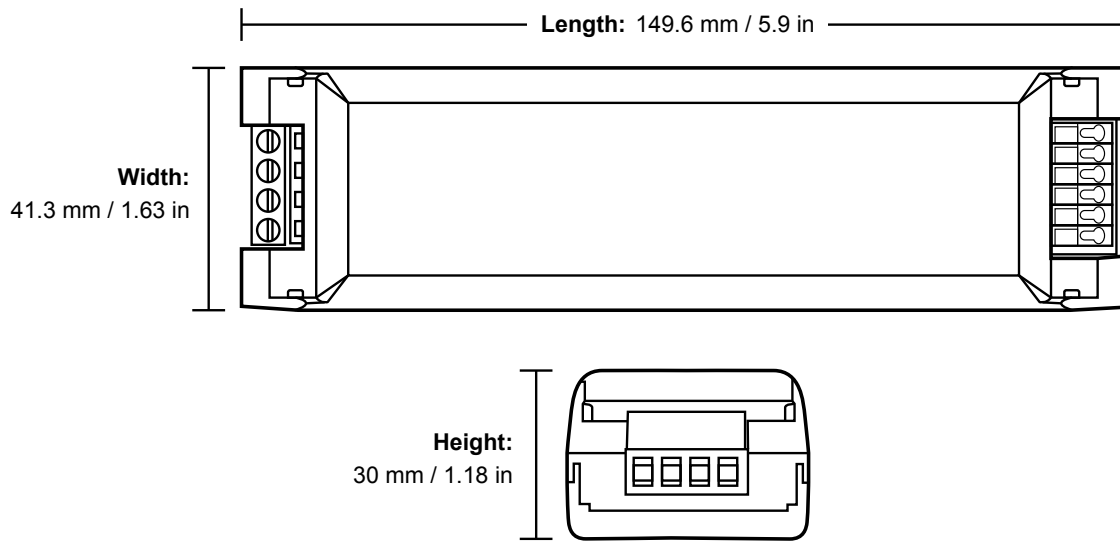

Weight 117.24 g

3D Mechanical files for this product are available on the eldoLED website.

Packaging

Length x Width x Height 579 x 237 x 202 mm / 22.8 x 9.33 x 7.95 in

Weight (including products) 10.5 kg

Products per box 50 pcs

Connector layout



Input wiring specifications

Connector type	screw terminals
Connector supplier and series	TE-Connectivity 2-796683
Wire type	solid or stranded copper
Wire core cross section	0.5 - 3mm ² / AWG 20 - 12
Wire core cross section for RCM	0.75 - 3mm ² / AWG 18 – 12
Wire strip length	9.0mm (11/32in)

Output wiring specifications

Connector type	push-in terminals
Connector supplier and series	Wago 250 series
Wire type	solid or stranded copper
Wire core cross section	0.5 - 1.5mm ² / AWG 20 – 16
Wire strip length	9.0mm (11/32in)
Maximum remote mounting distance of LED load	AWG 20 (0.52 mm ²) - 14 m / 46 ft AWG 19 (0.65 mm ²) - 18 m / 59 ft AWG 18 (0.82 mm ²) - 22 m / 72 ft AWG 17 (1.04 mm ²) - 28 m / 92 ft AWG 16 (1.31 mm ²) - 36 m / 118 ft

Automatic circuit breakers (MCB)

Maximum loading	MCB type	B10	B13	B16	C10	C13	C16
	Number of LED drivers	66	86	106	66	86	106

Standards and compliance

ENEC safety	EN 61347-1 EN 61347-2-13 (Emergency lighting)
ENEC performance	EN 62384
Conducted emissions	EN 55015
Radiated emissions	EN 55015
Radio disturbance characteristics	EN 55022
Harmonic current emissions	EN 61000-3-2
Electrostatic discharge	EN 61000-4-2
RFE field susceptibility	EN 61000-4-3
Electrical fast transient	EN 61000-4-4
Conducted radio frequency	EN 61000-4-6
Voltage dips	EN 61000-4-11
Electromagnetic immunity	EN 61547
ECodesign 2019/2020: Controlgear + luminaire	Flicker for LED: Pst LM ≤ 1.0 at full-load Stroboscopic effect for LED: SVM ≤ 0.4 at full load
DALI-2	IEC 62386-101 Edition 2.0, IEC 62386-102 Edition 2.0, IEC 62386-207 Edition 1
Surge protection	IEC 61000-4-5 level 3: 2kV DM, 2kV CM @ 2 Ohm
Surge protection	ANSI 62.41 1991 category B1: 2.5kV DM, 2.5kV CM @ 30 Ohm DALI input: 0.5 kV DM, 1 kV CM surge
RCM	AS/NZS 61347.1, AS/NZS 61347.2.13
Restriction of hazardous substances	RoHS3 (Directives 2011/65/EU-2015/863/EU)
SVHC-list substances	REACH Art.33

Certifications



Safety



FELV control terminals marked “Risk of electric shock” are not safe to touch. Dimming connected to FELV control terminal shall be insulated for Low Voltage supply of the control gear. Any terminals connected to the FELV circuit shall be protected against accidental contact.



Risk of electrical shock. May result in serious injury or death. Disconnect power before servicing or installing.



The LED driver may only be connected and installed by a qualified electrician. All applicable regulations, legislation, and building codes must be observed. Incorrect installation of the LED driver can cause irreparable damage to the LED driver and the connected LEDs.

Pay attention when connecting the LEDs: polarity reversal results in no light output and often damages the LEDs.



LED drivers are designed and intended to operate LED loads only. Powering non-LED loads may push the LED driver outside its specified design limits and is, therefore, not covered by any warranty.



eldoLED products are designed to meet the performance specifications as outlined at certain operating conditions in the data sheet. It is the responsibility of the fixture manufacturer to test and validate the design and operation of the system under expected and potential use cases, including faults.



Please observe voltage drop over long cable lengths. Longer cable lengths increase EMI susceptibility.



Product renderings and dimensional drawings are generic for the housing type. Product label, connector type and quantity may vary.

Europe, Rest of World

eldoLED B.V.
Science Park Eindhoven 5125
5692 ED Son
The Netherlands

E: info@eldoled.com
W: www.eldoled.com

North America

eldoLED America
One Lithonia Way
Conyers, GA 30012
USA

E: info@eldoled.com
W: www.eldoled.com
