

Pico Wireless Control and Mounting Accessories (for regions other than North, Central, and South America)

The Pico wireless control is a flexible and easy to use device that allows the user to control Lutron wireless load control devices from anywhere in the space. This battery operated control requires no external wiring.

Features

- Utilizes Lutron reliable Clear Connect RF technology.
- Indicator LED flashes to indicate a button press or when unit is in programming mode.
- Easy reconfiguration for use as:
 - Handheld remote
 - Wall mount control (with or without faceplate; faceplate adapter kit sold separately)
 - A table top control (table top pedestal sold separately).
- Battery powered Pico wireless control requires no wiring.
- 10 year battery life (one CR2032 battery included).¹
- Control available in a variety of button marking options.
- Can provide control of blinds, curtains, or lighting devices within a range of 9 m through walls and 18 m line-of-sight.
- Provides control for the following (depending on model number):
 - Vive² systems, including:
 - PowPak relay module
 - PowPak CCO module
 - PowPak 0–10 V_{DC} module
 - EcoSystem module not available
 - Energi Savr Node systems programmed with handheld App, through the use of a QS sensor module (QSM)
 - PowPak modules
 - GRAFIK Eye QS wireless systems
 - Rania wireless controls
 - HomeWorks QS wireless systems
 - GRAFIK RA 2 systems
 - Serena RF remote control shades
 - Sivoia QS wireless systems
 - Quantum systems³, through the use of a QS sensor module (QSM)
 - myRoom prime and plus systems

NOTE: Not all systems are available in all regions.

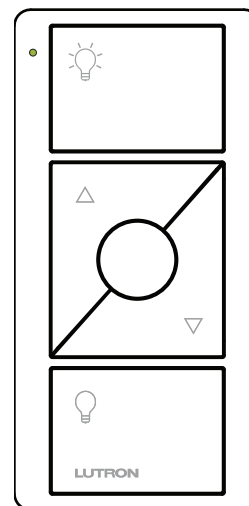

Pico wireless control⁴
(3BRL model shown)

¹ Based on a 1 year shelf life, an average of 10 button presses per day, and an ambient temperature of 30 °C (86 °F). Actual life may vary based on usage and environmental conditions.

² Available in version 01.07.xx or higher.

³ Available in version 3.4 or higher.

⁴ Lights zone control printing shown. Shade control printing is also available.

Job Name:	Model Numbers:
Job Number:	

Specifications

Regulatory Approvals

- Lutron Quality Systems registered to ISO 9001:2015.
- PK2 (Europe)
 - CE Marked
 - TRA Certified
- PN2 (India)
 - WPC Certified
- PM2 (China)
 - imDA Certified
- PQ2 (Hong Kong)
 - RCM Compliant
- RoHS Compliant

Power

- Operating voltage 3 V \equiv
- One (1) CR2032 battery (included)

System Communication and Capacity

- Pico wireless controls communicate using Radio Frequency (RF). See “Frequency/Channel Codes” in the **Model Number** section for more information.
- Unique system addresses prevent interference between systems.
- Pico wireless controls can be assigned to control shades or lighting devices that are within a range of 9 m through walls and 18 m line-of-sight.

Mounting Considerations

- All RF devices should be mounted on non-metallic surfaces to ensure proper performance.
- If you wish to mount your Pico wireless control to a metallic surface, the PICO-MOUNT-1-XX-CPN6774 will be required in order to maintain proper RF performance. For availability, please contact your local Lutron sales office.

Environment

- Ambient operating temperature: 0 °C to 60 °C
- Maximum 90%, non-condensing relative humidity
- Indoor use only

Warranty

- 1 Year Limited Warranty
For additional Warranty information, visit www.lutron.com/TechnicalDocumentLibrary/369-119_Wallbox_Warranty.pdf

Job Name: Job Number:	Model Numbers:
------------------------------	----------------

Pico Wireless Control Dimensions

Measurements shown as: mm

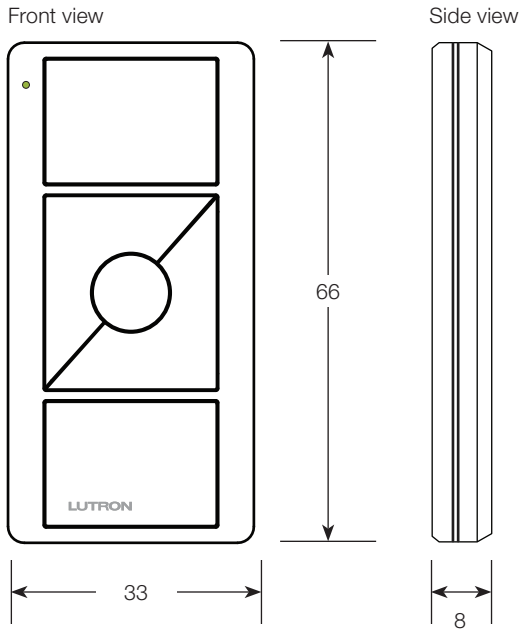

Job Name: Job Number:	Model Numbers:
------------------------------	----------------

Operation

2 Button Controls (2B)

Lights Models: L01

Screens Model: S08

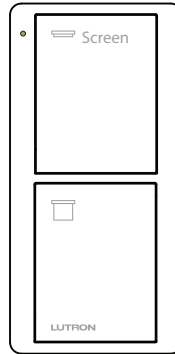
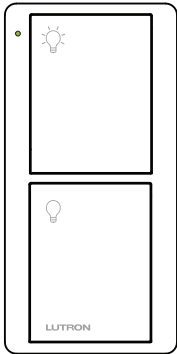

2 Button Controls with Raise/Lower (2BRL)

Lights Model: L01

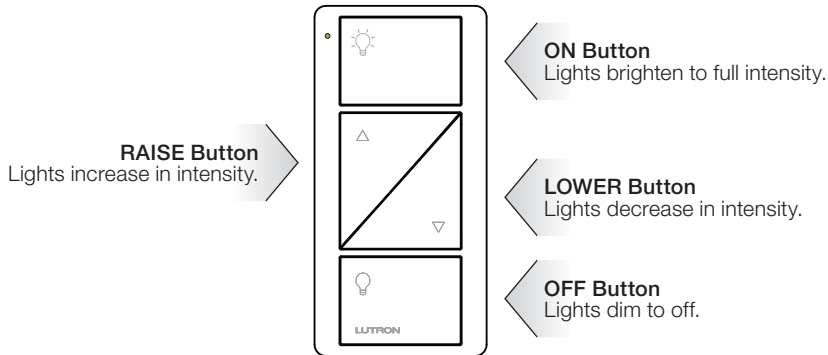

(continued on next page...)

Job Name:	Model Numbers:
Job Number:	

Operation (continued)

3 Button Controls (3B)

Lights Model: L01

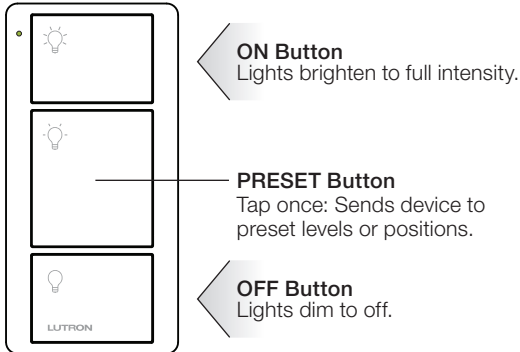

3 Button Controls with Raise/Lower (3BRL)

Lights Models: L01

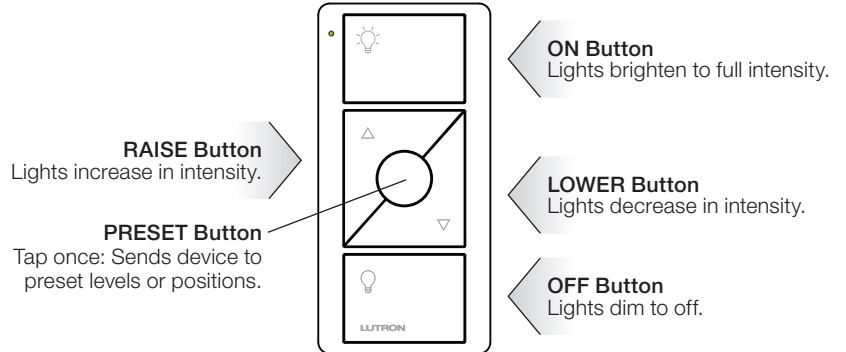

Shades Models: S01, S02, S03, S04, S06, S07

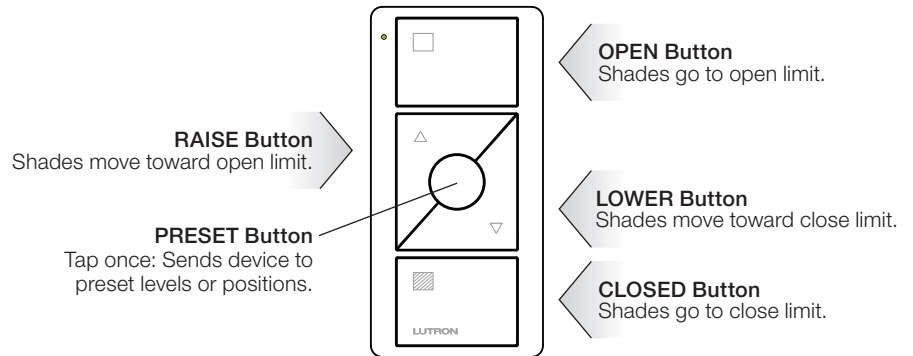

(continued on next page...)

Job Name:	Model Numbers:
Job Number:	

Operation (continued)

3 Button Controls with Raise/Lower (3BRL)

Venetian Blinds/Wood Blinds Model: S05

Audio Model: A01

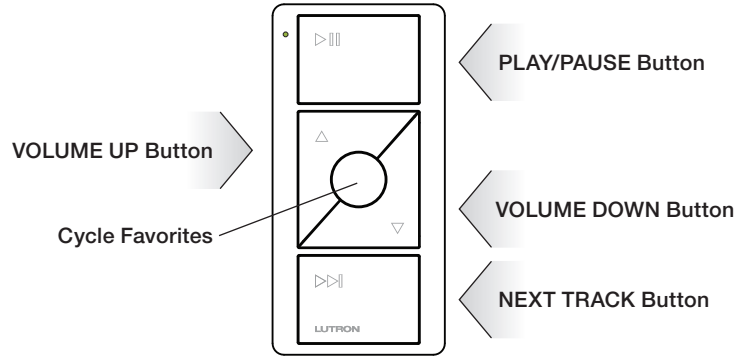
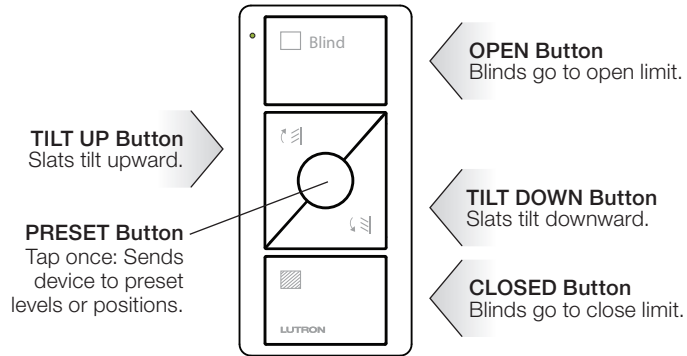

Horizontal Sheer Blinds Model: S09

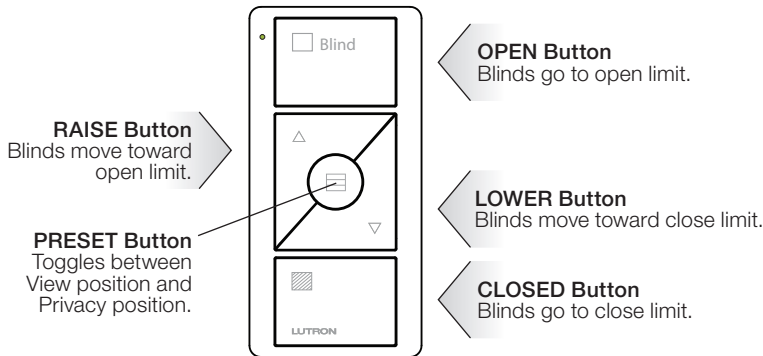

<p>Job Name:</p> <p>Job Number:</p>	<p>Model Numbers:</p>
--	------------------------------

Pico Wireless Control Model Number

For order quantities of 96 pieces or greater of the same model number, bulk packaging may be available. Mounting hardware is not available with bulk packaging. Contact your local Lutron sales office.

PX2 – XXXX – TXX – XXX

Frequency/Channel Codes*

Code	Frequency Range	Geographic Region
K	868.0 – 869.8 MHz	Europe, U.A.E.
M	868.0 – 868.5 MHz	China, Singapore
N	865.5 – 866.5 MHz	India
Q	433.0 – 434.7 MHz	Hong Kong, Macau

* Contact Lutron for frequency band compatibility for your geographic region. All wireless devices need to be the same frequency band for proper operation.

Button Marking Codes
(next page)

Button Configuration Codes

Code	Button Configuration
2B	2 Button
2BRL	2 Button with Raise/Lower
3B	3 Button
3BRL	3 Button with Raise/Lower

Color Codes

Textured Color	Code
Arctic White	AW
Black	BL

(continued on next page...)

Job Name:	Model Numbers:
Job Number:	

Pico Wireless Control Model Number (continued)



Button Marking Codes

2 Button

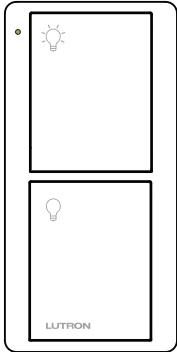

L01: Lights
(icons only)

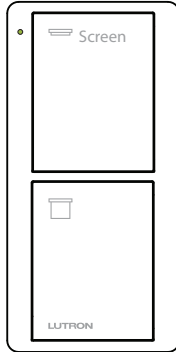

S08: Screens
(icons + text)

2 Button with Raise/Lower

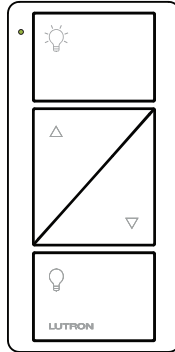

L01: Lights
(icons only)

3 Button

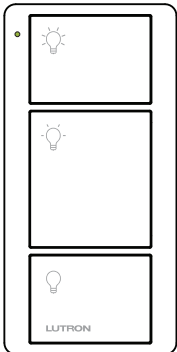

L01: Lights
(icons only)

3 Button with Raise/Lower

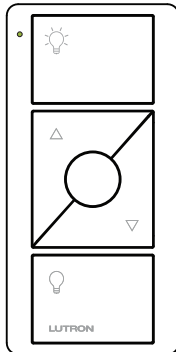

L01: Lights
(icons only)

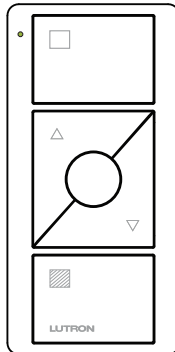

S01: Shades
(icons only)

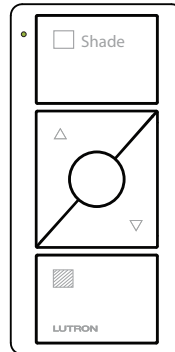

S02: Shades
(icons + text)

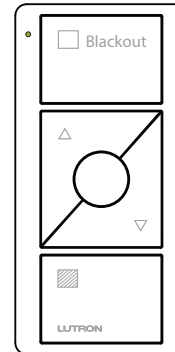

S03: Blackouts
(icons + text)

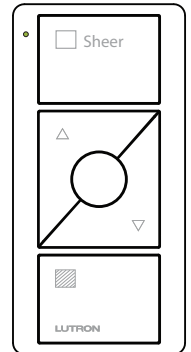

S04: Sheers
(icons + text)

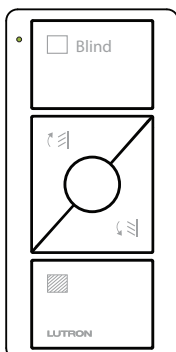

S05: Blinds
(icons + text)

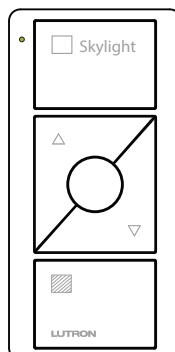

S06: Skylights
(icons + text)

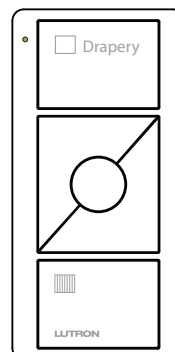

S07: Draperies
(icons + text)

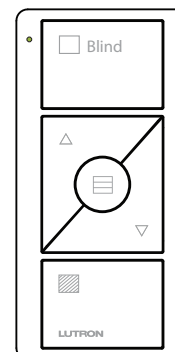

S09: Horizontal
Sheer Blinds
(icons + text)

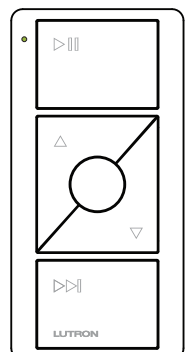

A01: Audio
(icons only)

Job Name:	Model Numbers:
Job Number:	

Pico Pedestal Model Number

Pedestals sold separately.

L – PEDX – XX

Capacity Codes

Capacity	Code
Single	1
Double	2

Color Codes

Color*	Code
White	WH
Black	BL

* Available in gloss finish only.

Pico Pedestal Dimensions

Measurements shown as: mm

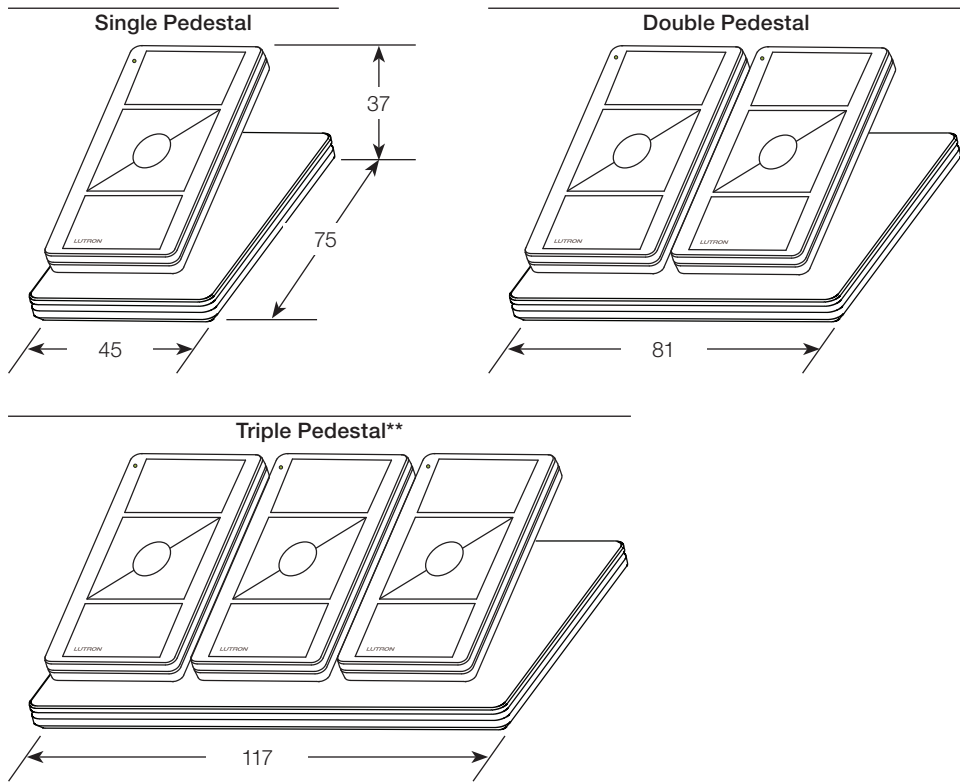

** For Triple Pedestals, contact your local Lutron sales office or visit us at www.lutron.com

Job Name:	Model Numbers:
Job Number:	

Mounting Options

Standalone Mounting

Adhesive Mounting

Included with Pico wireless control

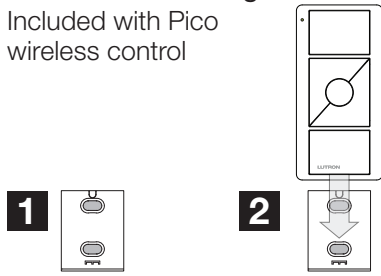

Screw Mounting

Model: PICO-SM-KIT (sold separately)

Kit includes special screws to be used for more permanent mounting and/or for non-smooth surfaces.

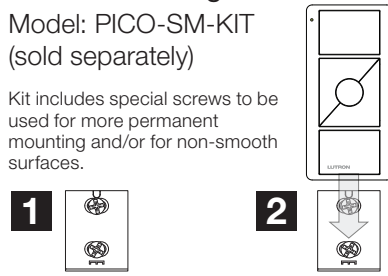

Metal Surface Mounting

Model: PICO-MOUNT-1-XX-CPN6774 (sold separately)

Contact your local Lutron sales office.

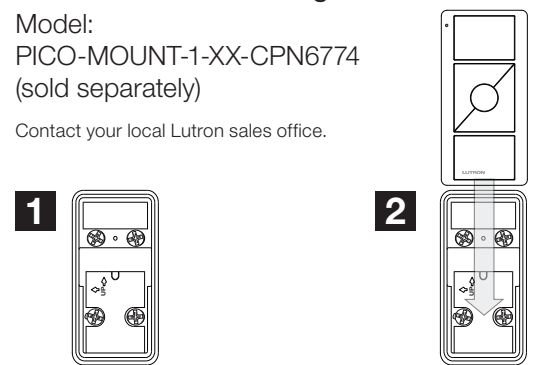

Wallbox Mounting or Surface Mounting

Square Faceplate Kits^{1,2}

Model: LPFP-S1-XXX (Plastic/Metal); LFGP-S1-CWH (Glass) (sold separately)

Faceplate adapter/faceplate included.

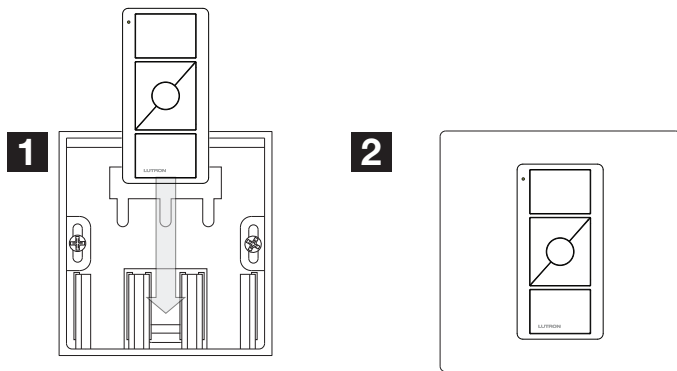

Model: LPFP-S2-XXX (Plastic/Metal); LFGP-S2-CWH (Glass) (sold separately)

Faceplate adapter/faceplate included.

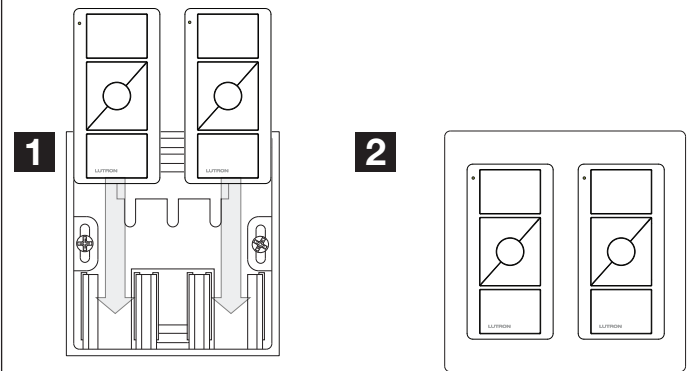

¹ For square or round wallboxes.

² For more information please see Lutron P/N 369884.

Car Visor Mounting

Model PICO-CARVISOR-CL (sold separately)

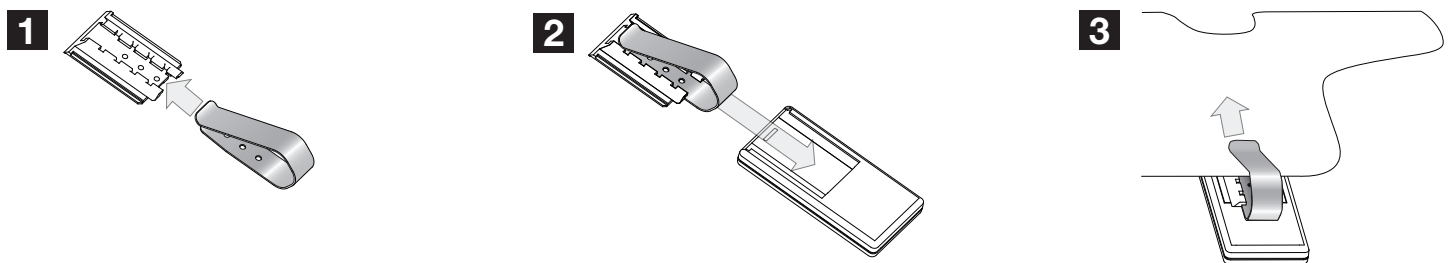

Lutron, Lutron, Pico, Maestro Wireless, PowPak, Sivoia, Quantum, GRAFIK Eye, RadioRA, HomeWorks, Rania, myRoom, GRAFIK RA 2, Energi Savr Node are trademarks or registered trademarks of Lutron Electronics Co., Inc. in the US and/or other countries.

Job Name:	Model Numbers:
Job Number:	