



Light
is our passion

50W DALI-2 'Dim to Dark' LED Driver

DUALdrive

DUALdrive is perfect for dynamic white lighting applications or for luminaires that combine task and ambient lighting. DUALdrive excels in configurability and low dimming - giving you every shade of white! Symbiosis ensures the LED driver works seamlessly together with LED modules, controls and intelligent luminaire elements.

Product offering



DUALdrive 560/A

Part number P/N	DL0560A3
Product description	DUALdrive, 50W, DALI-2, 2 control channels, constant current, 2x 55V output, square metal/plastic, side feed

Features & benefits

Natural dimming	Dim to dark, smooth brightness changes, excellent flicker performance, adaptable dimming curves, configurable minimum dimming level
LightShape	Tunable White: colour temperature and intensity control
LEDcode	LEDcode2 connects to integrated digital accessories, supports location-based IoT applications and enables wired and wireless lighting control through LEDcode peripheral devices
Programmable	Fine-tune your driver for any application
Performance	Universal input voltage range, low inrush current and total harmonic distortion (THD), high power factor and efficiency
Camera compatibility	Hybrid HydraDrive technology is proven to work in TV studios and security camera environments

Programming tools

Programming interface	TOOLbox pro (TLU20504)
Programming cable set	TOOLbox pro to LED driver, programming cable, 5pcs (TLC03051)
Programming Hand-held, Touch-and-Go	PJ0035HH1
Programming jig	PJ0500S1
Programming software	FluxTool

Warranty

Warranty period	General Terms and Conditions
-----------------	--

Order number configurator

Standard

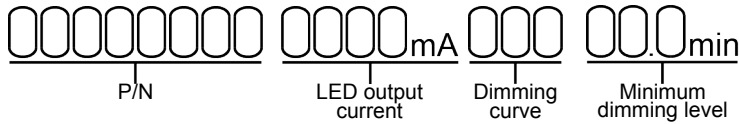

LightShape

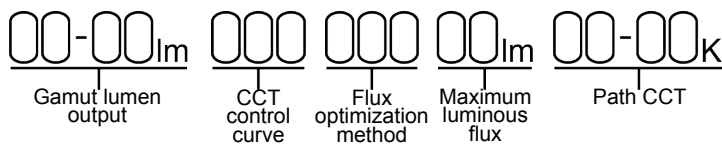
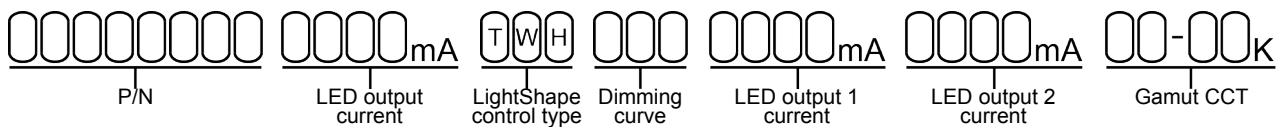

P/N	LED driver part number
LED output current, Standard	Enter value in 1mA increments, e.g. "811" for 811mA
LED output current, LightShape	Output current identical for all outputs? Enter value in 1mA increments, e.g. "811" for 811mA and leave the fields "LED output 1" and "LED output 2" blank. Output current different per output? Enter "MCUR" in LED output current and specify the differing currents in LED output 1/2.
LightShape control type	"TWH" stands for Tunable White
Dimming curve	"LOG" for logarithmic (default) "LIN" for linear
Minimum dimming level	Leave blank for default minimum dimming level of 0.1%. Specify in 0.1% increments, e.g. "10.5" for 10.5%.
Gamut CCT	LightShape-specific option. Enter the LEDs' CCT as "XX-YY" where XX is LED output 1 and YY is LED output 2. Available options per output: 18, 20, 22, 25, 27, 30, 35, 40, 50, 57 and 65. E.g. "18-50" for 1800K on LED output 1 and 5000K on LED output 2.
Gamut lumen output	Enter the lumen output range for LED output 1 and 2 as "XX-YY" where XX is LED output 1 and YY is LED output 2. Available range per output: from "01" for 100lm to "99" for 9900lm. E.g. "10-12" for 1000lm on LED output 1 and 1200lm on LED output 2.
CCT control curve	Enter the required CCT control curve: "LOG" for logarithmic, "LIN" for linear

Flux optimization method	Leave blank if a consistent luminous flux output over the full CCT range is required (default); enter "MAX" if the luminous flux must be limited to a maximum value for all outputs combined.
Maximum luminous flux	If Flux optimization method is set to "MAX", specify the required lumen output, e.g. "12" for 1200lm. If left blank it is constant (default).
Path CCT	Leave blank if Path CCT requires the same values as Gamut CCT. Or specify the Path CCT values as "XXYY" where XX is LED output 1 and YY is LED output 2. Available options per output: 18, 20, 22, 25, 27, 30, 35, 40, 50, 57, 65. E.g. "18-50" for 1800K on LED output 1 and 5000K on LED output 2.

Input characteristics

Nominal input voltage range AC	120 - 250V (ENEC), 120 - 277V (UL)
Absolute input voltage range AC	120 - 277V
Nominal input voltage range DC	120 - 250V
Maximum input current AC	0.65A @ 120V 0.36A @ 230V 0.3A @ 277V
Input frequency range	50 - 60Hz
Efficiency at full load	87%
Power factor at full load	> 0.9
THD at full load	< 20%
Maximum inrush current AC	< 200mA ² s @ 120V < 200mA ² s @ 230V < 200mA ² s @ 277V
Surge protection	2kV differential mode (DM) 2kV common mode (CM)
Maximum standby power	< 0.5W

Output characteristics

Maximum LED output power 50W

Number of LED outputs 2
(UL Class 2)

Programmable LED output current range 150 - 1400mA

LED output type Programmable in 1mA increments within specified current range

LED output current tolerance +/- 5% at programmed LED output current

LED output voltage range 1.5 - 55V

Operating window

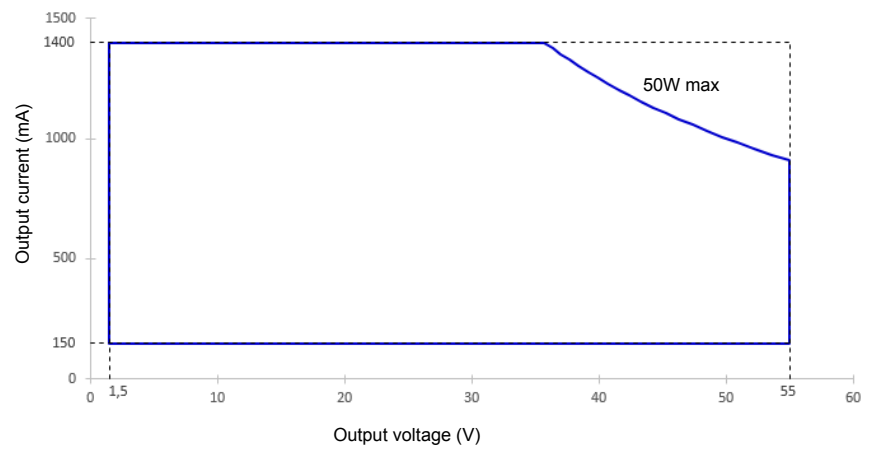

Control characteristics

Control channels	2
Control protocol	DALI-2 Device Type 6 LEDcode2
Dimming range	100% - 0.1%
Dimming curve options	Logarithmic (default) Linear
LightShape	Tunable White, 2x pc-white
Dimming method	Hybrid HydraDrive
Time delay to standby	< 30s

Dimming curves

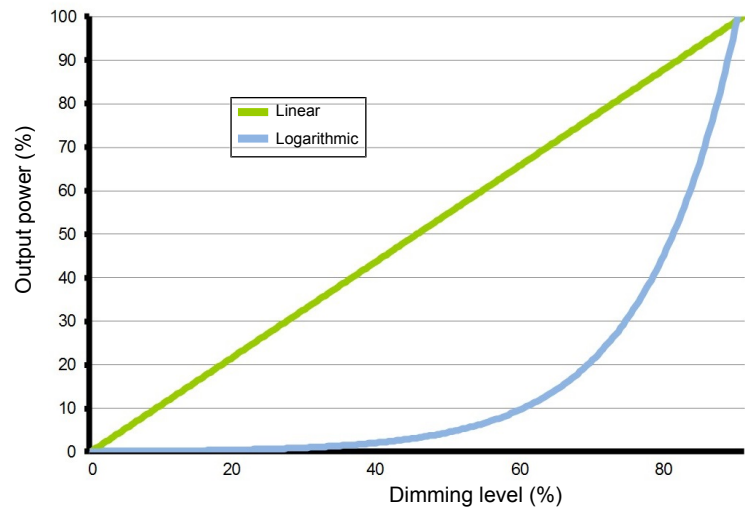

Performance

Typical efficiency vs load

Tested with a load on each LED output of 16 LEDs in series, programmed for 1000mA and at 25 °C ambient temperature. The measurements below 50W were performed by dimming the light output.

When LightShape is enabled: changing the CCT value has limited impact on the test data.

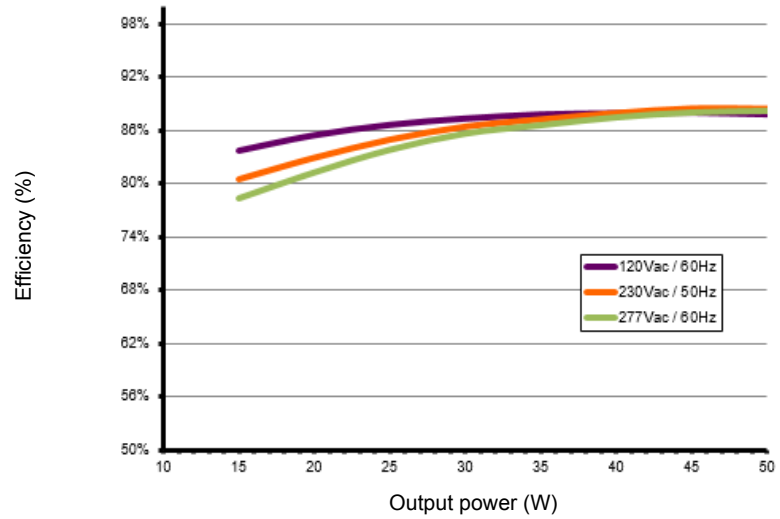

Typical power factor vs load

Tested with a load on each LED output of 16 LEDs in series, programmed for 1000mA and at 25 °C ambient temperature. The measurements below 50W were performed by dimming the light output.

When LightShape is enabled: changing the CCT value has limited impact on the test data.

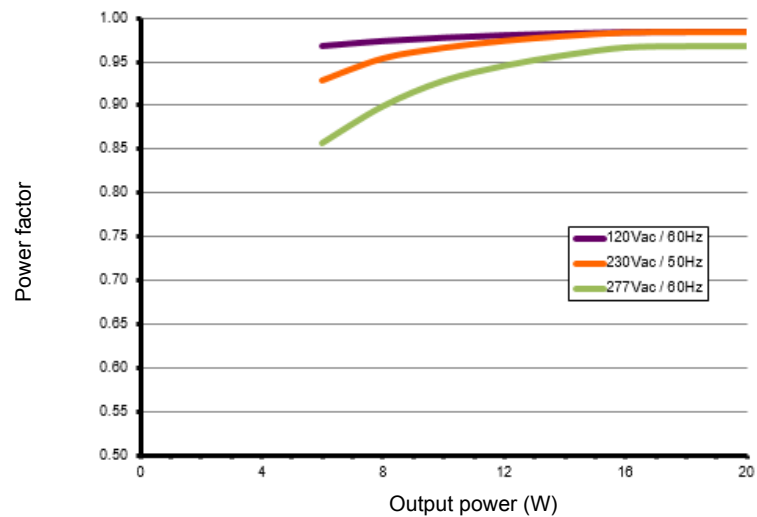

Typical THD vs load

Tested with a load on each LED output of 16 LEDs in series, programmed for 1000mA and at 25 °C ambient temperature. The measurements below 50W were performed by dimming the light output.

When LightShape is enabled: changing the CCT value has limited impact on the test data.

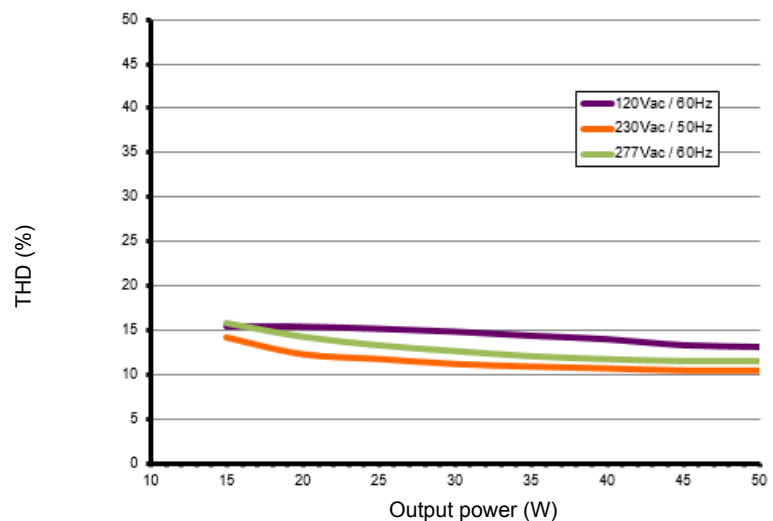

Typical flicker performance

Typical flicker percent as a function of frequency, measured across the dimming range. The results are overlaid with the low-risk (yellow) and no observable effect (green) levels as defined in IEEE P1789.

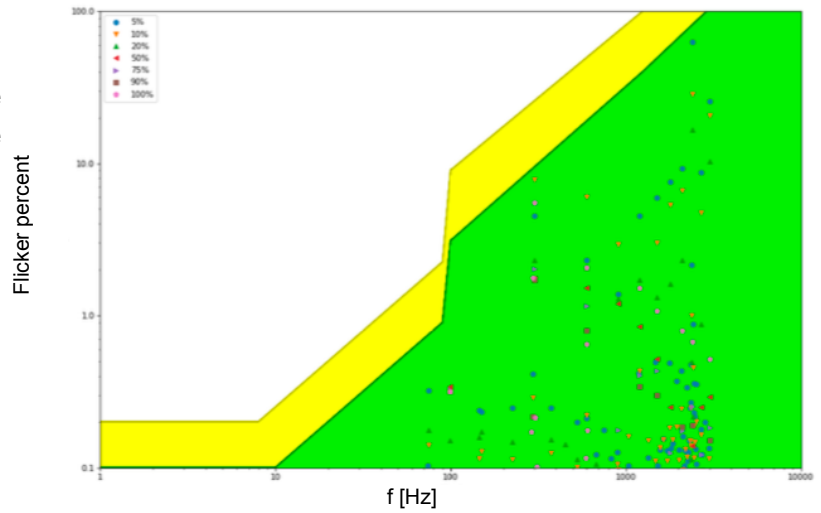

Environmental conditions

Operating ambient temperature (Ta) range -20 °C to +50 °C

Maximum operating case temperature (Tc max) 83 °C

Lifetime 50,000 hours at a maximum case temperature (Tc) of 76 °C

UL Type TL Measured Tref: 63 °C
Maximum allowed Tref: 80 °C
Measured at 1400 mA

TC point location



LED driver protection

Thermal	The LED output current is decreased whenever the internal LED driver temperature exceeds factory preset temperature. The LED output current is increased again once the internal LED driver temperature drops below this internal temperature threshold. If the internal LED driver temperature continues to increase, despite a decrease in output current, the LED driver will shut down.
LED output short circuit	The LED output current is cut off whenever the LED driver detects a short-circuit. The LED driver will attempt a restart every 400ms after a short-circuit is detected.
LED output overload	The LED driver decreases the LED output current sequentially, until it reaches its maximum rated power, whenever a load that exceeds the LED driver's maximum rated power is connected to the LED output.
Reverse polarity	The LED driver will not yield any current if the polarity of the load on the LED output is reversed. This situation will not damage the LED driver but may damage the LED load.

LED protection

Thermal protection LED	An external NTC thermistor, which is placed on a PCB near the LEDs, can be connected to the driver via the LEDcode/NTC terminals. The output current to the LEDs is then decreased by 75% whenever the NTC exceeds a maximum allowable temperature, which is specified by the user in the FluxTool software. The default NTC temperature limit is set to 70 °C.
Thermistor value	47kΩ
Suitable thermistors	Leaded: Vishay, P/N 238164063473 Screw: Vishay, P/N NTCASCWE3473J

LED driver mechanical details

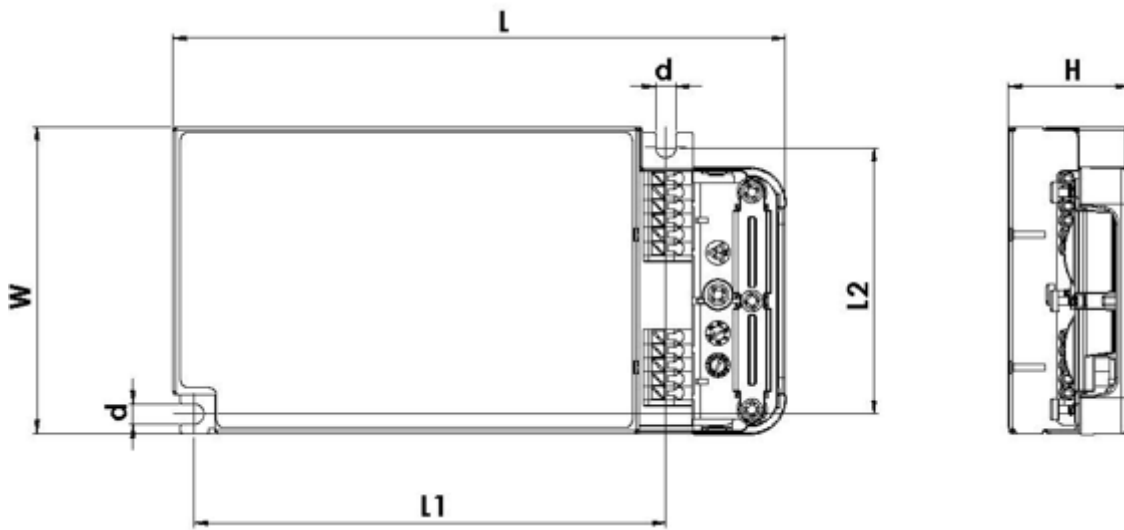

Length (L)	typical: 153.1 mm / 6.03 in maximum: 153.6 mm / 6.05 in
------------	--

Width (W)	typical: 76.2 mm / 3.00 in maximum: 76.7 mm / 3.02 in
-----------	--

Height (H)	typical: 30.1 mm / 1.19 in maximum: 30.6 mm / 1.20 in
------------	--

Mounting hole diameter (d)	typical: 5.0 mm / 0.20 in maximum: 5.2 mm / 0.20 in
----------------------------	--

Center to center mounting hole distance (L1)	typical: 118 mm / 4.65 in maximum: 118.5 mm / 4.67 in
--	--

Center to center mounting hole distance (L2)	66.2 mm / 2.61 in tolerance: +/- 0.5 mm / 0.02 in
--	--

3D files available on product web page	IGS STEP
--	-------------

Weight	295 g
--------	-------

Mounting torque	Not to exceed 0.5Nm
-----------------	---------------------

Packaging

Length x Width x Height	490 x 380 x 190 mm / 19.3 x 15 x 7.5 in
Weight (including products)	13.1 kg
Products per box	40 pcs

Connector layout

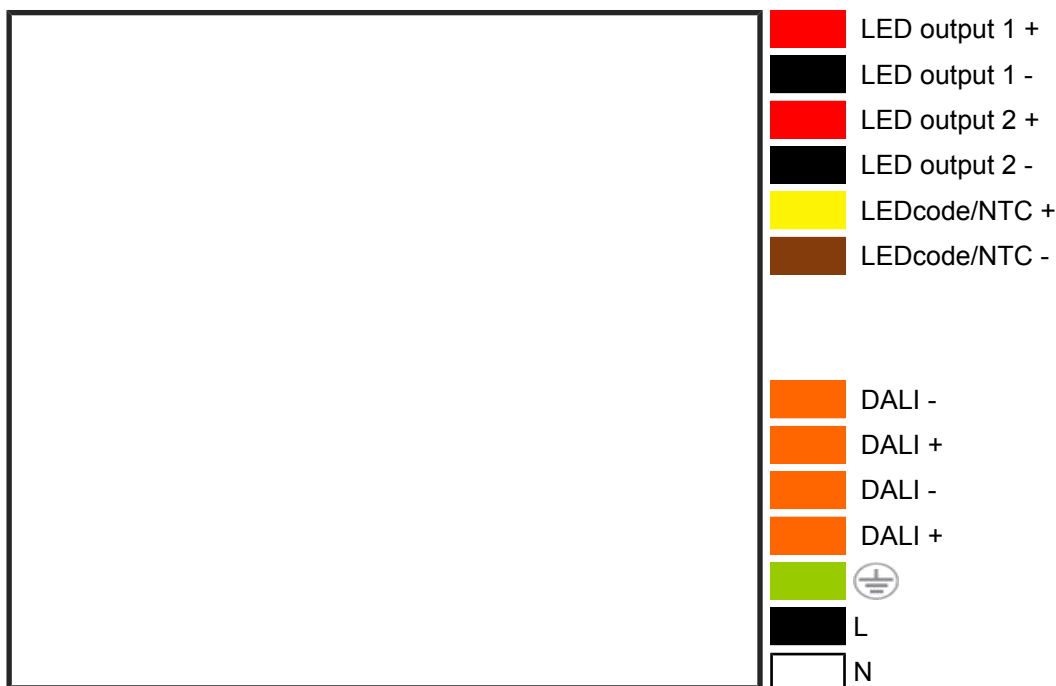

Input wiring specifications

Connector type	push-in terminals
Connector supplier and series	Wago 250 series
Wire type	solid or stranded copper
Wire core cross section	0.5 - 1.5mm ² / AWG 20 – 16
Wire strip length	9.0mm / 11/32"

Output wiring specifications

Connector type	push-in terminals
Connector supplier and series	Wago 250 series
Wire type	solid or stranded copper
Wire core cross section	0.5 - 1.5mm ² / AWG 20 – 16
Wire strip length	9.0mm / 11/32"
Maximum remote mounting distance of LED load	For independent use: 2 m / 6.5 ft For in-fixture use: AWG 20 (0.52 mm ²) - 14 m / 46 ft AWG 19 (0.65 mm ²) - 18 m / 59 ft AWG 18 (0.82 mm ²) - 22 m / 72 ft AWG 17 (1.04 mm ²) - 28 m / 92 ft AWG 16 (1.31 mm ²) - 36 m / 118 ft

Automatic circuit breakers (MCB)

Maximum loading	MCB type	B10	B13	B16	C10	C13	C16
	Number of LED drivers	14	18	22	14	18	22

Standards and compliance

UL, recognized component	UL 1310 UL 8750 (Class 2 output). Type TL LED driver.
ENEC safety	EN 61347-1 EN 61347-2-13 (Emergency lighting)
ENEC performance	EN 62384
Conducted emissions	EN 55015, Class B
Radiated emissions	EN 55015, Class B
Radio disturbance characteristics	EN 55022
Harmonic current emissions	EN 61000-3-2
Electromagnetic immunity	EN 61547
DALI-2	IEC 62386-101 Edition 2.0, IEC 62386-102 Edition 2.0, IEC 62386-207 Edition 1
Surge protection	IEC 61000-4-5 level 3: 2kV DM, 2kV CM @ 2 Ohm
Surge protection	ANSI 62.41 1991 category B1: 2.5kV DM, 2.5kV CM @ 30 Ohm DALI input: 0.5 kV DM, 1 kV CM surge
FCC	47 CFR Part 15 class B
RCM	AS/NZS 61347.1, AS/NZS 61347.2.13
Restriction of hazardous substances	RoHS3 (Directives 2011/65/EU-2015/863/EU)

Certifications



Safety



FELV control terminals marked “Risk of electric shock” are not safe to touch. Dimming connected to FELV control terminal shall be insulated for Low Voltage supply of the control gear. Any terminals connected to the FELV circuit shall be protected against accidental contact.



Risk of electrical shock. May result in serious injury or death. Disconnect power before servicing or installing.



The LED driver may only be connected and installed by a qualified electrician. All applicable regulations, legislation, and building codes must be observed. Incorrect installation of the LED driver can cause irreparable damage to the LED driver and the connected LEDs.

Pay attention when connecting the LEDs: polarity reversal results in no light output and often damages the LEDs.



LED drivers are designed and intended to operate LED loads only. Powering non-LED loads may push the LED driver outside its specified design limits and is, therefore, not covered by any warranty.



eldoLED products are designed to meet the performance specifications as outlined at certain operating conditions in the data sheet. It is the responsibility of the fixture manufacturer to test and validate the design and operation of the system under expected and potential use cases, including faults.



Please observe voltage drop over long cable lengths. Longer cable lengths increase EMI susceptibility.



Product renderings and dimensional drawings are generic for the housing type. Product label, connector type and quantity may vary.

Europe, Rest of World

eldoLED B.V.
Science Park Eindhoven 5125
5692 ED Son
The Netherlands

E: info@eldoled.com
W: www.eldoled.com

North America

eldoLED America
One Lithonia Way
Conyers, GA 30012
USA

E: info@eldoled.com
W: www.eldoled.com
