

USER'S AND INSTALLATION MANUAL

Galio Star Insert Automatic

Natural Gas / Propane

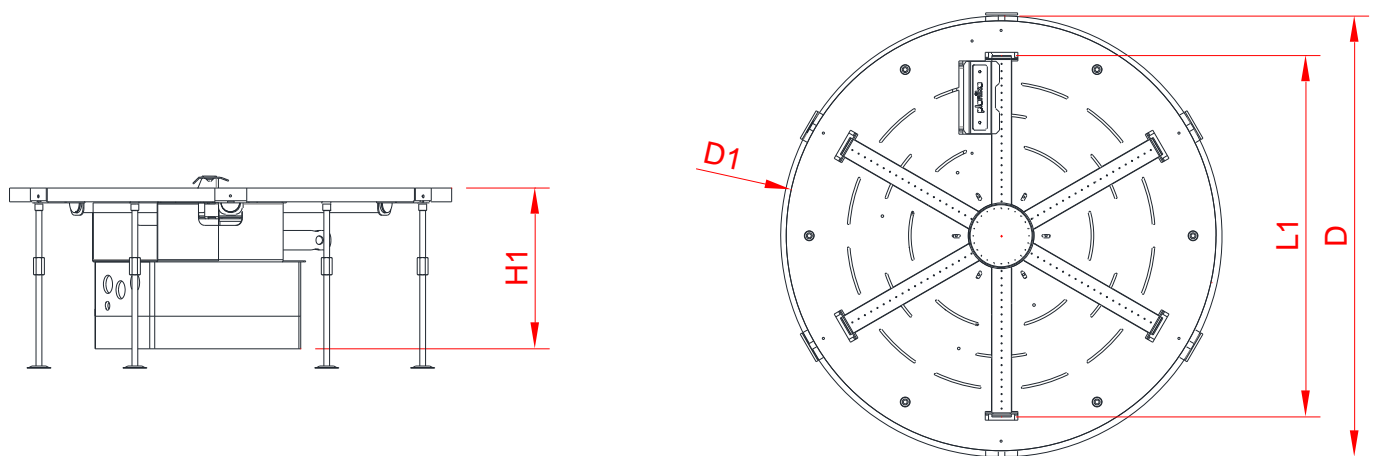
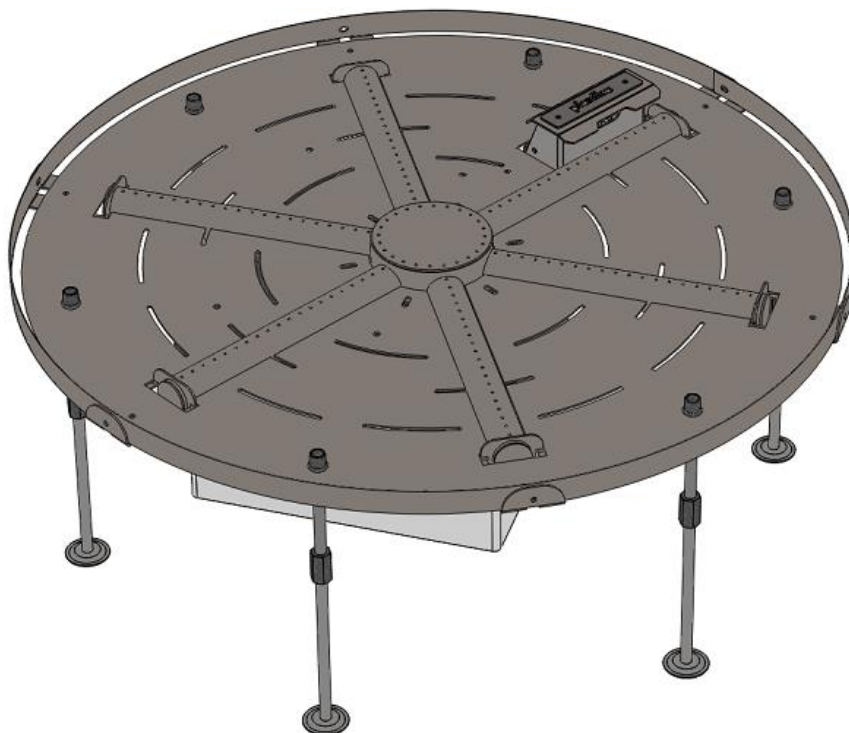

	H1	L1	D	D1
[mm]	222	499	615	595

IT IS OBLIGATORY TO READ AND KEEP THIS INSTRUCTION MANUAL.

TABLE OF CONTENTS

1.	INTRODUCTION.....	3
2.	SAFETY INSTRUCTION	5
2.1.	Safety instruction regarding the use of the gas cylinder	5
2.2.	Ventilation of cylinder compartments for cylinders exceeding 1.25 kg gas capacity	6
3.	INSTALLATION.....	7
3.1.	Box contents.....	7
3.2.	Unboxing and installation	7
4.	MONTAGE.....	8
4.1.	Directions of how to design a housing for the fireplace.....	9
4.2.	Installation of the gas linkage.....	10
4.2.1.	Natural gas connection.....	11
4.2.2.	Connection and replacement of the gas cylinder (LPG version).....	11
5.	OPERATING INSTRUCTIONS	12
5.1.	Setting up signal code	12
5.2.	Installing the control unit (Wall Switch)	13
5.3.	Installing the battery box	14
5.4.	Replacing the batteries	15
5.5.	Remote control	16
5.6.1.	Setting fahrenheit or celsius.....	16
5.6.2.	Setting the time	17
5.6.3.	Child proof.....	17
5.6.4.	Switch the Fire ON and OFF.....	17
5.6.5.	Stand-by mode (Pilot flame).....	18
5.6.6.	Flame height adjustment.....	18
5.6.7.	Flame height directly to minimum position	19
5.6.8.	Flame height directly to maximum position.....	19
5.6.9.	Countdown timer	19
5.6.10.	Automatic Turn Down To Pilot	19
5.6.11.	Automatic Shut Off.....	20
5.7.	Wall Switch.....	20
6.	TESTING	21
6.1.	Checking for gas leaks	21
6.2.	Checking the flame appearance	21
7.	MAINTENANCE AND UPKEEP	21
7.1.	Testing and cleaning.....	21
8.	TROUBLESHOOTING.....	22
9.	PRESSURE ADJUSTMENT	24
10.	ELECTRICAL DIAGRAMS.....	28
11.	TECHNICAL SPECIFICATION	29
12.	MANUFACTURER'S CONTACT DETAILS.....	30
13.	DISTRIBUTOR'SCONTACT DETAILS	30

1. INTRODUCTION

The Galio Star Insert Automatic fireplace is a decorative fuel-effect gas appliances intended only for outdoor use. It is obligatory to acquaint oneself with the below installation manual and user's manual before committing to the installation and use of the Galio Star Insert Automatic fireplace. This manual is to be kept safe for the lifetime of the device.

The Planika company designs and manufactures gas devices that meet the highest standards of quality, and safety. The device meets the essential Gas appliances General requirements of the AS/NZS 5263.0:2017 and AS/NZS 5601. Each gas fireplace produced by Planika is subjected to factory quality control, during which it undergoes rigorous safety tests. Materials of the highest quality used for its production guarantee the user a smooth and reliable functioning of the device.

The device is delivered together with the instruction manual and assembly instructions. The assembly instructions provide the necessary information to install the device in such a way that it works properly and safely. In addition, you can find technical data about the device, information on its maintenance and possible failures that may occur, along with their possible causes and how to resolve them.

WARNING! The installer must be a certified and qualified specialist in gas heating and electricity and should have all the qualifications required by local law.

CE Declaration of conformity

We hereby declare that both the design and construction of a gas heating device manufactured by **Planika Sp. z o.o. (with registered office at Bydgoska 38, 86-061 Brzoza, Poland)** meet the essential requirements contained in the Directive and the Ordinance on gas appliances.

Product: Gas device with decorative combustion effect for outdoor use

Type: Galio Insert, Galio Corten , Galio Fire Pit Insert , Galio Fire Pit Corten

Standards: AS/NZS 5263.0:2017, AS/NZS 5601

The notified body: the IAPMO R&T Oceana (7-11 Fullard Road, NARRE WARREN VIC. 3805 AUSTRALIA) carried out and on 14.11.2019 issued the certificate no. GMK10583 for the above mentioned devices.

The company's quality control system guarantees that the mass-produced devices meet the essential requirements of the applicable Directives and Regulations as well as the standards contained therein. This Declaration is annulled if any modifications are made to the device without the prior written consent of Planika.

Brzoza 14.11.2019

 **PREZES ZARZĄDU**
Jarosław Dąbrowski

Chairman of the Board

Jarosław Dąbrowski

INSTALLATION NOTICE

- The installation of this appliance is only to be carried out by an authorized person in accordance with the Manufacturers Instructions , local gas fitting regulations , AS/NZS5601.1 installation code for gas burning appliances and any other relevant statutory regulations.
- In all cases the installation of this appliance shall meet the requirements as set out in AS/NZS5601.1

IMPORTANT SAFETY NOTICES

- **DO NOT PLACE ARTICLES ON OR AGAINST THIS APPLIANCE.**
- **DO NOT USE OR STORE FLAMMABLE MATERIAL IN OR NEAR THE APPLIANCE.**
- **DO NOT SPRAY AEROSOLS IN THE VICINITY OF THIS APPLIANCE WHILST IT IS IN OPERATION.**
- **DO NOT MODIFY THIS APPLIANCE.**
- **DO NOT USE ANY ADAPTOR AT THE CYLINDER CONNECTION**
- **THIS APPLIANCE IS DESIGNED TO OPERATE WITH LUMINOUS FLAMES. THIS MAY EXHIBIT SLIGHT CARBON DEPOSITS. THIS IS A NORMAL CONDITION AND IS NOT COVERED BY WARRANTY**

WARNING

This fireplace has a naked flame, care should be taken when it is operating if children or the infirm are in close proximity. A safety screen is recommended if constant supervision is not possible. It is recommended that a secondary guard complying with AS-NZS2286 be installed.

The appliance is not intended for use by persons (including children) with reduced physical, sensory or mental capabilities, or lack of experience and knowledge, unless they have been given supervision or instruction concerning use of the appliance by a person responsible for their safety. Children should be supervised to ensure that they do not play with the appliance.

2. SAFETY INSTRUCTION

- **Read the instructions before use. Keep the instructions for future reference.**
- For use outdoors only. The use of this appliance in enclosed areas is DANGEROUS and is PROHIBITED
- The Galio Star Insert Automatic is not a free-standing device and must be housed.
- The installation of the appliance must take into account its trouble-free removal in case of service.
- Do not start up the device before it's placed safely into the prepared housing.
- The Galio Star Insert Automatic fireplace should be installed and serviced annually according to the below installation manual as well as enforced national and local laws regarding gas safety (installation and use).
- One needs to assess whether the data on the product plaque complies with the local type of gas and pressure.
- Do not change the structure of the device or its sealed elements nor modify the default settings of the Galio Star Insert Automatic fireplace.
- Do not set any additional imitation blocks nor any glowing coal fragments on the burner.
- A ventilation grid or slot with a ventilation area of 150cm² is required at the base of the housing. A device without the grid or slot for ventilation will function incorrectly causing a threat of damaging the unit or causing a fire.
- A CO₂ or a powder fire extinguisher needs to be placed near the device.
- During the first ignition the Galio Star Insert Automatic fireplace needs to be burnt on maximum level for a few hours in order for the elements to acquire correct temperature and for the remains of paint, lacquer and lubricant to evaporate.
- Do not move the burner during operation.
- The Galio Star Insert Automatic fireplace was designed for decorative purposes. The surface of the Galio Star Insert Automatic fireplace may get hot (up to 100 degrees Celsius). **WARNING!:** parts of the device that are easy to reach may be very hot. Keep children away from the appliance.
- Install the fireplace away from flammable materials.
- When the Galio Star Insert Automatic fireplace is on it's not to be exposed to rain.
- When not being used the Galio Star Insert Automatic is to be protected from atmospheric conditions and the main valve of the gas cylinder needs to be turned off.
- All parts of the Galio Star Insert Automatic fireplace are made of stain resistant material.
- Never leave a turned on Galio Star Insert Automatic without supervision.
- The Galio Star Insert Automatic fireplace needs to be installed in a place inaccessible for children, unauthorized persons or animals for the direct contact with the flame or hot parts of the device to be impossible.
- In case of heavy wind the Galio Star Insert Automatic fireplace needs to be immediately turned off and one needs to wait until the heavy wind passes.
- In case of noticing any sort of gas leaks the fireplace as well as the main valve of the gas cylinder need to be turned off.
- After use turn off the gas cylinder valve.

2.1. Safety instruction regarding the use of the gas cylinder

- Use only the type of gas and pressure specified by the manufacturer.
- The gas cylinders should always be placed in a vertical position – during use and transport.
- Always store the gas cylinder in an easily accessible place to allow its immediate turn-off.
- Change the gas cylinder in an amply ventilated area, away from any ignition source (candle, cigarettes, other flame producing appliances).
- Do not obstruct the ventilation holes of the cylinder housing.
- In the event of gas leakage, the appliance shall not be used or if alight, the gas supply shall be shut off and the appliance shall be investigated and rectified before it is used again.

- During the installation process do not allow an open flame or any ignited object to reach the gas cylinder.
- The gas cylinder must be located in accordance with AS/NZS 5601 and AS/NZS 1596.
- Leaks should be found with the use of a cleaning liquid and water. If bubbles form on the surface that means there's a leak that must be fixed before operation.
- Use only approved and certified hose and regulator assemblies, check condition before each use and replace every 2 years.
- Check the flexible hose at least once per month and each time the cylinder is changed. If it shows signs of cracking, splitting or other deterioration it shall be exchanged for new hose of the same length and of the equivalent AS/NZS 1869 Class as recommended by the place of purchase.
- Do not connect the gas cylinder directly to the appliance without regulator.
- The tubing or the flexible hose must be changed within the prescribed intervals.
- Use only the type of gas and the type of cylinder specified in these instructions
- Ensure any hoses are kept away from sharp edges and hot surfaces. Refrain from bends and twists over its full length.
- Remember that the LPG bottle should be stored in a well-ventilated place. LPG gas is heavier than air and its accumulation near the surface may generate an explosive mixture.
- The gas cylinder needs to be shut if the fireplace is not being used.
- Filling the gas cylinders is to be commissioned to certified gas filling stations.
- Replacement of empty bottles for full ones is to be conducted only in authorised locations.

2.2. Ventilation of cylinder compartments for cylinders exceeding 1.25 kg gas capacity

Cylinder compartments shall have permanent openings ventilating directly to the outside of the appliance and consisting of either of the following:

- Perforations, uniformly distributed over the height of the enclosure and with a total free area of not less than 25% of the sidewall area. Or
- Separate openings at high and low level, such that—
 - the total free area at high level is not less than 200 cm² and is within 125 mm of the top of the cylinder compartment; and
 - the total free area at low level is not less than 200 cm², and—
 - at least 25% of the required area is within 15 mm of the base of the cylinder compartment;
 - the total required area is within 125 mm of the base of the cylinder compartment; and
 - the openings cannot be obstructed by the cylinder(s).

A cylinder compartment shall be permanently separated from any ignition source within the appliance combustion area to prevent the ignition of escaping gas within the cylinder compartment

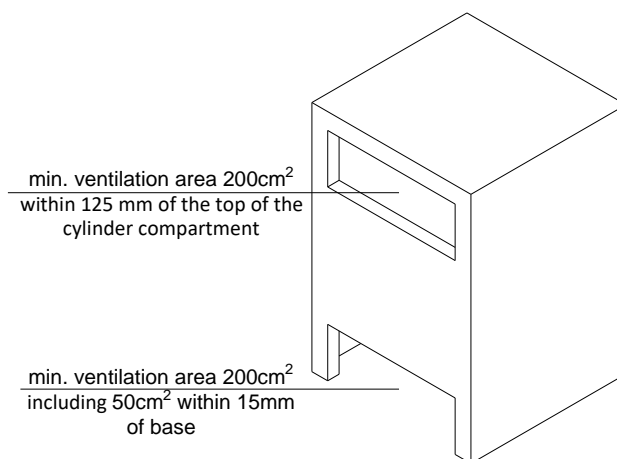

3. INSTALLATION

3.1. Box contents

- 1x complete gas fireplace
- 1x Wall Switch
- 1x Remote control with 2x AAA Batteries
- 4x AA Batteries
- 8x bag of decorative stones
- 1x AS/NZS 1869 hose assembly – installed (only LPG version)
- 1x pressure regulator– installed (only LPG version)
- 1x installation and user's manual

3.2. Unboxing and installation

- The contents of the boxes need to be carefully unwrapped from the foam foil.
- Remove the bags with decorative stones from the burner reservoir and place them away from it.
- Remove the Styrofoam placed on the unit.
- Check the completeness of the elements with the contents list.
- Make sure that the insert nor its elements weren't damaged during the transportation (if they were, notify the supplier).
- Install the Galio Star Insert Automatic fireplace in the prepared housing made according to the specification.
- The decorative stones are to be scattered evenly around the reservoir to completely cover the burner of the fireplace.

WARNING!!! The stones may not cover or be placed inside the device protecting the ignition unit.

- It is forbidden to place any other decorative stones which are not supplied by the manufacturer.
- Delivered stones (Silicon Carbide – SiC, content 85%-95%).

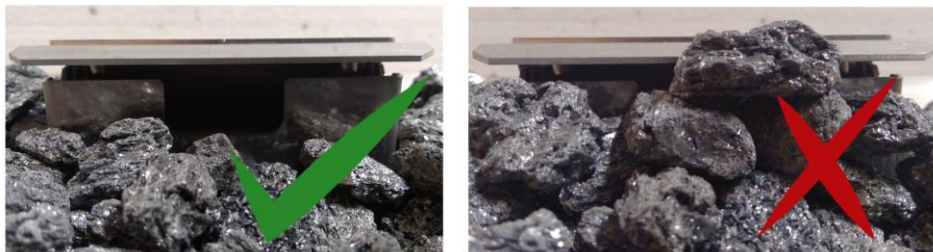

Photo 1

- In the case of Galio Star Insert Automatic powered with natural gas, to obtain the optimum image of the flame, cover the burner with a single layer of decorative stones leaving some spaces uncovered of approximately every 10 cm



Photo 2

- If all the points were completed according to the instruction the gas cylinder can be now connected.

4. MONTAGE

WARNING!!! All elements above the fireplace need to be made of non-flammable materials.

- Select a location where the outdoor fire can be supervised during operation.
- The outdoor fire is suitable for outdoor use only and must not be used indoors.
- An isolation switch must be fitted at the appliance or on an adjacent wall to allow for emergency shutdown and maintenance.
- Installation must meet Australian gas codes AS/NZS5601.
- Do not install under trees or overhanging branches.
- Do not install under eaves, overhang or ceilings.
- Ensure adequate space around the fire to enjoy the flame from a safe distance from the heat and flame.
- Appliance should be covered or protected in wet weather. Not suitable for use in wet or windy weather.

This appliance shall only be used in an above ground open air situation with natural ventilation, without stagnant areas, where gas leakage and products of combustion are rapidly dispersed by wind and natural convection.

Any enclosure in which the appliance is used shall comply with the following:

- An enclosure with walls on all sides, but at least one permanent opening at ground level and no overhead cover.
- Within a partial enclosure that includes an overhead cover and no more than two walls.
- Within a partial enclosure that includes an overhead cover and more than two walls the following shall apply.
 - at least 25% of the total wall area is completely open, and
 - at least 30% of the remaining wall area is open and unrestricted
- In the case of balconies, at least 20% of the total wall area shall be and remain open and unrestricted.
- This appliance shall not be used or installed indoors.
- The following figures are diagrammatical representations of outdoor areas

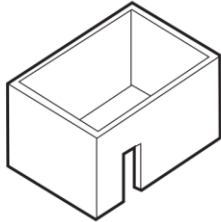

Example 1

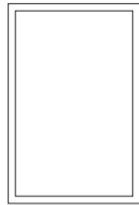

Example 2

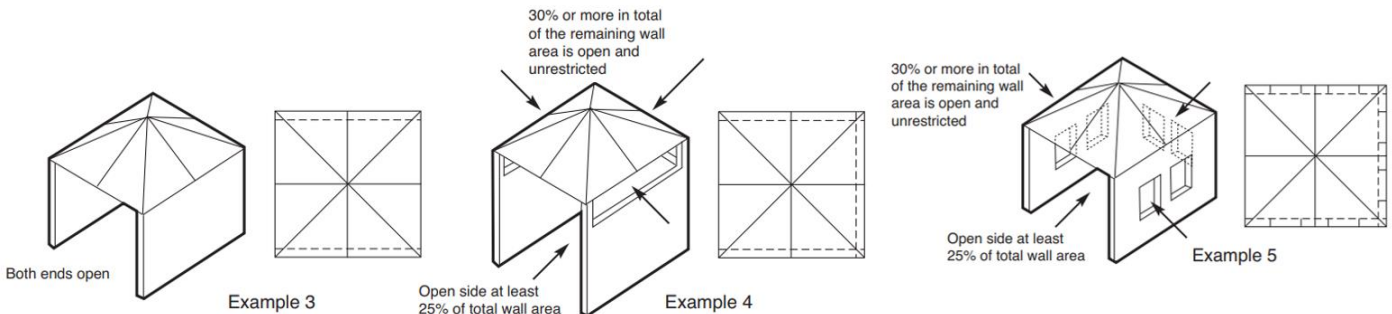
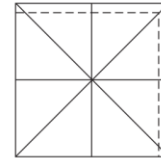
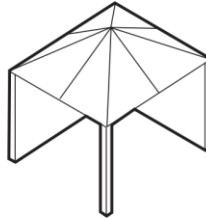

- In accordance with fire safety measures there should be no flammable objects in direct contact with the device nor within a 1 metre radius from the fire. Additionally, Planika doesn't recommend placing heat-sensitive objects above the fireplace as it may shorten their lifetime. Planika will not be responsible for any damage caused by high temperature affecting objects installed above the fire.

4.1. Directions of how to design a housing for the fireplace

- Enclosure must be stable and be constructed of non-combustible materials.
- Enclosure and fire must be installed above ground level and have adequate drainage.
- The burner cavity must have an opening of at least 150cm² for adequate combustion air
- Ventilation allows for residual heat and unburnt gases to escape the enclosure.

Gas fire pit minimum height must comply with:

- A gas fire pit with a burner less than 1m above the ground must be guarded to the full height of the flame such that a child aged between 2 and 6 years of age cannot gain access to the flame when assessed in accordance with IEC Guide 117.
- A guard incorporated into an appliance to comply with requirement 2 (above) must be an integral part of the appliance. Contact dealer for 300mm tall glass guards and clasps.

All necessary information concerning the touchable surfaces of the equipment, including the following, shall be gathered:

- Classification of surface temperatures as hot, moderate or cold
- Material and texture of the surface
- All normal operating conditions of the equipment including the setting that results in maximum temperatures of the touchable surfaces
- The probability of contact, taking into account the arm's reach of a person shown in below Figure and Table

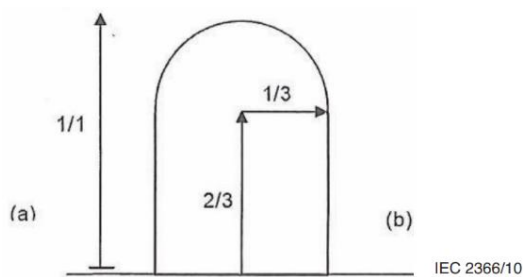

Figure - Arm's reach

The distance is interpreted as either a fully stretched person (a) or a person reaching for an item (b)

Age (Years)	Arm's reach in the vertical direction (see (a) of Figure measured from the floor (m))
Children from 2 years to less than 6 years	1,5

Minimum total high from the ground

- Use construction materials to build solid base for the fireplace (non-combustible are not required)
- Follow the requires provided below this section for the cavity dedicated for the burner
- Minimum size of the base is provided in below scheme

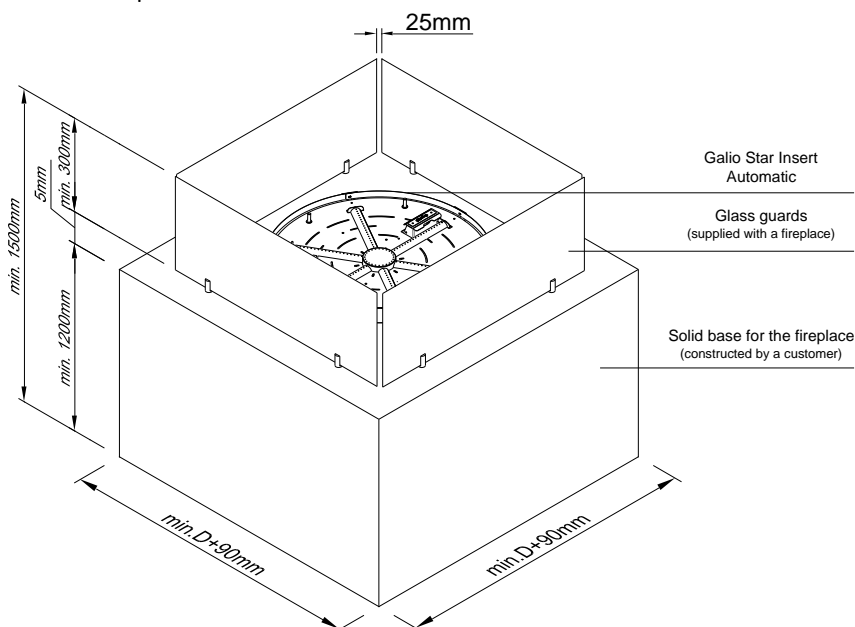



WARNING



Cavity has to be made with ventilation grate located on the lowest point as on below scheme. It is required for cooling the device and water drainage.

When preparing the cavity make sure the surface on which the insert is placed is well-levelled.

- The edges of the cavity in which the insert is to be placed need to be finished in an aesthetic way
- Bottom surface of the cavity has to be made with min. 5% inclination to lead out water through
- Provide gas connection and wallswitch connection in protective conduit

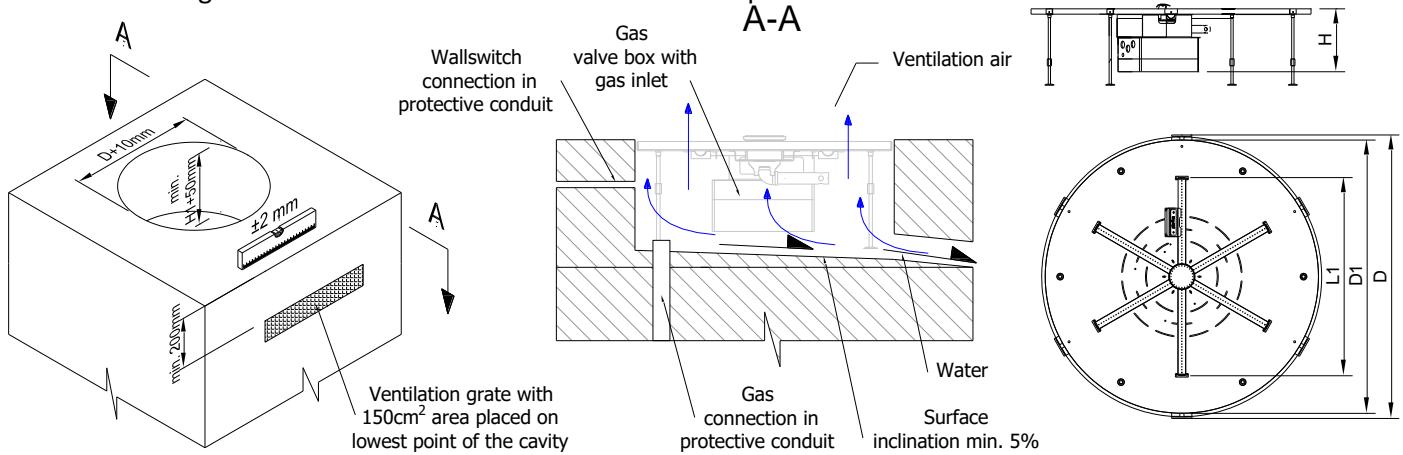

4.2. Installation of glass screens

- Carefully remove cardboard and foam foil from the glass guards.
- Remove all contaminations from the glass guards which could burn out on the glass during operation of the (in particular fingerprints).
- Install glass guards in the corresponding slots on the appliance

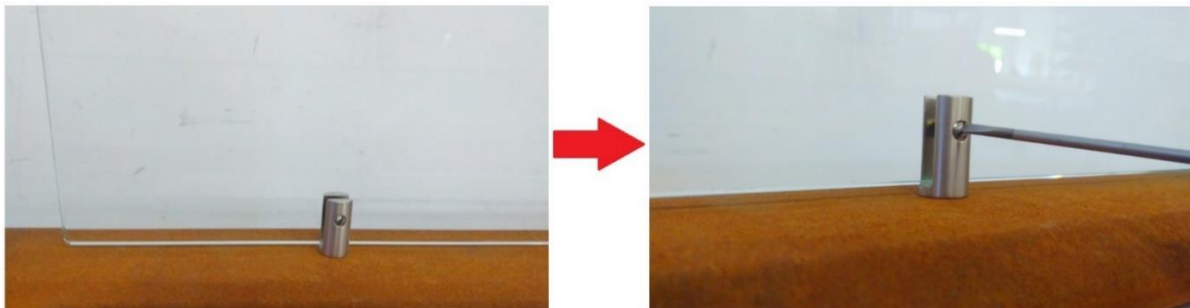

Glass guards installation

- Remove the glass guards only in case of damage of the glass.

4.3. Installation of the gas linkage

Warning!!! The installation and service needs to be conducted by a qualified professional, a company or the gas supplier.

Before proceeding with the connection of the gas cylinder to the fireplace all activity regarding the correct placement and installation of the Galio Star Insert Automatic needs to be already performed. Place the gas piping/hose away from hot or sharp edges and make sure any flexible connections are not twisted, located out of pathways or in areas where the hose may be subject to accidental damage and installed in accordance with AS/NZS 5601.1. Gas inlet is located under the device in grey valve box.

4.3.1. Natural gas connection

First and foremost, make sure that the connecting device is designed to supply a gas suitable for the type placed in the gas installation. All necessary information regarding the desired parameters of the gas are found on the rating plate of the device. Before connecting the gas supply, it is necessary to blow them to remove any remaining metal filings and other contaminants from inside. Automatic gas control system should be protected from moisture and dust. These factors may cause irreparable damage to the individual components. The pipe supplying gas to the fireplace should be equipped with a ball valve with a recommended diameter of 1/2 inch. The individual elements of the gas installation cannot be sealed using Teflon tape or PTFE tape.

The gas valve on the gas pipe must be installed in accordance with AS/NZS 5601.1. Before connecting the gas, make sure that the gas pipes and connections have no dirt. Gas connection is finished with external thread 3/8 ". Regarding gas connection, the following requirements shall apply:

- You must use the gas pipe with the correct dimensions, so there is no pressure loss.
- Ball gas valve should be installed in an easily accessible place.

4.3.2. Connection and replacement of the gas cylinder (LPG version)

The Galio Star Insert Automatic is delivered together with an AS/NZS 1869 certified hose assembly which, on one end is connected to the valve of the appliance and on the other end to the AS 4621 certified 2.75kPa regulator (LCC27 connection) ready to be connected to the gas cylinder. The hose and regulator assembly must be checked at each time a new cylinder is connected, for any damage or deterioration such as cracks, cuts, abrasions. If in any doubt contact the place of purchase for a suitable replacement.

The Galio Star Insert Automatic fireplace is suitable for use with 4.5kg-9kg propane cylinders.

WARNING!!! NEVER use an unstable gas connection or a regulator for other gas pressure.

Where an AS/NZS 1869 certified hose assembly is connected to piping ensure it is protected during servicing with a restraint chain/tether 80% of the hose length.

5. OPERATING INSTRUCTIONS

The Galio Star Insert Automatic fireplace has a remotely control valve with a built-in ignition for the pilot flame. The flame height of the main burner may be appropriately regulated by Wall Switch (Touch Panel) or remote control

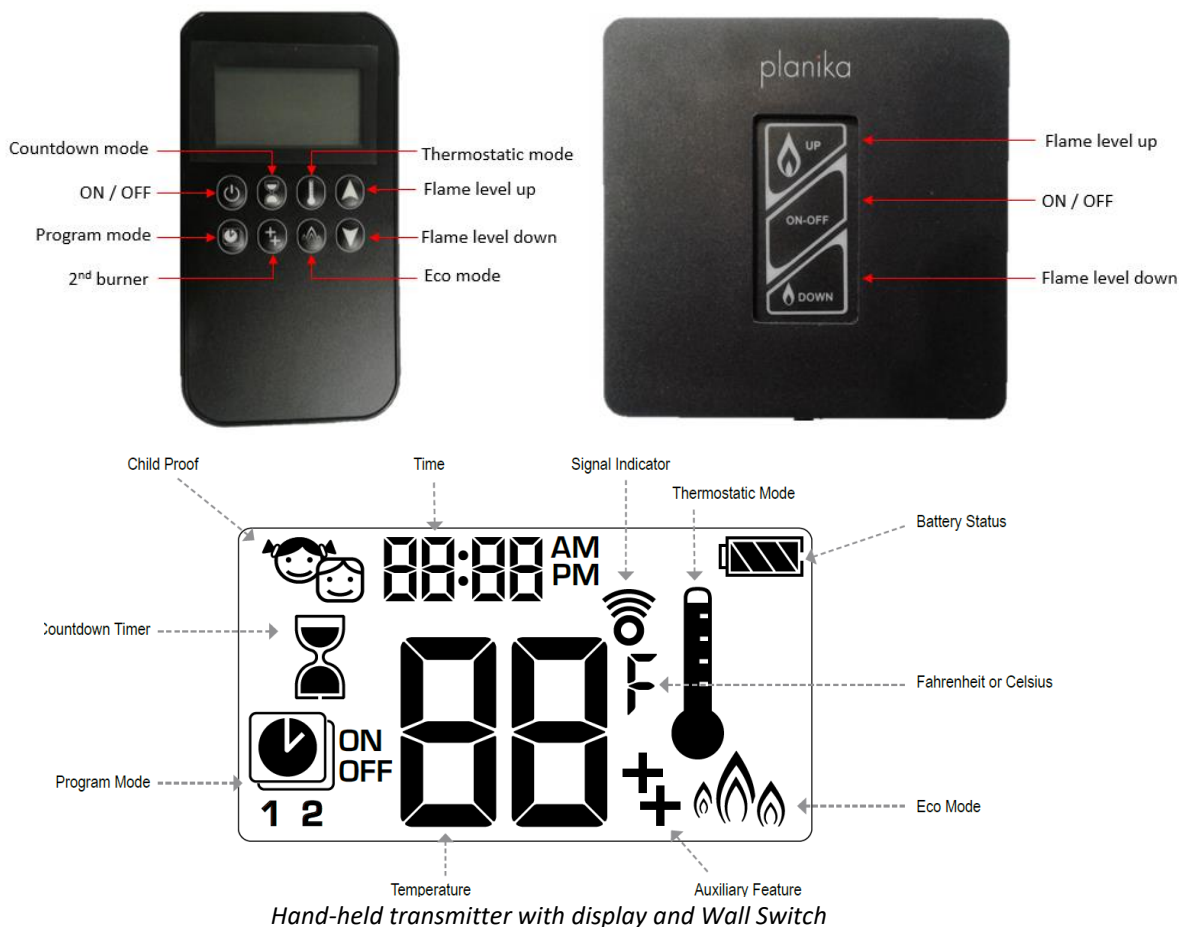

5.1. Setting up signal code

WARNING! You only need to set up the signal code once. It is not necessary when changing the batteries of the hand-held transmitter or receiver. **The appliance is delivered already configured and ready to work.**

In case of lost or damaged of hand-held transmitter the new one has to be programmed and the receiver must first learn the hand-held transmitter's signal code before the first use.

Press and hold the receiver's reset button until you hear two (2) beeps. After the second, longer beep, release the reset button. Within the subsequent 20 seconds press the button „“ on the handset. **"CONN" and a running number from 1 to 8 are displayed** on the handset confirming the synchronization **and data exchange** is in process **Two (2) short beeps confirm the code is set.** After successful synchronization the current state of the gas fire is displayed on the handset. **The receiver is located in the grey gas box underneath the insert.**

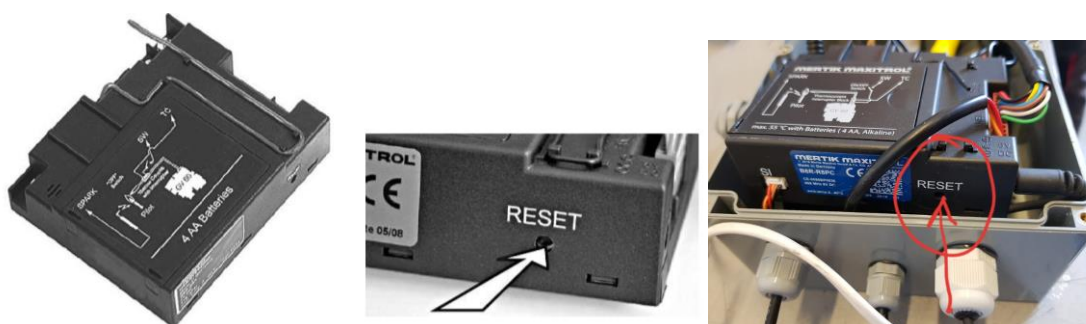

Receiver "RESET" button

5.2. Installing the control unit (Wall Switch)

The control unit has standard cable with a length of 8 m

NOTE: The cables **may not** be extended. Longer cables can pick up environmental signals that can switch the appliance uncontrolled On or Off.

- Determine the location for the control panel (Wall Switch) taking into account the size of the box on backside.



Size of the wallswitch

- Unscrew the sealed box on backside of the wallswitch.



Opening the back of the wallswitch

- Unscrew the cable gland and disconnect the wires by pushing grey switch, pull out the connection from the sealed box.

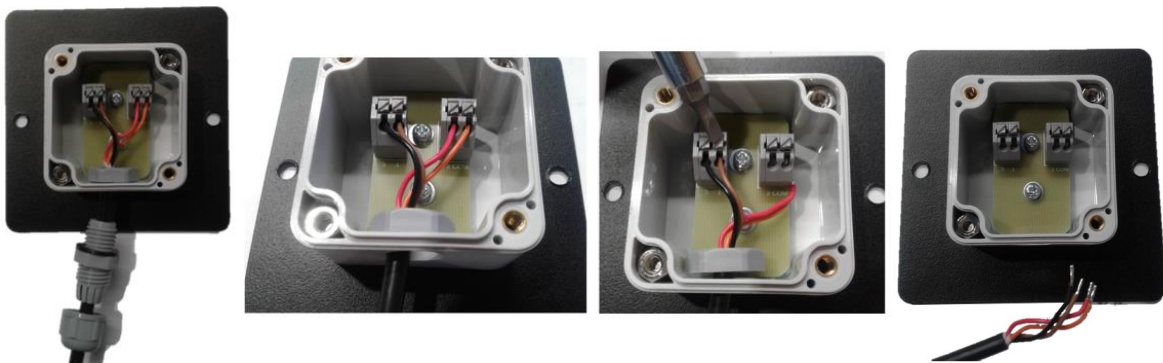

Wire connection

- Pull the cable through protective conduit (min. 2cm diameter) in a way that it would be easily removable. Notice that conduit will not be supplied by the producer.



Protective conduit

- Connect the wires back and screw the cable gland. Screw back the cover of sealed box.

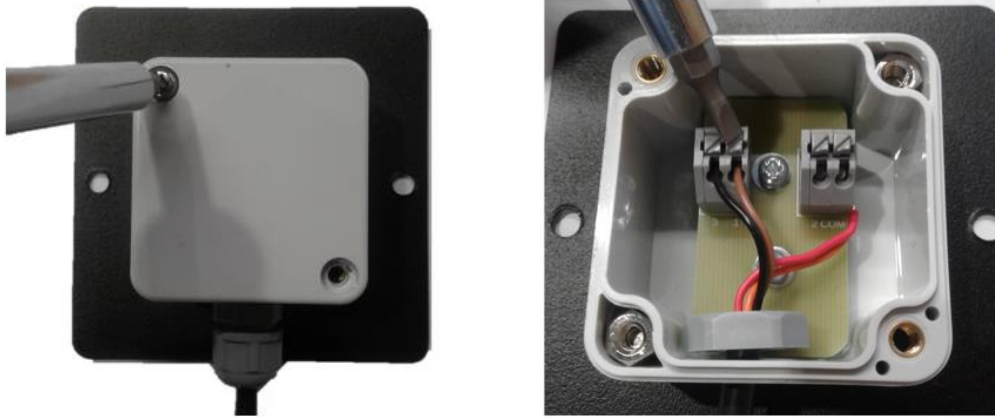

Closing the back of the wallswitch

- Mount the control panel via pre made holes. Cover the fasteners by placing the magnesium sticker on the front of the panel



Location of mounting holes and magnetic sticker

5.3. Installing the battery box

- Determine the location for the battery box (Fireplace will be equipped with 5m cable, battery box with 1,5m)
- Connect the battery box with the cable



Battery box connection

5.4. Installation to the electricity mains (optionally)

- Determinate the location for the power socket. Use waterproof socket to protect in against humid.
- Unplug the battery cable and connect the 6V DC power adapter to it. The other end of the adapter connect to the power socket. (Use only power adapter supplied by the producer).
- Lead the cable in protective conduit (min. 2cm diameter) in a way that it would be easily removable.

Notice that conduit will not be supplied by the producer.

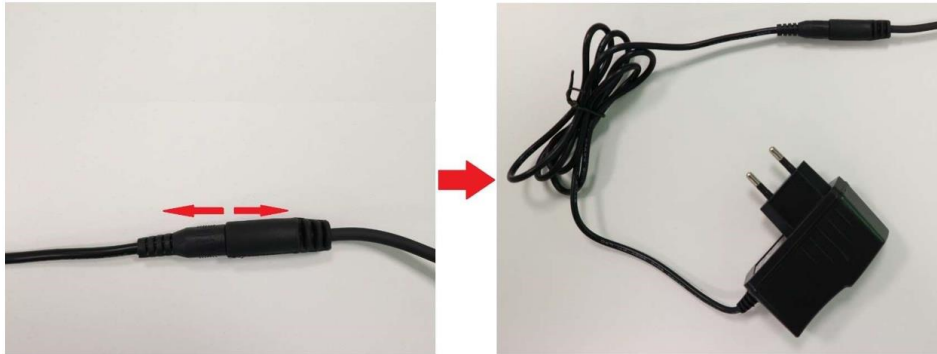

5.5. Replacing the batteries

If the batteries are inserted incorrectly, the electronics or drive may be irreparably damaged. Only replace the batteries when the appliance has been completely switched off.

NOTE: If the appliance is equipped with a 230 VAC connection, no batteries are present in the receiver or in battery box.

- The battery are placed in battery holder.



Battery box

- Open the battery holder by unscrewing the 4 screws

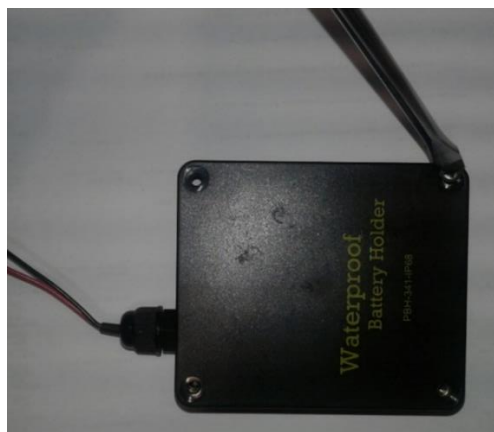

Unscrewing battery box

- Replace 4 pieces of AA/LR6 Alkaline long live batteries.



Replacing battery in battery box

- Close the battery holder by screwing the 4 screws back

5.6. Remote control



Galio Star Insert Automatic can be operated by radio remote control. This comprises a hand-held transmitter and a receiver. The receiver is part of the gas control block assembly.

- Electrical connections and batteries:
 - Hand-held transmitter: 2x 1.5V AAA battery
 - Receiver: 4x1.5V AA battery or 6 VDC











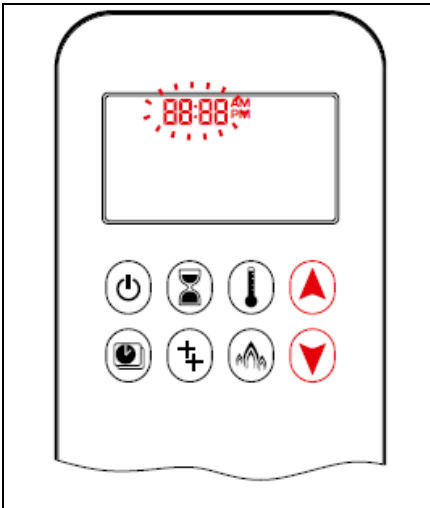



WARNING! Without using a mains adapter, battery replacement is recommended at the beginning of each heating season. Old or dead batteries should be removed immediately. If left in the unit the batteries can overheat, leak, and / or explode. Do NOT expose batteries (including during storage) to direct sunlight, excessive heat, fire, moisture, or severe impact. Each of these conditions can cause the batteries to overheat, leak, and / or explode. Batteries must be kept within their recommended temperature limits. Ambient battery temperature range: 32 °F to 131 °F[0°C to 55°C].

- The hand-held transmitter batteries have a service life of approx. one year. We recommend you use alkaline batteries. Rechargeable batteries are not permitted.
- To replace batteries:
 - Open the cover on the back of the remote control.
 - Remove the batteries from the battery compartment.
 - Place two new 1.5V batteries (LR03 or AAA type) as indicated in the battery compartment.
 - Close the cover







5.6.1. Setting fahrenheit or celsius

	<p>1. To change between ° C and ° F, press  and  buttons simultaneously.</p> <p>NOTE: Choosing ° F results in a 12 hour clock. Choosing ° C results in a our clock.</p>
--	--

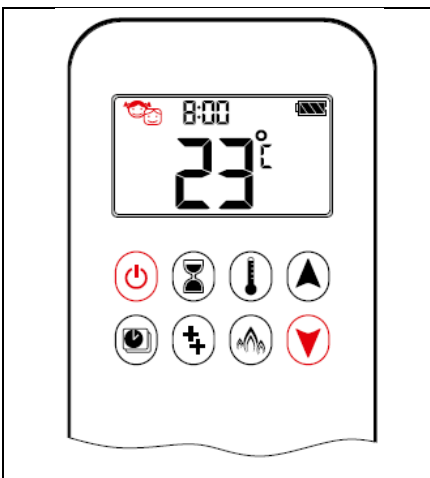
5.6.2. Setting the time

	<ol style="list-style-type: none">1. Press  and  buttons simultaneously. Day flashes.2. Press  or  button to select a number to correspond with the day of the week (e. g. ¹ = Monday, ² = Tuesday, ³ = Wednesday, ⁴ = Thursday, ⁵ = Friday, ⁶ = Saturday, ⁷ = Sunday).3. Press  and  buttons simultaneously. Hour flashes.4. To select hour press  or  button.5. Press  and  buttons simultaneously. Minutes flash.6. To select minutes press  or  button.7. To confirm press  and  buttons simultaneously or wait.
--	--





5.6.3. Child proof

	<p>ON:</p> <ol style="list-style-type: none">1. To activate press  and  buttons simultaneously.  displayed and the handset is rendered inoperable, except for the off function. <p>OFF:</p> <ol style="list-style-type: none">2. To deactivate press  and  buttons simultaneously.  disappears.
---	---

5.6.4. Switch the Fire ON and OFF

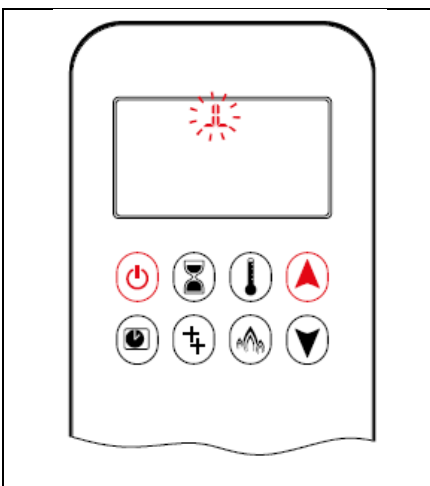
Before operating make sure MANUAL knob on the GV60 valve is in the **ON**, full counter clockwise position.

WARNING! When the pilot light is ignited, the motor turns automatically to maximum flame height. If the pilot flame goes out for any reason, wait for 5 minutes before attempting to re-light it. If the pilot does not stay lit after several tries, turn the main valve knob to **OFF**.

	<ol style="list-style-type: none">1. Open the valve of the gas cylinder (or gas supply valve in the gas pipe).2. Press  button (One Button Ignition) or  and  button simultaneously (Two Button Ignition) until two short beeps and a blinking series of lines confirms the start sequence has begun; release button(s).3. Main gas flows once pilot ignition is confirmed.4. Handset automatically goes into Manual Mode after main burner ignition.5. Press  button to turn OFF.6. NOTE: A new ignition is possible after the OFF icon stops flashing.
--	--

- This can take few seconds to ignite to pilot flame especially when you have replaced and installed a new LPG gas cylinder.
- If the pilot light does not ignite after 3 ignition attempts close the gas tap and contact the fitter.
- Once the pilot light is burning, the main burner must ignite within 10 seconds automatically. If this does not happen, immediately close the gas tap and contact the fitter.
- If the main burner ignites with a pop immediately close the gas tap and contact the fitter.
- If the appliance is not to be used for some time, please close the gas supply valve in the gas pipe (or valve of the gas cylinder).

WARNING! If the pilot flame goes out for any reason wait for 5 minutes before attempting to re-light it.

WARNING!!!



- Under conditions of increased humidity (rain, breeze, fog, dew, etc.), there may be some temporary problems with switching on the fireplace. This is a normal phenomenon associated with the dampening of the ignition element.
- Before switching on the fireplace, wait until the ignition element has dried completely.
- You can speed up this process by blowing the pilot flame with compressed air to remove the accumulated moisture. The properly fired pilot flame consist of 3 smaller parts.





5.6.5. Stand-by mode (Pilot flame)

	<p>1. Press and hold  button to set appliance to pilot flame.</p>
--	--



5.6.6. Flame height adjustment

	<p>1. To increase flame height press and hold  button.</p> <p>2. To decrease flame height or to set appliance to pilot flame, press and hold  button.</p>
--	---











5.6.7. Flame height directly to minimum position

	<p>1. To go to low fire, double-click  button. LO is displayed.</p> <p>NOTE: Flame goes to high fire first before going to low fire.</p>
---	---

5.6.8. Flame height directly to maximum position

	<p>1. To go to high fire, double-click  button. HI is displayed.</p>
--	--

5.6.9. Countdown timer

	<p>ON / SETTING:</p> <ol style="list-style-type: none">1. Press and hold  button until  displayed, and hour flashes.2. To select hour press  or  button.3. To confirm press  button. Minutes flash.4. To select minutes press  or  button.5. To confirm press  button or wait. <p>OFF:</p> <p>Press  button,  and countdown time disappear.</p>
---	--

5.6.10. Automatic Turn Down To Pilot

3 Hour No Communication Function

The valve will turn to pilot flame if there is no communication between handset and receiver for a 3 hour period. The fire will continue to function normally when communication is restored.

Receiver Overheating

- Powered by mains adapter: The valve turns to pilot flame if the receiver temperature is higher than 176 °F (80 °C). If batteries are installed in the receiver in this configuration the temperature must not exceed 60 °C.
- Powered by batteries and/or connected to the V module: The valve turns to pilot position if the temperature in the receiver is higher than 140 °F (60 °C).

NOTE: When the receiver temperature is below 140 °F (60 °C), the main burner can be turned ON manually.

5.6.11. Automatic Shut Off

Countdown Timer

At end of countdown time period, the fire shuts off. The Countdown Timer only works in Manual, Thermostatic, and Eco Modes. Maximum countdown time is 9 hours and 50 minutes.

Low Battery Receiver

The system will shut down the fire completely if the batteries reach a low power level while burning. This will not happen if the burner is connected to the optional mains adapter and power is lost.

On-Demand Pilot

- This green feature eliminates gas energy consumption during extended appliance inactivity. When the appliance is inactive for an extended period of time the system automatically extinguishes the pilot. This feature helps the consumer realize cost benefits by automatically eliminating energy consumption during non-heating months and limited use.
- The programmed length of inactivity to activate the system is specified by the appliance manufacturer and cannot be altered in the field.

5.7. Wall Switch



To Turn ON Appliance

- Press **ON-OFF** button until two short beeps confirm the start sequence has begun; release button.
- Once pilot ignition is confirmed, there is main gas flow.



Standby Mode (Pilot Flame)

- Press and hold  **DOWN** (small flame) button to set appliance at pilot flame.

To Turn OFF Appliance

- Press **ON-OFF** button.

Flame Height Adjustment

- Press and hold  **UP** (large flame) button to increase flame height.
- Press and hold  **DOWN** (small flame) button to decrease flame height or to set appliance at pilot flame.

6. TESTING

WARNING!!! NEVER TURN ON THE DEVICE IF THE CHARACTERISTIC SMELL OF GAS IS PERCEPTIBLE.

If you smell gas during the operation of the fireplace turn off the device immediately and cut off the gas supply from the gas cylinder by shutting its valve.

6.1. Checking for gas leaks

- Check if all connections are airtight.
- To do that apply all connections with soapy water (or water with another foamy substance) or with a professional spray for leak detection.
- If air-bubbles are present that means the connection has a leak.
- Remove the leaks in the identified spaces.
- Check for leaks once again.
- After the inspection dry the inspected connections.
- The device may only be used again after all leaks are removed.
- **If the problem happens again please contact the dealer.**

6.2. Checking the flame appearance

- Burn the Galio Star Insert Automatic on max flame height and check the appearance of the flame.
- Each flame segment should be linear. The flame should evenly burn on the whole length of each burner.
- If visible gaps are present or there are substantial differences in flame height turn off the fireplace and after the device is cooled adjust the placement of decorative stones in such a way for them to be evenly placed on the whole surface of the main burner.
- Turn on the fireplace and check the appearance of the flame once again.

WARNING!!! Remember not to cover the cover, which houses the ignition and the pilot flame, with stones!

7. MAINTENANCE AND UPKEEP

We recommend cleaning the pilot flame and the main burner unit before the device is started again after its been removed from storage during the winter period.

7.1. Testing and cleaning

Please check and clean if necessary:

- The main burner - if necessary, remove broken parts of stones and the existing dust.
- Pilot burner and thermo-couple (if necessary, remove the existing sediment). In the event of visible damage contact your dealer.
- Igniter - gap between igniter and pilot flame should not be bigger than 5 mm.
- Gas linkage and pressure regulator (in case their expiry date is invalid replace these ancillaries for new ones).
- If you encountered problems with the regulator, gas linkage, burner or regulation valves do not try to fix these parts. Contact a sales person, an authorised service or an importer in order to acquire spare parts. To ensure the device is working efficiently use only original spare parts.

8. TROUBLESHOOTING

Warning! Montage, upkeep and service need to be conducted by a qualified professional with appropriate qualification, an appropriate company or the gas supplier.

PROBLEM	POSSIBLE CAUSE	CORRECTIVE ACTION
SMELL OF GAS	CLOSE THE VALVE ON THE GAS CYLINDER IMMEDIATELY. DO NOT USE THE DEVICE UNTIL LEAKS HAVE BEEN REMOVED.	
Leak detected at cylinder, regulator or other connection.	<ol style="list-style-type: none"> 1. A loose regulator linkage. 2. Leak in the gas linkage, in the regulator or on the gas knobs. 	<ol style="list-style-type: none"> 1. Tighten and test it. 2. Report this issue to service.
Burner does not ignite	<ol style="list-style-type: none"> 1. The bottle is empty. 2. Igniter linkage is not connected. 3. No ignition spark. 4. The igniter electrode is placed incorrectly opposite the igniter. 5. Gas nozzles are blocked. 6. Gas linkage is twisted. 7. Pressure regulator link is loose. 	<ol style="list-style-type: none"> 1. Replace Gas Cylinder. 2. Connect the igniter linkage. 3. Replace igniter. 4. Realign electrode and clear any surrounding debris from area. 5. Unmount burner, clean the nozzle. 6. Straighten the linkage. Keep the linkage away from the housing. 7. Tighten the link. Check for leaks.
Igniter Not Working	<ol style="list-style-type: none"> 1. Ignitor wire not connected. 2. Electrode misaligned on pilot burner 3. Igniter malfunction 	<ol style="list-style-type: none"> 1. Ensure pilot electrode wire is connected. 2. Realign electrode and clear any surrounding debris from area. 3. Replace Igniter
Low efficiency, „cracking” sounds	<ol style="list-style-type: none"> 1. The bottle is empty. 2. The nozzles of the burner are blocked. 	<ol style="list-style-type: none"> 1. Replace Gas Cylinder. 2. Unmount the burner, clean the nozzle.
Thumping sounds made by the regulator.	The cylinder valve has opened rapidly.	Unfasten the bottle valve slowly.
A vivid/ bright orange and smoky flame of the burner.	Holes blocked in the apparatus producing the gas and air mixture.	Unmount the burner and clean/ unblock the apparatus' holes.

There are many factors that may affect the malfunction of the gas insert. To exclude a possible fault in the unit or the automatic gas control system, make sure that the fireplace is connected according to these instructions.

Below table summarizes possible failures that may occur, possible causes and ways to solve them.

Failure code	Message shown in app	Description	Possible cause
F02	F02 Contact Service.	Wiring Motor and/or Microswitch.	No Motor end stop found Wiring to Motor Microswitch connection or function Bent Motor Knob
F03	F03 Contact Service.	Thermocouple wiring wrong or interrupted, or kill switch open.	Thermocouple wiring wrong or interrupted ON/OFF switch at Valve open
F04	F04 Ignition Sequence Malfunction. Wait 1 minute. Retry ignition.	No pilot flame within 30 sec; Remark: after 3 times failure F06 will be cre- ated.	No gas supply Air in pilot supply line No spark Wrong polarity in Thermocouple wiring
F06	F06 Contact Service.	No pilot flame within 30 sec for 3 times within 5 Minutes.	No gas supply Air in pilot supply line No spark Wrong polarity in Thermocouple wiring
F10	F10 Contact Service.	2nd Thermocouple did not sense flame.	Logs out of position
F12	F12 Contact Service.	Limit temperature exceeded (T> 60 °C); Motor turns down to pilot.	V Module connected Receiver equipped with back up batteries
F13	F13 Contact Service.	Limit temperature exceeded (T> 80 °C); Motor turns down to pilot.	V Module not connected Receiver not equipped with back up batteries
F14	F14 Contact Service.	Receiver software doesn't support a 2nd Ther- mocouple.	Wrong Receiver type
F15	F15 Contact Service.	2nd Thermocouple is not connected to the Receiver.	- Wiring of 2nd Thermocouple not connected or damaged
F16	F16 Handset out of range.	No temperature value from Handset found for 1,5 h.	No Handset in range
F17	F17 Contact Service.	Measure range malfunction Vcc > 7,25 V.	Wrong or malfunctioning Mains Adapter
F19	F19 Contact Service.	Pilot drops when Motor opens the main gas.	Not enough thermovoltage Bad Thermocouple Low inlet pressure Valve

Failure code	Message shown in app	Description	Possible cause
F26	F26 Contact Service.	Motor up prohibited after ignition / Fan at level 4 for 10 minutes (T > 60/80 °C).	- Receiver temperature still above 60/80 °C
F28	F28 5 Day Shut OFF.	5d Timer expired or switched off at low bat- teries.	No Motor turn for 5 days Empty Receiver batteries
F31	F31 Contact Service.	Electronic malfunction.	Misconnection, short, high voltage Overheating
F41	F41 Check Wi-Fi.	No or bad Wi-Fi connection.	No or bad Wi-Fi connection
F42	F42 Check Wi-Fi.	No myfire Wi-Fi box found.	No power myfire Wi-Fi Box is not connected to the Home Network Incorrect myfire Wi-Fi Box version
F43	F43 No Receiver Connected. Contact Service.	No Receiver connected to myfire Wi-Fi Box or bad connection.	Defect or loose wire between Receiver and myfire Wi-Fi Box
F44	F44 Missing temperature Sen- sor. Contact Service.	No Temperature Sensor found (Handset or NTC)	No Handset available or no Temperature Sen- sor connected

Failure code	Message shown in handset	Duration displaying	Description	Possible cause
F04	F04	4s	No pilot flame within 30 sec Remark: after 3 times failure F06 will be created.	No gas supply Air in pilot supply line No spark Wrong polarity in thermocouple wiring
F09	F09	4s	The Receiver has not been paired with the Handset.	Down arrow button was not pressed during pairing
F40	Battery Symbol	Permanent	Low battery power in Handset.	Replace Handset batteries
F46	F46	4s	No or bad connection between Receiver and Handset.	No power at Receiver Low communication range

9. PRESSURE ADJUSTMENT

Do not attempt to remove screws from the top of gas valve. Do not change any adjustments marked with tamper indicating paint. Motor knob is not to be removed.

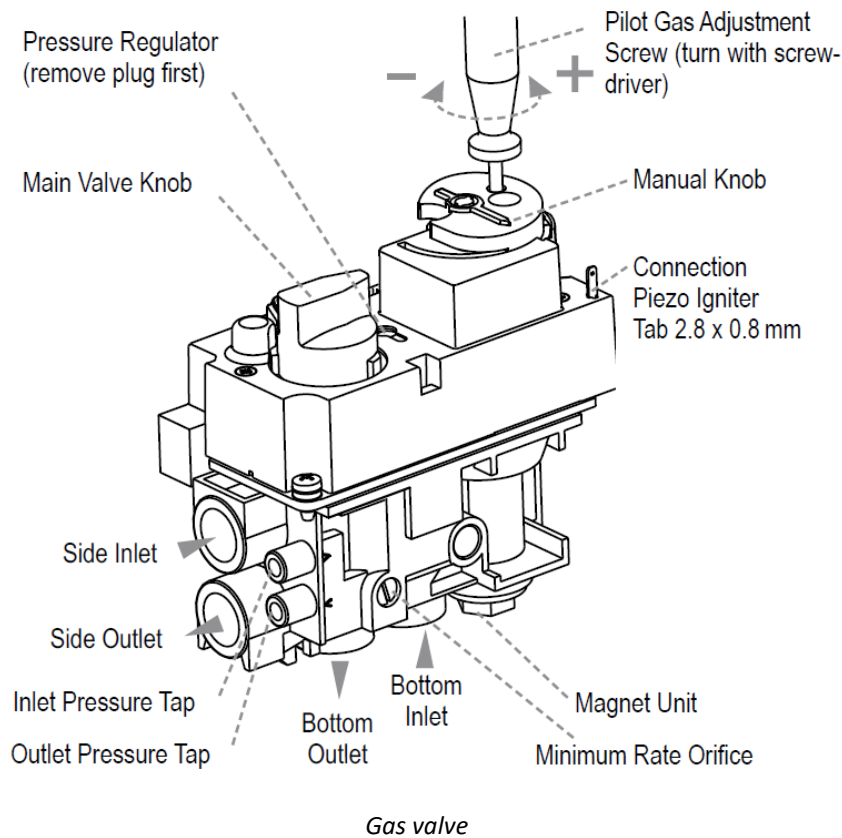

- **Pilot Flame Adjustment**

The pilot flow adjustment is preset to maximum at the factory. The pilot flame should envelope $\frac{3}{8}$ " to $\frac{1}{2}$ " of the thermocouple

- The adjustment screw can be reached through a hole in the MANUAL knob
- Turn the MANUAL knob to the ON position.
- It is now possible to pierce through a film on the cover with a screwdriver to reach the adjustment screw beneath.
- Turn the adjustment screw clockwise to decrease or counterclockwise to increase pilot flame.

- **Outlet Pressure Adjustment (High Fire)**

- Connect a pressure manometer to the valve outlet pressure tap. Pressure tap is opened by turning the screw counterclockwise. Pressure regulator or throttle are located under the cover and can be reached by removing the plug
- Turn MANUAL knob and main valve knob to the ON position.
- Turn pressure regulator adjustment screw to set required burner pressure (high fire). Pressure is increased by turning clockwise (pressure regulator models), or decreased by turning counterclockwise: LPG 2.0kPa, NG 0.6kPa

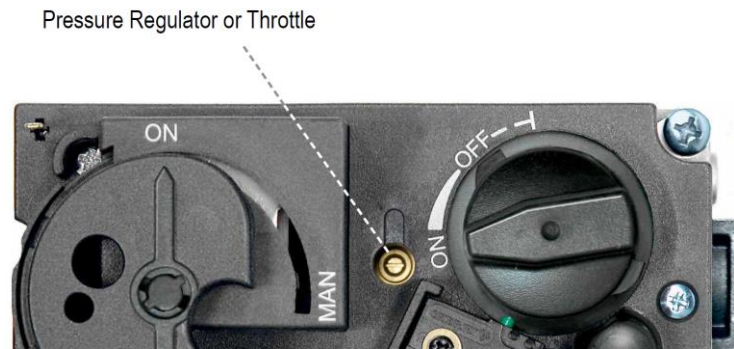

Outlet pressure adjustment

- After adjustment, replace the plug.
- If no other adjustments are required, close pressure tap(s) by turning the screw(s) full clockwise. Check all connections/pressure tap(s) for leaks.
- If the desired outlet pressure or flow cannot be achieved by adjusting the gas valve, check the gas valve inlet pressure using a manometer at the valve inlet pressure tap. If the inlet pressure is in the normal range, replace the gas valve; otherwise, take necessary steps to assure proper gas pressure to the valve

- **Minimum rate Adjustment**

- Connect a pressure manometer to the valve outlet pressure tap. Pressure tap is opened by turning the screw counterclockwise. Minimum rate adjustment screw is located on the top of the metal valve body.
- Turn minimum rate adjustment screw to set required burner pressure (minimum fire). Pressure is increased by turning clockwise (pressure regulator models), or decreased by turning counterclockwise: LPG 1.2kPa, NG 0.37kPa

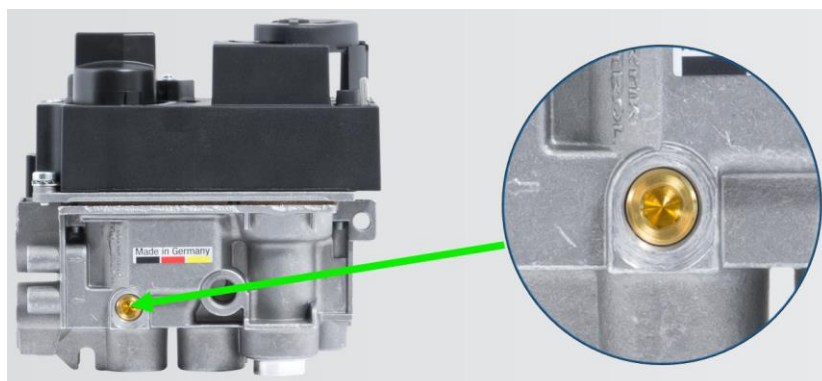

Minimum rate adjustment

WARNING! You should never connect any device adapted to the combustion of liquefied gas to the gas network of natural gas and vice versa.

- **Pressure reading**

- Unscrew gas valve box cover using cross screwdriver.

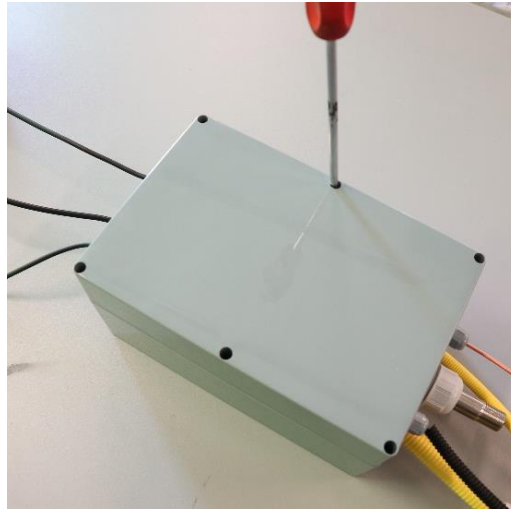

Back of the valve box

- Take off the cover.

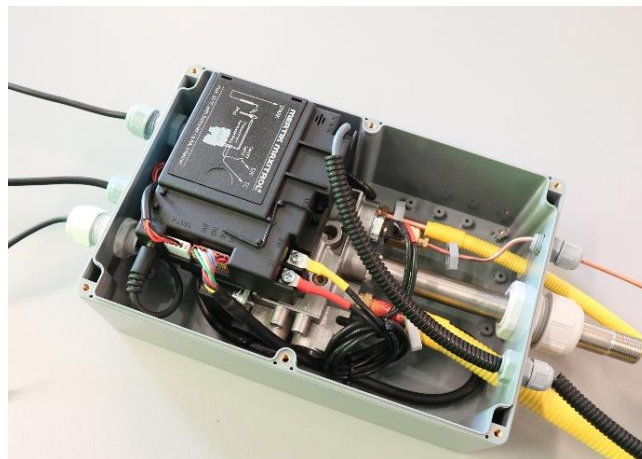

Valve box elements

- Slightly take out the valve unit from valve box
- Unscrew the screw on the test tap by half a turn.
 - A) Inlet pressure tap
 - B) Outlet pressure tap

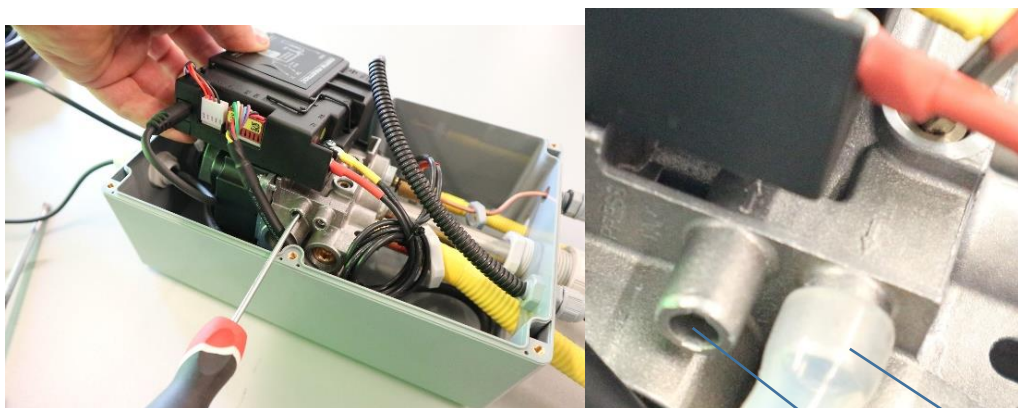

Test taps

- Connect the silicon hose from measure device to the measure tap.

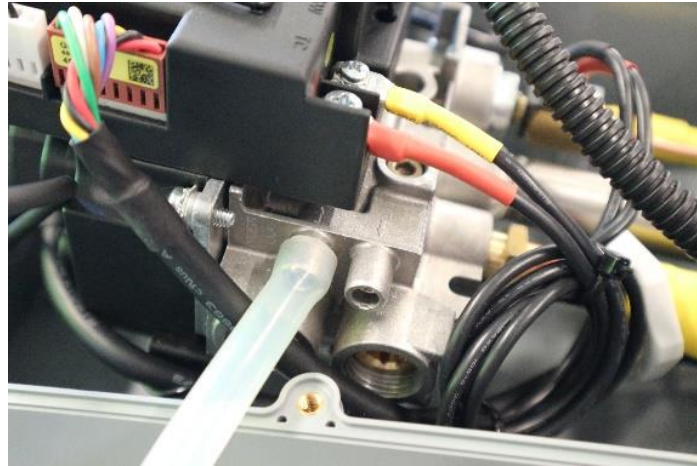

Silicon hose on testing tap

- Read the pressure value. Pressure test has to be made when fireplace is turned on with the highest flame level.

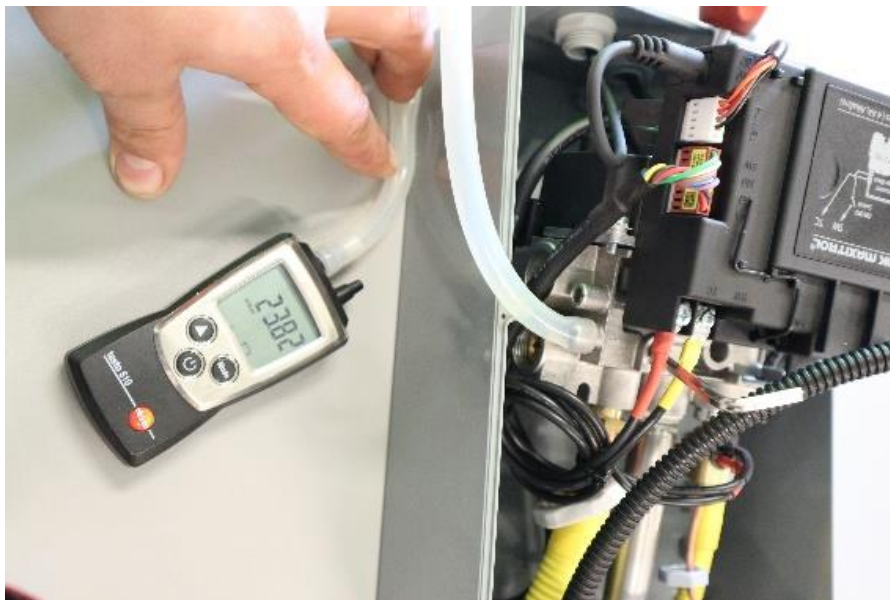

Testing pressure



- Screw tightly the screw on the test tap
- Turn on the device and check if screw is sealed using gas detector, foam or other method.
- Put on gas valve cover and screw it back.

10.ELECTRICAL DIAGRAMS

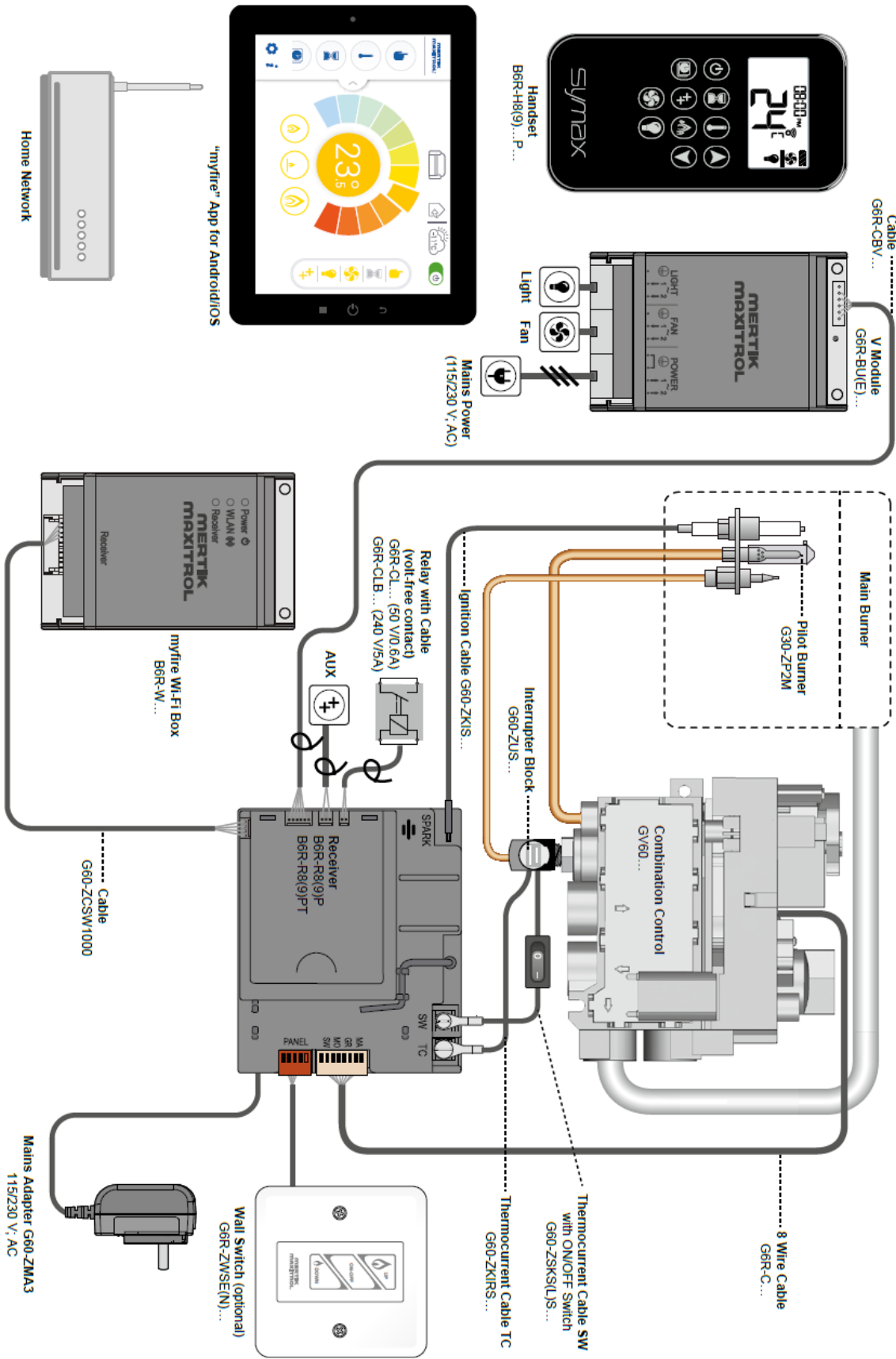
WARNING! V module is not available



11. TECHNICAL SPECIFICATION

<p>Manufactured by: Planika Sp. z o.o. Bydgoskich Przemysłowców 10 85-862 Bydgoszcz Poland</p>	 <p>DO NOT REMOVE AUSTRALIA ONLY GAS SAFETY CERTIFICATION</p>	
<p>GMK10583</p>	<p>Model No.</p>	<p>Galio Star Insert</p>
	<p>Serial No.</p>	<p>FO xxxx xx</p>
	<p>Gas Type</p>	<p>NG</p>
	<p>Index</p>	<p>GO-xxxx-xx</p>
	<p>Date of Manufacture</p>	<p>xx/xxxx</p>
	<p>Nominal Injector Size (mm)</p>	<p>4.2</p>
	<p>Pilot flame injector (mm)</p>	<p>2 x 0.2</p>
	<p>Inlet Pressure (kPa)</p>	<p>1.13</p>
	<p>Test Point Pressure (kPa)</p>	<p>0.6</p>
	<p>Turndown Test Point Pressure (kPa)</p>	<p>0.37</p>
	<p>Nominal Gas Consumption (MJ/h)</p>	<p>63.0</p>
	<p>Turndown Gas Consumption (MJ/h)</p>	<p>48.7</p>
<p>Primary Aeration Setting (mm)</p>	<p>1/2 open</p>	
<p>SUITABLE ONLY FOR OUTDOOR INSTALLATION</p>		
<p>DO NOT OPERATE IN AN ENCLOSED AREA</p>		
<p>DO NOT OPERATE IN AN UNVENTILATED AREA</p>		
<p>DO NOT OPERATE INDOORS</p>		
<p>DO NOT OPERATE THIS APPLIANCE BEFORE LEAK CHECKING HOSES AND GAS CYLINDER CONNECTION</p>		
<p>TO BE INSTALLED ON FIRE RESISTANT MATERIAL</p>		
<p>FOR OUTDOOR USE ONLY</p>		
<p>THE INSTRUCTIONS PACKAGED WITH THIS APPLIANCE CONTAIN IMPORTANT INFORMATION ABOUT INSTALLATION AND USE</p>		
<p>TO BE INSTALLED ONLY BY AN AUTHORIZED PERSON IF CONNECTING TO FIXED CONSUMER PIPING</p>		

Manufactured by:
 Planika Sp. z o.o.
 Bydgoskich Przemysłowców 10
 85-862 Bydgoszcz
 Poland



planika
 INTELLIGENT FIRE

GMK10583	Model No.	Galio Star Insert
	Serial No.	FO xxxx xx
	Gas Type	LPG
	Index	GO-xxxx-xx
	Date of Manufacture	xx/xxxx
	Nominal Injector Size (mm)	2.4
	Pilot flame injector (mm)	1 x 0.2
	Inlet Pressure (kPa)	2.75
	Test Point Pressure (kPa)	2.0
	Turndown Test Point Pressure (kPa)	1.2
	Nominal Gas Consumption (MJ/h)	63.0
	Turndown Gas Consumption (MJ/h)	48.2
Primary Aeration Setting (mm)	Fully open	
SUITABLE ONLY FOR OUTDOOR INSTALLATION		
DO NOT OPERATE IN AN ENCLOSED AREA		
DO NOT OPERATE IN AN UNVENTILATED AREA		
DO NOT OPERATE INDOORS		
DO NOT OPERATE THIS APPLIANCE BEFORE LEAK CHECKING HOSES AND GAS CYLINDER CONNECTION		
TO BE INSTALLED ON FIRE RESISTANT MATERIAL		
FOR OUTDOOR USE ONLY		
THE INSTRUCTIONS PACKAGED WITH THIS APPLIANCE CONTAIN IMPORTANT INFORMATION ABOUT INSTALLATION AND USE		
TO BE INSTALLED ONLY BY AN AUTHORIZED PERSON IF CONNECTING TO FIXED CONSUMER PIPING		

12. MANUFACTURER'S CONTACT DETAILS

Company Name: Planika Sp. z o.o.
Address: Bydgoskich Przemysłowców 10
Telephone: + 48 52 364 11 60

13. DISTRIBUTOR'S CONTACT DETAILS

Company Name: Planika Australia
Address: 3/2 Cynamide st, Laverton nth, vic 3016, Australia
Telephone: + 61 415 350 564
E-mail: planikaaustralia@planikafires.com