

# peachtree audio





# Grand Integrated

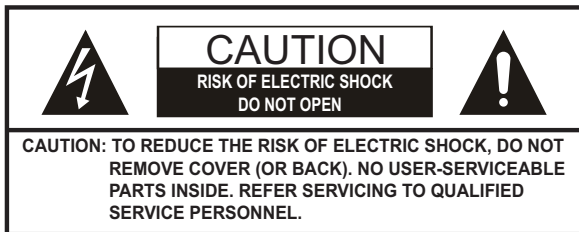

## IMPORTANT SAFETY INSTRUCTIONS

- 1) Read these instructions – All the safety and operating instructions should be read before this product is operated.
- 2) Keep these instructions – The safety and operating instructions should be retained for future reference.
- 3) Heed all warnings – All warnings on the appliance and in the operating instructions should be adhered to.
- 4) Follow all instructions
- 5) Do not use this apparatus near water – The appliance should not be used near water or moisture – for example, in a wet basement or near a swimming pool, and the like.
- 6) Clean only with dry cloth.
- 7) Do not block any ventilation openings. Install in accordance with the manufacturer's instructions.
- 8) Do not install near any heat sources such as radiators, heat registers, stoves, or other apparatus (including amplifiers) that produce heat.
- 9) Do not defeat the safety purpose of the polarized or grounding plug. A polarized plug has two blades with one wider than the other. A grounding plug has two blades and a third grounding prong. The wide blade or the third prong is provided for your safety. If the provided plug does not fit into your outlet, consult an electrician for replacement of the obsolete outlet.
- 10) Protect the power cord from being walked on or pinched particularly at the plugs, convenience receptacles, and at the point where they exit from the apparatus.
- 11) Only use attachments/accessories specified by the manufacturer.
- 12)  Use only with the cart, stand, tripod, bracket, or table specified by the manufacturer, or sold with the apparatus. When a cart is used, use caution when moving the cart/apparatus combination to avoid injury from tip-over.
- 13) Unplug this apparatus during lightning storms or when unused for long periods of time.
- 14) Refer all servicing to qualified personnel. Servicing is required when the apparatus has been damaged in any way, such as power supply cord or plug is damaged, liquid has been spilled or objects have fallen into the apparatus has been exposed to rain or moisture, does not operate normally, or has been dropped.
- 15) Please keep the unit in a good ventilation environment.
- 16) **CAUTION:** These servicing instructions are for use by qualified service personnel only. To reduce the risk of electric shock, do not perform any servicing other than that contained in the operating instructions unless you are qualified to do so.
- 17) **WARNING:** To reduce the risk of fire or electric shock, do not expose this apparatus to rain or moisture. The apparatus shall not be exposed to dripping or splashing and that no objects filled with liquids, such as vases, shall not be placed on apparatus.
- 18) **WARNING:** The mains plug/appliance coupler is used as disconnect device, the disconnect device shall remain readily operable.



- 19) - The lightning flash with arrowhead symbol within an equilateral triangle is intended to alert the user to the presence of non-insulated “dangerous voltage” within the product’s enclosure that may be of sufficient magnitude to constitute a risk of electric shock.
- WARNING: To reduce the risk of electric shock, do not remove cover (or back) as there are no user-serviceable parts inside. Refer servicing to qualified personnel.
  - The exclamation point within an equilateral triangle is intended to alert the user to the presence of important operating and maintenance instructions in the literature accompanying the appliance.
- 20) No naked flame sources, such as lighted candles, should be placed on the apparatus.
- 21) Batteries are included for the remote control. Do not expose these batteries to direct sunlight or excessive heat such as a fire. Care should be taken in the act of battery disposal as they include toxic materials that may harm the environment. Please refer to your local recycling and hazardous waste center for advise with battery disposal.
- 22) WARNING: The terminals marked with symbol of “+/- ” may be of sufficient magnitude to constitute a risk of electric shock. The external wiring connected to the terminals requires installation by an instructed person or the use of readymade insulated leads or cords.
- 23)  Correct Disposal of this product. This marking indicates that this product should not be disposed with other household wastes throughout the EU. To prevent possible harm to the environment or human health from uncontrolled waste disposal, recycle it responsibly to promote the sustainable reuse of material resources. To return your used device, please use the return and collection systems or contact the retailer where the product was purchased. They can take this product for environmental safe recycling.

### Unpacking and Warranty

- 1) Keep all packing materials for future shipments. (service)
- 2) Keep a record of your bill of sale and a copy of the serial number for warranty and insurance purposes.
- 3) You may register your unit on our website: [www.peachtreeaudio.com](http://www.peachtreeaudio.com).

# Grand Integrated

■ Introduction

■ Back Panel

■ Front Panel

■ Connections

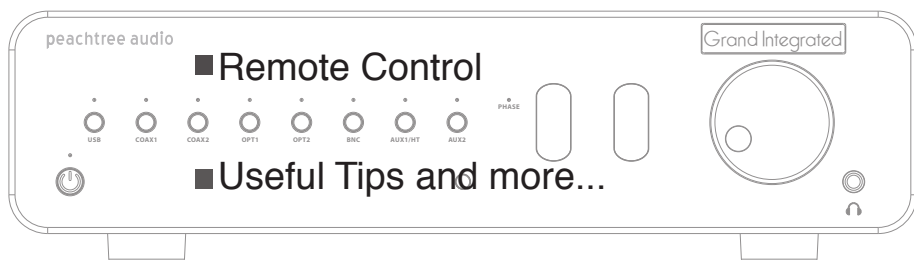

■ Remote Control

■ Useful Tips and more...

■ Troubleshooting

■ Product Guarantee and Service

■ Technical Specifications

Thank you for purchasing the Peachtree Audio Grand Integrated!

At Peachtree Audio we design products that provide a magical musical experience. When you connect the digital output from a Sonos player, a Squeezebox, an Apple TV or Apple Airport Express you'll get the full benefit of the quality built into these products. And when you connect your computer to the Grand Integrated's digital USB input - we think you're going to love what you hear from your music library from compressed music files to high resolution! The icing on the cake is the Grand Integrated's ability to process 24/192khz streams through both the USB and SPDIF inputs. The flexibility and performance of the Grand Integrated make it a must-have in your high end digital music system.

The Grand Integrated is a blend of a high quality – high resolution DAC, a powerful 400wpc amplifier, and a true state-of-the-art hybrid tube preamp. Both analog and digital sources will sound exceptional.

This manual is a guide to the functions of your Grand Integrated. It shows you how to connect both digital and analog sources, and offers tips on getting the best performance. The ability to mate with virtually any digital source, while providing superior sound makes the Grand Integrated a special product. It's one we're proud to offer. We sincerely hope the Grand Integrated provides you with years of enjoyable music listening. Visit our website at [www.peachtreeaudio.com](http://www.peachtreeaudio.com) for tips on getting the best sound from the music stored on your computer, and from all your digital sources. Contact your dealer or us directly if you have questions. Also, now is a good time to go to [www.peachtreeaudio.com](http://www.peachtreeaudio.com) to register your Grand Integrated purchase.

Thanks again - and Happy Listening!

The Folks at Peachtree Audio

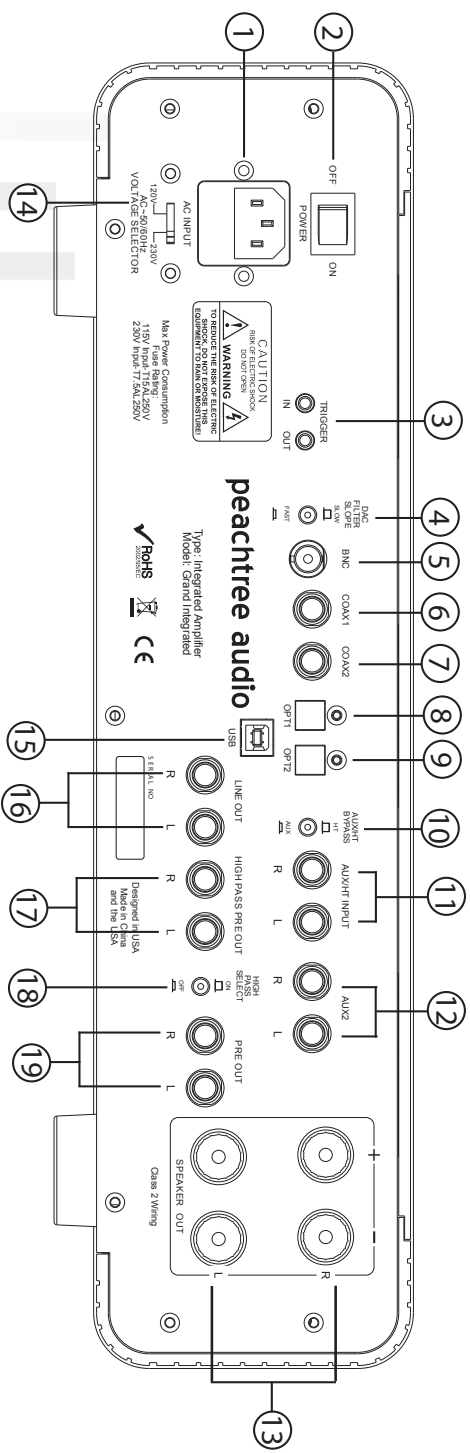

- 1) **AC Power Cord Attachment & Fuse:** The three prong power cord is included in the Grand Integrated box. User replaceable after turning the Grand Integrated off. You may call your dealer or Signal Path's service department with any questions regarding fuse replacement. **\*\*warning\*\*** using the wrong value fuse may cause damage to the Grand Integrated.
- 2) **Power On/Off switch**
- 3) **12V Trigger:** Enables automatic turn on and off from-or-to another source with the same feature.
- 4) **Digital Filter Slope:** User selectable DAC filter slopes allow for a sharp slope which measures better and a soft slope that is preferred by many audiophiles.
- 5) **BNC Digital input:** Generally found on high end computer soundcards and some pro audio products.
- 6) **Coaxial Digital Input 1:** Coaxial digital connections are common on some CD players, cable boxes, Sonos modules, the Slim Devices Squeezebox, and a host of other digital audio sources. Be sure to use a proper digital audio cable for this purpose.
- 7) **Coaxial Digital Input 2:** Coaxial digital connections are common on some CD players, cable boxes, Sonos modules, the Slim Devices Squeezebox, and a host of other digital audio sources. Be sure to use a proper digital audio cable for this purpose.
- 8) **Optical Digital Input 1:** Toslink and fiber optic cable connections are common on some CD players, cable boxes, Apple products, and other digital audio sources.
- 9) **Optical Digital Input 2:** Toslink and fiber optic cable connections are common on some CD players, cable boxes, Apple products, and other digital audio sources.
- 10) **Aux/HT bypass switch:** This selects either Home Theater bypass or standard Aux line input. In HT bypass mode it allows the user to integrate the Grand Integrated in to a Home Theater setup by making Aux1 a "throughput" for the surround processor. This allows you to use the internal amplifier on the Grand Integrated for stereo use and for the front left and right speakers in your Home Theater. **DO NOT** switch to HT while the Grand Intergrated is actively playing music or a soundtrack through this Aux input. The gain stages are different for each selection (HT and Aux) so you may get a loud burst of sound through your speakers. Turn down the volume and put the Grand Integrated in standby. Then select HT. Turn the unit back on and you are ready to use the HT function.
- 11) **Aux/HT Input:** (See #10 above.)
- 12) **Aux2 Analog Input:** Line level input that is suitable for iPods, CD players, Tuners, etc
- 13) **Speaker terminals:** The speaker terminals are clearly marked red-positive and black-negative for proper polarity connections.
- 14) **Voltage Switching:** For international use. Unplug the Grand Integrated before you make the switch and be sure to use the proper fuse for the voltage chosen. **\*\*warning\*\*** Improper voltage setting may cause damage to the Grand Integrated.
- 15) **USB Digital Input:** The USB connection takes digital audio content off your computer and sends it to the internal DAC via I2S configuration.
- 16) **Line Out:** This fixed output will allow the user to feed the Grand Integrated's sources in to another preamp input.
- 17) **High Pass Pre Out:** This unbalanced RCA preamp output will operate in full frequency band when the High Pass switch isn't activated. When the switch is activated it outputs at 80Hz and above with a 12db/octave slope. This high pass filter mode is advised when using a small satellite speaker with a subwoofer.
- 18) **High Pass Switch Selector:** (See #17 above.)
- 19) **Pre-Out:** The preamp-out connections will allow you to use an external amp with the Grand Integrated, and also provide connections for a subwoofer.



\*To dim the front panel lights simply hold down the active input button for a few seconds until the front panel lights dim.

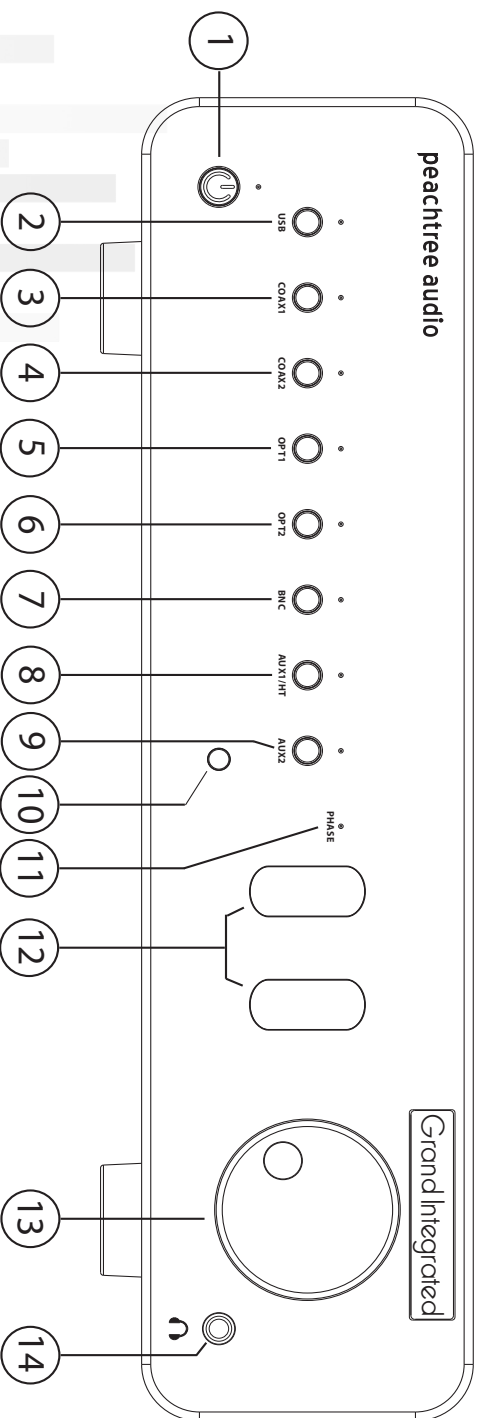

The selector buttons on the Front Panel are very straightforward but we have included additional information for your benefit.

- 1) **Standby Switch:** After turning the Grand Integrated on from the back panel (#2 Power On/Off switch) you can use this button to switch between “ON” which displays a blue light and “Standby” which displays a green light. This function can also be controlled by your wireless remote.
- 2) **USB Digital Input:** The USB connection takes digital audio content off your computer and sends it to the internal DAC via I2S configuration.
- 3) **Coaxial Digital input 1:** Coaxial digital connections are common on some CD players, cable boxes, Sonos modules, the Slim Devices Squeezebox, and a host of other digital audio sources. Be sure to use a proper digital audio cable for this purpose.
- 4) **Coax2 Digital Input 2:** Coaxial digital connections are common on some CD players, cable boxes, Sonos modules, the Slim Devices Squeezebox, and a host of other digital audio sources. Be sure to use a proper digital audio cable for this purpose.
- 5) **Optical Digital input 1:** Toslink and fiber optic cable connections are common on some CD players, cable boxes, Apple products, and other digital audio sources.
- 6) **Optical Digital input 2:** Toslink and fiber optic cable connections are common on some CD players, cable boxes, Apple products, and other digital audio sources.
- 7) **BNC Digital input:** Generally found on high end computer soundcards and some pro audio products.
- 8) **Aux1/HT Analog Input:** (See back panel page.)
- 9) **Aux2 Analog Input:** Line level input that is suitable for iPods, CD players, Tuners, etc
- 10) **IR Window:** For remote control
- 11) **Phase:** When activated by the remote, the led will turn on and both channels of the preamp output will be 180 degrees out of phase. This is to correct sources that stream signals out of phase to the Grand Integrated.
- 12) **Tube Windows:** The tube window is really just for show, but we couldn't resist. There's something about the warm glow of a tube and the kind of sound it produces.
- 13) **Volume Control:** The volume control is motorized from your remote control and has an button indicator to allow the user to see levels from a distance.
- 14) **Headphone Jack:** Plug-in activates mute on other outputs.

- **Coaxial Digital Input:** For connecting the coaxial output from any digital source, using a coaxial digital cable. Push the “COAX” input button on the front of the Grand Integrated to listen.
- **Optical Digital Input (sometimes called Toslink):** For connecting the optical output from any digital source, using an optical digital cable. Push the “OPT” input button on the front of the Grand Integrated to listen.
- **USB Digital Input:** For connecting the USB output from a computer (or other source component which can output audio via USB) using a USB cable. Push the “USB” input button on the front of the Grand Integrated to listen.

**BNC Digital Input:** For connecting a professional sound card to the Grand Integrated. This is a 75 ohm connection that requires a special interconnect cable. Push the BNC input button on the front panel

**Aux Inputs:** For connecting analog inputs (CD player, Tuner, Phono preamp) using RCA interconnects. Aux input buttons are on the front panel, so push the one that corresponds to the Aux input you’re using on the back panel.

**Speaker Terminals:** For connecting high quality speaker wire to your speakers. Please be sure your connections are “In-Phase” (positive on the Grand Integrated connects to positive on the speakers and negative connects to negative)

**Preamp output:** For connecting the variable preamp output of the Grand Integrated to an amplifier. The left and right cables should connect to the left and right inputs of the power amp.

• **Line Output (fixed):** For connecting the Grand Integrated’s left and right line out jacks to line-level (AUX) inputs on a preamplifier, integrated amplifier or receiver. Select any connected digital source from the front panel of the Grand Integrated or from the Grand Integrated remote control. Set your listening level using your existing system’s volume control.

**WARNING: DO NOT CONNECT A FIXED-LEVEL LINE OUTPUT TO A PHONO INPUT OR DIRECTLY TO THE INPUTS OF A POWER AMPLIFIER. YOU MAY DAMAGE YOUR PREAMPLIFIER, RECEIVER, POWER AMPLIFIER AND SPEAKERS!**

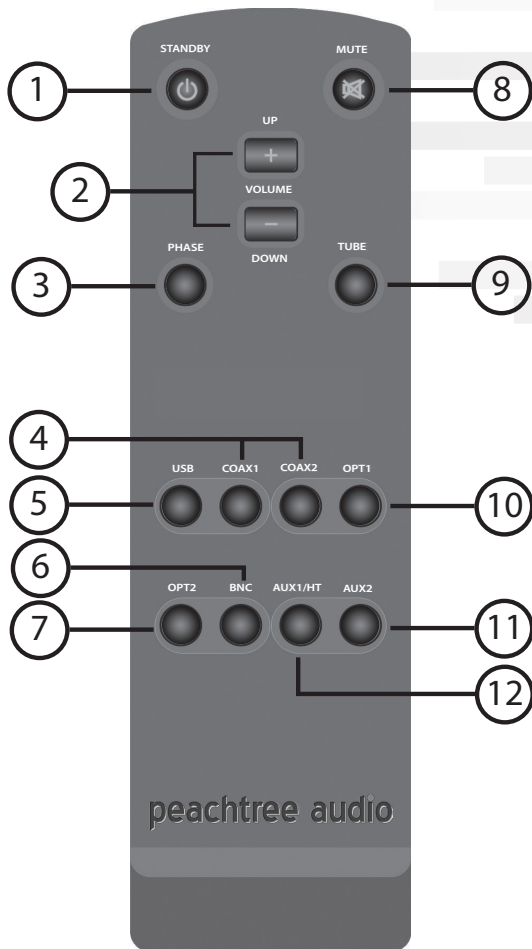

- 1) **On/Standby**: Puts the Grand Integrated in or out of “Standby”.
- 2) **VOL - / VOL +**: Reduce or increase volume level.
- 3) **Phase switch**: When engaged, the Grand Integrated will operate 180 degrees out of phase. An led will appear on the front panel. When it is not engaged, led off, the Grand Integrated is in phase. (See front panel description for more information.)
- 4) **COAX1 & COAX2**: Selects a source connected to a coaxial digital input.
- 5) **USB**: Selects a digital audio source connected to the USB input.
- 6) **BNC**: Selects a digital source connected to the BNC input.
- 7) **OPT2**: Selects a digital source connected to the Optical2 input.
- 8) **Mute**: Mutes or Un-Mutes the output of the Grand Integrated.
- 9) **TUBE**: Switches between solid state or tube-hybrid operation of the Grand Integrated. An amber LED will illuminate in the front panel tube window when in tube-hybrid mode.
- 10) **OPT1**: Selects a digital source connected to the Optical1 input.
- 11) **AUX2**: Selects an analog source connected to the Aux 2 input on the back panel.
- 12) **AUX1**: Selects an analog source connected to the Aux 1 input on the back panel. It will also engage Home Theater bypass mode if it has been selected on the back panel. (See back panel page.)

\*If you inadvertently lose your remote while in “Mute”, you can turn the Grand Integrated off from the back panel for a few seconds, then turn it back on to re-set and use the volume control manually until the remote is found.

At Peachtree Audio we think products should be easy to use, but you need to know a few things before setup. The Grand Integrated's USB digital input accepts music files from your computer's hard drive and plays them back with superb fidelity. See instructions below. Some minor changes may occur with Windows or Apple OS updates, but the basics are the usually the same.

## USB Connections

### PC

- 1) Connect the USB terminal on the Grand Integrated to a USB connection on your computer.
- 2) Your computer will "see" the USB Audio DAC inside the Grand Integrated. You might get a pop-up box noting a new USB connection.
- 3) Right click the speaker icon on the bottom of your screen.
- 4) Select "Audio" tab.
- 5) Using the drop-down box choose the USB dac.
- 6) Click OK.
- 7) You will need to install the included CD software download for 24/192 playback on a PC.

Launch Music Program and play.

### MAC

- 1) Open System Preferences.
- 2) Click on Sound.
- 3) In the Output tab you should see USB Audio DAC (or similar) as one of the choices.
- 4) Select it.

Launch iTunes and enjoy your music.

Once you set up your computer following the above instructions it should recognize the Grand Integrated's USB Audio DAC and default to it. If you unplug the USB connection you may have to repeat some steps; this is not unusual.

## Other useful tips...

For the best sound when listening to music from your computer, set your computer and music program volume controls to maximum and use the Grand Integrated volume knob or remote control as the master volume control.

For critical listening to music from your computer, avoid keeping multiple programs open. It can compromise the sound quality and even cause signal dropouts.

Give the Grand Integrated adequate ventilation as it may get warm.

We'll post articles and other helpful tips on getting the best sound from your computer's music files, your iPod, and your other digital music sources. Visit us at our website:

[www.peachtreeaudio.com](http://www.peachtreeaudio.com)



## Interested in the Green Movement?

The Grand Integrated meets the European RoHS standards for non-hazardous metals.

We will continue to investigate more ways of making our products environmentally friendly. Feel free to email us with your suggestions:

[info@signalpathint.com](mailto:info@signalpathint.com)

<p>The Grand Integrated will not turn on.</p>	<p>Check to be sure that both the power switch on the back panel and the standby switch on the front panel are on. The front panel light should be blue. It is green when in standby.</p>
<p>The Grand Integrated turns on but there is no sound.</p>	<p>Be sure your system is not muted and that the Grand Integrated has been selected. Be sure your digital source is on and playing. Be sure the Grand Integrated's standby button is glowing blue and that your desired input is glowing blue. If the input button is blinking the Grand Integrated is in "mute" mode. Press the mute button on the remote to un-mute the Grand Integrated. Check to be sure your digital cable is properly connected.</p>
<p>The remote control doesn't work.</p>	<p>Please check the batteries by removing the cover on the back of the remote. It is an infrared remote so it needs a clear line of sight to the sensor on the front panel of the Grand Integrated.</p>
<p>You intermittently lose your signal on the USB input.</p>	<p>First, try relaunching your music server program (iTunes, WMP, etc.). If your computer still doesn't recognize the USB DAC unplug the USB cable from the computer and the Grand Integrated, wait a few seconds, then reconnect. These are computer hookups, and sometimes you'll lose a signal just as with your printer or other USB device. You should not have this problem often. We designed the Grand Integrated to remain locked on the USB signal at all times, but signal dropouts are still possible.</p>
<p>You pick up hum and noise on your Grand Integrated from the Computer.</p>	<p>This can require some trial and error diagnostics. If you have music files available on a laptop computer connect it (while on battery power) to the Grand Integrated. If it works properly, with no noise, then the computer in your office is introducing a ground loop into the system. This is not uncommon. However, the Grand Integrated's digital inputs are transformer-coupled to minimize this problem. If a problem persists, please feel free to contact Peachtree Audio.</p>
<p>When you switch from one source to another you get a loud "click" or "pop."</p>	<p>Sometimes this is from static buildup but it should not occur consistently over a long period of time. Contact your dealer or Peachtree Audio if this persists.</p>
<p>The amplifier shuts down but the lights are still on.</p>	<p>The amplifier in the Grand Integrated will shut down if it experiences an unusually large power surge or overheats due to a short, or very loud volumes over a long period of time. This is a protection circuit. Turn down the volume. The amplifier should come back on after a while.</p>

## International Guarantee and Claims Under Warranty

### International Guarantee

The Grand Integrated has a three year Parts and Labor guarantee from the time of purchase. The tubes (valves) have a 6 month guarantee. Units that are covered under this guarantee include Grand Integrateds purchased from an authorized Grand Integrated distributor or dealer.

Peachtree Audio can take no responsibility for defects arising from accident, misuse, abuse, wear and tear, neglect or through unauthorized adjustment and/or repair. The warranty does not cover shipping costs. Visit [www.peachtreeaudio.com](http://www.peachtreeaudio.com) for a copy of the complete warranty.

### Claims Under Warranty

The unit should be packed in its original packing and returned to the dealer from whom it was purchased, or if unavailable, directly to the Grand Integrated distributor.

You should use a suitable carrier. Do Not Send By Postal Service. Peachtree Audio cannot accept responsibility for the Grand Integrated while in transit to the dealer, distributor, or service facility. Please insure your unit against loss or damage while in transit.

In the unlikely event that you experience a failure with your Grand Integrated, please call for a return authorization number before returning products for service. Any Grand Integrated received without an RA # will be refused. You may also wish to route your repair through your dealer, which we encourage.

Call 704-391-9337 for a return authorization number and additional information on where and how to return your unit for service.

Main office (not service):

Peachtree Audio  
2045 120th Avenue NE  
Bellevue WA 98005

[www.peachtreeaudio.com](http://www.peachtreeaudio.com)

- Fixed line-level RCA stereo output: 2V rms
- Variable RCA stereo output: 8V rms / 11.2V peak
- Line level output impedance: 448 ohms
- Single ended RCA preamp output impedance: 448 ohms
- S/N at the fixed analog output 107db
- S/N at the variable analog output 104db
- Jitter measured at the master clock < 3.0ps
- Power supply: 69,000uf of filtering
- Volume control: Dual Mono adjustable gain volume control with 0.02db CH/CH tracking
- Stereo separation. 96db
- Defeatable 80Hz highpass
- Selectable Home Theater Bypass input
- Independent discrete outputs
- 2 X 400W, 8ohms, 20Hz-20Khz, less than 0.5% THD
- Maximum power consumption: 1000W
- Dimensions: 4.8"H X 17.5"W X 16.5"D
- Weight: 26 lbs.



# peachtree audio



# Grand Integrated