



# SCREENLOGIC2<sup>®</sup> INTERFACE



## INSTALLATION AND USER'S GUIDE

IMPORTANT SAFETY INSTRUCTIONS  
READ AND FOLLOW ALL INSTRUCTIONS  
SAVE THESE INSTRUCTIONS

# Contents

|   |           |
|---|-----------|
| <b>Introduction .....</b>   | <b>1</b>  |
| Introduction .....  | 1         |
| EasyTouch and IntelliTouch Interfaces .....                                   | 2         |
| ScreenLogic2 in your home .....   | 3         |
| ScreenLogic2 Interface Kits .....   | 3         |
| <b>Section 1: Installation .....</b>  | <b>4</b>  |
| Before You Begin .....  | 4         |
| Tools Required .....  | 4         |
| Connection Steps Summary .....  | 4         |
| ScreenLogic2 Location Requirements .....                                      | 5         |
| Less walls and ceilings equals better wireless reception .....                | 5         |
| Cable Distance Limits .....   | 6         |
| Recommended Wireless Router and Protocol adapter Location .....               | 6         |
| Wireless router and Protocol adapter with existing Indoor Control Panel ..... | 7         |
| Connecting without Broadband Internet Access .....                            | 8         |
| Connecting to your Home Network with Broadband Access .....                   | 9         |
| Connecting to an existing home network .....                                  | 9         |
| Connecting to your Home Network with Broadband Access .....                   | 10        |
| Connect to the Protocol Adapter to IntelliTouch or EasyTouch .....            | 11        |
| Connect to the Protocol Adapter to the Load Center Circuit Board .....        | 12        |
| Start up the IntelliTouch ScreenLogic2 System for the first time .....        | 14        |
| To start up the system .....  | 14        |
| <b>Section 2: Configuring the ScreenLogic2 Interface .....</b>                | <b>15</b> |
| Accessing IntelliTouch ScreenLogic Configuration Program .....                | 15        |
| Installing ScreenLogic Software .....   | 15        |
| Start ScreenLogic Program .....   | 16        |
| Exit ScreenLogic Program .....  | 16        |
| Compatibility with IntelliTouch and EasyTouch Systems .....                   | 16        |
| ScreenLogic2 Configuration and Maintenance Screen .....                       | 17        |
| <b>General Settings (Step 1 of 5) .....</b>                                   | <b>17</b> |
| Changing the Display to Show Fahrenheit to Celsius .....                      | 19        |
| Calibrating Temperature Sensors .....   | 19        |

## Contents (Continued)

|  |               |
|--|---------------|
| <b>Setup Circuits (Step 2 of 5)</b> .....                                | <b>20</b>     |
| Special Lights Button .....  | 21            |
| Feature Circuit Configuration Button .....                               | 21            |
| Feature Macro Circuits Overview .....                                    | 22            |
| Freeze Protection .....  | 22            |
| Assign a Circuit Name and Function .....                                 | 23            |
| Circuit Functions .....  | 24            |
| Circuit Names .....  | 25            |
| Creating a Feature Circuit Macro (IntelliTouch only) .....               | 26            |
| Creating Custom Names for Auxiliary Circuits .....                       | 27            |
| Display a Circuit Function Button on the Main Screen .....               | 27            |
| IntelliTouch Indoor Control Panel Circuit Names .....                    | 27            |
| <br><b>Configure Other Equipment (Step 3 of 5)</b> .....                 | <br><b>28</b> |
| Configuring Valve Actuators (Controlled by AUX or Feature Circuit) ..... | 29            |
| Configuring Valve Actuators .....  | 30            |
| <br><b>Configuring IntelliFlo (Step 4 of 5)</b> .....                    | <br><b>31</b> |
| Setting up Additional Equipment .....                                    | 35            |
| Setting up a Two-Speed Pump .....  | 35            |
| Setup Solar Equipment and Heat pump options .....                        | 36            |
| Set a Cool-Down Cycle for the Heater .....                               | 36            |
| Enable Manual Spa Heat Control .....                                     | 37            |
| Chlorine Generator .....   | 37            |
| IntelliChem Water Chemistry Controller .....                             | 37            |
| Activate the Chlorinator Control Interface .....                         | 37            |
| <br><b>Configure 10-Button Spa-Side Remote (Step 5 of 5)</b> .....       | <br><b>38</b> |
| Configure 10-Button (SpaCommand, iS10, QuickTouch Spa-Side Remote) ..... | 39            |
| <br><b>Section 3: Using the ScreenLogic2 Interface</b> .....             | <br><b>40</b> |
| Home Screen .....  | 40            |
| Main Screen Description .....  | 41            |
| Configuring Pool and Spa Heating System Options .....                    | 43            |
| Change the Pool and Spa Temperature .....                                | 44            |
| Changing Pool Heat Settings .....  | 44            |
| Changing Spa Heat Settings .....   | 44            |
| Main Lights Screen .....   | 44            |
| Color Lights Tab .....   | 45            |
| Dim Lights .....   | 46            |

## Contents (Continued)

|   |           |
|---|-----------|
| Special Lighting Features .....                           | 47        |
| Lights Screen: Configure Set Colors Tab (Color Set) ..... | 48        |
| Color Set Lighting Feature .....                          | 50        |
| Set up Swimming Colors (Color Swim) .....                 | 50        |
| Color Sync .....  | 51        |
| Switching Lights All ON/All OFF .....                     | 51        |
| Lights Screen: IntelliBrite Lights .....                  | 52        |
| Color light show and fixed color buttons .....            | 52        |
| Save and Recall buttons .....                             | 52        |
| Schedule Screen .....                                     | 53        |
| Schedule Feature .....                                    | 54        |
| Schedule: Run Once Screen .....                           | 55        |
| Run-Once Timer .....                                      | 56        |
| Schedule: Egg Timer Screen .....                          | 57        |
| Setting the Egg Timer (Count Down) .....                  | 58        |
| History Screens .....                                     | 59        |
| Delays & Alerts Screen .....                              | 60        |
| System Error Messages .....                               | 61        |
| System Delay Cancel Feature .....                         | 61        |
| Enable/Disable Spa-Side Remotes .....                     | 61        |
| Chlorinator Screens .....                                 | 62        |
| IntelliChlem Screen .....                                 | 63        |
| Pumps: IntelliFlo Status and Control VF Screen .....      | 64        |
| Pumps: IntelliFlo VS Status and Control Screen .....      | 65        |
| <b>Section 4: FAQs and Troubleshooting .....</b>          | <b>67</b> |
| IntelliFlo VF Alarms and Warnings .....                   | 68        |
| IntelliFlo VS Alarms and Warnings .....                   | 69        |
| Suction Blockage .....                                    | 69        |
| Connecting remotely to your system .....                  | 70        |
| <b>Glossary .....</b>                                     | <b>71</b> |

## IMPORTANT WARNING AND SAFETY INSTRUCTIONS



### Important Notice:

**Attention Installer:** This manual contains important information about the installation, operation and safe use of this product. This manual should be given to the owner and/or operator of this equipment.

**⚠ WARNING** - Before installing this product, read and follow all warning notices and instructions which are included. Failure to follow safety warnings and instructions can result in severe injury, death, or property damage. Call (800) 831-7133 for additional free copies of these instructions.

**⚠ CAUTION - Danger of explosion if battery is incorrectly replaced.** Replace only with the same type recommended by the manufacturer. Dispose of used batteries according to the manufacturer's instructions.

Rechargeable Lithium-ion battery disposal

**Unwanted lithium ion battery packs may be returned to your local recycling center or the battery manufacturer for disposal.**

### CE (EU) Declaration of Conformity

This product conforms to the essential protection requirements of the European Council Directive 89/336/EEC that relates to electromagnetic compatibility, EN55022:1998, Class B; and EN61000- 3-2, 3-3, 4-2, 4-3, 4-4, 4-5, 4-6, 4-8, and 4-11.

### Modifications

The FCC requires the user to be notified that any changes or modifications made to this device that are not expressly approved by DT Research can invalidate FCC approval.

**CAUTION:** Danger of explosion if battery is incorrectly replaced.

- Replace only with the same type recommended by the manufacturer.
- Dispose of used batteries according to the manufacturer's instructions.
- Rechargeable Lithium-ion battery disposal
- Unwanted lithium ion battery packs may be returned to the battery manufacturer for disposal.
- Enclosure: Dismantling or opening the device enclosure or case will void warranty and may possibly cause electric shock. Avoid exposure to water.

## IMPORTANT WARNING AND SAFETY INSTRUCTIONS

**⚠ FCC Regulatory Safety Notice** - The wireless products devices have been tested and found to comply with the limits for a Class B digital device, pursuant to Part 15 of the FCC Rules. These limits are designed to provide reasonable protection against harmful interference in a residential installation. These devices generates, uses and can radiate radio frequency energy and, if not installed and used in accordance with the instructions, may cause harmful interference to radio communications. However, there is no guarantee that interference will not occur in a particular installation. If this equipment does cause harmful interference to radio or television reception, which can be determined by turning the equipment off and on, the user is encouraged to try to correct the interference by one or more of the following measures:

- Reorient or relocate the receiving antenna.
- Increase the separation between the equipment and receiver.
- Connect the equipment into an outlet on a circuit different from that to which the receiver is connected.
- Consult the dealer or an experienced radio/TV technician for help.
- Modifications not expressly approved by the party responsible for FCC compliance could void the user's authority to operate the equipment.

## About this User's Guide

This manual describes the how to set up and use the ScreenLogic2® Control System, including how to configure your IntelliTouch® Control System using the Configurator utility, and how to use the ScreenLogic system program to control basic everyday pool and spa operations to advanced setup functions that only need to be performed once.

This manual includes the following sections:

- **Introduction (page 1):** IntelliTouch system description.
- **Installation (page 11):** How to install the Protocol adapter. Also, location recommendations.
- **Configuring ScreenLogic2 (page 15):** Description of each Configurator utility dialog. Each dialog description is followed by more detailed information and examples of the features.
- **Using your ScreenLogic2 Interface (page 40):** Description of ScreenLogic2 user screens. Each screen description is followed by more detailed information about how to use ScreenLogic features.
- **FAQs and Troubleshooting (page 67):** Frequently asked questions about using ScreenLogic2 interface. Also includes troubleshooting information.
- **Glossary (page 71):** Glossary of terms used in this manual.

## Technical Support

**Sanford, North Carolina** (8 A.M. to 5 P.M.)

**Moorpark, California** (8 A.M. to 5 P.M.)

**Phone:** (800) 831-7133

**Fax:** (800) 284-4151

Web site: visit [www.pentairpool.com](http://www.pentairpool.com) and [www.starite.com](http://www.starite.com)

## Related IntelliTouch® and EasyTouch® Control System Manuals

|   |              |
|---|--------------|
| EasyTouch Control System User's Guide   | (P/N 521044) |
| IntelliTouch Control System User's Guide  | (P/N 521075) |
| IntelliTouch Control System Personality Kit User's Guide                            | (P/N 521074) |
| EasyTouch and IntelliTouch Control System Load Center and Power Center User's Guide | (P/N 521139) |

# Contents

|  |           |
|--|-----------|
| <b>Introduction .....</b>  | <b>1</b>  |
| Introduction .....   | 1         |
| EasyTouch and IntelliTouch Interfaces .....  | 2         |
| ScreenLogic2 in your home .....  | 3         |
| ScreenLogic2 Interface Kits .....  | 3         |
| <b>Section 1: Installation .....</b>   | <b>4</b>  |
| Before You Begin .....   | 4         |
| Tools Required .....   | 4         |
| Connection Steps Summary .....   | 4         |
| ScreenLogic2 Location Requirements .....   | 5         |
| Less walls and ceilings equals better wireless reception .....                     | 5         |
| Cable Distance Limits .....  | 6         |
| Recommended Wireless Router and Protocol adapter Location .....                    | 6         |
| Wireless router and Protocol adapter with existing Indoor Control Panel .....      | 7         |
| Connecting without Broadband Internet Access .....                                 | 8         |
| Connecting to your Home Network with Broadband Access .....                        | 9         |
| Connecting to an existing home network .....                                       | 9         |
| Connecting to your Home Network with Broadband Access .....                        | 10        |
| Connect to the Protocol Adapter to IntelliTouch or EasyTouch .....                 | 11        |
| Connect to the Protocol Adapter to the Load Center Circuit Board .....             | 12        |
| Start up the IntelliTouch ScreenLogic2 System for the first time .....             | 14        |
| To start up the system .....   | 14        |
| <b>Section 2: Configuring the ScreenLogic2 Interface .....</b>                     | <b>15</b> |
| Accessing IntelliTouch ScreenLogic Configuration Program .....                     | 15        |
| Installing IntelliTouch ScreenLogic Software on a PC or Laptop (iTC15 Kit only) .. | 15        |
| Start ScreenLogic Program .....  | 16        |
| Exit ScreenLogic Program .....   | 16        |
| Compatibility with IntelliTouch and EasyTouch Systems .....                        | 16        |
| ScreenLogic2 Configuration and Maintenance Screen .....                            | 17        |
| <b>General Settings (Step 1 of 5) .....</b>  | <b>17</b> |
| Changing the Display to Show Fahrenheit to Celsius .....                           | 19        |
| Calibrating Temperature Sensors .....  | 19        |



## Contents (Continued)

|  |               |
|--|---------------|
| <b>Setup Circuits (Step 2 of 5)</b> .....                                | <b>20</b>     |
| Special Lights Button .....  | 21            |
| Feature Circuit Configuration Button .....                               | 21            |
| Feature Macro Circuits Overview .....                                    | 22            |
| Freeze Protection .....  | 22            |
| Assign a Circuit Name and Function .....                                 | 23            |
| Circuit Functions .....  | 24            |
| Circuit Names .....  | 25            |
| Creating a Feature Circuit Macro (IntelliTouch only) .....               | 26            |
| Creating Custom Names for Auxiliary Circuits .....                       | 27            |
| Display a Circuit Function Button on the Main Screen .....               | 27            |
| IntelliTouch Indoor Control Panel Circuit Names .....                    | 27            |
| <br><b>Configure Other Equipment (Step 3 of 5)</b> .....                 | <br><b>28</b> |
| Configuring Valve Actuators (Controlled by AUX or Feature Circuit) ..... | 29            |
| Configuring Valve Actuators .....  | 30            |
| <br><b>Configuring IntelliFlo (Step 4 of 5)</b> .....                    | <br><b>31</b> |
| Setting up Additional Equipment .....                                    | 35            |
| Setting up a Two-Speed Pump .....  | 35            |
| Setup Solar Equipment and Heat pump options .....                        | 36            |
| Set a Cool-Down Cycle for the Heater .....                               | 36            |
| Enable Manual Spa Heat Control .....                                     | 37            |
| Chlorine Generator .....   | 37            |
| IntelliChem Water Chemistry Controller .....                             | 37            |
| Activate the Chlorinator Control Interface .....                         | 37            |
| <br><b>Configure 10-Button Spa-Side Remote (Step 5 of 5)</b> .....       | <br><b>38</b> |
| Configure 10-Button (SpaCommand, iS10, QuickTouch Spa-Side Remote) ..... | 39            |
| <br><b>Section 3: Using the ScreenLogic2 Interface</b> .....             | <br><b>40</b> |
| Home Screen .....  | 40            |
| Main Screen Description .....  | 41            |
| Configuring Pool and Spa Heating System Options .....                    | 43            |
| Change the Pool and Spa Temperature .....                                | 44            |
| Changing Pool Heat Settings .....  | 44            |
| Changing Spa Heat Settings .....   | 44            |
| Main Lights Screen .....   | 44            |
| Color Lights Tab .....   | 45            |
| Dim Lights .....   | 46            |

## Contents (Continued)

|   |           |
|---|-----------|
| Special Lighting Features .....                           | 47        |
| Lights Screen: Configure Set Colors Tab (Color Set) ..... | 48        |
| Color Set Lighting Feature .....                          | 50        |
| Set up Swimming Colors (Color Swim) .....                 | 50        |
| Color Sync .....  | 51        |
| Switching Lights All ON/All OFF .....                     | 51        |
| Lights Screen: IntelliBrite Lights .....                  | 52        |
| Color light show and fixed color buttons .....            | 52        |
| Save and Recall buttons .....                             | 52        |
| Schedule Screen .....                                     | 53        |
| Schedule Feature .....                                    | 54        |
| Schedule: Run Once Screen .....                           | 55        |
| Run-Once Timer .....                                      | 56        |
| Schedule: Egg Timer Screen .....                          | 57        |
| Setting the Egg Timer (Count Down) .....                  | 58        |
| History Screens .....                                     | 59        |
| Delays & Alerts Screen .....                              | 60        |
| System Error Messages .....                               | 61        |
| System Delay Cancel Feature .....                         | 61        |
| Enable/Disable Spa-Side Remotes .....                     | 61        |
| Chlorinator Screens .....                                 | 62        |
| IntelliChlem Screen .....                                 | 63        |
| Pumps: IntelliFlo Status and Control VF Screen .....      | 64        |
| Pumps: IntelliFlo VS Status and Control Screen .....      | 65        |
| <b>Section 4: FAQs and Troubleshooting .....</b>          | <b>67</b> |
| IntelliFlo VF Alarms and Warnings .....                   | 68        |
| IntelliFlo VS Alarms and Warnings .....                   | 69        |
| Suction Blockage .....                                    | 69        |
| Connecting remotely to your system .....                  | 70        |
| <b>Glossary .....</b>                                     | <b>71</b> |

## IMPORTANT WARNING AND SAFETY INSTRUCTIONS



### Important Notice:

**Attention Installer:** This manual contains important information about the installation, operation and safe use of this product. This manual should be given to the owner and/or operator of this equipment.

**⚠ WARNING** - Before installing this product, read and follow all warning notices and instructions which are included. Failure to follow safety warnings and instructions can result in severe injury, death, or property damage. Call (800) 831-7133 for additional free copies of these instructions.

**⚠ CAUTION - Danger of explosion if battery is incorrectly replaced.** Replace only with the same type recommended by the manufacturer. Dispose of used batteries according to the manufacturer's instructions.

Rechargeable Lithium-ion battery disposal

**Unwanted lithium ion battery packs may be returned to your local recycling center or the battery manufacturer for disposal.**

### CE (EU) Declaration of Conformity

This product conforms to the essential protection requirements of the European Council Directive 89/336/EEC that relates to electromagnetic compatibility, EN55022:1998, Class B; and EN61000- 3-2, 3-3, 4-2, 4-3, 4-4, 4-5, 4-6, 4-8, and 4-11.

### Modifications

The FCC requires the user to be notified that any changes or modifications made to this device that are not expressly approved by DT Research can invalidate FCC approval.

**CAUTION:** Danger of explosion if battery is incorrectly replaced.

- Replace only with the same type recommended by the manufacturer.
- Dispose of used batteries according to the manufacturer's instructions.
- Rechargeable Lithium-ion battery disposal
- Unwanted lithium ion battery packs may be returned to the battery manufacturer for disposal.
- Enclosure: Dismantling or opening the device enclosure or case will void warranty and may possibly cause electric shock. Avoid exposure to water.

## IMPORTANT WARNING AND SAFETY INSTRUCTIONS

**⚠ FCC Regulatory Safety Notice** - The wireless products devices have been tested and found to comply with the limits for a Class B digital device, pursuant to Part 15 of the FCC Rules. These limits are designed to provide reasonable protection against harmful interference in a residential installation. These devices generates, uses and can radiate radio frequency energy and, if not installed and used in accordance with the instructions, may cause harmful interference to radio communications. However, there is no guarantee that interference will not occur in a particular installation. If this equipment does cause harmful interference to radio or television reception, which can be determined by turning the equipment off and on, the user is encouraged to try to correct the interference by one or more of the following measures:

- Reorient or relocate the receiving antenna.
- Increase the separation between the equipment and receiver.
- Connect the equipment into an outlet on a circuit different from that to which the receiver is connected.
- Consult the dealer or an experienced radio/TV technician for help.
- Modifications not expressly approved by the party responsible for FCC compliance could void the user's authority to operate the equipment.

## About this User's Guide

This manual describes the how to set up and use the ScreenLogic2® Control System, including how to configure your IntelliTouch® Control System using the Configurator utility, and how to use the ScreenLogic system program to control basic everyday pool and spa operations to advanced setup functions that only need to be performed once.

This manual includes the following sections:

- **Introduction (page 1):** IntelliTouch system description.
- **Installation (page 11):** How to install the Protocol adapter. Also, location recommendations.
- **Configuring ScreenLogic2 (page 15):** Description of each Configurator utility dialog. Each dialog description is followed by more detailed information and examples of the features.
- **Using your ScreenLogic2 Interface (page 40):** Description of ScreenLogic2 user screens. Each screen description is followed by more detailed information about how to use ScreenLogic features.
- **FAQs and Troubleshooting (page 67):** Frequently asked questions about using ScreenLogic2 interface. Also includes troubleshooting information.
- **Glossary (page 71):** Glossary of terms used in this manual.

## Technical Support

**Sanford, North Carolina** (8 A.M. to 5 P.M.)

**Moorpark, California** (8 A.M. to 5 P.M.)

**Phone:** (800) 831-7133

**Fax:** (800) 284-4151

Web site: visit [www.pentairpool.com](http://www.pentairpool.com) and [www.starite.com](http://www.starite.com)

## Related IntelliTouch® and EasyTouch® Control System Manuals

|   |              |
|---|--------------|
| EasyTouch Control System User's Guide   | (P/N 521044) |
| IntelliTouch Control System User's Guide  | (P/N 521075) |
| IntelliTouch Control System Personality Kit User's Guide                            | (P/N 521074) |
| EasyTouch and IntelliTouch Control System Load Center and Power Center User's Guide | (P/N 521139) |

## Introduction

Welcome! Your Pentair the ScreenLogic2 Interface® will change the way you view pool and spa controls. the ScreenLogic2 Interface supports IntelliTouch® and EasyTouch® Control Systems. This innovation in pool and spa automation offers complete freedom for you while having full automation control over your pool, spa, lights, heater, cleaners and much more. You can now schedule multiple start and stop times to control your lights, heater, spa jets, and filter pumps. The ScreenLogic2 Interface historical data feature monitors energy use for your pool, spa and lighting equipment and also records pool, spa, and air temperatures. This historical data provides a convenient way to help you conserve energy. Using the wireless Apple Watch®, Andriod™ interface for phone or tablet, iPhone®, or iPad® you can now control your pool and spa from anywhere inside or outside your home. An in-wall Touch Screen and a program for your PC are also available. the ScreenLogic2 Interface is a scalable system that can be upgraded to a completely integrated home automation solution including audio, security, climate, irrigation and more.

This manual describes how to install, configure, and operate the ScreenLogic2 Interface.

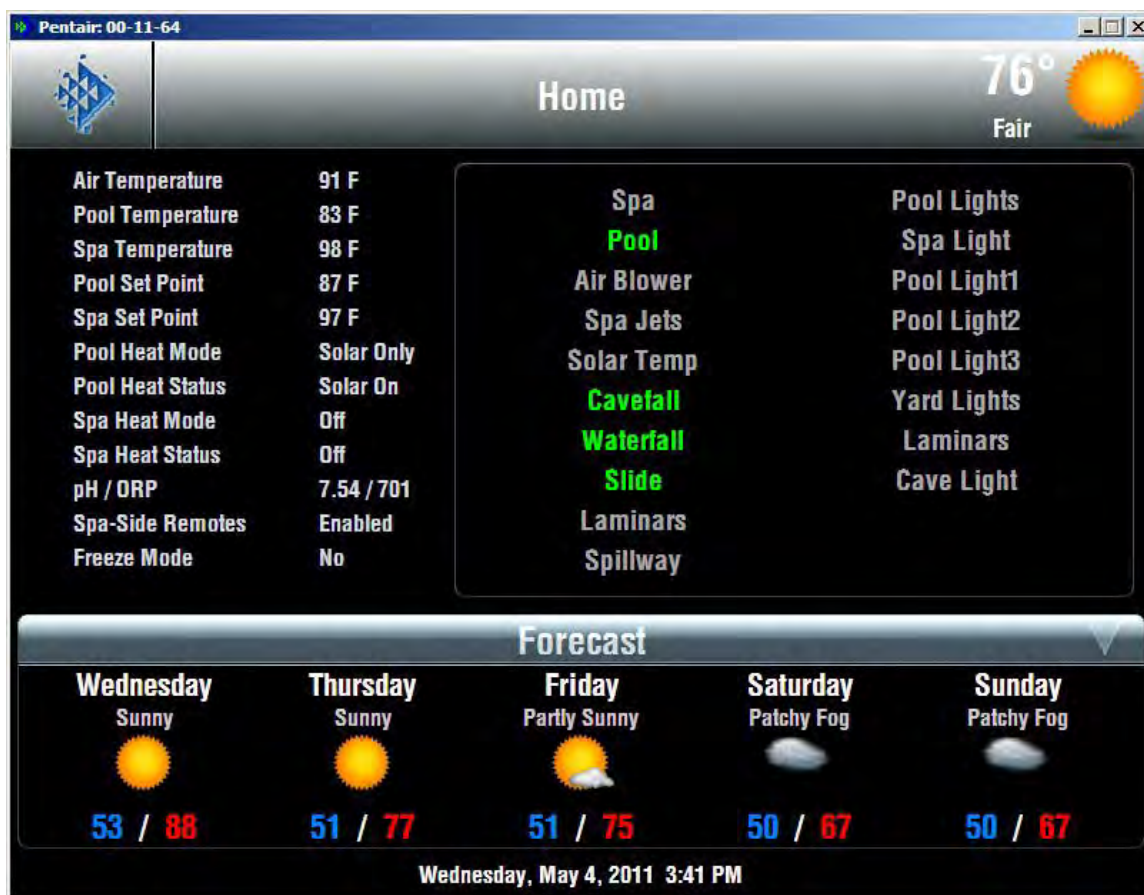

the ScreenLogic2 Interface Main Screen

## EasyTouch® and IntelliTouch® Control System Interfaces

Pool and Spa owners can choose one or more of the following interface options to control the IntelliTouch® Control System throughout their home.

- **iPhone®, iPad® Touch Interface (P/N 522104)** – Includes Protocol Interface Adapter and wireless link that connects to existing Desktop or Laptop PC. This allows control of the IntelliTouch® and EasyTouch® Control Systems via PC (requires PC with an Ethernet connection, and Windows® XP operating system or later).

### iPhone®, iPad® and iPod® Touch

The ScreenLogic2® Interface iOS app gives you complete control over your EasyTouch® and IntelliTouch® Control Systems. Controlling pool and spa operations couldn't be easier...or more convenient. Once the software is installed, you can control everything from pool and spa temperatures, jets, lighting, water features, remote video monitoring, and more...right from an iPhone® or iPad® touch. Imagine being able to:

- Easily turn on spa and adjust the desired temperature on the way home from work.
- Control all circuits (waterfalls, pool lights, fountains, and more) and review history of temperature, pool/spa, heater, and light operation.

The new software is available free at the [Apple App Store](#). Just browse the App Store on your Apple® device and type in the search term “Pentair” to quickly find.

For new EasyTouch and IntelliTouch Control Systems purchasers, the easiest and most cost-effective way to add control access via the Apple Watch®, Andriod™ interface for phone or tablet, iPhone, iPad and iPod touch is to purchase a the ScreenLogic2 Interface PC interface kit (Part # 522104).





## ScreenLogic2® Interface in your home

- 1 **Personal Computer (PC):** Existing home owner's PC or Laptop. Connects to a wireless router and the ScreenLogic2 Interface Protocol adapter for control of IntelliTouch® and EasyTouch® Control Systems. Requires a PC/Laptop (Windows® 7, Vista or XP or later) with Ethernet/RJ45 adapter installed.
- 2 **iPad®, iPadTouch® or iPhone®:** Enables you to control your pool and spa features using the ScreenLogic2 Interface.
- 3 **Indoor Control Panel:** This control panel for the IntelliTouch and EasyTouch control system. Consists of a backlit LCD and connects into the Load Center for control of the IntelliTouch or EasyTouch control system.
- 4 **MobileTouch® or EasyTouch Wireless Remote:** This wireless controller has a backlit LCD. Receives and transmits commands via the Transceiver antenna located at the Load Center.
- 5 **Wireless router:** Connects to the PC or Laptop via Ethernet connection to the Protocol adapter.
- 6 **Protocol adapter:** Connects to wireless router via Ethernet connection and to Personality board (Load/Power Center) via a four-wire 22-AWG cable.
- 7 **IntelliTouch or EasyTouch Control System Load Center or Power Center.** The main control center. Includes the Outdoor Control Panel that controls pump, heater, and light relays. Receives commands via Protocol adapter, and wireless and wired control panels connected to the Personality board.
- 8 **MobileTouch and IntelliTouch Control System Transceiver antenna:** This antenna sends and receives commands to and from the MobileTouch® Wireless Controller.

*Note: For the ScreenLogic2 Interface connection details, refer to page 5 and 14.*

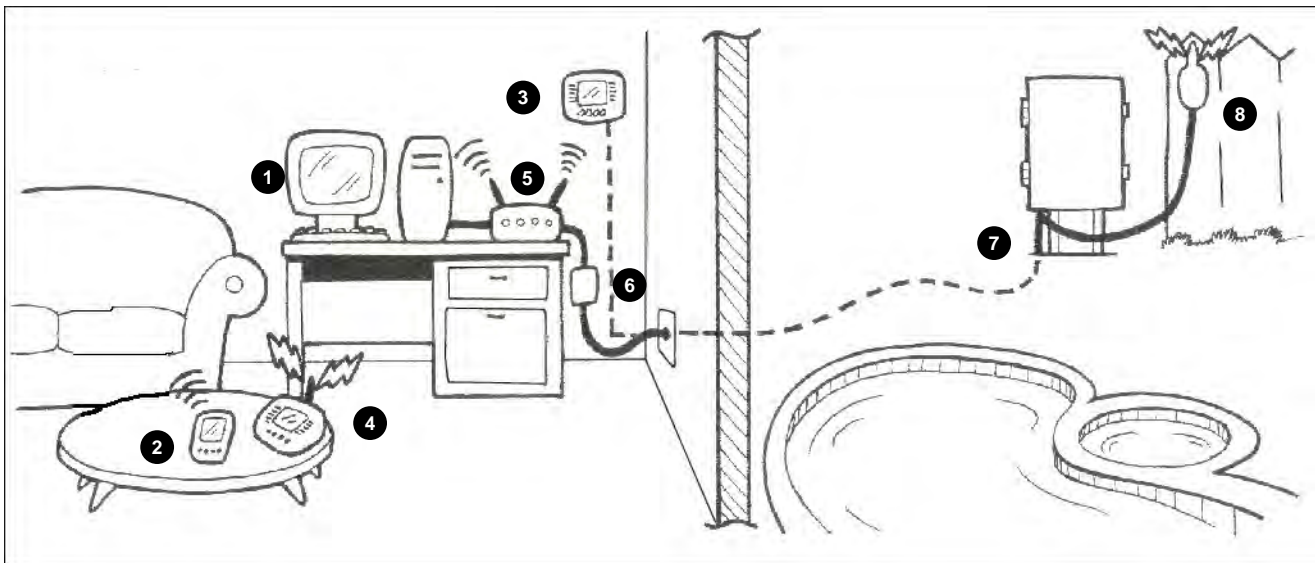

## ScreenLogic2® Interface Kits

The following items are included in your the ScreenLogic2 Interface Kit. As you unpack your the ScreenLogic2 Interface Kit, please check to make sure that you received the items listed below. If any item is missing or damaged, contact your authorized dealer, or contact Technical Support (see page viii).

### ScreenLogic Wireless Bundle (P/N 522104)

- Protocol Interface Adapter for use with existing Desktop or Laptop PC, iPhone, iPodTouch, or iPad
- The ScreenLogic2 Interface User's Guide
- Wireless link



# Installation

---

## Section 1

### Before You Begin

#### Tools Required

- Wire stripping tool (for stripping cable wires)
- Ethernet connector tool (for custom Ethernet cabling)

#### Connection Steps Summary

Before connecting the ScreenLogic2 Interface, the IntelliTouch or EasyTouch Load Center and Personality Kit should already be installed. The recommended the ScreenLogic2 Interface installation steps are:

**Switch power off to the EasyTouch or IntelliTouch Control System Load Center:** Before connecting cables to the ScreenLogic2 Interface Protocol adapter, switch off the power source to the Load Center.

**Review the location requirements before installing the Protocol adapter (pages 5 - 7).**

**Connect the ScreenLogic2 Interface Protocol Adapter (pages 8 - 13):** Connect a 22-gauge four-wire cable to the Protocol adapter and to one of the available COM ports on the circuit board located in the Load Center. If both ports are in use, you can wire into the COM port connection block.

**Start up the ScreenLogic2 Interface System (page 14):** Verify cable connections. Power-up the Load Center.

## ScreenLogic2® Interface Location Requirements

The ScreenLogic2 Interface Protocol adapter must be located inside in a dry environment, preferably near the home owner's DSL/Cable modem.

To ensure optimum wireless connection, placement of the existing wireless router inside the home is important. Ideally, the wireless router should be positioned in the room nearest to the pool and spa location or close to where the iPad, iPod or iPhone will be primarily used.

### Less walls and ceilings equals better wireless reception

Your existing wireless router allows the iPad, iPod, iPhone or a wireless laptop to access the ScreenLogic2 Interface from anywhere in and around your home up to approximately 150 feet from the wireless router. However, keep in mind that range is limited by the number of walls, ceilings, or other objects that the wireless signals must pass through. Typical ranges vary depending on the types of materials and background RF noise in your home. The following information can help maximize the wireless transmission and reception range:

1. Keep the number of walls and ceilings between the wireless router and the iPad, iPod or iPhone to a minimum - Each wall or ceiling can rob your wireless router of 3-90 ft. of range. Position your wireless router so that the number of walls or ceilings are minimized.
2. Consider the direct line between your wireless router and iPad, iPod or iPhone area of operation. A wall that is 1.5 feet thick, at a 45 degree angle, appears to be almost 3 feet thick to the wireless signal. At a two-degree angle it looks over 42 feet thick! Try to make sure that the wireless router is positioned so that the signal travels straight through a wall or ceiling for better reception.
3. Building materials make a difference - A solid metal door or aluminum studs may have a negative effect on range. Try to position the wireless router so that the signal passes through drywall or open doorways and not other materials.
4. Keep your wireless router away (at least 3-6 feet) from electrical devices that generate RF noise like microwaves, monitors, electric motors, UPS units, etc.
5. If you are using 2.4 GHz cordless phones or X-10 (wireless products such as ceiling fans, lights, and home security systems), your wireless connection might degrade dramatically or drop completely. Anything using the 2.4 GHz frequency could interfere with your wireless network.
6. For the average sized home, range should not be a problem. If you experience low or no signal strength in areas of your home that you wish to access, consider repositioning the wireless router.

### IMPORTANT NOTE ABOUT MULTIPLE WIRELESS CONTROLLERS

**IF YOU ARE USING MULTIPLE WIRELESS CONTROLLER SUCH AS:** MobileTouch® or EasyTouch® Control System Wireless Remote, iS4 QuickTouch® Wireless Controller, be sure the Transceiver for each of these controllers are located at least 6 ft. apart for each other. This will avoid digital interference and ensure better wireless reception.

## Location Requirements (continued)

### Cable Distance Limits

Depending upon your location requirements, you may choose to have a long Ethernet cable run and a short four-wire cable run or vice-versa. The recommended cable limits are:

- Ethernet cable distance limit = 300 feet
- Four-wire cable distance limit = 1500 feet

### Recommended Wireless Router and Protocol adapter Location

**Note:** A first floor installation location is recommended to maximize the wireless signal strength. However, if an upstairs installation is the only option, for the best reception it is recommended that the wireless router be located on the floor directly above where the wireless device will be primarily used.

Advantages:

- Good wireless coverage to back of home and pool/spa area
- Minimal Protocol adapter cable wiring

Disadvantage:

- Requires Ethernet cable connection to existing wired or wireless router connected to DSL or Cable modem.  
Note: Only required if you plan to access the Internet. Use of the ScreenLogic2 Interface does not require an Internet connection.
- Requires Serial cable run from Protocol adapter to Load Center

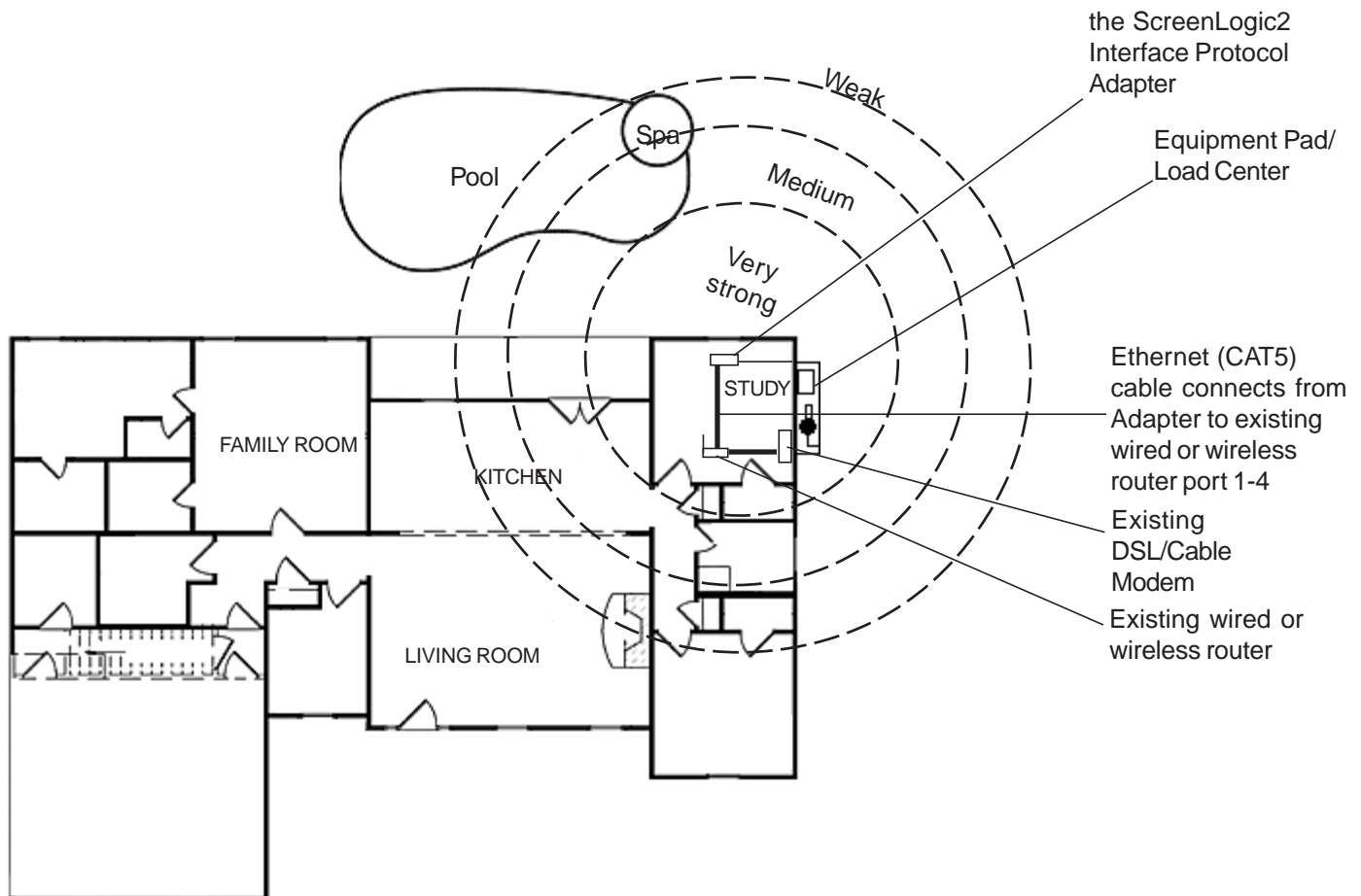

## Wireless router and Protocol adapter with existing Indoor Control Panel (option)

In some cases the homeowner will already have an existing IntelliTouch® or EasyTouch® Control System Indoor Control Panel. The four-wire conductor cable used to connect to the ScreenLogic2 Interface Protocol adapter can tap in the Indoor Control Panel's four-wire connector or cable.

### Advantage:

- Can tap into existing the IntelliTouch or EasyTouch Control System Indoor Control Panel connector or cable
- Minimal Protocol adapter serial cable wiring
- Good wireless coverage to back of home and pool/spa area

### Disadvantage:

- Requires Ethernet cable connection to existing wired or wireless router connected to DSL or Cable modem. This is only required if you plan to access the Internet. Use of the ScreenLogic®2 Interface does not require an Internet connection.

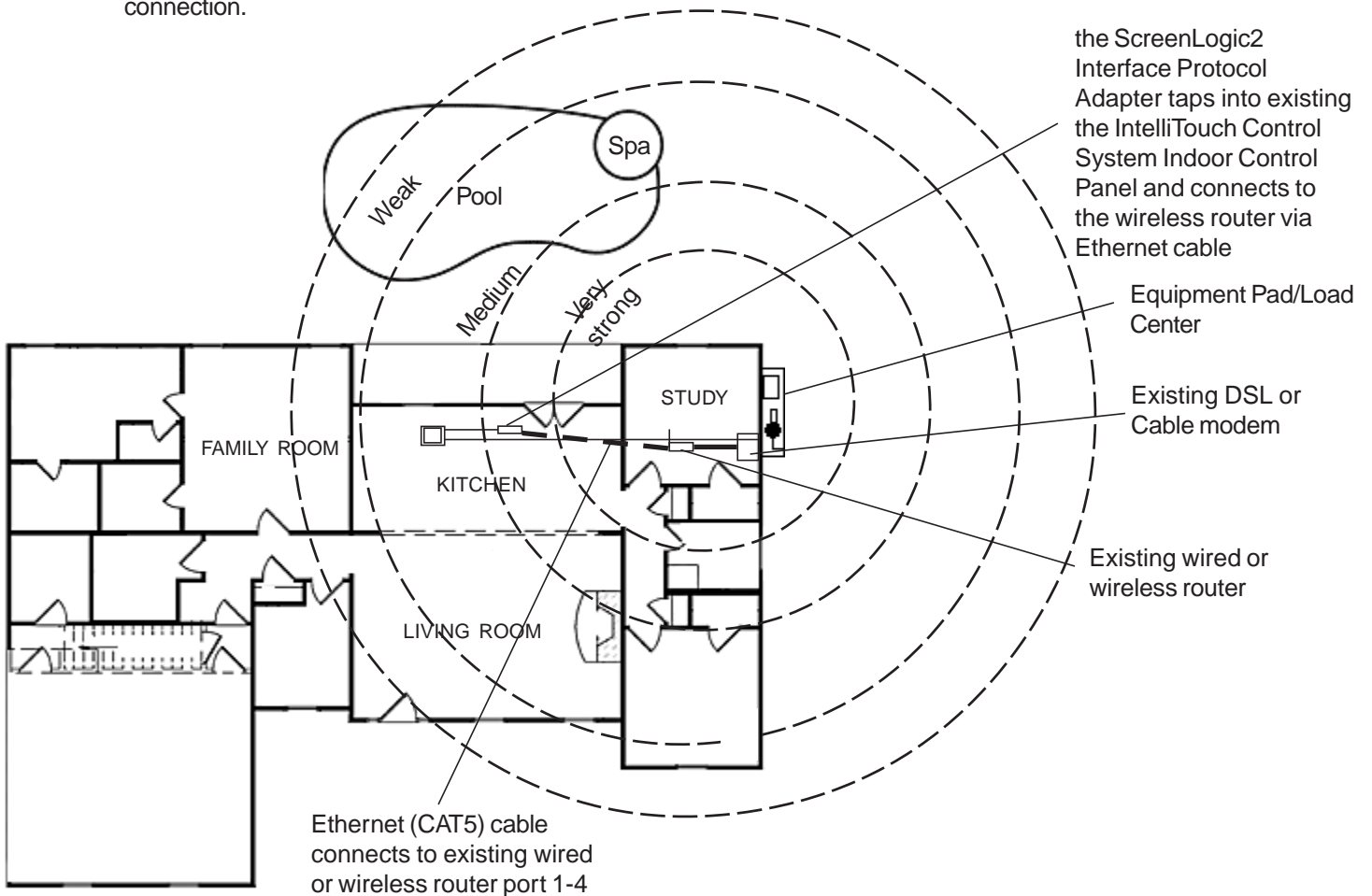

## Connecting without Broadband Internet Access

This connection setup is for homeowner's that do not have a Broadband Internet connection.

To connect the ScreenLogic2 Interface hardware:

1. **Connect the Protocol adapter to the existing wireless router:** Connect an Ethernet cable (CAT 5) to the Ethernet RJ45 jack located on the Protocol adapter. Connect the other end of the Ethernet cable to LAN Port 1 on the back panel of the wireless router. The LED indicator for LAN Port 1 will be on to indicate proper connection. Ensure that a straight-through CAT 5 cable is used to connect to the wireless router. A crossover Ethernet cable will not work.
2. **Connect to the PC:** Insert a separate Ethernet cable (CAT 5) to the LAN Port 2 on the back panel of the wireless router, and to an available Ethernet port on the network adapter in the computer. Use a straight-through CAT 5 cable to connect to the wireless router. The LAN Port 2 LED indicator will be lit to indicate proper connection.
3. **Connect to the Protocol adapter:** Proceed to "Connect to the Protocol Adapter," page 18.

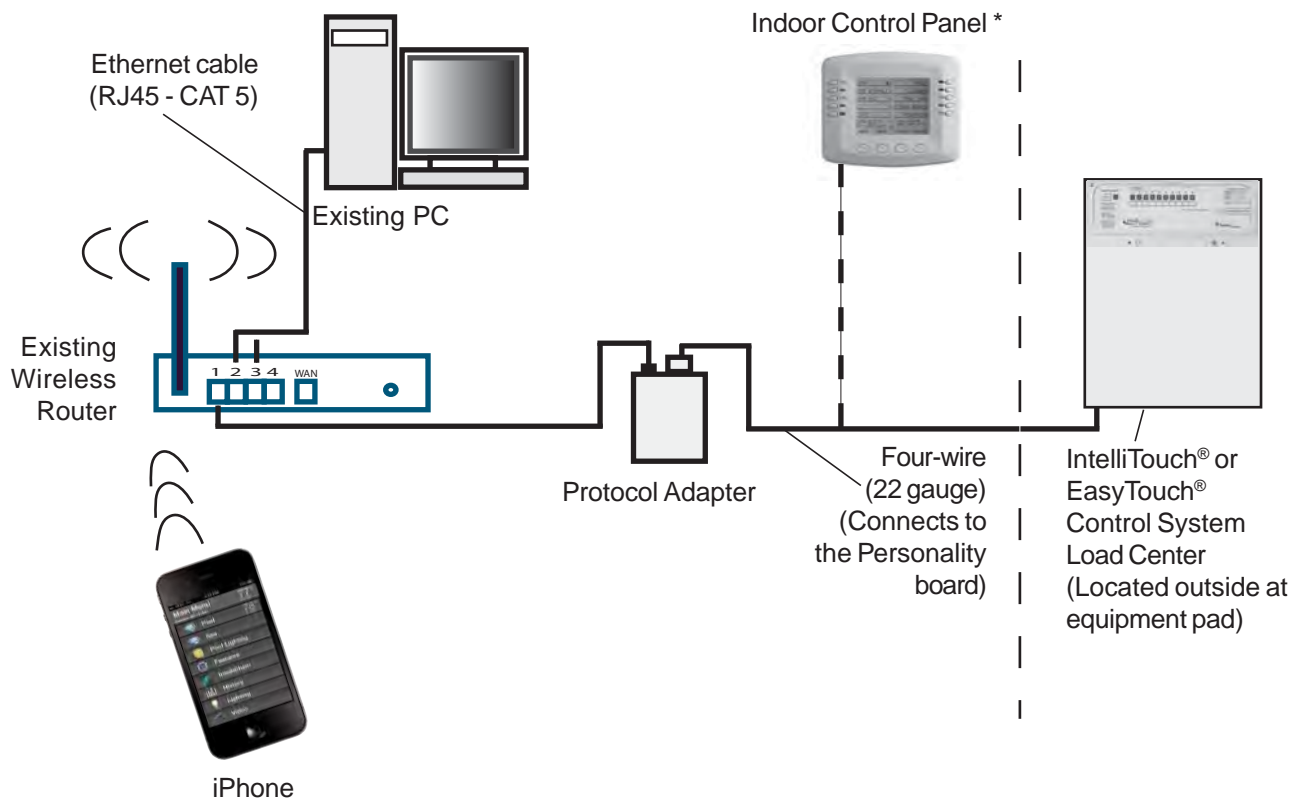

Note: (\*) Optional wiring for existing Indoor Control Panel. Tap into the Indoor Control Panel connector or pig tail off the four-wire cable connected to the Personality board.

Cable Distant Limits:

- Ethernet cable distance limit = 300 feet
- Four-wire cable distance limit = 1500 feet

## Connecting to your Home Network with Broadband Access

While not a requirement to run the ScreenLogic2® Interface, the application can coexist with and utilize your existing home network's Broadband connection. There must be either an Ethernet-based Cable or DSL modem with an established Broadband Internet account from an Internet Service Provider (ISP).

By connecting the ScreenLogic2 Interface to your existing home network you will be able to take advantage of weather forecast information and current weather conditions in your area.

### Connecting to an existing home network

To connect to an existing home network:

1. **Connect to the existing home network router:** Connect an Ethernet cable (CAT 5) to the Ethernet RJ45 jack located on the adapter. Connect the other end of the Ethernet cable to PORT 1 of the four Ethernet LAN ports located on the back of the wireless router. Use a straight-through CAT 5 cable to connect to wireless router. A crossover cable will not work.
2. **Connect to the Protocol adapter:** Proceed to "Connect to the Protocol Adapter," page 11.

## Connecting to your Home Network with Broadband Access

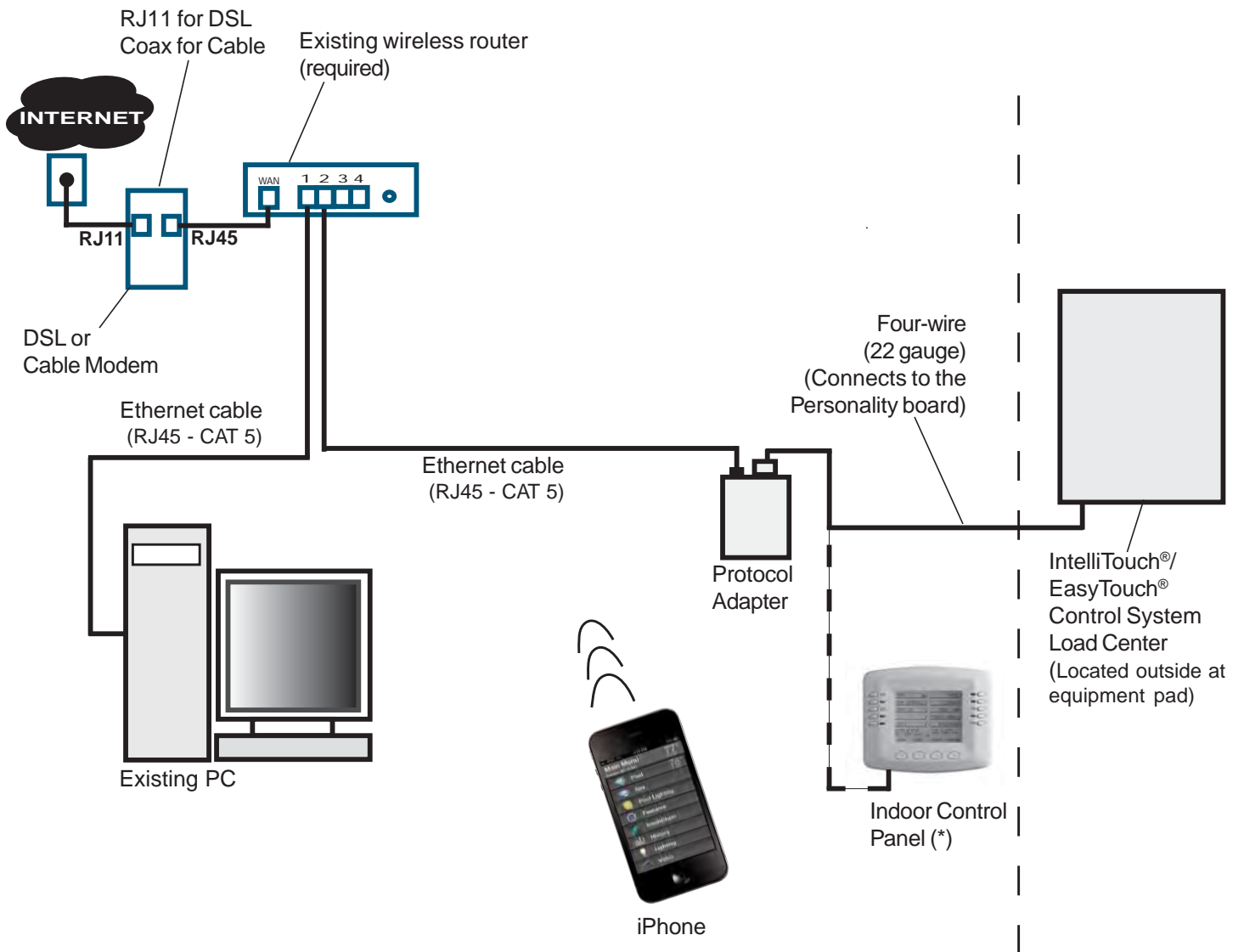

Note: (\*) Optional wiring for existing Indoor Control Panel. Tap into the Indoor Control Panel connector or pig tail off the four-wire cable connected to the Personality board.

**Cable Distant Limits:**

- Ethernet cable distance limit = 300 feet
- Four-wire cable distance limit = 1500 feet

## Connect the Protocol Adapter to IntelliTouch® or EasyTouch® Control System

The ScreenLogic2® Interface Protocol adapter is connected to the main circuit board located in the Load Center via a four-conductor cable. Before connecting the cable to the adapter, first determine the length of cable required for the connection.

**Protocol Adapter Location:** The existing wireless router and the ScreenLogic2 Interface Protocol adapter should be located inside in a dry environment, preferably near the home owners DSL/Cable modem. If the wireless router is too far from the pool area, then you may need to move the wireless router closer to the pool area by running an Ethernet cable from the DSL/Cable Modem connection out to the Protocol adapter and wireless router. For wireless router location requirement, refer to “the ScreenLogic2 Interface Location Requirements,” page 5.

**Note: Existing Indoor Control Panel** - If there is an existing the IntelliTouch or EasyTouch Control System Indoor Control Panel, you can tap directly into the wire in the home or pig tail off the connector in the Indoor Control Panel. This avoids having to run a separate four conductor cable from the Load Center to the Protocol adapter.

To connect to the Protocol adapter:

1. **Connect the Four-Conductor Cable:** Run a four conductor cable (22 AWG UL approved) from the Load Center or Power Center location to the adapter. Place the adapter in a dry area near the wireless router. Ideally, both devices should be located near the home owners DSL or Cable modem.
2. Grasp the Protocol adapter with one hand, and with your other hand gently pull outward on screw terminal connector to remove it from its socket.
3. Strip back the four cable conductors ¼ inch. Insert the four wires into the connector screw terminals. Secure the wires with the four screws. Make sure to match the color coding of the wires with the pin colors indicated on the adapter label. The pin numbers and wire color codes are:
 

|   |               |
|---|---------------|
| 1 | BLK = Ground  |
| 2 | GRN = -DT     |
| 3 | YEL = +DT     |
| 4 | RED = +15 VDC |
4. Insert the screw terminal connector onto the pins on the adapter circuit board. Note that the connector is keyed for the correct orientation.
5. Proceed to “**Connect the Protocol Adapter Load Center Circuit Board,**” page 12.

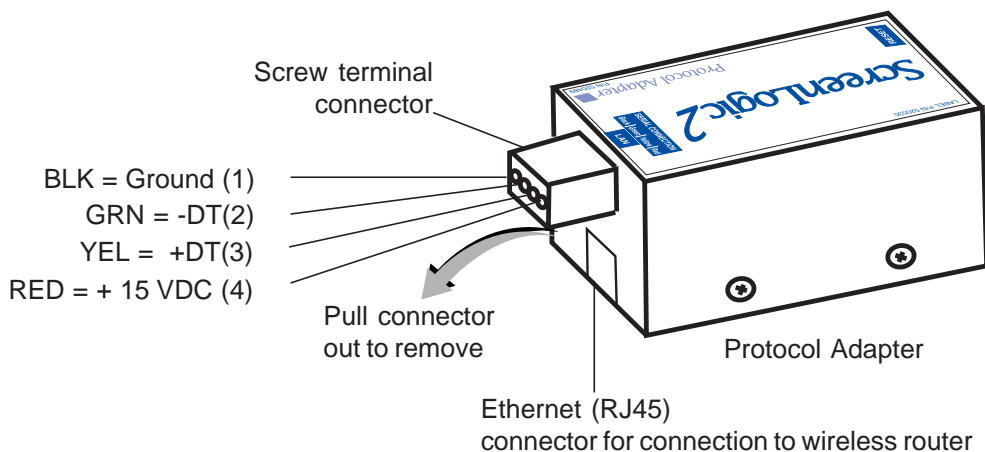



## Connect the Protocol Adapter to the Load Center Circuit Board

### ⚠ WARNING

All electrical installation, including electrical wiring methods and materials used to complete the electrical installation of the EasyTouch® and IntelliTouch® Control System **MUST BE PERFORMED BY A SERVICE PROFESSIONAL AND/OR UNDER DIRECT SUPERVISION OF A QUALIFIED ELECTRICIAN** in accordance with the National Electrical Code or the Canadian Electric Code, as well as any local electrical codes in effect at the time of installation. **Refer to NEC 680-21 (b) or CEC 687-060, 062, and 066 for further details.**

To connect the Protocol Adapter to the IntelliTouch or EasyTouch Control System load center:

- 

**⚠ DANGER**

**Switch OFF the power to the load center at the main circuit breaker before removing the High Voltage Cover Panel.** Failure to do so could result in personal injury and/or death. Shorting wires may permanently damage unit. Close all panels and load center front door when remote installation is complete.
- Unlatch the load center front door spring latch, and open the front door.
- Remove the two screws securing the **high voltage cover-panel**, and remove it from the enclosure (illustration below shows cover-panel removed).
- Loosen the two control panel access screws and fold down the outdoor control panel.
- Insert the four conductor (22 AWG) cable into the plastic grommet on the bottom of the enclosure and route the wire up through the low voltage raceway to the main circuit board.

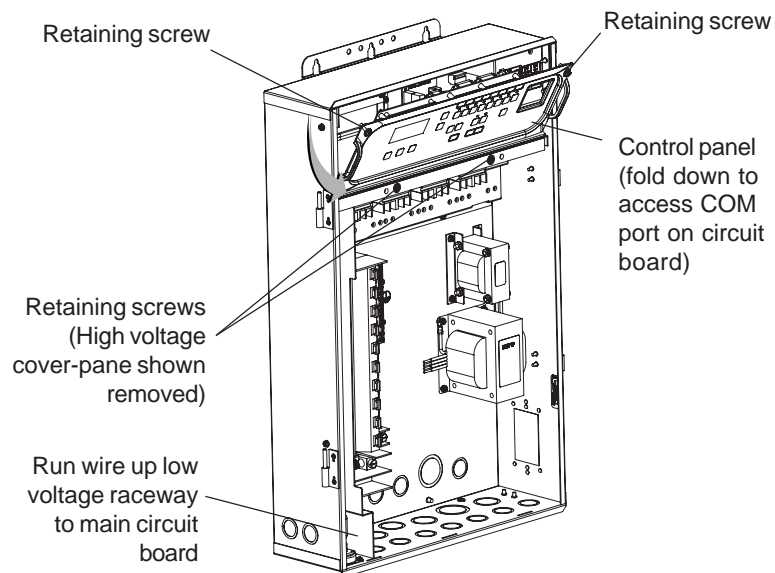

- Strip back the cable jacket one-inch and the cable conductors 1/4-inch.

**IntelliTouch® Control System:** Insert the wires into the either of the **COM PORTS (J7 and J8)** screw terminals located on the left side of the Personality board. Secure the wires with the screws. Note: Multiple wires may be inserted into a single screw terminal.

**EasyTouch® Control System:** Insert the conductors into the **COM PORT (J20)** screw terminals located on the top of the EasyTouch Control System circuit board (see diagram below). Secure the wires with the screws. For wiring details, refer to the pin configuration shown below. Note: Multiple wires may be inserted into a single screw terminal.

The pin numbers and wire color codes are:

- 1 BLK = Ground
- 2 GRN = -DT
- 3 YEL = +DT
- 4 RED = +15 VDC

**CAUTION** Do NOT short GND or +15 VDC connections (Red or Black) to data lines (Green or Yellow). The Personality board may be permanently damaged. Do NOT reverse GND or +15V or system will not operate.

- Close the control panel and secure it with the two access screws.
- Install the high voltage panel cover and secure it with the two retaining screws.
- Close the load center front door and secure the latch.
- Switch power on to the load center.

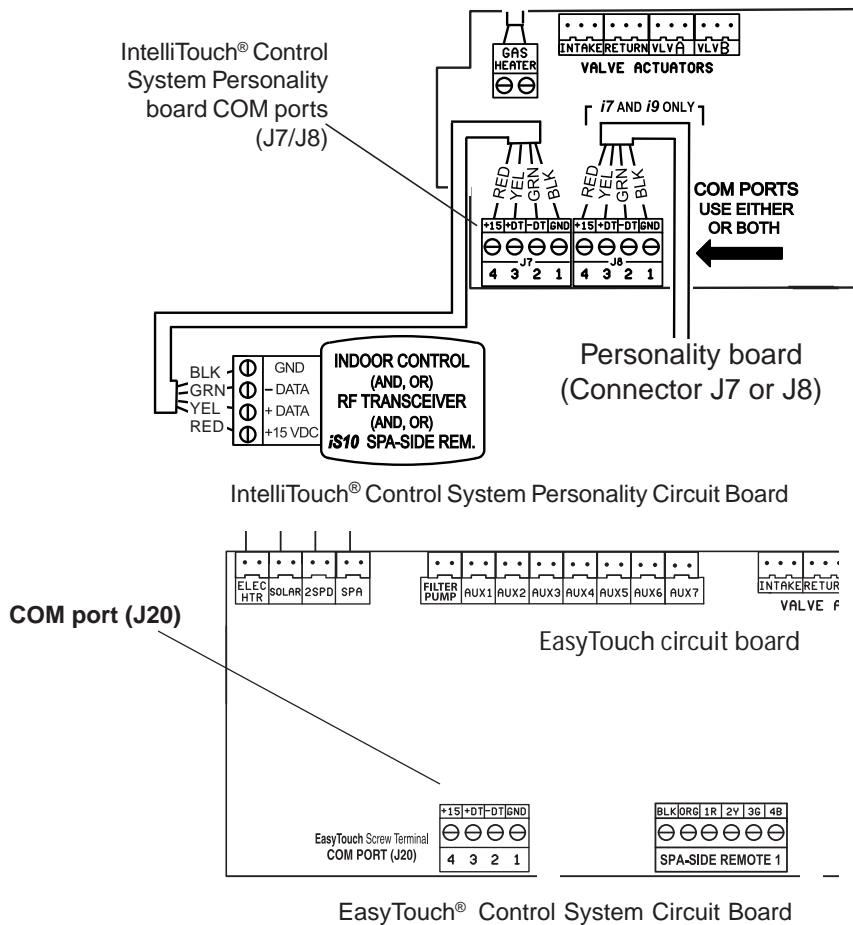

## Start up the ScreenLogic2® Interface System for the first time

After the ScreenLogic2 Interface Protocol adapter is installed, power up the system and verify that all cables are properly connected.

### To start up the system

1. **Power up the Load Center and Protocol adapter:** Switch the main power on to the Load Center. The Protocol adapter will also be switched on and its RED power LED should be lit. The Protocol adapter receives power from the COM port located in the Load Center.
2. **Connect power to the existing wired or wireless router:** Connect the AC power adapter to the receptor on the back panel of the wireless router and then plug the other end of the AC power adapter to a wall outlet or power strip. The Power LED will be on.
  - Check that the appropriate LEDs are lit on the front of the wireless router. The LED light for active LAN and WAN Port will illuminate to indicate proper connection. Note: The WAN port will only be lit if connected to the homeowner's wireless/wired router.
3. **Configure the ScreenLogic2 Interface for installed IntelliTouch® or EasyTouch® Control System equipment:** Proceed to “Accessing the ScreenLogic2 Interface Configuration Program,” page 15.

### IMPORTANT NOTE:

#### IP ADDRESS:

The ScreenLogic2 Interface protocol adapter is set to Dynamic Host Configuration Protocol (DHCP) by default. This means that the existing router will automatically assign an IP address to the Protocol Adapter. A Static IP address can be set by using the “Configure IP Info” button as show on right.

#### SYSTEM SYNCHRONIZATION:

The ScreenLogic2 Interface protocol adapter queries the IntelliTouch or EasyTouch Control System configuration when it first starts up and will continue to query the system every 30 minutes thereafter. In general, if you make a change to the IntelliTouch or EasyTouch control system (reconfigure circuits, pumps, programs, etc.) from the indoor or outdoor control panel, you need to cycle power to the ScreenLogic2 Interface protocol adapter to force a system synchronization. the ScreenLogic2 Interface will eventually detect any new changes to the configuration, but this process can take up to 30 minutes. Restarting the protocol adapter is the quickest way to synchronize the system.

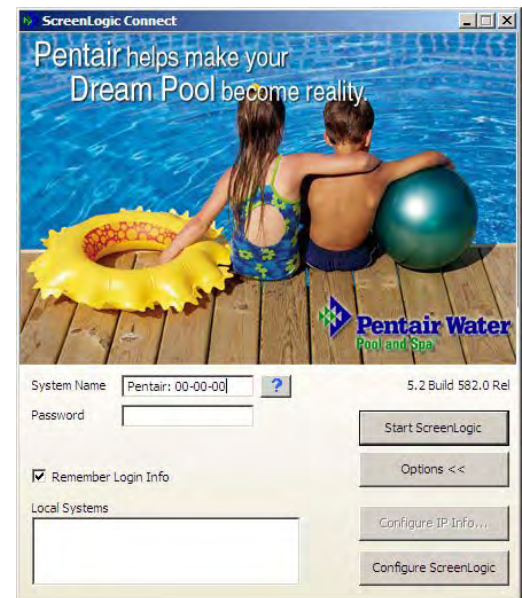

# Configuring the ScreenLogic2® Interface

## Section 2

### Accessing the ScreenLogic2 Interface Configuration Program

This section describes the Configurator utility dialogs used to configure the ScreenLogic2 Interface. Follow the Configurator utility dialogs, Steps 1 through 5 to configure the ScreenLogic2 Interface for the installed the IntelliTouch® or EasyTouch® Control System equipment.

1. If using a Mac, PC or Laptop, you must first run the setup program which can be found at [www.pentairpool.com/en/support/tools/software%20downloads](http://www.pentairpool.com/en/support/tools/software%20downloads).
2. Click on “**ScreenLogic® Software for Consumers**”. Click on the following screen links:  
**For PCs:** Click **Here** to start the download  
**For Macs:** Click **Here** to start the download
3. Click on the ScreenLogic2 Interface icon on the Desktop to launch the Configurator utility.

Note: Before starting the Configurator Utility, you must first exit from the ScreenLogic2 Interface.

### Installing the ScreenLogic2 Interface Software on a PC or Laptop

To install the ScreenLogic2 Interface software on a PC or Laptop:

1. Download and install the ScreenLogic software. **See Step 1 above for the URL.**

**For Windows Vista through Windows 10: The first time you run the ScreenLogic2 Interface program, right-click on the ScreenLogic2 Interface Connect desktop icon and choose “Run as Administrator”.**



2. Press **Next** and follow the on-screen instructions. The ScreenLogic Interface icon will be installed on your desktop.

## Start the ScreenLogic2® Interface Program

To start the ScreenLogic2 Interface after using the Configurator utility:

1. After completing Steps 1 through 5 of the Configurator utility, click the **Finish** button. The Configurator utility main screen will display.
2. Click **X** on the top right of the screen to exit the application.

To start the ScreenLogic2 Interface from the Desktop:

1. Double-click the ScreenLogic icon on your Desktop. **For Windows® Vista through Windows 10: The first time you run the ScreenLogic2 Interface program, right-click on the ScreenLogic Connect desktop icon and choose “Run as Administrator”.**
2. Click the **Start ScreenLogic** button.

## Compatibility with IntelliTouch® and EasyTouch® Control Systems

the ScreenLogic2 Interface is compatible with all versions of the IntelliTouch and EasyTouch control systems. In some cases, the ScreenLogic2 Interface may be used with an IntelliTouch control system that has an older version of firmware. Some of the ScreenLogic2 Interface features will not operate unless the IntelliTouch or EasyTouch Control System firmware is up to date. Example features that may not work include support for 12 lights, Dimmer module support, IntelliFlo® Pumps, IntelliChem® Controller and 3rd party chlorinator support. Contact your pool builder or Pentair to upgrade to the latest IntelliTouch or EasyTouch Control System firmware if these features are necessary.

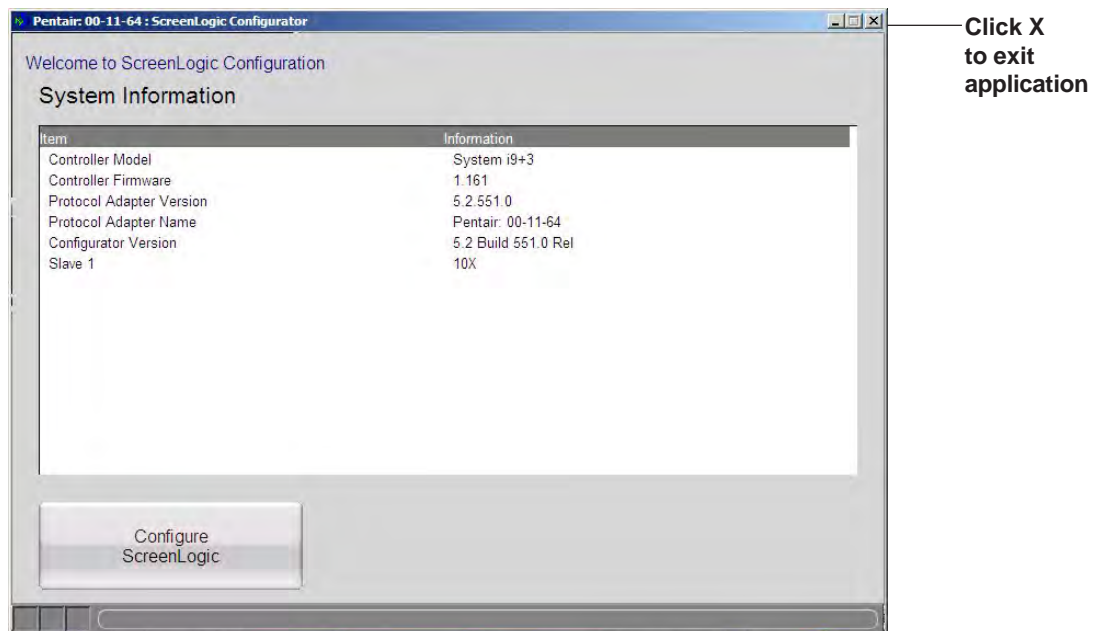



## ScreenLogic2® Interface Configuration and Maintenance Screen

The Configurator utility opening screen displays the type of the IntelliTouch® or EasyTouch® Control System equipment, firmware and software versions being used. From this screen you can start the Configurator utility to configure the ScreenLogic2 Interface for the IntelliTouch or EasyTouch control system, or start the ScreenLogic2 Interface program.

- **To start the Configurator utility:** Tap the **Configure ScreenLogic** button. Proceed to configure the ScreenLogic2 Interface using the dialogs (Steps 1 through 5). After you are done, click the **Finish** button to return to the opening screen.
- **To start the ScreenLogic2 Interface:** Tap the **Start ScreenLogic** button. The Home screen is displayed.

### General Settings (Step 1 of 5)

**General Settings (Step 1 of 5)**

**Clock**  
 Date: 4/ 4/2011  
 Hour: 2 PM Min: 09  
 Automatically Adjust for DST

**Temperature Scale**  
 Fahrenheit  Celsius

**Priority**  
 Manual DP Priority

**Home Page**  
 Pentair Status + Weather  
 Show Alerts

**Location**  
 ZIP Code: 93012  
 Latitude (North): 42.5  
 Longitude (West): 70.87  
 Time Zone: GMT -8

**Weather Source:** USA (Automatic by ZIP Code)  
**Weather Params:** http://www.weather.gov/xml/curre  
 Locate Current Conditions Airport

**Calibrate Sensors**  
 Air: Dn 81 F Up  
 Water: Dn 76 F Up  
 Apply Calibration

Email Alert Settings... Set Remote Access Password...

<< Back Next >> Finish

Use the following Time Zone table to determine your location.

| U.S. Time Zone                      | Greenwich Mean Time (GMT) |
|-------------------------------------|---------------------------|
| Hawaiian Time                       | (GMT -10:00)              |
| Alaskan Time                        | (GMT -09:00)              |
| Pacific Time (US & Canada); Tijuana | (GMT -08:00)              |
| Mountain Time                       | (GMT -07:00)              |
| Central Time                        | (GMT -06:00)              |
| Eastern Time                        | (GMT -05:00)              |

## General Settings (Step 1 of 5) Continued

| Name                       | Description  |
|----------------------------|--|
| Clock                      | <p>The date &amp; time set in the Configurator utility sets all system clocks for the In-Wall touch screen, Tablet, IntelliTouch Outdoor Control Panel, and Indoor Control Panel. If the PC time &amp; date do not match the time &amp; date displayed on the ScreenLogic Home screen, you need to reset the PC time &amp; date to the time &amp; date set in the Configurator utility. Note: Time &amp; date synchronization for all systems may take a few minutes.</p> <p><b>Date:</b> Set the current day, month and year.<br/> <b>Hour:</b> Set the current hour (AM/PM) and Minutes.<br/> <b>Time Zone:</b> Set the time zone for your location.</p> |
| Location                   | <p><b>ZIP code:</b> ZIP code for your location. U.S. Zip code information will automatically populate the Latitude and Longitude coordinates and Time Zone. These settings display the weather forecast and conditions, sunset, and sunrise information for your area. This feature requires a Broadband Internet connection.</p>  |
| Temperature Scale          | <p><b>Fahrenheit/Celsius:</b> Display Set Point and Actual temperatures in degrees Fahrenheit or Celsius.</p>  |
| Calibrate Sensors          | <p><b>Air - Down/Up:</b> Lower/Raise current temperature.<br/> <b>Pool - Down/Up:</b> Lower/Raise current temperature.<br/> <b>Spa - Down/Up:</b> Lower/Raise current temperature.</p>   |
| Manual OP Priority         | <p><b>Manual Operation Priority:</b> When enabled, this feature will turn off any scheduled program to allow manual pump override. The manual function default time is 12 hours, after which the scheduled program will resume.</p>  |
| Home Page                  | <p><b>Pool Summary:</b> Displays the current pool, spa and air temperatures, and set points, heat mode status, and enabled auxiliary circuits (yellow) that correspond to buttons (yellow) on the ScreenLogic Main screen.<br/> <b>Weather Only:</b> Displays your current weather conditions on the Home page. You must be connected to the Internet to display current weather conditions for your location.<br/> <b>Weather + Pool Summary:</b> Displays your current weather conditions and system information on the Home page.</p>   |
| Set Remote Access Password | <p>Use this button to access the "Set Remote Access Password" dialog. The default password is blank (no password in both password boxes. Asterisks will appear in place of the entered password. The password used in this dialog must match the password used to access your system remotely. If you forget your password, erase the asterisks from the "New Password" and Confirm Password" boxes. The default password (blank) will be used. Click OK to save the password. See "Connecting remotely to your system" on page 82 for information about accessing your system remotely.</p>   |
| Email Alert Settings       | <p>Enter the email address where you would like system alerts to be mailed.</p>  |
| Back button                | <p>Go to previous page.</p>  |
| Next button                | <p>Go to the next page (Step 2 of 5)</p>   |
| Finish button              | <p>Save current settings and exit the Configurator utility.</p>  |
| Alerts                     | <p>Displays that there is a system alert on the Home page. The actual alert can be viewed on the "Delays &amp; Alerts" page.</p>   |

## Changing the Display to Show Fahrenheit to Celsius

Temperature set point and actual temperature settings are displayed on the Main screen in either Fahrenheit or Celsius.

To change the temperature scale:

1. Start the ScreenLogic2 Interface Configurator utility, and tap **Configure ScreenLogic**.
2. On the General Setting page under **Temperature Scale**, tap either Fahrenheit or Celsius.
3. Tap **Finish** when done to save the setting.

## Calibrating Temperature Sensors

The IntelliTouch® and EasyTouch® Control System includes two temperature sensors for water and ambient air temperature. The IntelliTouch i10+3D model for dual bodies of water has three sensors. You can add an additional sensor for controlling solar heating systems.

Generally, these sensors are accurate and you do not have to calibrate them. However, long plumbing runs and water features can cause temperatures at a body of water to be different from the temperature sensor reading. You can manually recalibrate the sensors to adjust for this.

Before you start, you need an accurate all weather thermometer. If you are calibrating the air sensor, wait until the sensor is not in direct sunlight.

There is a Water Temp and Air Temp setting. If you have an IntelliTouch Control System i10+3D system, you will see **Spa Temp**, **Pool Temp**, and **Air Temp**. Calibrate the Spa and Pool temperatures the same way as described below for Water Temp. For the i5, i5S, i7+3, or i9+3 system, there is a water and air temperature sensor. Make sure to locate the air temperature sensor in the shade for accurate readings.

To calibrate the air, pool and spa sensors:

1. First, tap the **Pool** or **Spa** button on the ScreenLogic2® Interface Main screen to switch on the spa or pool filter pump.
2. Tap **Configure ScreenLogic** to start the ScreenLogic2 Interface Configurator.
3. Place thermometer in the spa or pool. Take an accurate temperature reading. When calibrating the air sensor, place thermometer next to the air sensor. The sensor is normally located near or under the Load Center or Power Center enclosure, not inside the enclosure. Take an accurate temperature reading in the shade.
4. On the General Setting page under **Calibrate Sensors**, use the **Up** or **Down** buttons to raise or lower the Air, Pool and Spa temperature to match the corresponding thermometer temperature reading. If you have an i10+3D repeat the above for the pool.
5. Press the **Apply Calibration** button when done.



## Setup Circuits (Step 2 of 5)

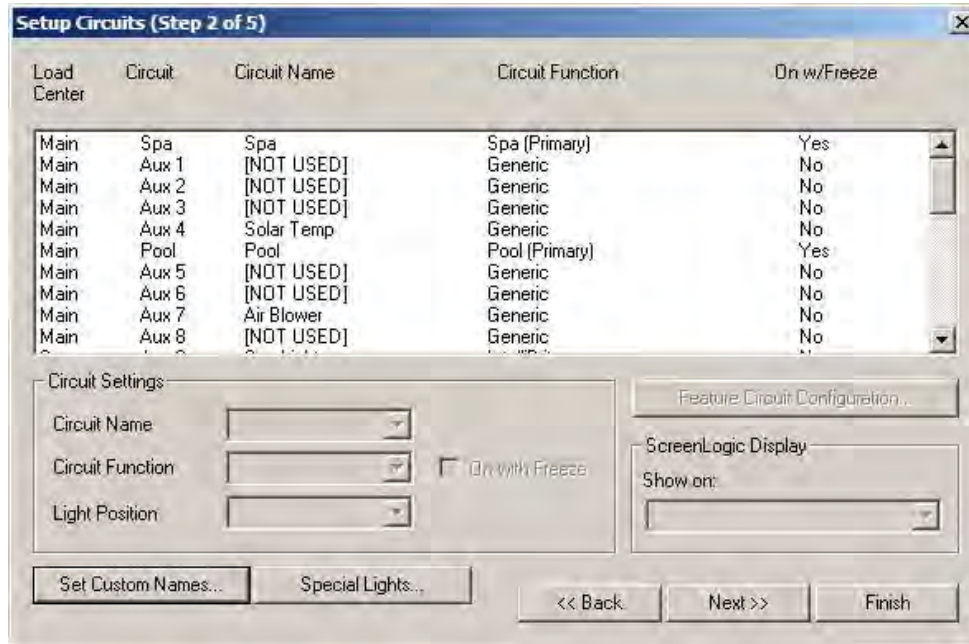

| Name                    | Description  |
|-------------------------|--|
| Setup Circuits          | Displays the available circuits for the system.<br><br><b>Load Center:</b> Displays the installed Load Center or Expansion Center(s).<br><b>Circuit:</b> Displays the available AUX circuits and Feature circuits (1-10). Depending on the model of the IntelliTouch system, the number of AUX circuits may vary. AUX circuits are located on the Personality board.<br><b>Circuit Name:</b> Assigned circuit name.<br><b>Circuit Function:</b> Assigned circuit function.<br><b>On w/Freeze:</b> Circuit assigned with freeze protection.   |
| Circuit Settings        | Displays the available circuit name, functions, and Pentair lighting features for selected circuits displayed in the main list.<br><br><b>Circuit Name:</b> Name of circuit (see page 32 for complete list of IntelliTouch circuits names). Also includes 20 user defined names.<br><b>Circuit Function:</b> Name of circuit function (see page 31 for list).<br><b>On with Freeze:</b> Select this option to switch on any circuit, such as a Pool and Spa circuit if the air temperature drops below 36° F. For a Pool circuit, the filter pump will have freeze protection. For a Spa circuit, the filter pump will run and the pool/spa valves will switch between pool and spa at 15 minutes intervals throughout the freeze condition. For the Master Cleaner circuit, freeze protection is not needed. Pool cleaner pumps receive water flow from the filter pump.<br><b>Light Position:</b> Position of pool, spa or landscape lights. |
| Set Custom Names button | Assign a custom name to a circuit. See page 34 for details.  |
| Special Lights button   | Assign IntelliBrite, SAM, SAL color lights, Color Wheel, and other incandescent colored lights to display in the Lights page. See page 36 and 52 for details.  |
| ScreenLogic Display     | Show on: <b>Pool:</b> Place a button for a specific circuit under "Pool" on the Main screen. <b>Spa:</b> Place a button for a specific circuit under "Spa" on the Main screen. <b>Water Features:</b> Place a button for a circuit under "Water Features" on the Main screen. If you choose a Lights circuit function or Sam/Sal light, the light button is always displayed on the Lights screen.   |
| Back button             | Goto previous page.  |
| Next button             | Go to the next page (Step 3 of 5)  |
| Finish button           | Save current settings and exit the Configurator utility.   |

## Setup Circuits (Step 2 of 5) continued

### Special Lights Button

Use this button to display the “Special Lights” dialog. Lights displayed in this dialog are circuits that are assigned as “Lights.” All Lights assigned in this dialog will be controlled by the All Off, All On, Color Set, Color Sync, and Color Swim buttons on the Lights screen. Up to 12 lights and the Color Wheel can be configured to use the Color Set, Color Sync, and Color Swim lighting features.

Note:

- IntelliTouch control system supports 12 special lights.
- EasyTouch control system supports 8 special lights.

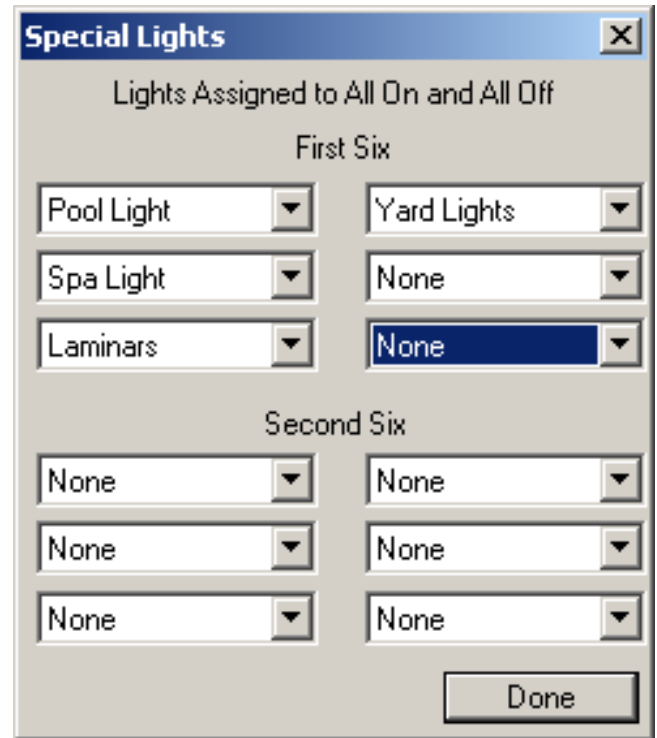

### Feature Circuit Configuration Button

The **Feature Circuit Configuration** button is enabled after you select a Feature Circuit (1 - 10) from the main list of circuits, assign a circuit name and circuit function. Use this button to access the “Configure” dialog. The selected Feature Circuit will be the name of the macro (i.e. Fountain). To access the Feature Circuits, scroll down to the end of the available AUX circuits, select the name of the Feature Circuit. There are 10 available Feature Circuit names that can be assigned multiple functions in the Configure Macro dialog. You can also assign a custom name to the circuit (see page 34).

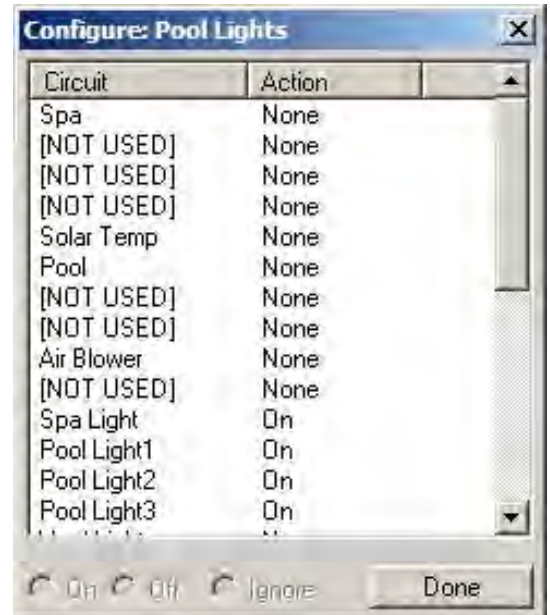

| Name          | Description   |
|---------------|---|
| Circuit       | Displays the available circuits that can be used as a macro circuit. This button is enabled when a Feature Circuit is selected from the list of circuits. |
| On/Off Ignore | Select On to activate a selected Macro circuit. To switch a Macro off, select Off. Select Ignore, to not use the selected Macro.                          |
| Done button   | Save setting and close dialog.  |

## Feature Macro Circuits Overview

The IntelliTouch® Control System “Feature Macro Circuits” can control equipment that is not controlled by AUX circuits. In general, AUX circuits are used for high voltage equipment like pumps and lights, whereas Feature Macro Circuits are used for low voltage equipment like valve actuators. However, Feature Macro Circuits can go beyond this definition, and be used in other creative ways. For example, a Feature Macro Circuit can be used to create a Macro circuit in which several other circuits can be switched on or off with the same button. There is a limit of 10 Feature Macro circuits in the system.

**Note: The EasyTouch Control System does not support “Macro Circuits.”**

- **Valve Actuators** - Feature Macro Circuits may be assigned for controlling up to five valve actuators per Load Center. To control a total of five actuators requires the installation of the optional Valve Module (P/N 520285) which includes three additional actuators outputs (C, D, and E) per Load Center. For more information about configuring valve actuators, refer to pages 35-36. Note: The EasyTouch control system only supports Valves A & B.

*Note: When using solar heat, note that for **shared equipment** pool and spa combination, valve A is always used for solar. For **dual body dual equipment**, valve A is always the pool and valve B is always the spa.*

- **Two-Speed Pump** - A Feature Circuit may be assigned as a way to switch a two-speed Filter Pump from high speed to low speed.
- **Spa Spillway** - A Feature Circuit may be assigned to activate the Spa Spillway effect, where in a pool/spa combination, pool water is diverted to the spa then spilled back into the pool.

*Note: For details on setting up Feature Circuits, see “Creating a Feature Circuit Macro,” page 22.*

## Freeze Protection

Freeze protection switches on a circuit if the outdoor air temperature sensor detects the temperature is getting close to freezing (below 36° F). The system cycles through all circuits that have been assigned freeze protection, and runs the circuits for 15 minutes to stop the pipes from freezing. This is especially important if there is a pool and spa combination. If freeze protection is set to both the spa and pool circuits, the filter pump switches on and the pool and spa valves alternate every 15 minutes to keep the water moving in both the pool and spa. This process continues until the freeze condition is over.

## Assign a Circuit Name and Function

**Note:** Before you assign circuit names in the ScreenLogic2® Interface, write down the circuit names and assigned buttons on the Outdoor Control Panel (in the Load Center). The circuit names you assign in the ScreenLogic2 Interface should match the button labels on the Outdoor Control Panel.

Circuit Functions let you assign special logic to the circuits. For example, when setting up an automatic pool cleaner pump, you would assign the circuit function MASTER CLEANER. With this “Cleaner” logic the cleaner pump would not run without the filter pump being on first, and, the cleaner pump would automatically shut off whenever the spa is switched on. The cleaner will go on after the five minute delay. Also, the automatic cleaner pump will turn off when the spa and/or solar is turned on. Be careful not to duplicate circuit names with these circuits. These circuits may also be used to activate two-speed pumps to high speed, turn additional valves, etc.

To assign a circuit name:

1. Start the ScreenLogic2 Interface Configurator and click **Configure ScreenLogic**.
2. Click **Next** on the **General Setting** page. The Setup Circuits (Step 2 of 5) page is displayed.
3. From the **Circuit Name** drop box, scroll through the alphabetical list of predefined circuit names and select a circuit name. For a complete list of the Circuit Functions, see page 24.

***Note:** You can also customize circuit names. To enter a custom circuit name, click **Set Custom Names**, and select one of the user names (USERNAME 01-20) and type in the new circuit name (11 characters maximum). The Custom Names (USERNAME 01-20) can be found at the bottom of the circuit name drop down box.*

4. From the **Circuit Function** drop-down box select the function assigned to the circuit name. For a complete list of the circuit functions, see page 24.

***Note:** If the assigned function requires freeze protection, select the check box for “On with Freeze.”*

***Note:** When you are finished setting the first circuit name and circuit function, repeat Steps 3 and 4 and assign the other circuits and functions. Depending on the model you are programming, equipment may not be installed for all available circuits shown.*

5. **Display Circuit Button on the ScreenLogic2 Interface main screen:** For easy access, the assigned circuit button can be displayed under Pool, Spa, or Features tab in the ScreenLogic2 Interface. To display the button on the Main screen, select where you want the button to display in the **Show with** drop-down box.

***Note:** IntelliBrite®, SAM®, SAL® lights, and Color Wheel buttons will always display on the Lights screen.*

6. Click **Finish** to save the current settings.

## Circuit Functions

The following Circuit Functions allow you to assign special logic to the circuits.

*Note: To ensure proper operation, some circuits shown below will only display on certain screens. For example, IntelliBrite® and SAm® and SAL® Lights will always display on the Lights screen, not on the Main screen.*

|                         |  |
|-------------------------|--|
| <b>Generic</b>          | No special Logic. Simple On/Off control of a circuit with all the programmable capabilities.   |
| <b>Master cleaner</b>   | Works with automatic pool cleaner pumps or cleaner valve actuator. It does the following: <ul style="list-style-type: none"> <li>- Forces the filter pump on 5 minutes before the cleaner.</li> <li>- Turns the cleaner off when the spa is on.</li> <li>- Turns the cleaner off for 5 minutes when the solar heating begins.</li> </ul> |
| <b>Light</b>            | Allows special lighting features to work, such as ALL lights on or ALL lights off.   |
| <b>Dimmer</b>           | Allows light dimming features to work. Dimming relay must be installed.  |
| <b>SAM Light</b>        | Activates special color lighting programs on other screens on the Indoor Control Panel when used with SAM pool lights. For example, you can have ALL lights on or ALL lights off, or use Color Swim, Color Set, or Color Synch.  |
| <b>SAL Light</b>        | Activates special color lighting programs on other screens on the Indoor Control Panel when used with SAL spa lights. For example, you can have ALL lights on or ALL lights off, or use Color Swim, Color Set, or Color Synch.   |
| <b>Photon Generator</b> | The Photon Generator® light source allows the Fiberworks® fiber optic bulb be operated by Color Set or Color Swim programs when used with SAM and SAL lighting.  |
| <b>Color Wheel</b>      | Activates special color lighting programs on other screens on the Indoor Control Panel when used with Fiberworks.  |
| <b>Valve</b>            | Not currently used.  |
| <b>Spillway</b>         | For pool/spa combinations where the spa is raised above the pool. This setting moves the return valve so that the filter pump pulls the water from the pool and returns it to the spa, creating a water fall effect. Automatic pool cleaners are turned off when this feature is turned on.  |
| <b>Floor Cleaner</b>    | Rotates a 3-way valve every 20 minutes alternating flow between two cleaner system valves that feed the pop-up heads.  |
| <b>IntelliBrite</b>     | Activates an IntelliBrite LED light.   |
| <b>MagicStream</b>      | Activates a MagicStream laminar water feature.   |

Note: **Assigning Floor Cleaner function:** If a multi-head (six head) in-floor cleaner system or an IntelliFlo pump is being used, assign the equipment to the “GENERIC” circuit function, **not** the “Floor Cleaner” function. Assigning the “Generic” circuit function ensures that the pump will not ramp up and down every 20 minutes.

## Circuit Names

AERATOR  
 AIR BLOWER  
 AUX 1  
 AUX 2  
 AUX 3  
 AUX 4  
 AUX 5  
 AUX 6  
 AUX 7  
 AUX 8  
 AUX 9  
 AUX 10  
 BACKWASH  
 BACK LIGHT  
 BBQ LIGHT  
 BEACH LIGHT  
 BENCH  
 BLOWER  
 BOOSTER PUMP  
 BUG LIGHT  
 CABANA LTS  
 CHEM. FEEDER  
 CHLORINATOR  
 CLEANER  
 COLOR WHEEL  
 DECK LIGHT  
 DRAIN LINE  
 DRIVE LIGHT  
 EDGE PUMP  
 ENTRY LIGHT  
 FAN  
 FIBER OPTIC  
 FIBERWORKS  
 FILL LINE  
 FLOOR CLNR  
 FOGGER  
 FOUNTAIN  
 FOUNTAIN 1  
 FOUNTAIN 2  
 FOUNTAIN 3  
 FOUNTAINS  
 FRONT LIGHT  
 GARDEN LTS  
 GAZEBO LTS  
 HIGH SPEED  
 HIGH TEMP  
 HOUSE LIGHT  
 JETS  
 LIGHTS  
 LOW SPEED  
 LOW TEMP  
 MALIBU LTS  
 MIST  
 MOTOR VALVE  
 MUSIC

(NOT USED)  
 OZONATOR  
 PATH LIGHTS  
 POOL SAM 3  
 SECURITY LT  
 SLIDE  
 SOLAR  
 SPA  
 SPA HIGH  
 SPA LIGHT  
 SPA LOW  
 SPA SAL  
 SPA SAM  
 SPA WTRFLL  
 SPILLWAY  
 SPRINKLERS  
 STREAM  
 STATUE LT  
 SWIM JETS  
 WTR FEATURE  
 WTR FEAT LT  
 WATERFALL  
 WATERFALL 1  
 WATERFALL 2  
 WATERFALL 3  
 WHIRLPOOL  
 WTRFL LGHT  
 YARD LIGHT

### Custom Names (11 characters maximum)

USER NAME 01 \_\_\_\_\_  
 USER NAME 02 \_\_\_\_\_  
 USER NAME 03 \_\_\_\_\_  
 USER NAME 04 \_\_\_\_\_  
 USER NAME 05 \_\_\_\_\_  
 USER NAME 06 \_\_\_\_\_  
 USER NAME 07 \_\_\_\_\_  
 USER NAME 08 \_\_\_\_\_  
 USER NAME 09 \_\_\_\_\_  
 USER NAME 10 \_\_\_\_\_  
 USER NAME 11 \_\_\_\_\_  
 USER NAME 12 \_\_\_\_\_  
 USER NAME 13 \_\_\_\_\_  
 USER NAME 14 \_\_\_\_\_  
 USER NAME 15 \_\_\_\_\_  
 USER NAME 16 \_\_\_\_\_  
 USER NAME 17 \_\_\_\_\_  
 USER NAME 18 \_\_\_\_\_  
 USER NAME 19 \_\_\_\_\_  
 USER NAME 20 \_\_\_\_\_



## Creating a Feature Circuit Macro (IntelliTouch® Control System only)

Feature Macros give you the ability to combine various circuits together so a single button can operate them all at once. For example, you could create a Macro that would give you one button that turns on your spa, spa light, fountain, fountain light, and patio lights. A Macro also has the capability to switch a circuit off. You can assign a name to your Macro from the list of IntelliTouch control system circuit names. For the complete list of names, see “IntelliTouch® Control System Circuit Names,” page 25. You can also create your own custom name, for example, SPA PARTY could be used if there was a spa fountain which should not be on when spa is on (because it could put cold water in the spa) it can be set up in the Macro to automatically switch off when SPA PARTY is switched on. An OFF Macro can also be used to switch any number of lights off with one button.

Before you create a Feature Macro circuit, first assign a feature circuit name and function, (see page 23).

*Note: A Feature circuit may not be set as Dimmers although they can turn on light dimming circuits.*

To create a Macro circuit:

1. Start the ScreenLogic2 Interface Configurator and tap **Configure the ScreenLogic2 Interface**.
2. Tap **Next** on the General Setting page. The **Setup Circuits (Step 2 of 5)** page is displayed.
3. From the main list of assigned circuits, scroll the list down after the AUX circuits until the Feature circuits are displayed.
4. Tap the **Feature Circuit configuration** button. The selected macro dialog box is displayed.
5. From the list of circuits, select the circuit that will control a valve:
  - To switch a circuit ON, tap **On**.
  - To switch a circuit OFF, tap **Off**.
  - To set a circuit to be unaffected by the macro, tap **Ignore**.

*Note: Be careful when you select circuits to switch on. One macro can switch on another macro circuit, resulting in systems switching on or off that you do not want on or off.*

6. Tap **Done** to close and save the macro setting and close the dialog.
7. Under the ScreenLogic2® Interface Display, in the **Show on** box, select where you want the Macro button to appear. For more information about displaying buttons on the main screen, refer to “Setup circuits (Step 2 of 5),” page 20, and “Display a Circuit Function Button on the Main Screen,” page 27.
8. Tap **Finish** when done.



## Creating Custom Names for Auxiliary Circuits

There are nearly 100 circuit names stored in the IntelliTouch® and EasyTouch® Control System software (see page 25). If you cannot find one to fit your application you can create up to 10 custom names (EasyTouch control system), 20 custom names (IntelliTouch control system).

To create a custom circuit name:

1. Start the ScreenLogic2 Interface Configurator and tap **Configure the ScreenLogic2 Interface**.
2. Tap **Next** on the General Setting page. The **Setup Circuits (Step 2 of 5)** page is displayed.
3. Select an AUX circuit from the main list.
4. Tap the **Set Custom Names** button. The Custom Names dialog is displayed.
5. Tap **USERNAME-01** from the list. Enter the new circuit name in the box. The new name can be a maximum of 11 characters. The Custom Names (USERNAME 01-20) can be found at the bottom of the circuit name drop down box.
6. Tap **Set Name** to save the custom name. The new name is displayed in the Custom Names list.
7. Tap **Done** to save and close the dialog.
8. The custom name is displayed in the main Circuit Names lists and now can be used when assigning a new circuit.

## Display a Circuit Function Button on the Main Screen

An assigned circuit function can be displayed as a button on a the ScreenLogic2 Interface main screen. For more information about displaying circuit buttons on the main screen, refer to “Setup circuits (Step 2 of 5),” page 20.

To display an assigned circuit button:

1. Start the ScreenLogic2 Interface Configurator and tap **Configure the ScreenLogic2 Interface**.
2. Tap **Next** on the General Setting page. The **Setup Circuits (Step 2 of 5)** page is displayed.
3. In the list of assigned circuits, select the circuit you want to change.
4. Under the ScreenLogic2 Interface Display, in the **Show on** box, select where you want the button to appear, under Pool, Spa or Features on the ScreenLogic2 Interface Main screen. For example, if the AUX 2 circuit is assigned to a Cleaner, selecting Pool from the “Display with” box will display a Cleaner button under the Pool button on the ScreenLogic2 Interface Main screen. Up to 20 buttons can be displayed under Water Features on the ScreenLogic2 Interface Main screen. Use the right arrow button to scroll through other assigned buttons.
5. Tap **Finish** when done to save the setting.

## IntelliTouch Indoor Control Panel Circuit Names

User-defined circuit names used in the Configurator utility need to be updated in the IntelliTouch Indoor Control Panel in order for these names to display in the Indoor Control Panel.

To update the Indoor Control Panel to display the current circuit names:

1. Press **Menu > Setup > Advanced > Circuit Names**.
2. Select the new circuit name, then press the **Exit** button. The display will show the same circuit names as shown in the ScreenLogic2 Interface.

## Configure Other Equipment (Step 3 of 5)

**Configure Other Equipment (Step 3 of 5)**

**Valve Assignments**

| Load Center   | Valve    | Circuit Assigned to Valve |
|---------------|----------|---------------------------|
| Load Center 1 | Valve A: | USED BY SOLAR             |
| Load Center 1 | Valve B: | Slide                     |
| Load Center 2 | Valve A: | Spillway                  |
| Load Center 2 | Valve B: | [UNUSED]                  |

**Valve Option**

Pump off during valve action

**Water Chemistry Controllers**

Chlorinator present

IntelliChem present

**Manual Heat**

Spa Manual Heat

**Pool / Spa**

**Equipment Configuration**

Solar present     Solar is a heat pump

UltraTemp or ThermalFlo     Has cooling

**Delays**

Pump on during heater cool-down

**Circuits Needing High Speed Pump**

Add a Circuit    Remove Circuit

<< Back    Next >>    Finish

| Name                        | Description  |
|-----------------------------|--|
| Valve Assignments           | Displays the circuits assigned to valves. All IntelliTouch and EasyTouch systems can control two auxiliary valve actuators (A and B) for applications such as solar heating and water features. With the addition of the Valve Module (P/N 520285) installed in the Load Center, only the IntelliTouch system can accommodate up to three additional actuators (C, D, and E) for a total of five.<br><br><b>Load Center:</b> Valves available in the main Load Center.<br><br><b>Valve:</b> Available Load Center valve circuits A and B. Valve A may not be used with any other circuit when the "Solar present" check box is selected. Note: When using solar heat, note that for shared equipment pool and spa combination, valve A is always used for solar. For dual body dual equipment, valve A is always the pool and valve B is always the spa. |
| Valve Option                | <b>Circuits Assigned to Valve:</b> Assign a circuit to a valve.<br><b>Pump off during valve action:</b> Switch the pump off before valve actuation.  |
| Water Chemistry Controllers | <b>Chlorinator Present:</b> Check this box if there is a chlorination unit installed. For more information about operating the chlorinator unit, see page 70.<br><br><b>IntelliChem present:</b> Check this box if IntelliChem is connected.   |
| Manual Heat                 | <b>Spa Manual Heat:</b> Select this option to automatically begin spa heating whenever the spa is turned on manually. The default setting is on (box checked). If your spa is programmed to filter, the spa will not heat with this option enabled.  |

## Configure Other Equipment (Step 3 of 5) - Continued

| Name                             | Description  |
|----------------------------------|--|
| Pool/Spa - Solar Equipment       | <p>Pool/Spa equipment options indicates shared equipment. If dual body equipment is being used, Pool and Spa options are displayed, each with their own sets of equipment.</p> <p><b>Solar Present:</b> Solar heating is available. When this option is selected, <b>Valve A: Used by Solar</b>, is displayed in the Valve Assignments list, indicating that valve A is being used for solar equipment.</p> <p><b>Solar is a Heat Pump:</b> This feature uses heat pump controls instead of Solar. Select this check box if a heat pump is being used in place of a solar heating system.</p> <p><b>UltraTemp® or ThermalFlo™ Heat Pump:</b> Select this check box if there is a heat pump being used (UltraTemp or ThermalFlo).</p> |
| Delays                           | <p><b>Pump on during heater cool-down:</b> Select this check box if you have a heater or other equipment that requires that the filter pump stay on for ten minutes after the equipment goes off.</p>  |
| Circuits Needing High Speed Pump | <p>This list displays the Circuits and Feature circuits that need to have the pump in high speed mode when switched on.</p> <p>You can assign multiple circuits to a high speed pump. If any of these circuits are on, it will switch the pump to high speed mode. For example, when a fountain switches on, the pump should be in high speed mode, and in slow speed mode when switched off.</p> <p>Use the <b>Add a Circuit</b> or <b>Remove Circuit</b> button to add or remove a circuit that requires a two speed pump.</p>   |
| Back button                      | Goto previous page.  |
| Next button                      | Go to the next page (Step 4 of 5).   |
| Finish button                    | Save current settings and exit the Configurator utility.   |

## Configuring Valve Actuators (Controlled by AUX or Feature Circuit)

All IntelliTouch® and EasyTouch® Control Systems can drive two auxiliary valve actuators (A and B) for applications such as solar heating and water features. For IntelliTouch control systems only, with the addition of the Valve Module (P/N 520285), installed in the Load Center, the system can accommodate up to three additional actuators (C, D, and E) for a total of five. Before configuring auxiliary valve actuators, first assign names to the AUX or FEATURE circuits (page 23). Auxiliary valve actuators can be controlled by any **AUX** circuit or **Feature** circuit. By using FEATURE circuits to control valve actuators, you can conserve your AUX circuits for high voltage relays for controlling pumps and lights. You can also use Macro circuits to couple valve actuators with AUX circuits for specific applications.

Use the following information to calculate the number of available valves: (for IntelliTouch control systems only)

- Main Load Center or Power Center (all models) = 2 (A & B)
- Valve Module (if yes enter 3) = 3 (C, D & E)
- Number of Expansion Centers (3 x 2) = 6 (A & B)
- Number of Valve Modules on Expansion Center (3x 3) = 9 (C, D & E)

TOTAL = 20

## Configuring Valve Actuators

To assign a valve actuator:

1. Start the ScreenLogic2 Interface Configurator and tap **Configure the ScreenLogic2 Interface**.
2. Tap **Next** on the General Setting page and on the Setup Circuits page. The **Configure Other Equipment (Step 3 of 5)** page is displayed.
3. Select the Load Center or Expansion Center(s) and the AUX valve actuator (A, B) you wish to configure from the **Valve Assignments** list.

***Note:** When using solar heat, note that for **shared equipment** pool and spa combination, valve A is used for solar. For **dual body dual equipment**, valve A is always the pool and valve B is always the spa.*

**Valve A:** Can be used for solar heating or auxiliary valve actuator control. If the “Solar present” check box is selected “USED BY SOLAR” is displayed in the Valve assignment list. Valve A is automatically configured as a solar heating valve actuator.

**Valve B:** Can be configured to be controlled by any circuit. Resides on the Personality board.

**Valves C D E:** Reside on the optional Valve Module board (P/N 520285) that is plugged into the Personality board (for IntelliTouch systems only.)

4. In the **Circuit Assigned to Valve** box, select the circuit that you would like to use to control the valve actuator.
5. Repeat steps 3 and 4 for each valve actuator.
6. Tap **Finish** when done.

## Configure IntelliFlo® Pumps (Step 4 of 5)

The IntelliTouch® Control System can support up to eight IntelliFlo® VF and four IntelliFlo VS pumps in any combination with up to eight pumps. For more information refer to the IntelliFlo Pump Installation and User's Guide (P/N 350075). IntelliFlo pumps can be connected to the IntelliTouch control system as follows:

- 8 IntelliFlo VF Pumps
- 7 IntelliFlo VF Pumps - 1 IntelliFlo VS Pump
- 5 IntelliFlo VF Pumps - 3 IntelliFlo VS Pumps
- 4 IntelliFlo VF Pumps - 4 IntelliFlo VS Pumps

The name assigned to the first circuit is the pump name displayed in the ScreenLogic2 Interface screens.

IntelliFlo Pump 1

IntelliFlo pump 2

| Name                   | Description   |
|------------------------|---|
| Pump 1 (Pump 2-8 Tabs) | The address set at the pump must match the IntelliFlo pump number (tabs 1-8) selected on this screen. Pump 1 is the default address for the first pump. If there is only one pump installed, you do not need to set the pump address at the pump. Circuit assignments, flow rate and background filtering (IntelliFlo only) setup on this dialog apply to "Pump 1." If there are multiple IntelliFlo pumps, use the Pump 2-8 tabs to setup the pumps. When using multiple IntelliFlo pumps with IntelliTouch/ScreenLogic you need to assign an address to each pump. The address can be set to #1, #2, #3, #4, #5, #6, #7, or #8. |
| Type                   | Select which type of pump is being used; IntelliFlo VF or IntelliFlo VS.  |
| Background Circuit     | This circuit is tied to the "Filter Parameters," which include scheduled programmed run times, and turnovers. Assign this circuit to the "pool" circuit to enable pool filtering (see "Background Filtering").  |
| Circuit /Flow          | <b>Circuit:</b> Select the circuit to operate the pump.<br><b>Flow:</b> Select the flow rate (15-130 GPM) to the assigned circuit. The flow rate (GPM) only displays when using an IntelliFlo VF pump. When using an IntelliFlo VF pump, only "RPM" is displayed. The flow rate is not displayed. When this circuit is turned on from the Equipment pump screen, the pump will operate at the assigned GPM and will immediately override any scheduled filter programs setup to operate pool filtering (see "Background Filtering").  |
| Background Filtering   | Press this button to access the pool filtering options. For pool filtering options, see page 32.  |
| Back                   | Go to the previous page.  |
| Next                   | Go to the next page.  |
| Finish                 | Save current settings and exit the Configurator utility.  |



## Configure IntelliFlo (Step 4 of 5) - Continued

### Filtering dialog

Pool filtering schedules (start/stop times) are only used for filtering. The pump only allows four such events to exist. These schedules for the circuit (pool) are then transferred to the pump, and used to calculate the energy saving / minimum speed function of the IntelliFlo pump for the basic filter mode. See page 64 for details. IntelliFlo® VF Pump will calculate the required flow rate based on your pool size, clean filter pressure, pool turns per day and cycles per day, and will control the motor speed to keep a constant flow. IntelliFlo is constantly monitoring the filter when it detects that the system is dirty, an alert message is displayed. For more information about alert messages for IntelliFlo VF and IntelliFlo VS pump, see “IntelliFlo Screen” on page 64. You must then clean the filter by performing a Backwash cycle (see page 34).

| Section             | Parameter          | Value           |
|---------------------|--------------------|-----------------|
| Filter Parameters   | Size               | 15000 Gal.      |
|                     | Turn-Overs         | 2 Times per day |
|                     | Manual Filter      | 30 GPM          |
| Priming Parameters  | Max Prime Flow     | 55 GPM          |
|                     | Max Prime Time     | 14 Min.         |
|                     | System Max Time    | 1 Min.          |
| Vacuum Parameters   | Flow               | 50 GPM          |
|                     | Time               | 10 Min.         |
| Backwash Parameters | Max Pres. Increase | 10 PSI          |
|                     | Backwash Flow      | 60 GPM          |
|                     | Backwash Time      | 5 Min.          |
|                     | Rinse Time         | 1 Min.          |

Done

| Name              | Description   |
|-------------------|---|
| Filter Parameters | Pool filtering schedules (start/stop times) are only used for filtering. The pump only allows four such events to exist. These schedules for the circuit (pool) are then transferred to the pump, and used to calculate the energy saving / minimum speed function of the IntelliFlo for the basic filter mode.   |
| Size              | The pool "size" or "pool volume" value is expressed as 1000's of gallons (Kgal). Enter from 1 to 1000 Kgal for the pool size. The size number can be a close estimate, although the more accurate the better the turns will be done when in filter mode. Filter mode uses this value to sustain turn rates, flows, and times.   |
| Turn-Overs        | <b>1-8 turnovers</b> - You can set up to up to eight turns per day. It is recommended to set one turn per day for energy conservation for most common residential pools. Also, refer to your sanitizer recommendation for additional information.   |
| Manual Filter     | <b>15- 130 (Default 30 GPM)</b> - Manual Filter sets the flow at which the pump will run if it is turned on manually. The IntelliFlo pump will only run in the 'Filter' mode during the programmed times. For example, if the pump is programmed (start/stop times) for the pool circuit to run from 8:00 AM to 4:00 PM everyday. This program or programs are used by IntelliFlo to calculate at what speed it must run given those 'ON' times to achieve the turnover(s) for that sized pool for the basic filter mode. |

## Configure IntelliFlo Pumps (Step 4 of 5) - Continued

### Filtering dialog (Continued)

| Name               | Description   |
|--------------------|---|
| Vacuum Parameters  | Use the Vacuum mode to clean the pool manually. To operate the pump in Vacuum mode, place the IntelliTouch outdoor control panel in "Service Mode," and stop the IntelliFlo pump. The pool service person can then press the Vacuum button on the IntelliFlo pump. The pump would operate at the preset Vacuum parameters, then the blockage alert parameter would be cleared and the pump will stop. Vacuum mode only operates in flow control mode. Operating in Vacuum mode shuts off all of the pumps sensors. This mode is identical to IntelliFlo "Feature 1 and 2" except that you can manually start this mode using the Vacuum button. Safety considerations should be made when setting the Vacuum flow parameter.  |
| Flow               | Vacuum flow rate is from 15-130 GPM (Default 50 GPM)  |
| Time               | <b>1-600 minutes (10 hours)</b> - (Default 10 minutes) - This parameter can be set from 1 to 600 minutes. The typical setting is 10 minutes. This setting sets the amount of time you wish to run the pool vacuum.  |
| Priming Parameters | To "prime" a pump means filling the pump and suction pipe with water. This process evacuates the air from all the suction lines and the pump. It may take several minutes to prime depending on the depth of water, pipe size and length. It is easier to prime a pump if you allow all the air to escape from the pump and pipes. The water cannot enter unless the air can escape. Pumps do not hold prime, the pool piping system has that task. Priming is a function used every time the motor is started with a flow as reference. The "Priming Flow" function ensures the proper operation of the pump. The "System Priming Time" function ensures proper operation of the whole pool system. When the pump is priming, the control panel LCD displays "Priming" and then for a moment displays "Primed" when priming is complete. |
| Max Prime Flow     | <b>15-130 GPM (Default 55 GPM)</b> - Every time the pump starts this parameter will negotiate the maximum flow of the pump. If the flow is too high, equipment damage can occur. If the flow is too low the pump will not prime. This "flow" is system dependent and may require iteration. The pump will never flow more than this parameter is set to, however, it is common for the pump to ramp up and down quickly while priming. Always try to keep this flow as low as possible for cost savings and safety.   |
| Max Prime Time     | <b>1-15 Min. (Default 15 min.)</b> - Use this parameter to set the time that you want IntelliFlo try and prime before it reports an error. Remember that the IntelliFlo will attain prime every time it starts and goes through this cycle. The IntelliFlo mechanical seal can withstand about 15 minutes before severe damage occurs. The lower the time the quicker you will get a priming error if the system is difficult to prime. A well plumbed pool without having the strainer removed should prime in less than 30 seconds. If the strainer has been removed for cleaning and a substantial amount of air is in the system it should prime in about 60 to 90 seconds on the average, however, all systems will be different.  |



## Configure IntelliFlo Pumps (Step 4 of 5) - Continued

### Filtering dialog (Continued)

| Name                  | Description  |
|-----------------------|--|
| System Max Time       | 0-5 min. (Default 0 min.) - The average pump will prime in a short period of time because the pump has the ability to monitor itself to make sure it is primed. "System Max Time" is for systems that require high flows that priming flow can provide but it is deemed that more time is needed to fully relieve all the air. The builder can program a pre determined amount of time, up to 5 minutes, to aid in relieving the air from difficult filters or complex vertical plumbing. The "System Max Time" should only be used where large air traps become problems within the system. The display will inform the user when this is engaged and when it is finished during the priming cycle at each start up cycle.  |
| Backwash Parameters   | When the pump detects that the filter differential pressure (10 PSI difference) has increased and is now at the "Clean Filter" pressure, IntelliTouch displays an alert message that indicates that the filter must be cleaned (backwashed) to reduce the pressure. A "Filter Status" bar on the "Equipment" screen indicates the current status of the filter. See page 79 for details. To backwash the filter, you need to stop IntelliFlo, place IntelliTouch in "Service" mode, press the Start/Stop button on IntelliFlo, then press the Backwash button to start the backwash flow process. IntelliFlo will run the preset cycle time and preset flow GPM). After the backwash cycle is finished, the "Rinse" cycle with the preset duration time will be executed. After these cycles have been completed or if the Start/Stop button is pressed to stop the process, the filter status will be recalculated and the zero-pressure measured when Filter mode is operated again. When using cartridge filters the backwash cycle must be performed when cleaning or replacing filters. This helps the IntelliFlo reset its zero head pressure level. If you are charging a DE system, charge the system first during a normal running cycle. After the filter is charged, run the pump in backwash mode with the filter valve in the filter position to reset the % clean filter status. Then run the pump in filter mode. |
| Clean Filter Pressure | <b>1-50 PSI (Default is 14 PSI)</b> - The average PSI setting is between 10 PSI and 20 PSI for most pools and filters. The PSI changes can come from anywhere in the system, for example clogged skimmers or pots in pumps. Setting this parameter at a lower level will cause the alert message to come up sooner and you will have to clean your filter (cartridge) or backwash your filter (sand or DE) sooner.   |
| Backwash Flow         | <b>15-130 PSI</b> (Default 60 PSI)   |
| Backwash Time         | <b>1-60 minutes</b> (Default 5 minutes)  |
| Rinse Time            | <b>1-60 minutes</b> (Default 1 minute)   |
| Done button           | Close dialog and save settings.  |

## Setting up Additional Equipment

The following describes how to set up any special equipment that may be attached. Your system may or may not have this equipment installed.

The following information describes:

- **Setting up a two-speed pump** - Setup circuits that switch the filter pump from low to high speed.
- **Setup Solar equipment** - Enable solar or heat pump.
- **Cool-down cycle for the heater** - Set a cool-down cycle for heaters that require it.
- **Enable “Spa Manual Heat” control** - Heats the spa using the Spa button on the ScreenLogic2® Interface Main screen or the spa-side control, even when the heater is set to OFF in the Heat screen. This lets the homeowner heat the spa on-demand. Timed programs will not heat the spa.

## Setting up a Two-Speed Pump

Equipment circuits displayed on this screen will automatically switch a two-speed filter pump to high speed when these circuits are switched on. For example you can have the Filter pump switch to high speed whenever the JETS or CLEANER is on.

To assign a two-speed pump to a circuit:

1. Start the ScreenLogic2 Interface Configurator and tap **Configure the ScreenLogic2 Interface**.
2. Tap **Next** on the General Setting page and on the Setup Circuits page. The **Configure Other Equipment (Step 3 of 5)** page is displayed.
3. Scroll through the previously assigned circuit names to add another circuit for switching filter pump to high speed. Select a circuit to assign to a high speed pump from the **Add a circuit** box. Continue to add another circuit. You can use a Feature Circuit as one of the circuits which can switch the pump to high speed.

***Note:** With a dual equipment IntelliTouch® Control System i10+3D, one circuit button is assigned to control the spa pump and the pool pump. For more details, refer to “Configure Other Equipment (Step 3 of 5),” page 28.*

4. Repeat step 3 for each circuit requiring a two speed pump.
5. Tap **Finish** when done.

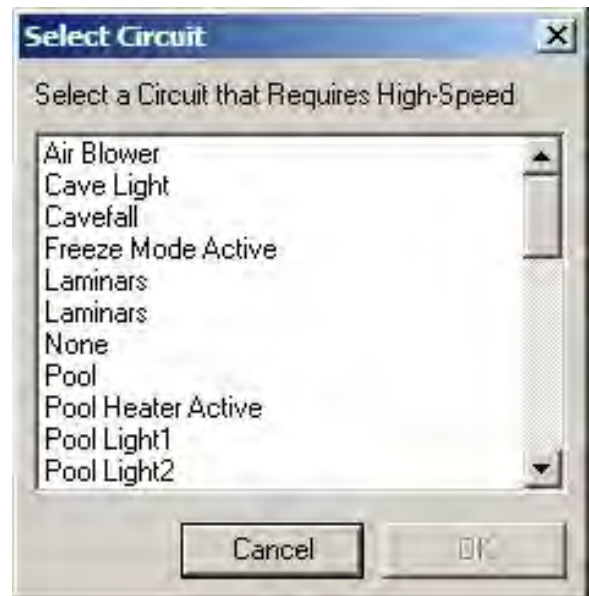

## Setup Solar Equipment and Heat pump option

Solar equipment is configured in the “Configure Other Equipment (Step 3 of 5)” dialog, page 43.

To configure solar equipment:

1. Start the ScreenLogic2 Interface Configurator and tap **Configure the ScreenLogic2 Interface**.
2. Tap **Next** on the General Setting page and on the Setup Circuits page. The **Configure Other Equipment (Step 3 of 5)** page is displayed. For IntelliTouch® Control System i10+3D Dual Equipment, tap the **Solar present** check box for each body of water with solar heating.
3. Tap the **Solar present** check box to enable solar heating. Valve A: USED BY SOLAR is displayed indicating that valve A is assigned for solar operations.
  - If your heat pump is being used instead of solar panels, tap the **Solar is a heat pump** check box, then assign a circuit to the valve in the “Circuit Assigned to Valve” box.

*Note: If solar heat source is enabled (Solar present check box selected) then the **Valve A** actuator will be dedicated to the solar valve actuator. Setting the system to Heat pump (Solar is a heat pump) will free **Valve A** for use on other valves.*

4. Tap **Finish** when done.

## Set a Cool-Down Cycle for the Heater

To activate the pump during a heater cool-down:

1. Start the ScreenLogic2® Interface Configurator and tap **Configure the ScreenLogic2 Interface**.
2. Tap **Next** on the General Setting page and on the Setup Circuits page. The **Configure Other Equipment (Step 3 of 5)** page is displayed.
3. Tap the **Pump on during heater cool-down** check box under the “Delays” option.
4. Tap **Finish** when done.

**Note:** Pentair heaters do not require this feature.

## Enable Manual Spa Heat Control

If this option is selected, your spa will begin to heat whenever it is manually turned on, (by pressing the Spa button on the ScreenLogic2 Interface Main screen), even if the heater is set to OFF. Your spa will also begin to heat when turned on by the spa-side remote, or QT4 wireless remote. This feature allows you to program your spa to filter daily with the heater set to off, and then be ready to heat whenever the SPA button is pressed manually on the ScreenLogic2 Interface Main screen. This feature is switched on by default.

To set manual heat control for the spa:

1. Start the ScreenLogic2 Interface Configurator and tap **Configure ScreenLogic**.
2. Tap **Next** on the General Setting page and on the Setup Circuits page. The **Configure Other Equipment (Step 3 of 5)** page is displayed.
3. Tap the **Spa Manual Heat** check box.
4. Tap **Finish** when done.

## Chlorine Generator

The IntelliTouch® Control System is designed to operate with the following salt chlorine generators:

- **Pentair IntelliChlor® SCG (EasyTouch® Control System only)**
- **AutoPilot® Pool Pilot Digital**
- **GoldLine® Aqua Rite®**
- **Clear Tech Automation AutoClear® Plus**

**Note:** Call your manufacturer for compatibility with IntelliTouch control systems.

### Activate the Chlorinator Control Interface

Before operating the chlorinator control interface you must first activate the system to control the chlorinator from the ScreenLogic2 Interface. The ScreenLogic2 Interface can control the chlorinator but does not turn the chlorination system on or off. When the chlorinator control is disabled in the ScreenLogic2 Interface, the chlorinator is still operating but must be controlled at the chlorinator control panel.

To obtain chlorination status and make adjustments:

1. Start the ScreenLogic2 Interface Configurator and tap **Configure the ScreenLogic2 Interface**.
2. Tap **Next** on the General Setting page and on the Setup Circuits page. The **Configure Other Equipment (Step 3 of 5)** page is displayed.
3. Tap the **Chlorinator present** check box to enable chlorination.
4. Tap **Finish**.

*Note: For information about Chlorinator user controls, refer to “Chlorinator Tab,” page 62.*

## IntelliChem® Water Chemistry Controller

The IntelliTouch and EasyTouch Control Systems support the IntelliChem® Controller.

### Activate the IntelliChem Control Interface

Before operating the IntelliChem controller you must first activate the system to control the chlorinator from the ScreenLogic2 Interface (see page 62). the ScreenLogic2 Interface can control IntelliChem controller but does not turn the IntelliChem controller on or off. When the IntelliChem control is disabled in the ScreenLogic2 Interface, the IntelliChem is still operating but must be controlled at the IntelliChem control panel.

To obtain chlorination status and make adjustments:

1. Start the ScreenLogic2 Interface Configurator and tap **Configure ScreenLogic**.
2. Tap **Next** on the General Setting page and on the Setup Circuits page. The **Configure Other Equipment (Step 3 of 5)** page is displayed.
3. Tap the **IntelliChem present** check box to enable IntelliChem.
4. Tap **Finish**.

*Note: For information about Chlorinator user controls, refer to “Chlorinator Tab,” page 62.*

## Configure 10-Button Spa-Side Remote (Step 5 of 5)

**Note:** For information about configuring switches on the a 10-button spa-side remote (SpaCommand®, Controller, iS10 Spa-Side Remote). Refer to “Configure iS4, 10-button, QuickTouch® Wireless Remote page 46.

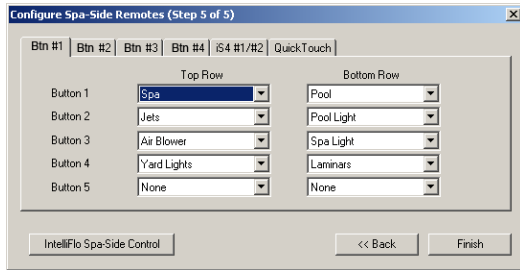

| Name                              | Description  |
|-----------------------------------|--|
| Btn#1, #2, #3, #4                 | Assign circuits for the installed SpaCommandController or iS10 Spa-Side Remote.                    |
| Button 1, 2, 3, 4, 5 (Top Row)    | Use the drop-down box to select an available circuit for the top row buttons 1, 2, 3, 4, and 5.    |
| Button 1, 2, 3, 4, 5 (Bottom Row) | Use the drop-down box to select an available circuit for the bottom row buttons 1, 2, 3, 4, and 5. |
| Back button                       | Go to previous page.   |
| Finish button                     | Save current settings and exit the Configurator utility.   |

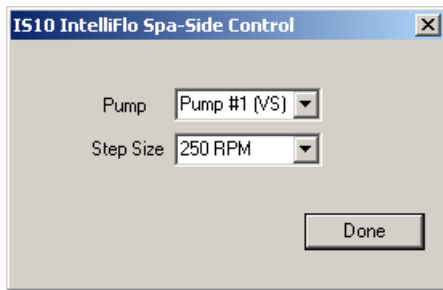

| Name              | Description  |
|-------------------|--|
| iS4 #1/#2         | Assign circuits for the installed iS4 Spa-Side Remote.                           |
| Button 1, 2, 3, 4 | Use the drop-down box to select an available circuit for buttons 1, 2, 3, and 4. |
| Back button       | Go to previous page.   |
| Finish button     | Save current settings and exit the Configurator utility.                         |

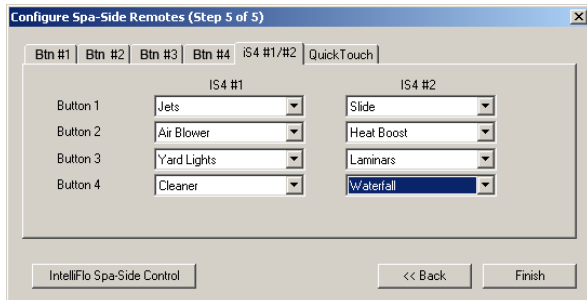

| Name              | Description  |
|-------------------|--|
| QuickTouch        | Assign circuits for the Quicktouch (II or QT4) four function remote.             |
| Button 1, 2, 3, 4 | Use the drop-down box to select an available circuit for buttons 1, 2, 3, and 4. |
| Back button       | Go to previous page.   |
| Finish button     | Save current settings and exit the Configurator utility.                         |

## Configure 10-button (SpaCommand® Controller, iS10 Remote), QuickTouch® II Wireless Controller, iS4 Spa-Side Remote

You can specify any 10-button (SpaCommand Controller, iS10 Spa-Side Remote), QuickTouch II Wireless Remote or iS4 Spa-Side remote button to control different functions.

To configure a spa-side remotes:

1. Start the ScreenLogic2 Interface Configurator utility and click **Configure the ScreenLogic2 Interface**.
2. Click **Next** on the General Setting, Setup Circuits and the Configure Other Equipment screen. The **Configure Spa-Side Remotes (Step 5 of 5)** page is displayed.
3. Select the previously assigned circuit names that will control a valve.
  - **For 10-Btn:** Select **Btn #1** for the first 10-button spa-side remote (SpaCommand or iS10) access the setup dialog. The 10-button remote has ten buttons arranged in two rows. If there are multiple remotes, select **Btn#2, Btn #3, or Btn#4**.
  - **For iS4:** Select the **iS4#1** (or #2 if there are multiple remotes) tab access the setup dialog. The iS4 has four switches that can be configured.
  - **For QuickTouch Wireless Controller (QTII, QT4):** Select the **Quick Touch** tab to access the QuickTouch setup dialog. The QuickTouch remote has four switches (buttons) that can be configured.
4. Tap the down-arrow for each of the buttons you want to configure, then select the circuit from the list.
5. Press **Finish** when done.

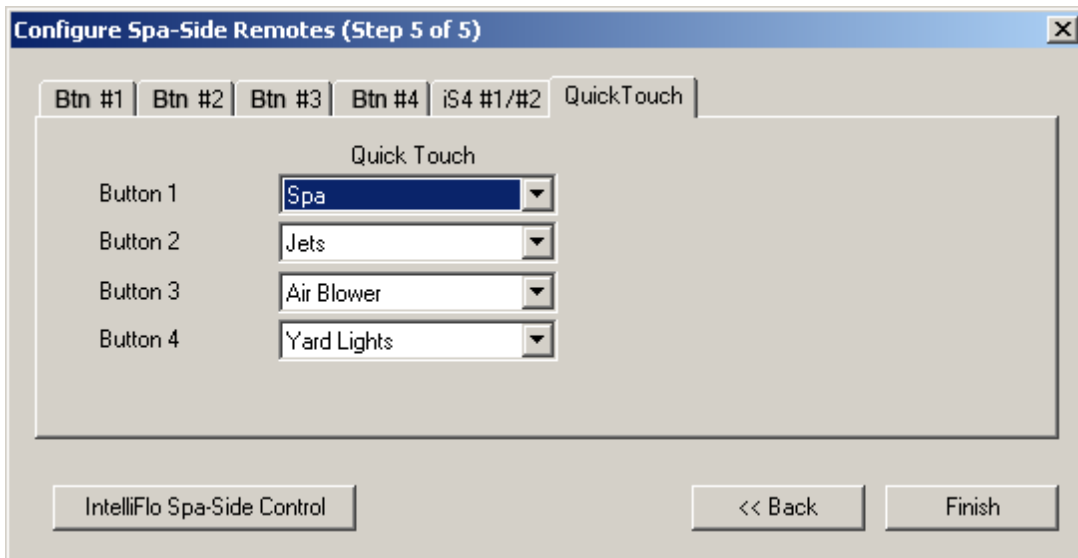



# Using the ScreenLogic2® Interface

## Section 3

### Home Screen

The Home screen can be configured to display the current time, date and weather conditions for your location as well as system information.

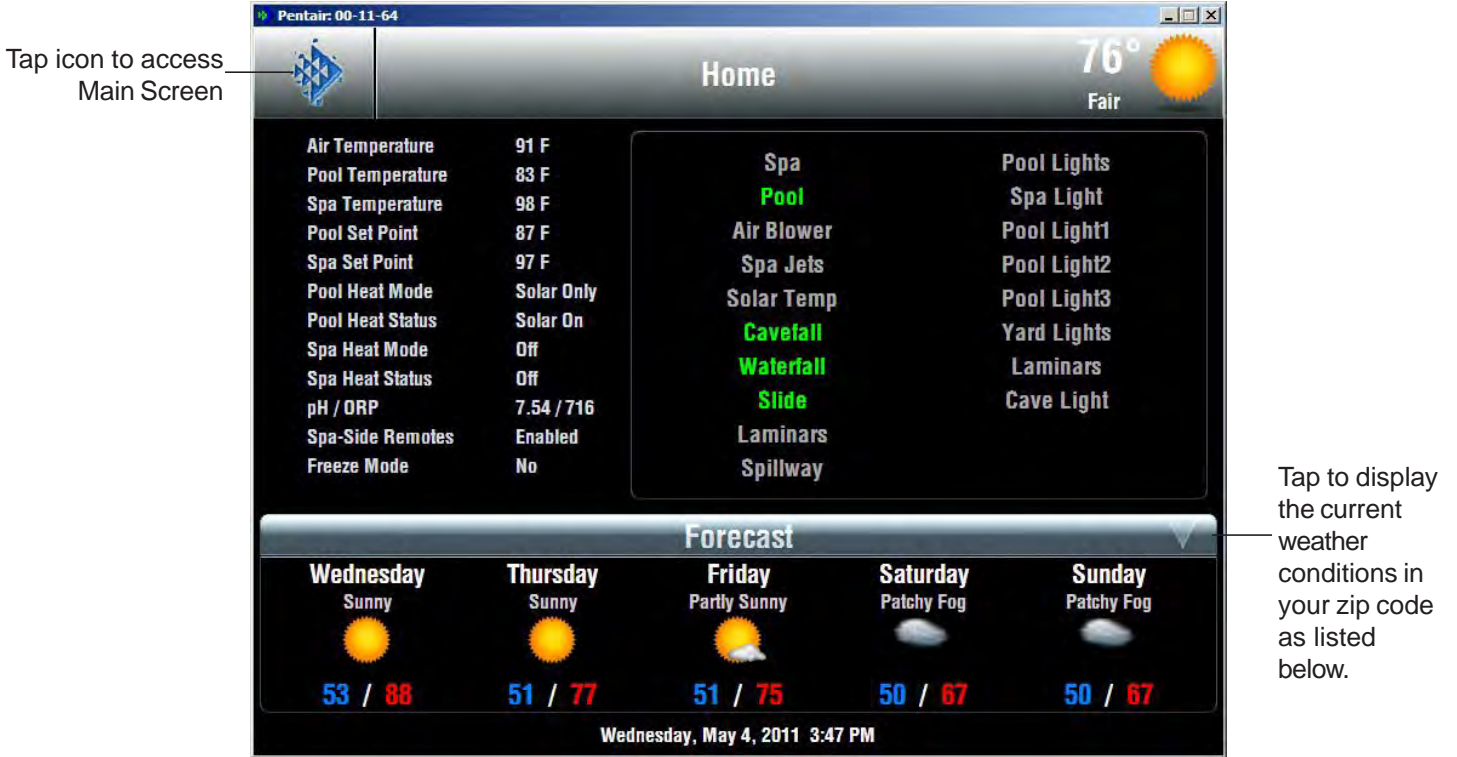

| Name                      | Description  |
|---------------------------|--|
| Current Conditions (HOME) | <p>Depending on how ScreenLogic2 is configured, the Home screen can display weather conditions for your location, or system information. These settings are configured on the "General Settings" page in the Configurator utility. See page 24 for details.</p> <p>The Home screen displays a summary of the current weather conditions for your location. ScreenLogic2 must be connected to a Broadband Internet connection to display weather conditions.</p> <p><b>Current Temp:</b> Current temperature shown in degrees in fahrenheit.<br/> <b>Wind Chill:</b> Current wind chill factor shown in degrees in fahrenheit.<br/> <b>Humidity:</b> Current humidity shown.<br/> <b>Barometer:</b> Current barometric pressure.<br/> <b>Dew Point:</b> Current dew point.<br/> <b>Visibility:</b> Current visibility shown in miles.<br/> <b>Wind:</b> Current wind direction shown in miles per hour.<br/> <b>Sunrise:</b> Current time of sunrise for your location. Location is set via Longitude and Latitude settings. See page 33 for details.<br/> <b>Sunset:</b> Current time of sunset for your location. Location is set via Longitude and Latitude settings. See page 17 for details.</p> |
| Forecast                  | <p><b>Weather pictures:</b> Displays the weather forecast with high and low temperatures.</p>  |
| Day, Month, Year and Time | <p>Displays the current day, month, year and time. See page 24 for details.</p>  |
| Blue ScreenLogic icon     | <p>Tap this tab to access the <b>Main Screen</b>.</p>  |



## Main Screen Description

### Pool/Main Tabs:

**PUMPS:** Controls for pool/spa pumps see page 64.

**SETTINGS:** Setup pool/spa schedules for filter pump, heater and lights see page 45.

**HISTORY:** View historical usage data for your pool, spa, lights and solar, see page 59.

### Pool/Main Tab:

**POOL/SPA:** Controls for your pool/spa heating, and various other circuits such as pool jet, spa jet, spillway pumps and lighting.

**FEATURES:** Controls for special water features your pool/spa. These buttons are user defined circuits. To assign circuit buttons, see "Setup Circuits," page 20.

**LIGHT:** Controls for your pool/spa and landscape lighting see page 45.

**DELAYS & ALERTS:** Displays current system delays and alerts including see page 60.

**INTELLICHEM:** Displays current pH and ORP levels. Adjust water chemistry levels from this screen, see page 63.

**CHLORINATOR:** Controls for chlorinator chlorine output. Displays current salt levels see page 63.

**Green/Grey button:** Indicates that the circuit is switched **On**. A grey button indicates that the circuit is switched **Off**. Tap the button to switch a circuit on, then tap it again to switch it off.

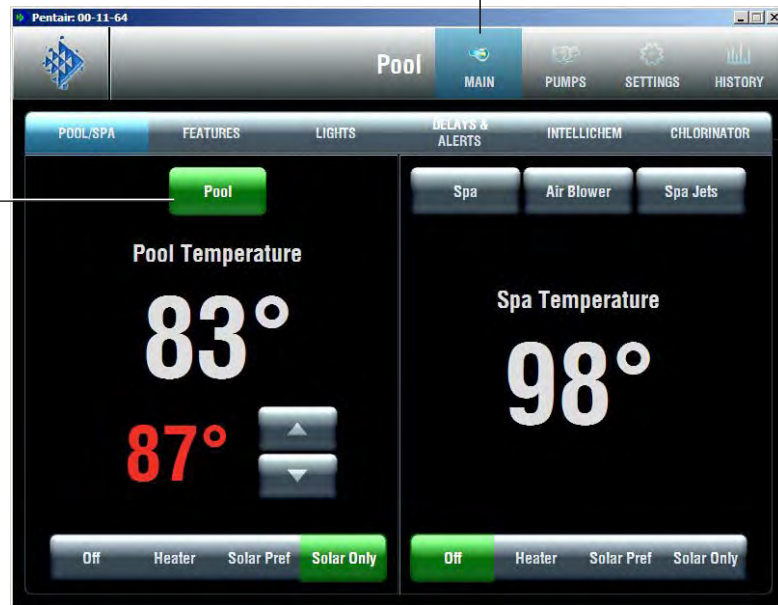

**Pool control button:** Switches on Filter Pump and fires heater. Shared equipment systems (i5, i7+3, i9+3); rotates valves to pool position.

**For shared equipment:** When both Heat Mode buttons for the pool and spa are set to on, if the Pool button is switched on, the Spa button is off. The Heat Status display indicates that heat is switched off to the spa while it is being used to heat the pool. This button by default is always displayed on the Main tab.

To assign circuit buttons, see "Setup Circuits," page 20.

**Spa heat controls:** The Heat Mode switches control of the current heat source being used.

**Spa and Pool Temperature (actual Temperature)** Displays (in white) the current temperature of the pool/spa water via the water temperature sensor.

**Spa Set Point (in red)** Displays the current temperature that the heater is set to. Use the Up/Down button to adjust the Spa set point temperature.

**Spa control buttons:** For shared (i5, i7+3, i9+3) and dual (i10+3D) equipment systems; switches on filter pump, rotate valve actuator (to isolate spa water from pool water), and fires heater.

## Main Screen Description (Continued)

The Pool/Spa **Main** screen displays the main control buttons for the pool, spa, and user defined water features.

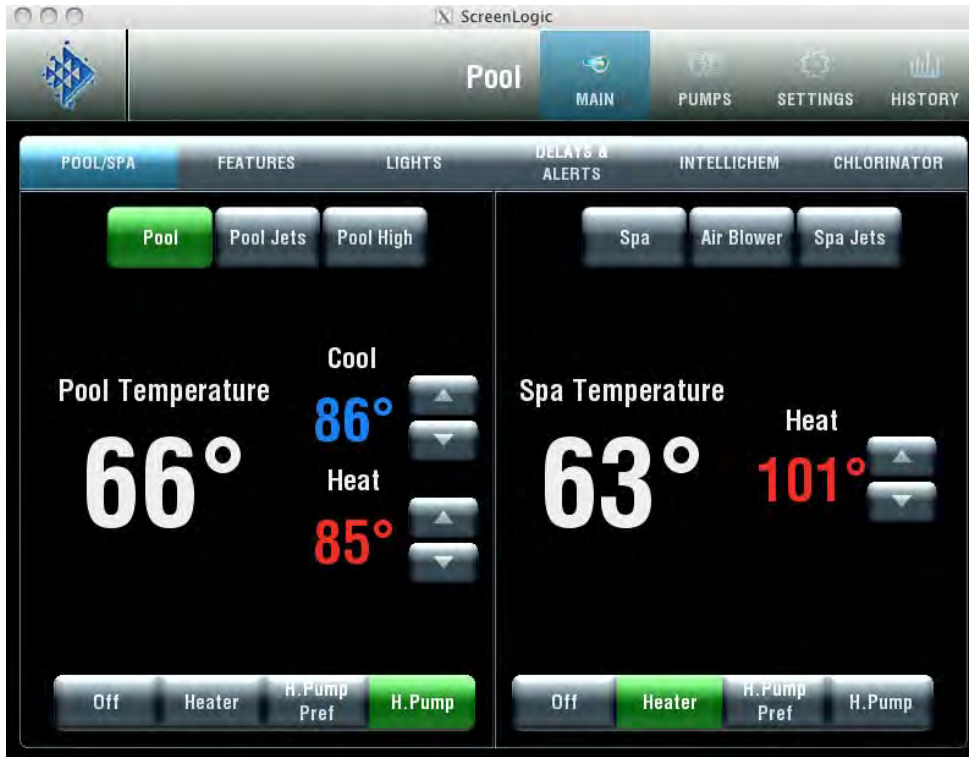

Heat Pump interface with cooling option

| Name                    | Description   |
|-------------------------|---|
| Pool/Spa/Water Features | <p>Displayed circuit buttons are user assigned as configured in the Configurator utility. For more information about configuring ScreenLogic, refer to page 15. User defined circuit names can be assigned to any of the displayed buttons. For more information about displaying buttons on the main screen, refer to “Setup circuits (Step 2 of 5),” page 20 and “Display a Circuit Function Button on the Main Screen,” page 27.</p> <p><b>Pool/Spa buttons:</b> Use the Pool and Spa buttons to switch on the pool filter pump and heater (if Spa manual heat is enabled). For shared equipment systems (i5, i7+3 and i9+3); rotates valves to the pool position.</p> <p><b>Heat Mode buttons:</b> Use these buttons to select the heat source. The selections are:</p> <ul style="list-style-type: none"> <li>▫ <b>Off:</b> Switch off heat source.</li> <li>▫ <b>Heater:</b> Pool heater is enabled.</li> <li>▫ <b>Solar Preferred or Heat Pump Preferred:</b> If heat can be gained,, use solar heat source. Otherwise use heat pump.</li> <li>▫ <b>Solar or Heat Pump:</b> Select Solar or Heat pump as the heat source.</li> </ul> <p><b>Heat Status:</b> Displays the current heat source being used. Also indicates when the heat source is switched off.</p> <p><b>Up arrow button:</b> Raise the set point pool temperature.</p> <p><b>Down arrow button:</b> Lower the set point pool temperature.</p> <p><b>Actual Pool Spa Temperature:</b> Displays the current pool temperature (in white).</p> <p><b>Set Point (in red):</b> Current pool temperature set point as set by the Warmer and Cooler buttons.</p> |

## Main Screen (Continued)

### Configuring Pool and Spa Heating System Options

The IntelliTouch® Control System allows for many different pool and spa heating options. In some instances, more than one heating system may be installed. The system can then automatically select the heating system that is most effective for your settings. However, before the system can take advantage of these options the system must be told what kind of heating systems are installed.

To configure the heating system options for your pool or spa, use the **Heat Mode** button.

1. From the ScreenLogic2 Interface main screen, on the **Pool Spa** screen, tap a **Heat Mode** button to select the type of heat option to use. The Heat Mode choices are:
  - **OFF:** No heating even though pump and other circuits may be operating.
  - **HEATER:** Use the gas heater only.
  - **SOLAR PREF. or HEAT PUMP PREF. -** Solar Preferred is used when solar and gas heating are available, and you want to use solar heating only when it is most effective. Heat Pump Pref. is displayed if solar is set up as a Heat pump (see page 36),
  - **SOLAR or HEAT PUMP:** Solar is used when solar heating system is the only heat source.
2. To activate a heat source, tap the **Heater** or **Solar** button. To switch off the heater, tap the **Off** button.
3. Tap **Finish** when done.

## Change the Pool and Spa Temperature

All pool and spa heat modes and temperature controls are located on the Main screen. The pool or spa will heat to the settings specified on this screen.

### Changing Pool Heat Settings

To raise the pool water temperature:

1. From the Main Pool/Spa screen choose Heater, Solar Preferred or Solar in the **Heat Mode** selection.
2. Tap the **Up arrow button** for the pool temperature. The pool will heat to the settings specified as indicated by the Set Point.

To lower the pool water temperature:

- Tap the **Off** button for **Heat Mode** or tap the **Down arrow button** to program a new Set Point temperature.

### Changing Spa Heat Settings

To raise the Spa water temperature:

1. From the main screen choose Heater, Solar Preferred or Solar in the **Spa Heat Mode** selection.
2. Tap the spa **Up arrow button**. The pool will heat to the settings specified as indicated by the Set Point.

To lower the spa water temperature:

- Tap the **Off** button for **Heat Mode** or tap the **Down arrow button** to change the new Set Point temperature.

## Main Lights Screen

From the COLOR LIGHTS and INTELLIBRITE tabs you can control standard pool and landscape lights and IntelliBrite® LED Lights which are displayed on the main **Lights** screen. For lights to display on the main lights screen, circuits must first be assigned as “lights” in the “Setup Circuits (Step 2 of 5)” page of the Configurator utility (see page 20).

A combination of standard and IntelliBrite lights can be controlled from both the “Color Lights” and “IntelliBrite” tabs. For example, you might have two Pentair *SAm* lights, two IntelliBrite LED lights in your pool/spa. These lights can be controlled from the **Lights** screen using the special **Color Set**, **Color Swim** and **Color Sync** lighting features in the “Color Lights” tab or control the IntelliBrite lights from the “IntelliBrite” tab to select fixed colors or a color show mode.

## Color Lights Tab

For lights to display in the Color Lights screen, and for the Special Lights buttons to work, you must first assign the light in the Special Lights area. For more information, refer to Setup Circuits (Step 2 of 5), page 20. From the Lights screen you can switch lights on or off and dim selected incandescent lights. Pentair SAM®, SAL® and IntelliBrite® lights cannot be dimmed. Before lights can be dimmed a qualified electrician must wire them with the IntelliTouch Control system Dimmer Module (P/N 520406) in the Load Center. Only incandescent tungsten filament lights may be dimmed (Halogen lights cannot be dimmed). Before a light is displayed on this screen, circuits must first be assigned as a light in the “Setup Circuits” page of the Configurator utility. The light circuit name must be assigned a dimmer circuit function. To assign a circuit function, see “Assign a Circuit Name and Function,” page 23.

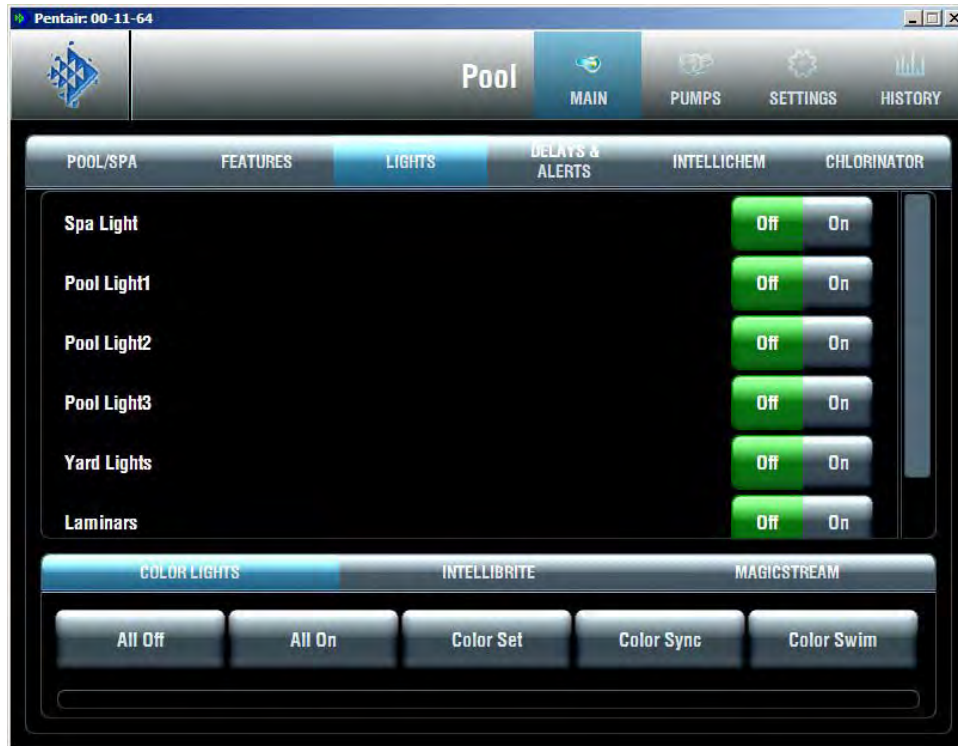

| Name   | Description  |
|--------|--|
| Lights | <p>This screen can display up to 40 assigned lights.</p> <p>The following are examples of different lights that can displayed in the Lights screen. To dim a selected light, select a dimming percent value button from 30% to 100%.</p> <p><b>Spa Light:</b> Select the Off button to switch the light off. In order to use the "Special Lights" buttons (IntelliBrite, Sam, Sal, Color Wheel), the light must be assigned in the "Special Lights" dialog (see page 20) .</p> <p><b>Pool Light1:</b> Select the Off button to switch the light off. In order to use the "Special Lights" buttons, the light must be assigned in the "Special Lights" dialog (see page 20) .</p> <p><b>Pool Light2:</b> Select the All Off or All On button to switch the light off or press the OFF button. In order to use the "Special Lights" buttons, the light must be assigned in the "Special Lights" dialog (see page 20) .</p> <p><b>Pool Light3:</b> Select the All Off or All On button to switch the light off. In order to use the "Special Lights" buttons, the light must be assigned in the "Special Lights" dialog (see page 20).</p> <p><b>Yard Lights:</b> Select the Off button to switch the light off.</p> <p><b>Laminars:</b> Select the Off button to switch the light off.</p> |

## Lights Screen (Continued)

| Name                   | Description   |
|------------------------|---|
| Color Lights           | Displays assigned light circuits names and Off/On buttons.  |
| IntelliBrite           | Displays assigned IntelliBrite lights and Off/On buttons.   |
| MagicStream            | Displays assigned MagicStream laminars circuits and Off/On buttons.   |
| Special Lights Buttons | <p>For lights to display in this screen, and for the Special Lights buttons to work, you must first assign the light in the Special Lights dialog. For more information, refer to Setup Circuits (Step 2 of 5), page 20.</p> <p><b>All Off:</b> Switches off all lights that have been assigned in the Special Lights dialog in step 2 of the Configurator utility.</p> <p><b>All On:</b> Switches off all lights that have been assigned in the Special Lights dialog.</p> <p><b>Color Set:</b> Switches on all SAM, SAL, and FIBERworks lights that have been assigned in the Special Lights dialog.</p> <p><b>Color Sync:</b> Activates the Color Sync feature for all SAM, SAL, and Fiberworks lights that have been assigned in the Special Lights Dialog.</p> <p><b>Color Swim:</b> Activates the Color Swim feature for all SAM, SAL, and Fiberworks lights that have been assigned in the Special Lights dialog.</p> <p><b>Color Mode Status Bar:</b> The red bar indicates the activation status and current completion time. Activating the Color Set, Color Sync, or Color Swim features is not immediate, it can take up to one minute for the process to complete.</p> |

## Dim Lights

Lights that have dimming functionality can be dimmed from the Lights screen. Only incandescent tungsten filament lights may be dimmed. *SAM*<sup>®</sup>, *SAL*<sup>®</sup>, *IntelliBrite*<sup>®</sup>, Fiber-optic, or Halogen lights cannot be dimmed. The feature circuit must be assigned a dimmer circuit function. To assign a circuit function, see “Assign a Circuit Name and Function,” page 23. In order to dim lights, the Dimmer Module (P/N 520406) must be installed by a qualified electrician in the Load Center.

To dim lights:

1. From the Main screen, tap the **Lights** tab.
2. Tap one of the Dimmer buttons to set the dimming level for the light. Dimmer percent values are from 30% to 100%. The light will adjust to the set dimming level.

**Note:** *Macros can turn on light dimming circuits, but lights cannot be dimmed through the macro. The dimming level must be changed for each light dimming circuit.*



## Special Lighting Features

If you have at least one Pentair *SAM*® and/or *SAL*® or IntelliBrite®, and/or *FIBERworks*® lighting systems, you can use the special **Color Set**, **Color Swim** and **Color Sync** lighting features to change the lighting settings. For IntelliTouch® Control Systems, up to 12 of these light systems can be independently controlled from the **Lights** screen. Note: The EasyTouch® Control System support 8 lights maximum.

The Color Swim feature creates the illusion of bands of color moving through the water by switching on each light with a specific color in a specified order and at different time intervals. You can customize the Color Swim feature lighting effect by offsetting the delay time between the various installed Pentair colored lights. The order and time delay between lights can be mixed and matched to create many different effects. For example, colors moving left to right, one body of water to another, from the middle outward, etc. Once programmed all these effects work at the touch of a button. The Color Swim circuit must have its own relay and separate circuit.

The special light features are:

- **Color Set** - The IntelliTouch control system allows a combination of up to 12 *SAM*, *SAL*, IntelliBrite or *FIBERworks* lighting circuits (EasyTouch control system supports 8 lights maximum) to be preset to specific colors. Each light must have its own relay and separate circuits.
- **Color Sync** - Causes all color changing lights to synchronize their colors.
- **Color Swim** - The IntelliTouch control system allows a combination of up to twelve *SAM*, *SAL*, IntelliBrite, or *FIBERworks* lighting circuits to be preset to transition through colors in sequence (EasyTouch control system supports 8 lights maximum). Each light must have its own relay and separate circuits. The Swimming Colors or Color Swim feature creates the illusion of bands of color moving through the water by switching on each light with a specific color in a specified order and at different time intervals. The order and time delay between lights can be mixed and matched to create many different effects. For example, colors moving left to right, one body of water to another, from the middle outward, etc.

Before you start, check the following:

- The **AUX** circuits that control your lighting have been assigned names and one of these lighting circuit functions: Light, IntelliBrite, Color Wheel, Photon Generator, *SAM* light, *SAL* light, IntelliBrite or Dimmer.
- Make sure that your *SAM*, *SAL* lights have been set up in **Circuit Functions** as *SAM* and *SAL* lights.
- Make sure that your IntelliBrite lights have been set up in **Circuit Functions** as IntelliBrite lights.
- Make sure to assign each colored lights in the appropriate position in the Configurator utility (see Setup Circuits (2 of 5), page 20).
- Make sure that any light you want to be controlled by the All on, All off, Color Sync, Color Set, and Color Swim feature are assigned in the “Special Lights” dialog in the Configurator utility (see page 20).
- If your system has *FIBERworks* lighting, it must be setup as a “Photon Generator” for the circuit controlling the light bulb and “Color Wheel” for the circuit controlling the color wheel. These setup steps are usually done by the installer. For details, refer to see “Assign a Circuit Name and Function,” page 23.



## Lights Screen: Configure Set Colors Tab (Color Set)

The Configure Set Colors screen displays color selection, and control modes for the Pentair IntelliBrite®, SAM®, SAL®, and FIBERworks® color lights. Before IntelliBrite, SAM and SAL lights display on this screen, circuits must first be assigned in the “Setup Circuits” page of the Configurator utility, then selected in the “Special Lights” dialog. For more information, refer to “Set Circuits (Step 2 of 5),” page 20.



| Name                 | Description  |
|----------------------|--|
| Configure Set Colors | <p>The screen example shows the selected colors used by "Swimming Colors."</p> <p><b>Pool Light 1:</b> Select colors to use for pool SAM or IntelliBrite lights.</p> <p><b>Pool Light 2:</b> Select colors to use for pool SAM or IntelliBrite lights.</p>   |
| Special Lights       | <p>For lights to display in this screen, and for the Special Lights buttons to work, you must first assign the light in the Special Lights dialog. For more information, refer to Set Circuits (Step 2 of 5), page 20.</p> <p><b>All Off:</b> Switches off all lights shown on the Lights page.</p> <p><b>All On:</b> Switches on all lights shown on the Lights page.</p> <p><b>Color Set:</b> Switches on all Color Set IntelliBrite, SAM, SAL, and Fiberworks lights.</p> <p><b>Color Sync:</b> Activates the Color Sync feature for all IntelliBrite, SAM SAL, and Fiberworks lights.</p> <p><b>Color Swim:</b> Activates the Color Swim feature for all IntelliBrite, SAM, SAL and Fiberworks lights.</p> <p><b>Color Mode Status Bar:</b> The red bar indicates the activation status and current completion time. Switching lights on or off, or activating the Color Set, Color Sync, or Color Swim features is not immediate, it can take up to one minute to complete.</p> |

## Lights Screen: Configure Swimming Colors Tab (Continued)

Before *SAM*®, *SAL*®, or *IntelliBrite*® Lights display on this screen, circuits must first be assigned in the “Setup Circuits” page of the Configurator utility, then selected in the “Special Lights” dialog. For more information, refer to “Set Circuits (Step 2 of 5),” page 207.

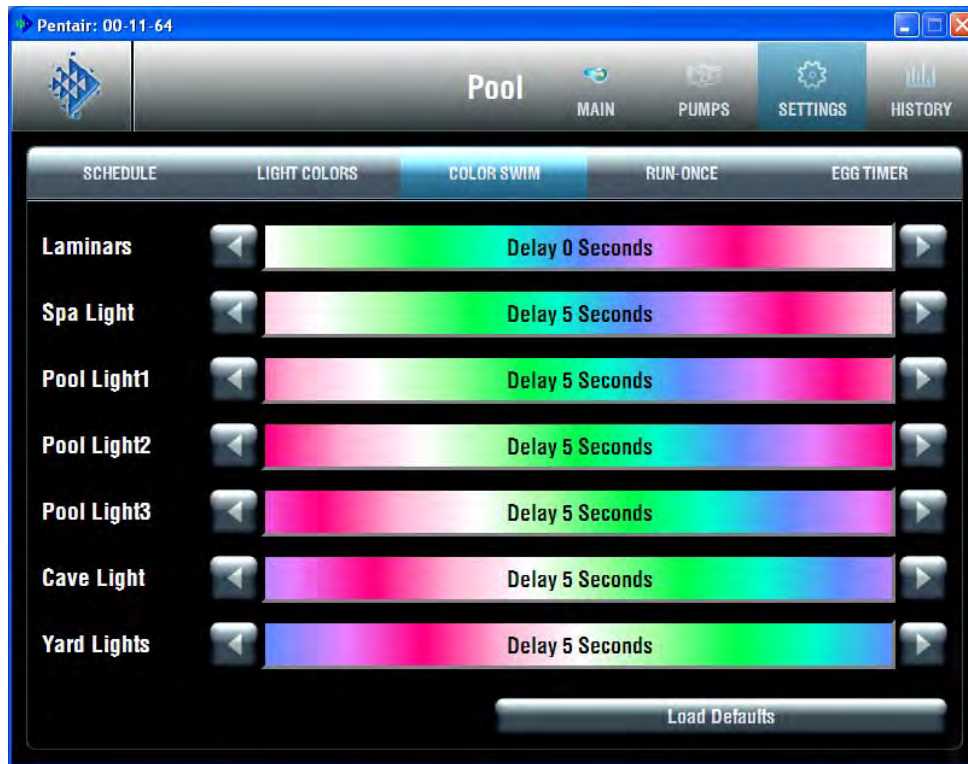

| Name                  | Description  |
|-----------------------|--|
| Configure Colors Swim | <p><b>Pool Light1:</b> Use the side arrow buttons to increase or decrease the delay time in seconds, between the Pool Light 1 and Pool Light 2 lights.</p> <p><b>Pool Light2:</b> Use the side arrow buttons to increase or decrease the delay time in seconds, between the Pool Light 1 and Pool Light 2 lights.</p> <p><b>Load Default button:</b> Resets the current lights delay time to 5 seconds between all lights.</p>   |
| Special Lights        | <p>For lights to display in this screen, and for the Special Lights buttons to work, you must first assign the light in the Special Lights dialog. For more information, refer to Set Circuits (Step 2 of 5), page 27.</p> <p><b>All Off:</b> Switches off all IntelliBrite, SAM, SAL, and Fiberworks lights.</p> <p><b>All On:</b> Switches on all IntelliBrite SAM, SAL, and Fiberworks lights.</p> <p><b>Color Set:</b> Switches on all Color Set IntelliBrite SAM, SAL, and Fiberworks lights.</p> <p><b>Color Sync:</b> Activates the Color Sync feature for all IntelliBrite, SAM, SAL, and Fiberworks lights.</p> <p><b>Color Swim:</b> Activates the Color Swim feature for all IntelliBrite, SAM, SAL, and Fiberworks lights.</p> <p><b>Color Mode Status Bar:</b> The red bar indicates the activation status and current completion time. Switching lights on or off, or activating the Color Set, Color Sync, or Color Swim features is not immediate, it can take up to one minute to complete.</p> |

## Color Set Lighting Feature

The Color Set feature allows any combination of up to 12 SAM®, SAL®, IntelliBrite®, or FIBERworks® lighting circuits to be preset to specific colors. This feature requires at least one SAM, SAL, IntelliBrite, or FIBERworks lighting product controlled by separate AUX circuits.

To set up Color Set lights:

1. From the Main screen, tap the **Lights** tab.
2. Tap the **Configure Colors** tab.
3. Tap the color for SAM, SAL, IntelliBrite, or FIBERworks lights. Each, then tap the **Color Set** button to preset the lights to the selected color. The Special Lights bar indicates the progress.
4. Tap the **Main** tab when finished to return to the main screen.

## Set up Swimming Colors (Color Swim)

This feature requires at least one SAM, SAL, IntelliBrite, or FIBERworks lighting product be controlled by separate AUX circuits.

To set up Swimming Colors lights:

1. From the main screen, tap the **Lights** tab.
2. Tap the **Configure Colors** tab.
3. Tap the **Configure Color Swim** tab.
4. Select a displayed pool or spa light. Tap either of the side arrows to set delay time between the lights. To achieve different swimming color effects, try setting **Pool Light 1** light to 0 seconds, then set Pool Light 2 to 16 seconds. Set a higher delay time for lights that are spread further apart. Use the **Load Defaults** button to reset the delay time to 5 seconds between all lights.
5. Tap **Color Swim** to activate the swimming color feature. The Special Lights bar indicates the progress.

***Note:** It may take up to a minute or more for Color Swim, or Color Sync to function as programmed depending on what kind of light you are activating and what state it was in when the effect was activated. The displayed red bar under the Special Lights buttons, indicates the progress.*

## Color Sync

This feature switches all *SAm*<sup>®</sup>, *SAL*<sup>®</sup>, *IntelliBrite*<sup>®</sup> and *FIBERworks*<sup>®</sup> colored lights on and synchronizes the lights.

To synchronize lights:

1. From the Main screen, tap the **Lights** tab.
2. Tap the **Color Sync** button to activate all color changing lights to synchronize with each other. The process may take up to a minute. The displayed red bar indicates the progress.

## Switching Lights All on/All off

For lights to display in the Lights screen and to be activated by the All On, All Off, Color Sync, Color Set and Color Swim they must be assigned in the “Special Lights” dialog (see page 47). If a light circuit is not assigned in the “Special Lights” dialog, it can still be displayed in the Lights screen, and individually switched on or off using the light button. Depending on your IntelliTouch<sup>®</sup> Control System, there can be up to 40 lights that can be accessed from the Lights screen. You can also set up the Color Set, Color Swim and Color Sync special lighting features. Typically there is a minimum of three Pentair IntelliBrite, *SAm* or *SAL* lights installed in the pool and spa in order to achieve the desired effects.

To manually switch on lights for your pool, spa and other outdoor lights:

1. From the main screen, tap the **Lights** tab.
2. **To switch individual lights on or off:** Choose the light to switch off or on, then tap the appropriate **On** or **Off** button.
3. **To switch all lights on or off:** Tap the **All Off** or **All On** button.

## Lights Screen: IntelliBrite® Lights

Before the configured IntelliBrite lights display on this screen, circuits must first be assigned in the “Setup Circuits (Step 2 of 5)” dialog of the Configurator utility, then selected in the “Special Lights” dialog. For more information, refer to “Set Circuits (Step 2 of 5),” page 20.

Using the IntelliBrite buttons, you can select color show modes or fixed colors, and recall a previously captured custom color. There can be up to 12 IntelliBrite light circuits on the main **Lights** screen. Each IntelliBrite light must have its own relay and separate circuit.

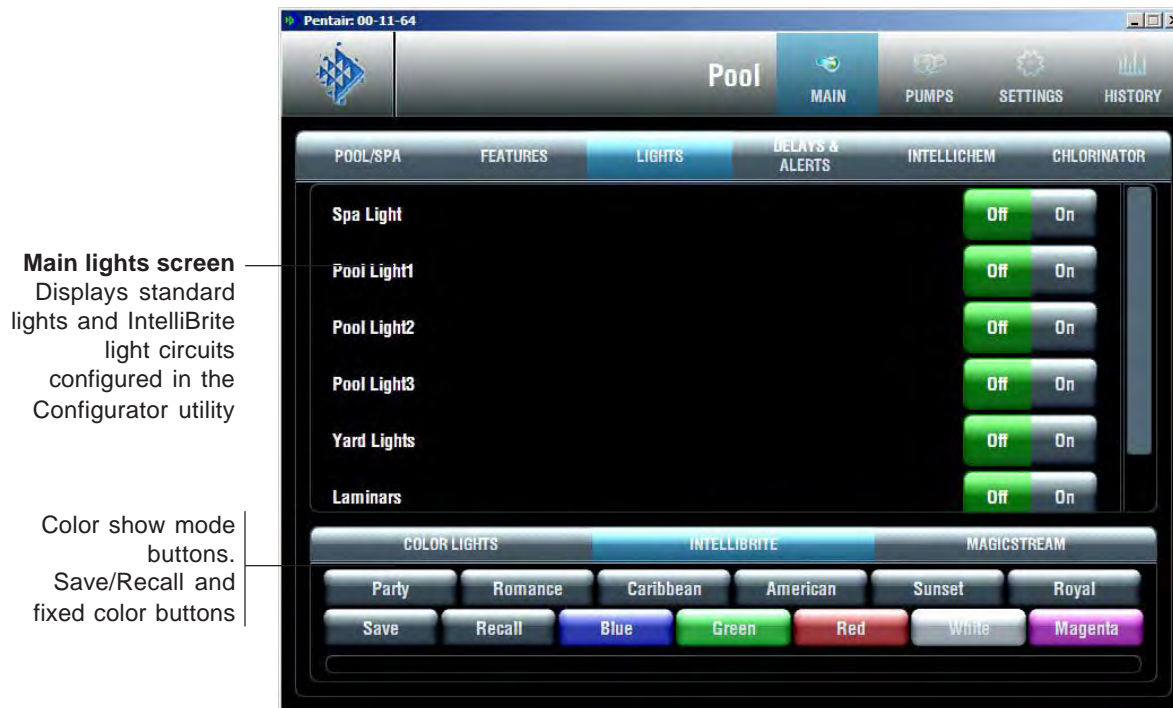

### Color light show and fixed color buttons

Choose one of the six pre-programmed color light show modes or five fixed colors.

**Party Mode:** Rapid color changing building energy and excitement.

**Romance Mode:** Slow color transitions creating a mesmerizing and calming effect.

**California Sunset Mode:** Dramatic transitions of orange, red and magenta tones.

**American Mode:** Patriotic red, white and blue transition.

**Caribbean Mode:** Transitions between a variety of blues and greens.

**Royal Mode:** Richer, deeper color tones.

**Blue:** Fixed color.

**Green:** Fixed color.

**Red:** Fixed color.

**White:** Fixed color.

**Magenta:** Fixed color.

### Save and Recall buttons

Use the Save and Recall buttons to capture a unique color effect and recall it at a later time.

**Save button:** Press this button to save the current colors while a color light show is active.

**Recall button:** Press this button to activate the last saved unique colors.



## Schedule Screen

From the Schedule screen you can schedule when to switch on and off lights, heater, spa jets, and the filter pump. You can also schedule which heat mode to use and also change the heat set point if necessary.



### Name

### Description

Options - Left/Right Arrows

**Circuit:** Name of the circuit to use in schedule. Use the side arrows to select the desired circuit.

**Start Time:** Scheduled start time. Use the side arrows to select the time when the circuit is to be switched on.

**Stop Time:** Scheduled stop time. Use the side arrows to select the time when the circuit is to be switched off.

**Heat Command:** The heat mode options are: Don't Change (default), Off, H.Pump Only, H.Pump Preferred, and Heater. If "Solar present" is selected (see page 36 the options are, Don't Change, Off, Solar Only, and Solar Preferred. Use the "Don't Change" option to use the currently selected Heat Mode option on the Main screen. Use the side arrows to select the heat mode.

**Change Heat Set Point:** Options are: Use Manual Setting (default), and Yes. Use the side arrows to select the options. To change the existing heat set point select "Yes" and change the new set point in "Heat Set Point" option.

**Heat Set Point:** This option displays if "Yes" is selected in "Change Heat Set Point." Tap either side arrow to set the new heat set point.

**SmartStart:** Select "Yes" to enable the option. This option displays when a SAM or SAL light circuit is selected in the Circuit option. If the SAM or SAL circuit was assigned a color changing light Circuit Function, when the light is switched on, the light will automatically begin changing colors.

**Days to run:** Select the days of the week to schedule the current circuits.

Add/Delete Program buttons

**Add Program button:** Use this button to display a new schedule and to access schedule options.

**Delete Program button:** To delete a scheduled program, select the program to delete from the list, then tap the **Delete Program** button.

## Schedule Feature

Use the Schedule feature to program when you want to automatically run equipment such as pool filtration or lights. Any circuit (auxiliary, feature, or macro) can be set to switch on and off for all days of the week, or for individual days. For the IntelliTouch® Control System, up to 99 programs may be created for all circuits combined. For the EasyTouch® Control System, 12 programs may be created for all circuits combined.

The following describes how to schedule a daily program:

To program the daily timed circuits

1. From the main screen, tap the **Schedule** tab.
2. Tap **Add Program** to add a new schedule.
3. **Assign a circuit:** Tap either side arrow to scroll through the available circuits. Select the circuit to schedule. Pool and spa circuits are grouped in the status list.
4. **Set the start time:** Tap either side arrow to set the hour for the start time.
5. **Set the stop time:** Tap either side arrow to set the hour for the stop time.
6. **Heat Command:** Tap either side arrow to set heat mode. The options are Don't Change (default), Off, H.Pump Only, H.Pump Preferred, and Heater. If "Solar present" is selected (see page 36) the options are, Don't Change, Off, Solar Only, and Solar Preferred. Use the ""Don't Change"" option to use the currently selected Heat Mode option on the Main screen. Use the side arrows to select the heat mode.
7. **Change Heat Set Point:** Options are: Use Manual Setting (default), and Yes. Use the side arrows to select the options. To change the existing heat set point select "Yes" and change the new set point in "Heat Set Point" option.
8. **Heat Set Point:** This option displays if "Yes" is selected in "Change Heat Set Point." Tap either side arrow to set the new heat set point.
9. **SmartStart:** Select "Yes" to enable the option. This option displays when a *SAM* or *SAL* light circuit is selected in the Circuit option. If the *SAM* or *SAL* circuit was assigned a color changing light Circuit Function, when it is switched on in the Lights screen, the color lights will automatically begin changing colors.
10. **Days:** To set the timer to work only on certain days, tap the days of the week to run the schedule. Tap **All** to run the schedule for all the days of the week.
11. To create another schedule, tap **Add Program**.
12. **To delete a schedule:** Select the schedule to delete from the list, and tap **Delete Program**.

*Note: If the Manual Operation Priority feature is enabled during a scheduled run time, the scheduled run time is reset to 12 hours (default). For more information about the General Settings option "Manual OP Priority," see page 17.*



## Schedule: Run Once Screen

The “Run Once” feature enables you to automatically switch equipment on for one time. For example, you can pre-program your spa to start heating every Sunday on 10 AM to 10 PM.

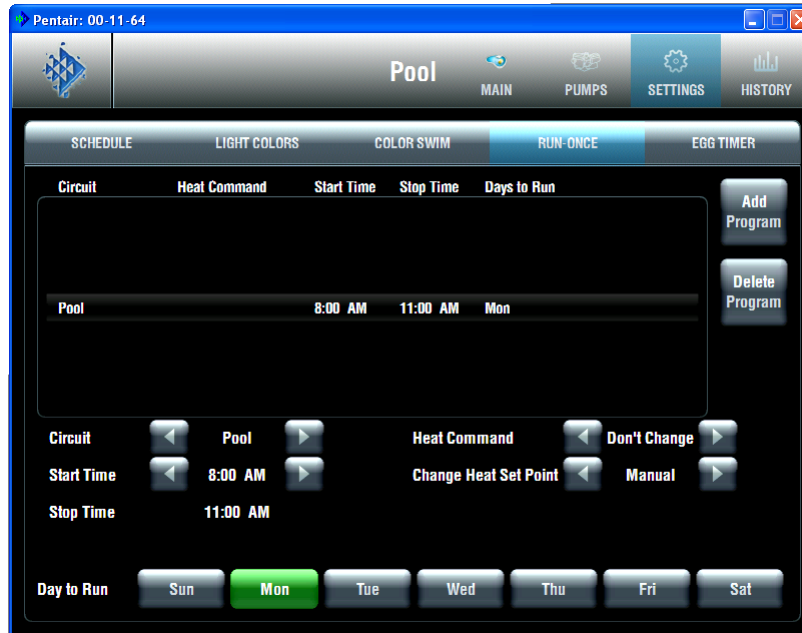

### Name

### Description

**Circuit:** Name of the circuit to use in schedule. Use the side arrows to select the desired circuit.

**Start Time:** Scheduled start time. Use the side arrows to select the time when the circuit is to be switched on.

**Stop Time:** Scheduled stop time. Use the side arrows to select the time when the circuit is to be switched off.

**Heat Command:** The heat mode options are: Don't Change (default), Off, H.Pump Only, H.Pump Preferred, and Heater. If Solar present is selected (see page 36) the options are, Don't Change, Off, Solar Only, and Solar Preferred. Use the Don't Change option to use the currently selected Heat Mode option on the Main screen. Use the side arrows to select the heat mode.

**Change Heat Set Point:** Options are: Use Manual Setting (default), and Yes. Use the side arrows to select the options. To change the existing heat set point select **Yes** and change the new set point in Heat Set Point option.

**Heat Set Point:** This option displays if Yes is selected in Change Heat Set Point. Tap the either side arrow to set the new heat set point.

**SmartStart:** Select Yes to enable the option. This option displays when a SAM or SAL light circuit is selected in the Circuit option. If the SAM or SAL circuit was assigned a color changing light Circuit Function, when it is switched on in the Lights screen, the color lights will automatically begin changing colors.

**Days to run:** Select the days of the week to schedule the current circuits.

### Add/Delete Program Buttons

**Add Program button:** Use this button to display a new schedule and to access schedule options.

**Delete Program button:** To delete a scheduled program, select the program to delete from the list, then tap the Delete Program button.

## Run-Once Timer

Use the Run-Once timer feature to program a circuit to automatically switch equipment on for one time. Unlike the Schedule regular timer, this once-only timer does not repeat. For example, you could set up the program to pre-heat your spa ready for your arrival. After the programmed Run-Once circuit is completed, it is automatically erased. The circuit must be turned off manually or wait for the 12 hour automatic shut off. However, the 12 hour factory shut off time can be changed by setting a new run time in the Egg Timer. See “Egg Timer Screen,” page 57.

To program a Run-Once daily timed circuit:

1. From the main screen, tap the **Schedule** tab.
2. Tap the **Run-Once** tab.
3. Tap the **Add Program** button to add a new program.
4. **Assign a circuit:** Tap either side arrow to scroll through the available circuits. Select the circuit to schedule. After you have finished configuring the programs in this screen, the pool, spa, and lights circuits will be displayed in groups in the status list (i.e., all pool programs are displayed together).
5. **Set the start time:** Tap either side arrow to set the hour for the start time.
6. **Set the stop time:** Tap either side arrow to set the hour for the stop time.
7. **Heat Command:** Tap either side arrow to set the heat mode. The options are Don't Change (default), Off, H.Pump Only, H.Pump Preferred, and Heater. If “Solar present” is selected (see page 36) the options are, Don't Change, Off, Solar Only, and Solar Preferred. Use the Don't Change option to use the currently selected Heat Mode option on the Main screen. Use the side arrows to select the heat mode.
8. **Change Heat Set Point:** Options are: Use Manual Setting (default), and Yes. Use either side arrow to select the option. To change the existing heat set point select **Yes** and change the new set point in Heat Set Point option.
9. **Heat Set Point:** This option displays if Yes is selected in Change Heat Set Point. Tap either side arrow to set the new heat set point.
10. **SmartStart:** Select **Yes** to enable the option. This option displays when a *SAM*<sup>®</sup> or *SAL*<sup>®</sup> Light circuit is selected in the Circuit option. If the SAM or SAL circuit was assigned a color changing light Circuit Function, when it is switched on in the Lights screen, the color lights will automatically begin changing colors.
11. **Days:** To set the timer to work on a particular day, tap the day to run the schedule.
12. To create another schedule, tap **Add Program**.
13. **To delete a program:** Select the program to delete from the list, and tap **Delete Program**.

**Note:** If Manual Operating Priority is enabled during a scheduled run time, the scheduled run time is reset to 12 hours (default). For more information about the General Settings option “Manual OPPriority,” see page 17.

## Schedule: Egg Timer Screen

The Egg Timer feature (count down timer) allows you to define the run time for lighting, spa, spa jets, and other circuits. Equipment can be set to be on for one minute to 23 hours 45 minutes. You can also use the “Don’t Stop” feature to override the 12 hour default switch off time, and run continuously until manually switched off.. If you have never set the timer for a specific piece of equipment, the factory default time is set to 12 hours. The factory default duration time is 12 hours. Note: If a power outage occurs during a scheduled count down, the Egg Timer feature will not switch the equipment back on.

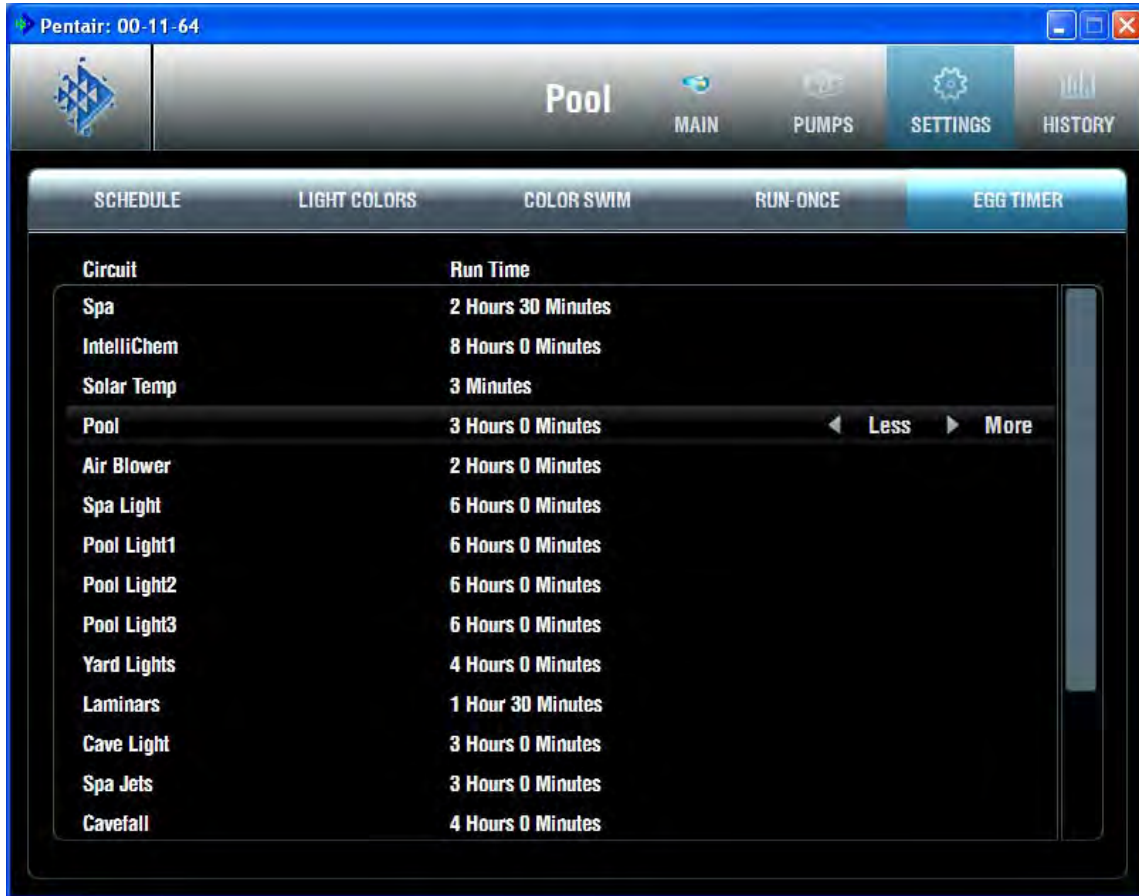

### Name

### Description

**Circuit:** Name of the circuit to use in schedule.

**Run Time:** Length of time the circuit will run when manually enabled.

< Less & > More time button

Increase or decrease the current run time. If you increase the time past 23 hours 45 minutes, Don't Stop is displayed. Use Don't Stop to run the circuit continuously.

## Setting the Egg Timer (Count Down)

The Egg Timer count down feature allows you to define the run time for different circuits. For example, whenever you manually switch your spa on, you would like it to automatically turn off in two hours. Use the Egg Timer circuit to set an automatic shut-off time. The time period can be anywhere from 1 minute to 23 hours 45 minutes. You can also use the “Don’t Stop” feature to override the 12 hour default switch off time, and run continuously until manually switched off.. If you have never set the timer for a specific piece of equipment, the factory default time is set to 12 hours. The Egg Timer is also a useful feature for turning off lighting and spa jets. For example, a jet pump can be set to turn off in 15 minutes, even when turned on by the spa-side remote control. All Egg Timer circuits are factory-set to 12 hours.

To set the Egg Timer count down:

1. From the main screen, tap the **Schedule** tab.
2. Tap the **Egg Timer** tab. A list of scheduled circuits is displayed.
3. To set a new count down time for a circuit, first select the circuit from the list. Tap the **Less Time** or **More Time** to increase or decrease the run time. The scheduled Run Time displays the time that the circuit is due to run.

To set the Don’t Stop feature:

1. From the main screen, tap the **Schedule** tab.
2. Tap the **Egg Timer** tab. A list of scheduled circuits is displayed.
3. Select the circuit from the list and tap **More Time** until the run time is increased pasted 23 hours 45 minutes. Don’t Stop will be displayed. The selected circuit is now set to run continuously.

## History Screens

The History screen displays historical usage data for your pool, spa, heater, lights, and solar, as well as pool, spa, and air temperatures. The usage information can be useful for tracking the operation and efficiency of your system.



Temperatures History Screen

pH & ORP History Screen

| Name                       | Description   |
|----------------------------|---|
| Zoom In/Zoom Out           | Use the <b>(-) Zoom Out</b> and <b>(+) Zoom In</b> button to change the time period displayed by Month, Week, Day, or Hour. Use the <b>&lt; Previous</b> and <b>Next &gt;</b> buttons to scroll through the time display.     |
| Temperature                | The Blue box corresponds to the displayed pool temperature graph line.<br>The Aqua box corresponds to the displayed spa temperature graph line.<br>The Green box corresponds to the displayed outside temperature graph line. |
| Pool/Spa/Solar/Heat/Lights | Displays the duration and actual times your equipment was operating.  |
| PH & ORP                   | Tap pH Level or ORP Level to display the following:<br>The Blue line corresponds to the pH feed graph line.<br>The Green line corresponds to the ORP feed graph line.   |

## Delays & Alerts Screen

The Delays & Alerts screen displays the current delays and alerts for the system. If a system error occurs, it is displayed on the Alerts section of the screen. The system water and air sensors are constantly monitored for errors. If a sensor error is detected, the displayed error is listed as shown below. Also, from this screen you can cancel delays that might be setup for your pool cleaner or pump. You can also Disable or Enable the Spa-side remote.

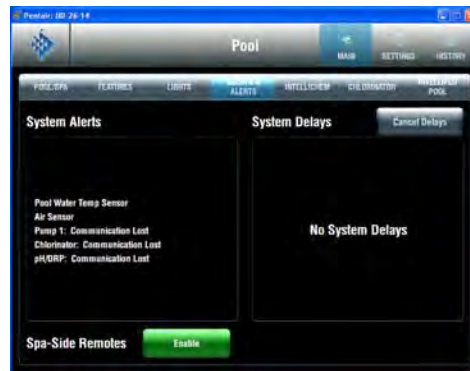

| Name             | Description  |
|------------------|--|
| System Alerts    | Displays water temperature sensor and air sensor error informaton. Also displayed is the current communication status of the pumps , chlorinator and pH & ORP equipment. If an error is detected the error message displays in yellow. |
| System Delays    | Press the Cancel Delays button to cancel the delay function for the cleaner, pool or spa. See page 61 for more information.  |
| Spa-Side Remotes | Enable/Disable SpaCommand, iS10 or iS4 spa-side remotes.   |

## Error Conditions: System, IntelliFlo Pump, IntelliChem, & IntelliChlor

### System errors:

Pool Water Temp Sensor  
Pool Solar Temp Sensor  
Air Sensor  
Spa Water Temp Sensor  
Spa Solar Temp Sensor

### IntelliFlo pump errors:

Pump 1: Filter Warning  
Pump 1: Drive Temperature Warning  
Pump 1: Priming Alarm  
Pump 1: System Blocked Alarm  
Pump 1: Unknown Alarm  
Pump 1: Drive Temperature Alarm  
Pump 1: Power Outage Alarm  
Pump 1: Over Current Alarm  
Pump 1: Over Voltage Alarm  
Pump 1: Communication Lost

### IntelliChlor SCG errors:

SCG: Low Flow Error  
SCG: Low Salt Level  
SCG: Very Low Salt  
SCG: High Current  
SCG: Clean Salt Cell  
SCG: Low Voltage  
SCG: Communication Lost

### IntelliChem Controller errors:

pH/ORP: No Flow  
pH/ORP: pH Reading Too High  
pH/ORP: pH Reading Too Low  
pH/ORP: ORP Reading Too High  
pH/ORP: ORP Reading Too Low  
pH/ORP: Check pH Tank  
pH/ORP: Check ORP Tank  
pH/ORP: Probe Check Fail  
pH/ORP: Sanitizer Feed Locked  
pH/ORP: pH Feed at Limit  
pH/ORP: ORP Feed at Limit  
pH/ORP: Invalid Hardware Config  
pH/ORP: IntelliChem Communication Error  
pH/ORP: Memory Errors  
pH/ORP: Communication Lost



## System Error Messages

If a system error occurs it is displayed on the Alerts section of the Delays & Alerts screen, see page 67.

## System Delay Cancel Feature

For convenience, on a one time basis, the Cancel Delays feature will cancel the following safety delays which can be set up in the IntelliTouch control system. Please note there is generally not a need to cancel any of these delays except for servicing or testing the system.

When the following pumps are switch on, if Pool Off Delay is selected and the Cancel Delay button is pressed, the following describes how each pump is affected:

- **Heater Cool-Down Delay Cancel:** Shuts Filter Pump off immediately.
- **Two-Speed Filter Pump 5 minute START on HIGH SPEED Delay Cancel:** Shifts pump to low speed.
- **Automatic Pool Cleaner START Delay:** Starts Cleaner Pump immediately. Normally there is a delay in which the filter pump first runs for 5 minutes before the cleaner pump starts.
- **Automatic Pool Cleaner-SOLAR Delay:** Allows Cleaner Pump to run even though solar delay has shut it off for 5 minutes.

### About the Heater Cool-down Cycle and Delay Cancel

Some heaters require a cool-down cycle before being turned off. This can be accomplished with a setup procedure in the IntelliTouch® Control System which runs the filter pump an additional ten minutes to dissipate residual heat built up inside the heater combustion chamber. The delay feature is mainly for use by service technicians when they want to shut the filter pump off immediately, and know the heater has not been running.

**IMPORTANT:** Heaters manufactured by Pentair Water Pool and Spa do not require this cool-down period and do not need the delay to be set up.

To cancel a safety delay:

From the Delays & Alerts, tap the **Cancel Delays** button.

The delay options are:

- Cleaner On Delay
- Pool Off Delay
- Spa Off Delay

## Enable/Disable Spa-Side Remotes

To disable or enable the spa-side remotes from the ScreenLogic2® Interface:

1. From the main Delays & Alerts screen, tap the **Enable** button to enable or disable the iS10 or iS4 spa-side remote.
  - Green = Enable
  - Grey = Disable

## Chlorinator Status and Control Screens

To access the Chlorinator status and controls screen:

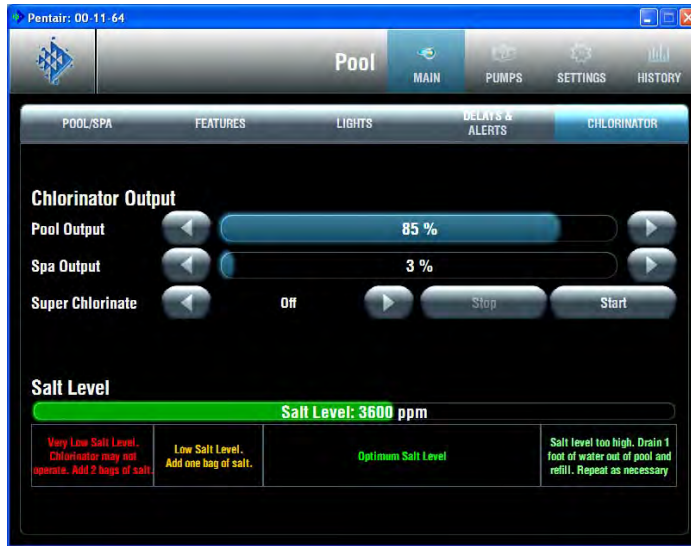

Chlorinator (IntelliChlor) screen

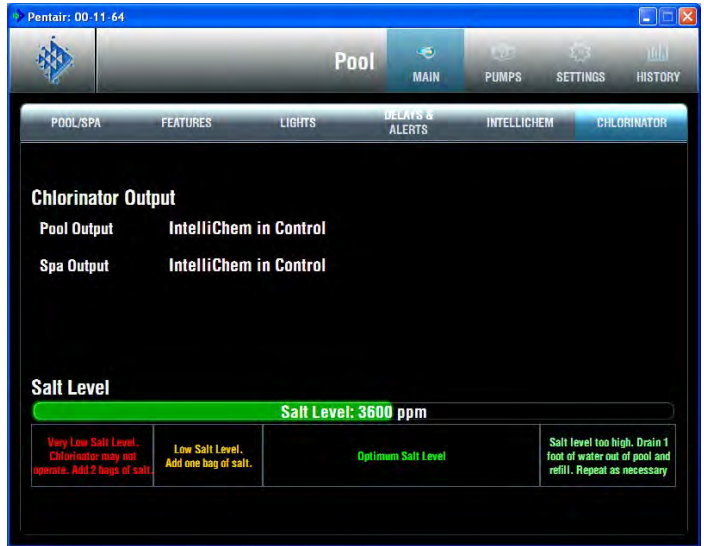

Chlorinator (IntelliChlor) with IntelliChem controller screen

From the main the ScreenLogic2® Interface screen, tap the **Main** and **Chlorinator** tab. The chlorinator screen shows:

- **Chlorinator Status:** Shows the current chlorinator operating condition. If an error is detected, the displayed error message box is highlighted in green.
- **Pool Output:** Displays the pool chlorination output level from 0 to 100%. Tap the **left** or **right** arrow to increase or decrease the pool chlorination output level. The IntelliTouch control system will automatically drop the chlorine output levels to 1/20 the output when the Spa mode is switched on. For example, if the pool output level is set to 60%, when the Spa is switched on, the chlorination output level will be 3%.
- **Spa Output:** Displays the spa chlorination output level from 0 to 100%. Tap the **left** or **right** arrow to increase or decrease the spa chlorination output level.
- **Super Chlorinate:** Tap the **Start** button to start “Super Chlorination” for 24 hours. Tap the **Stop** button to stop Super Chlorination. The default run time is 24 hours.
- **Salt Level:** Displays how much salt (in ppm: parts per million) is in the water. The color of the status bar indicates the condition of the water. Corresponding information is displayed under the status bar. Also see the chlorinator manufacturer’s instructions for recommended salt levels.

## IntelliChem® Controller Screen

From the IntelliChem® Controller screen you can control the pH and ORP values. This screen also displays the current water balance and salt levels. The Calcium Hardness, Alkalinity and Cyanuric Acid values can also be adjusted based on manual water tests to allow the water balance number to be calculated. Note: A Saturation Index value of 0 indicates the water is chemically in balance. If the Index is a minus (-) value, corrosive tendencies are indicated. If the Index is a plus (+) value, scale-forming tendencies are indicated. A Saturation Index value between +0.3 to -0.3 is considered satisfactory in a swimming pool.

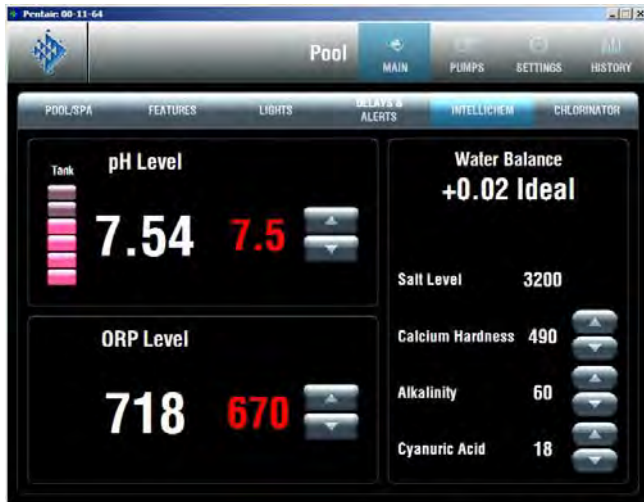

To access the pH & ORP (IntelliChem) status and control screen:

1. From the main the ScreenLogic2 Interface screen, tap the **Main** and **IntelliChem** tab to display the pH & ORP screen. The screen displays:
  - **pH Level:** Displays the current pH level. Tap the Up/Down button to adjust the pH set point value to meet pool and spa chemistry standards. The adjustable range is from 7.2 to 7.6 in increments of 0.1. The default pH set point value is 7.5.
  - **ORP Level:** Displays the current ORP level. Tap the Up/Down button to adjust the ORP set point value to meet pool and spa chemistry standards. The adjustable range is from 650 to 800 in increments of 10. The default ORP set point value is 700.

### Recommended Pool Chemistry

**Free Chlorine:** 2.0 - 4.0 ppm. Above 4.0 ppm may cause corrosion of metal components

**Combined Chlorine (Chloramines):** None (super chlorinate to remove all chloramines)

**pH:** 7.2 - 7.8 (USE MURIATIC ACID to lower pH and Soda Ash to raise pH.)

**Cyanuric Acid:** 30 - 50 ppm

**Total Alkalinity:** 80 - 120 ppm

**Calcium Hardness:** 200 - 400 ppm

**Salt:** 3000 - 4500 ppm (ideal 3400 ppm)

**Metals (Copper, Iron, Manganese):** None

**Nitrates:** None - **Phosphates:** Less than 125 ppb

**Water Balance:** The ideal water balance number should be between -0.30 and +0.30.

### Total Alkalinity

APSP's recommended ideal range for total alkalinity is 80 to 120 ppm for "gunite" and concrete pools and 125-170 ppm for painted, vinyl, and fiberglass pools. Test levels weekly and adjust according to your pool professional's recommendations. Total Alkalinity can be described as a buffer that keeps pH in order. pH depends on the ability of the total alkalinity in the water to withstand the changes in pH. If the total alkalinity is too high, adding acid (similar to pH) lowers the level. Adding a base (e.g. sodium bicarbonate) when total alkalinity is low, raises the level. The level of total alkalinity in the water is a measurement of all carbonates, bicarbonates, hydroxides, and other alkaline substances found in the pool water.

### Calcium Hardness

Recommended range for calcium hardness is 200-500 ppm. Calcium Hardness levels should be tested weekly. Calcium hardness is the calcium carbonate scale deposited on pool surfaces. The test for Calcium Hardness is a measure of how "hard" or "soft" the water is testing. "Hard" water can have high levels of calcium and magnesium. If these levels are too high the water becomes saturated and will leave calcium carbonate scale deposits (a "white-ish," crystallized rough spot) on any surface inside the pool. If the levels are too low, the water becomes "soft" and will corrode surfaces inside the pool. Use TSP or Hydroquest 100 to lower Calcium Hardness levels that are too high or add water to the pool which has a lower calcium hardness content. Levels which are too low require the addition of calcium chloride.

**Cyanuric Acid:** Cyanuric acid is needed in outdoor pools to help to stabilize and maintain proper levels of chlorine. 90% of unstabilized chlorine is destroyed by the UV radiation from the sun. Cyanuric acid stabilizes chlorine in water from UV degradation. When using the IntelliChlor SCG, the cyanuric acid level should be maintained between 30-50 ppm.

## IntelliFlo® VF Pump Screen

From the IntelliFlo VF Pump screen you can start or stop the IntelliFlo pump, adjust the GPM for each pump circuit and view the current pump error conditions. Also displayed are the IntelliFlo pump's power usage, RPM (IntelliFlo VS), GPM (IntelliFlo VF) and filter status.

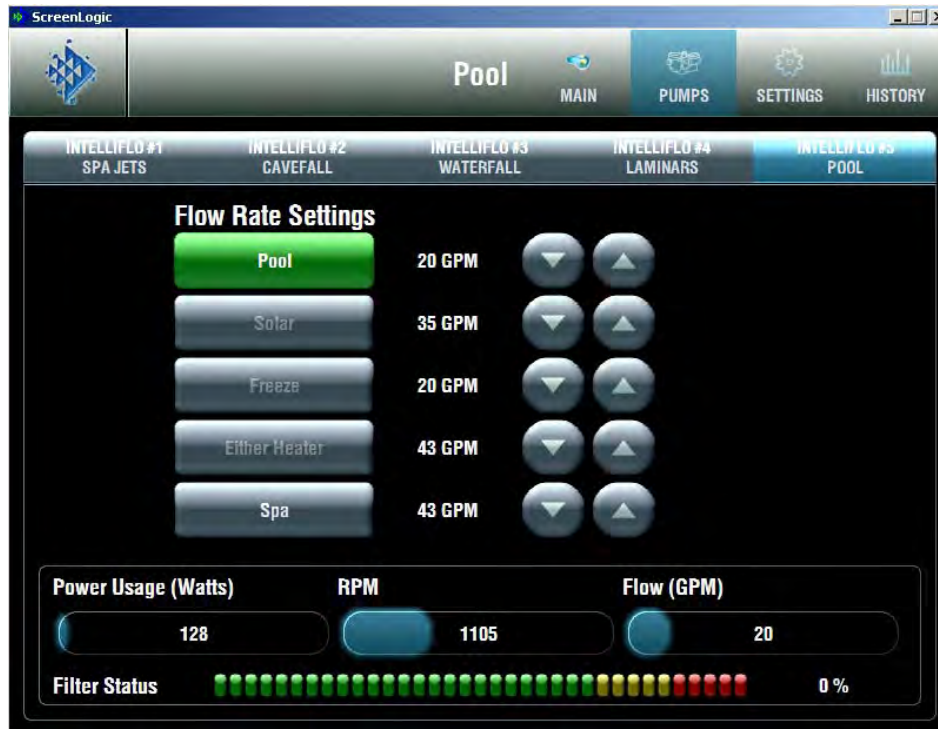

## IntelliFlo Pump Status and IntelliFlo Controls Screen

To access the IntelliFlo pump status and controls screen:

- From the main the ScreenLogic2 Interface screen, tap the **PUMPS** and **IntelliFlo #1 Pool** tab. The IntelliFlo screen displays:
  - Status:** Shows the current pump operating condition. If an alarm is detected while the pump is operating, the alarm message is displayed in green in the “Status” panel. For IntelliFlo alarm message descriptions, see “IntelliFlo VS Pump Alerts and Warnings” on page 69. For IntelliFlo VS pump alarm message descriptions, see “IntelliFlo VS Pump Alarms and Warnings” on page 81.
  - Flow Rate Settings/Buttons:** Displays the assigned pump circuits on and off buttons. These circuits are configured in the “Configurator” utility (Step 2 of 5 and 4 of 5), see pages 20 and 31. Tap the button to activate the pump circuit at the specified displayed GPM. The button will then display in green indicating the pump is active. Multiple pump circuit buttons can be active at the same time. For example, if you activate the fountain pump to run at 80 GPM, then tap the waterfall button which is set to 120 GPM, both buttons will display in green at the same time. Without stopping, the pump will ramp up from 80 to 120 GPM until it reaches 120 GPM. If you then tap the waterfall button to deactivate the circuit (button not displayed in green), the pump will ramp the GPM down to the previously set 80 GPM.
  - GPM display and Up/Down button:** Displays the current gallons per minute (GPM) for the selected pump circuit as configured in the “Configurator” utility (Step 2 of 5 and 4 of 5), see pages 27 and 31. Tap the **Up** button to increase the GPM. Tap the **Down** button to decrease the GPM. The Power Usage (Watts), RPM, and Flow (GPM) indicators display the current status while the pump is operating. If the pump is operating and you use these buttons to increase or decrease the pump's GPM flow rate, the pump will stop for approximately 10 seconds then start up again and run at the

## IntelliFlo® VF Pump Status and Controls Screen (Continued)

- **IntelliFlo Output (Pump Off/Pump On):** The **Pump Off** box is displayed in green when the pump is off and not operating. The **Pump On** box is displayed in green when the pump is operating. The Power Usage (Watts), RPM, and Flow (GPM) display the current status while the pump is operating. If the “Pump On” box displays in green and there are no buttons active on this screen (green), it indicates that the pump is operating and maybe “filtering” the pool.
- **Power Usage (Watts), RPM, and Flow (GPM) status indicators:** The pump status indicators show the current power usage in Watts, speed, in revolutions per minute (RPM), and flow, in gallons per minute (GPM) while the pump is operating.
- **Filter Status:** Displays the current percent status of the filter as set in the “Clean Filter PSI” setting for IntelliFlo VF pumps only, see page 66. Typically when the Filter Status displays 24% it indicates that the filter requires cleaning (or a Backwash). When the pump detects that the filter differential pressure (10 PSI difference) has increased and is now at the “Clean Filter” pressure, the ScreenLogic2 Interface pump status “Filter Warning” displays in green indicating that the filter must be cleaned (backwashed) to reduce the pressure. You need to stop IntelliFlo®, place IntelliTouch control system in “Service” mode, press the Start/Stop button on IntelliFlo, then press the Backwash button to start the backwash flow operation. IntelliFlo will run the preset cycle time and preset flow (GPM). The flow will be adjustable to accommodate the specific filter backwash flow requirement. After the backwash cycle is finished, the “Rinse” cycle with the preset duration time will be executed. After these cycles have been completed or if the Start/Stop button is pressed to stop the process, the filter status will be recalculated and the zero-pressure measured when Filter mode is operated again.



## IntelliFlo® VS Pump Status and Controls Screen

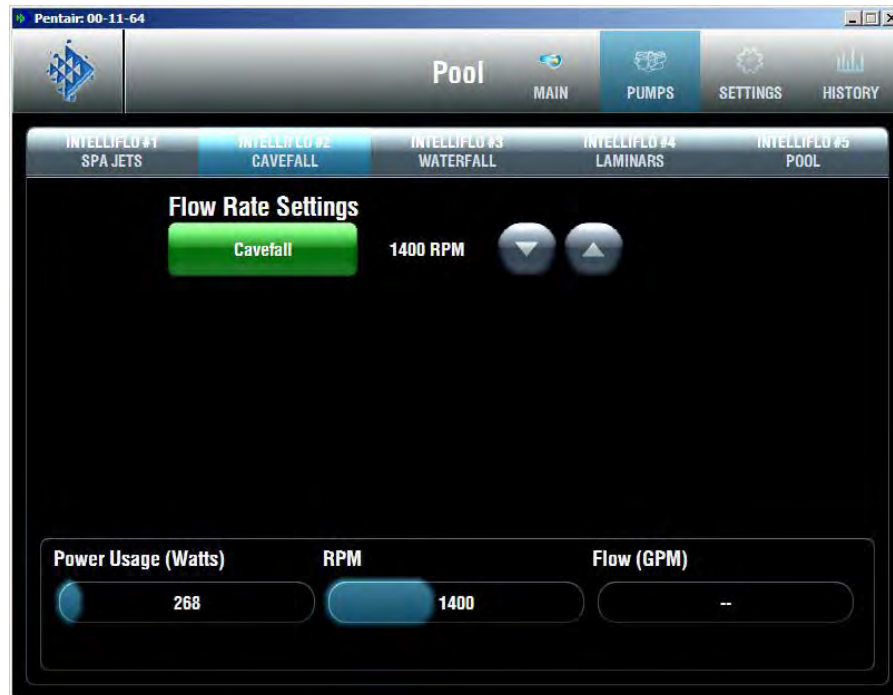

To access the IntelliFlo VS status and controls screen:

- From the main the ScreenLogic2® Interface screen, tap the **PUMPS** and **IntelliFlo #(x)** tab (the name on the first assigned speed, defines the name of the pump tab). When multiple pumps are installed, the number (address) of the pumps is also displayed. The IntelliFlo screen displays the following:
  - Status:** See page 79 for details.
  - Flow Rate Settings/Buttons:** Displays the assigned pump circuits on and off buttons. These circuits are configured in the “Configurator” utility (Step 2 of 5 and 4 of 5), see pages 20 and 31. Tap the button to activate the pump circuit at the specified displayed GPM. The button will then display in green indicating the pump is active. Multiple pump circuit buttons can be active at the same time. For example, if you activate the fountain pump to run at 80 GPM, then tap the waterfall button which is set to 120 GPM, both buttons will display in green at the same time. Without stopping, the pump will ramp up from 80 to 120 GPM until it reaches 120 GPM. If you then tap the waterfall button to deactivate the circuit (button not displayed in green), the pump will ramp the GPM down to the previously set 80 GPM.
  - RPM display and Up/Down button:** Displays the current speed of the pump in revolutions per minute (RPM) for the selected pump circuit as configured in the “Configurator” utility (Step 2 of 5 and 4 of 5), see pages 20 and 31. Tap the **Up** button to increase the RPM. Tap the **Down** button to decrease the RPM. The RPM indicator will display the current status while the pump is operating. If the pump is operating and you use these buttons to increase or decrease the pump’s RPM, the pump will stop, start up again and run at the requested RPM setting.
  - IntelliFlo Output (Pump Off/Pump On):** See page 80 for details.
  - Power Usage (Watts):** Not applicable for IntelliFlo VS.
  - Flow (GPM) status indicator:** See above “Flow Rate Settings/Buttons” for details. The “Flow (GPM)” is not displayed for the IntelliFlo VS.
  - Filter Status:** Not applicable for IntelliFlo VS pumps.



# FAQs and Troubleshooting

## Section 2

### ScreenLogic2® Interface Tips and FAQs

Use the following information to resolve general the ScreenLogic2 Interface operation issues.

#### ScreenLogic2 Interface Technical Support Questions

Before contacting Technical Support, please note that Technical Support personnel can only assist with relevant questions regarding the ScreenLogic2 Interface hardware and software used with the provided the ScreenLogic2 Interface Appel Watch, Andriod interface for phone or tablet, iPhone® or iPad®. Technical support for non-supported devices is not available. Please consult your manufacturer documentation for other questions. For Technical Support contact information, see page viii.

#### Why does the Configuration program say “Looking for Controller”?

If the Configuration program displays “Looking for controller,” for longer then 60 seconds when you start the ScreenLogic2 Interface, this may indicate a communication problem somewhere in the system. If the ScreenLogic2 Interface has been previously working without a problem, try the following steps to resolve the problem:

1. Make sure your wireless the ScreenLogic2 Interface device is connected to your wireless router. In most cases, the easiest way to re-establish a connection is to perform a cold boot of the ScreenLogic2 Interface device
2. Locate your the ScreenLogic2 Interface Protocol Adapter and wireless router. Verify the wireless router Power LED in on. These two devices should be located near one another. Cycle the power to both of these devices. You can use a paper clip to reset the Protocol Adapter by pressing the recessed reset button. You can unplug and plug back in the wireless router to reset it.
3. Verify the wiring to the protocol adapter and the IntelliTouch control system load center.

#### Home Automation interfaces (via the i-Link® Adapter) don't immediately match the information displayed on ScreenLogic's interface after I change a setting.

Home Automation interfaces (via the i-Link adapter) can experience a delay in matching what the ScreenLogic interface displays. This is normal during the ScreenLogic2 Interface to i-Link Interface operations. Your the ScreenLogic2 Interface device will refresh the i-Link screen approximately every 30 - 60 seconds during transmission periods from your the ScreenLogic2 Interface to your i-Link home automation control system.

#### ScreenLogic2 Interface Error Messages

If a system error has occurred with the IntelliTouch control system or related equipment, the alert is displayed on the **Delays & Alerts tab** (see page 60).

1. From the ScreenLogic2 Interface main screen, tap the **Equipment** tab.
2. The error message is displayed in the System Status box. If there are multiple errors, the error messages will be cycled in the status box located in the Equipment screen.

#### How many the ScreenLogic2 Interface Protocol adapters can I install in an IntelliTouch or EasyTouch Control System

You can install one Protocol adapter per the IntelliTouch® or EasyTouch® Control System. However, a total of four the ScreenLogic2 Interfaces can be used simultaneously with the Protocol adapter. For more information about interface accessory kits, refer to “IntelliTouch Control System the ScreenLogic2 Interface Kits,” page 3.

## FAQs and Troubleshooting (Continued)

### I recently changed network hardware and now I cannot connect to ScreenLogic2:

If there has recently been a network change and ScreenLogic2 protocol adaptor is no longer visible there may be a configuration conflict.

Locate your ScreenLogic2 Protocol Adaptor. Use the end of a paperclip or another similar device to press the reset button on the protocol adaptor three times within five seconds with approximately ½ second between presses. This will reset your Protocol Adaptor's network settings back to DHCP addressing which should make it visible on your local area network.

## IntelliFlo® VF Pump Alarms and Warnings

The IntelliFlo Pump displays all alarms and warnings on the control panel display. When an alarm or warning condition exists, the corresponding LED will be lit on the display. All control panel buttons are disabled until the alarm or warning is acknowledged with the **Enter** button. Press the **Reset** button to clear the alarm once the fault condition has been resolved. Note: The IntelliFlo pump will not start if the impeller is rotating. The alerts and warnings are:

- **Power out failure:** The incoming supply voltage is less than 170 VAC. The drive faults to protect itself from over current. The drive contains capacitors that keep it powered up long enough to save the current run parameters. If power is restored during this process, approximately 20 seconds, the drive will not restart until completed.
- **Priming error:** If the pump is not defined as primed within the "Max Priming Time" it will stop and generate a "Priming Alarm" for 10 minutes, then attempt to prime again. The "Max Priming Time" is set by the user on the priming menu. If the IntelliFlo cannot prime within five attempts it will generate a permanent alarm that must be manually reset.
- **Overheat alert:** If the drive temperature gets above 130 degrees, the IntelliFlo will slowly reduce speed until the over temperature condition clears.
- **Anti-freezing:** When active, the motor will run at 1000 rpm for 60 minutes. Only active in Filter and Manual modes. Note: The IntelliFlo's internal anti-freeze protection is disabled when connected to an IntelliTouch control system. Freeze protection is provided by selecting YES at the ON WITH FREEZE portion of the IntelliTouch control system appropriate circuit function menu. To re-enable the IntelliFlo's internal anti-freeze protection, the power to the drive must be cycled off then back on.
- **Blocked system:** Detects a blocked suction line. This alarm resets automatically after 30 seconds and the pump restarts.
- **System service soon:** Alerts the operator that the pump discharge pressure has reached the Clean Filter Pressure as setup in the Filter Menu. The filter status will be displayed as 100%. The green warning LED will be on until a backwash cycle is operated. The IntelliFlo will automatically reduce speed as necessary to not exceed the Clean Filter Pressure.
- **Over current:** Indicated that the drive is overloaded or the motor has an electrical problem. The drive will restart 20 seconds after the over current condition clears.
- **Over voltage:** Indicates excessive supply voltage or an external water source is causing the pump and motor to rotate thereby generating an excessive voltage on the drive's internal DC bus. The drive will restart 20 seconds after the over voltage condition clears.

**For IntelliFlo troubleshooting information, see the IntelliFlo VS Pump Installation and User's Guide (P/N 350075).**

## IntelliFlo® VS Pump Alarm and Warnings

The IntelliFlo VS Pump alarm and warnings are indicated by flashing LEDs on the control panel. For example, if a “Drive Temperature” warning occurs, the LED will blink two times, then Off, then blink two times. This sequence is repeated until the condition is cleared.

- **Warning condition:** If a warning condition occurs the pump will continue to run but at a reduced speed. The Green LED executes a sequence of blinks to indicate which alarm or warning has occurred.
- **Alarm condition:** If an alarm condition occurs the pump will drive stop running. The red LED flashes continuously to indicate the presence of an alarm. The alarm LEDs will reset when the condition clears.

For IntelliFlo troubleshooting information, see the IntelliFlo VS Pump Installation and User’s Guide (P/N 357269).

### Alarm and warnings LED sequence

| Number of time the LED will blink | Alarm                     | Description                     | Action  |
|-----------------------------------|---------------------------|---------------------------------|---|
| 2                                 | Drive Temperature Warning | Excessive drive temperature     | <ol style="list-style-type: none"> <li>1. Ensure the motor fan has adequate area for ventilation.</li> <li>2. Stop motor and allow to cool.</li> <li>3. Run motor at a higher speed to improve cooling air flow.</li> </ol> |
| 5                                 | Unknown alarm             | Electron failure                | <ol style="list-style-type: none"> <li>1. Cycle power to reset pump.</li> <li>2. Replace drive.</li> </ol>  |
| 6                                 | Drive Temperature Alarm   | Excessive drive temperature     | <ol style="list-style-type: none"> <li>1. Ensure the motor fan has adequate area for ventilation.</li> <li>2. Run motor at a higher speed to improve cooling air flow.</li> </ol>   |
| 7                                 | Power Out Alarm           | Supply voltage low              | Ensure proper supply voltage.   |
| 8                                 | Over current Alarm        | Excessive drive current         | <ol style="list-style-type: none"> <li>1. Examine fluid/mechanical system for source of overload.</li> <li>2. De-energize motor and determine if motor spins freely.</li> <li>3. Replace drive.</li> </ol>                  |
| 9                                 | Over voltage Alarm        | Excessive voltage on drive buss | <ol style="list-style-type: none"> <li>1. Rapid switching between speeds can cause excessive voltages on the drive's DC buss.</li> <li>2. Ensure proper supply voltage.</li> </ol>  |

### Suction Blockage:

When something blocks the suction or the pump fully it will shut off immediately (within 1 second). It will also shut off after a few seconds of dead heading with the same alert. The unit will come back on in 30 seconds and ramp up slowly. This function should be tested with all new installations by directing the flow to one suction and covering it with a piece of material other than someone’s hand. This alert is deactivated in Manual mode.

## Connecting remotely to your system

Using the “ScreenLogic Connect” application you can control your pool and spa operations remotely from your laptop computer over the Internet or from your local networked computer in your house. You can download ScreenLogic Connect from [www.pentairpool.com](http://www.pentairpool.com).

To connect remotely to your system:

1. After installing the “ScreenLogic Connect” utility, click the “ScreenLogic Connect” icon on your desktop to start the program.
2. Enter your the ScreenLogic2® Interface system name in the “System Name” box. The name must be entered as follows: **Pentair: xx-xx-xx**  
The **Protocol Adapter Address (xx-xx-xx)** is the last six digits of the Protocol Adapter serial number found on the Protocol Adapter.
3. In the “Password” box, enter the system password that you assigned in the "Set Remote Access Password" dialog in the “General Settings (step 1 of 5)” dialog box. See page 17 for details, or leave the box blank if no password has been assigned.
4. Click the “Remember Login info” check box to save your system name and password so that you don’t have to enter the information each time you want to connect.
5. Click the “Start ScreenLogic” button to connect to your system and start the ScreenLogic2 Interface. Click the “Options” button, then click the “Configure ScreenLogic” button if you want to configure your system using the “Configurator” utility (see page 32 for more information).

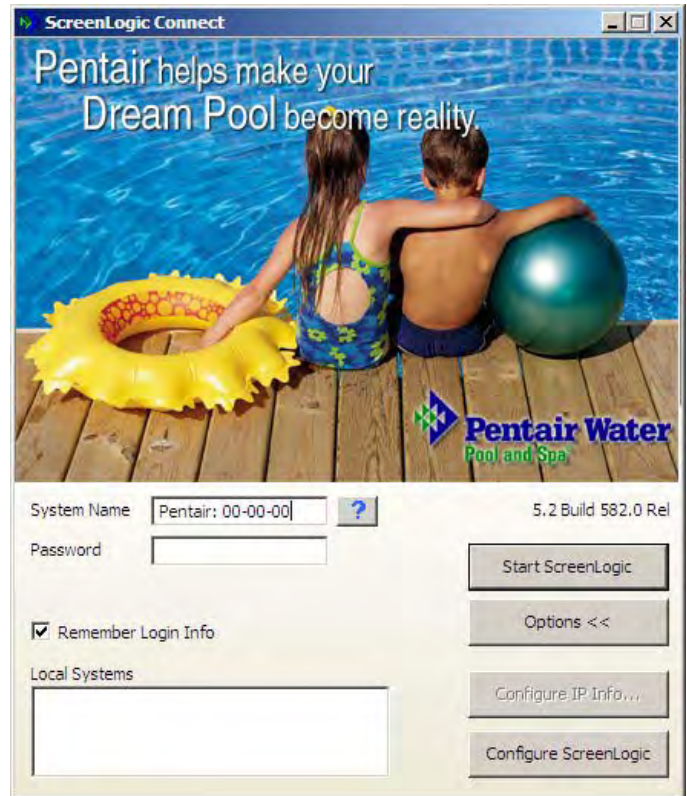

To connect to your system via your local network:

1. Enter your the ScreenLogic2 Interface system name in the “System Name” box. The name must be entered as follows: **Pentair: xx-xx-xx**  
The **Protocol Adapter Address (xx-xx-xx)** is the last six digits of the Protocol Adapter serial number found on the Protocol Adapter.
2. Click the “Options” button. The ScreenLogic2 Interface Connect program will recognize and automatically populate the system name in the “Local Systems” box.
3. Click the “Remember Login info” check box to save your system name and password so that you don’t have to enter the information each time you want to connect.
4. Click the “Start ScreenLogic” button to connect to your system and start the ScreenLogic2 Interface. Click the “Configure ScreenLogic” button if you want to configure your system via the “Configurator” utility (see page 17 for more information).

## Glossary

**+3 IntelliTouch® Control Systems:** Feature Circuits, Macro circuits, and Color Set, Color Swim lighting features are only available with IntelliTouch +3 system models. The IntelliTouch +3 system models are: i7+3 (P/N 520505), i9+3S (P/N 520508), i9+3 (P/N 520509), i10+3 (P/N 520510). For more information, refer to “IntelliTouch Control System Personality Kits,” page 2.

**802.11:** Refers to a family of specifications developed by the IEEE for Wireless LAN technology. 802.11 specifies an over-the-air interface between a wireless client and a base station or between two wireless clients and provides 1 or 2 Mbps transmission in the 2.4 GHz band using either frequency hopping spread spectrum (FHSS) or direct sequence spread spectrum (DSSS).

**802.11b:** An extension to 802.11 that applies to Wireless LANs (WLAN) and provides 11 Mbps transmission (with a fallback to 5.5, 2 and 1 Mbps) in the 2.4 GHz band. 802.11b uses only DSSS. Throughput data rate is 5+ Mbps in the 2.4 GHz band.

**802.11g:** An extension to 802.11 that applies to Wireless LANs (WLAN) and provides 54 Mbps transmission (with a fallback to 1, 2, 5.5, 6, 9, 11, 12, 24, 36, and 48 Mbps) in the 2.4 GHz band. 802.11g uses Orthogonal Frequency Division Multiplexing (OFDM). Throughput data rate is 11+ Mbps in the 2.4 GHz band.

**Access Point:** An Access Point (AP) is stand-alone wireless hub that allows any computer that has a wireless network adapter to communicate with another computer and to connect to the Internet.

**Client computer:** The computer that gets its Internet connection by sharing either the host computer’s connection or the Access Point’s connection.

**Expansion Kit:** A kit that includes additional auxiliaries to an existing Personality Kit. Requires a Load Center for each Expansion Kit.

**Feature Circuits:** Programmable circuits that may control Macro circuits, relays and/or valve actuators.

**Freeze Protection:** A circuit with freeze protection circulates water to protect pipes from freezing, if the outdoor air temperature sensor detects the temperature is getting close to freezing (below 36° F). Refer to “Setup Circuits (Step 2 of 4)”, page 35 for more information.

**Gigahertz (GHz):** A unit of frequency equal to 1,000,000,000 cycles per second.

**High Voltage Compartment:** Large lower right compartment of Load Center for all high voltage wiring including circuit breakers, relays, and GFCI.

**Host computer:** The computer that is directly connected to the Internet using a modem or network adapter.

**Indoor Control Panel:** This 14 button remote controller with LCD (liquid crystal display) is wired to the Personality board in the Power/Load Center. The control panel can be wall mounted inside a house to control the IntelliTouch Control Systems.

**iS4:** Four function Spa-Side remote. Can be spa wall or deck mounted.

**iS10/SpaCommand:** Up to ten function spa-side remote with temperature changing capability. Can be spa wall or deck mounted.

**Internet Protocol (IP) address:** The address of a computer that is attached to a network. Part of the address designates which network the computer is on, and the other part represents the host identification.

**LAN:** A Local Area Network (LAN) is a high-speed, low-error data network covering a relatively small geographic area.



## Glossary (continued)

**Load Center:** Metal enclosure with power relays, transformer, and circuit breakers. The Load Center is installed prior to Personality Kit installation. Used for distributing power for controlling IntelliTouch control systems. Also known as the “sub-panel.”

**Low Voltage Compartment:** Top compartment of Load Center for all low voltage wiring.

**Low Voltage Raceway:** Vertical space in the left side of Power/Load Center for low voltage cabling.

**Megabits-per-second ( Mbps):** Transmission speed of 1,000,000 bits per second.

**Megahertz (MHz):** A unit of frequency equal to 1,000,000 cycles per second.

**MobileTouch Controller:** Wireless controller for the IntelliTouch control systems with all the functionality of the Indoor Control Panel.

**Outdoor Control Panel:** Control panel with flexible hinge installed in upper portion of Power/Load Center to control IntelliTouch® Control Systems.

**Personality Board:** The circuit board mounted on top of the Outdoor Control Panel motherboard. The Personality board defines the system capabilities.

**Personality Kit:** Set of parts to define the capability of a system; may include: Outdoor Control Panel, temperature sensors, actuators, and additional relays.

**Power Center:** Same as Load Center with the exception of the circuit breaker base.

**Relay Circuits:** The circuits that control the relays on the Personality Board. Connectors on top edge of the circuit board.

**RF:** Radio Frequency.

**Screw Terminal Connector:** Removable connector that may attach to circuit board with multiple sockets (anywhere from 2 to 12) to receive wires from controllers and sensors; wires held by screw terminals; multiple wires of a small enough gauge (usually 22 AWG) may be coupled to a single socket of a terminal connector.

**Transceiver:** Circuit board with attached antenna that can send and receive radio frequency (wireless) transmissions.

**Wi-Fi:** Wireless Fidelity is meant to be used generically when referring of any type of 802.11 network, whether 802.11b, 802.11g, 802.11a. A seal of approval from the Wireless Ethernet Compatibility Alliance (WECA).

**WLAN:** Wireless Local Area Network is a type of local-area network that uses high-frequency radio waves rather than wires to communicate between nodes.





1620 HAWKINS AVE., SANFORD, NC 27330 • (919) 566-8000  
10951 WEST LOS ANGELES AVE., MOORPARK, CA 93021 • (805) 553-5000

[WWW.PENTAIR.COM](http://WWW.PENTAIR.COM)

All indicated Pentair trademarks and logos are property of Pentair Inc. or its global affiliates in the U.S.A. and/or other countries. Third party registered and unregistered trademarks and logos are the property of their respective owners

© 2020 Pentair. All rights reserved. This document is subject to change without notice



P/N 520493 - Rev K 2/2020