

OWNER'S MANUAL



PENTAIR



For the Installation, Operation and Service of the

ULTRATEMPTM HX

HIGH PERFORMANCE HEAT PUMP

Should the installer or owner be unfamiliar with the correct installation or operation of this type of equipment, you should contact the distributor/manufacture for the correct advice before proceeding with the installation or operation of this product. The equipment operator or owner must be provided with this owner's manual.

CUSTOMER SERVICE / TECHNICAL SUPPORT

If you have questions about ordering Pentair Aquatic Systems, (“Pentair”) replacement parts, and pool products, please use the following contact information:

Customer Service

Australia Wide (8:30 A.M. to 5:00 P.M. AEST & AWST)

Phone: 1300-137-344

e-mail: au.sales@pentair.com

Web site: visit www.pentairpool.com.au to find information about Pentair products.

Technical Support

Melbourne, Victoria (8:30 A.M. to 5:00 P.M. AEST)

Phone: 1300-137-344

e-mail: au.service@pentair.com



Eco Select®

The Eco Select® brand identifies our most eco-friendly products

As the global leader in pool and spa equipment, we've made a strong commitment to develop and offer the most environmentally responsible products available.

When you see the Eco Select® brand on one of our products, you'll know it is our “greenest” and most efficient product in that equipment category.

These products do the best job of saving energy, conserving water, reducing noise, or otherwise contributing to a more environmentally responsible equipment system. In every case, a product that earns the Eco Select brand is clearly our “greenest” and most efficient choice.

Pentair is a member of the product stewardship program Refrigerant Reclaim Australia

This pool water heat pump contains the synthetic greenhouse gas refrigerant R410A. By law, the refrigerant must be recovered prior to dismantling and scrapping.

Most local government waste facilities, metal merchants and recyclers provide recovery services. Please ensure the refrigerant will be recovered when disposing of this unit.

For more information please visit www.refrigerantreclaim.com.au

Table of Contents

Notices and Warnings	4
UltraTemp Contents and Overview	6
UltraTemp® Heat Pump Kit Contents	6
UltraTemp® Overview.....	6
Quick Start	7
Dimensions & Specifications	8
Dimensions	8
Specifications.....	9
Installation	10
Location and Clearances	11
Anchor Clamp Installation.....	11
Water Connections to the Heat Pump	12
Plumbing Connections.....	13
Multiple Unit Installation	14
Electrical Connections	15
General Information	15
Equipotential Bonding	15
Main Power	15
Configuration	17
Control Panel	17
Control Panel (Continued)	18
Setting the Clock.....	19
Setting the Timer	19
Menu / Setting Parameters	20
Menu / Query Parameters	21
Heating / Cooling Mode	22
Forced Defrost Mode	22
Connecting the Heat Pump to Automation	23
To connect the external control cable plug to the motherboard:	23
Pool/Spa Heating Combinations (Recommended Configurations)	23
Maintenance & Troubleshooting	25
Water Chemistry.....	25
Inspection and Service.....	25
Owner Inspection	25
Professional Maintenance and Service	26
Winterising.....	26
Troubleshooting	28
System Protections / Error Codes.....	28
System Protections / Error Codes (Continued)	30
Replacement Parts	31
Wiring Diagrams	32
Environmental Information	34
Disposal Requirements	34

Notices and Warnings

Important Notice

This manual provides installation and operation instructions for the product. Consult Pentair with any questions regarding this product.

Attention Installer:

This manual contains important information about the installation, operation and safe use of this product. Leave this manual with the owner and/or operator of this product after installation.

Attention User:

This manual contains important information that will help you in operating and maintaining this product. Please retain it for future reference.



WARNING

Before installing this product, read and follow all safety warning notices and instructions which are included. Failure to follow safety warnings and instructions can result in severe injury, death, or property damage. Call 1300-137-344 for additional free copies of these instructions.

Read and Follow all Safety Instructions

This product is designed and manufactured for safe and reliable service when installed, operated and maintained according to the information and installation codes referred to in this manual.

 This is a safety alert symbol. When you see this symbol in this manual or on the product, look for one of the following signal words; DANGER, WARNING, CAUTION and NOTICE and comply with the information. Be alert to the potential hazard. Ensure to read and comply with all of the warnings and cautions in this manual.



DANGER

Risk of Electrical Shock or Electrocutation!

This product must be installed by a licensed electrician. Installations must comply with:

- The Wiring Rules AS/NZS 3000.
- All applicable local codes and ordinances.
- Always disconnect power at the circuit breaker before servicing the load centre. Failure to do so could result in death or serious injury to installer, service person, pool users, or others due to electrical shock.
- Improper installation can create an electrical shock hazard that can result in death or serious injury.



WARNING

Water temperature in excess of 38 degrees Celsius may be hazardous to your health. Prolonged immersion in hot water may induce hyperthermia. Hyperthermia occurs when the internal temperature of the body reaches a level several degrees above normal body temperature of 37°C. The symptoms of hyperthermia include drowsiness, lethargy, dizziness, fainting, and an increase in the internal temperature of the body.

The effects of hyperthermia include: 1) Unawareness of impending danger. 2) Failure to perceive heat. 3) Failure to recognize the need to leave the spa. 4) Physical inability to exit the spa. 5) Foetal damage in pregnant women. 6) Unconsciousness resulting in danger of drowning.



WARNING

To reduce the risk of injury, do not permit children to use this product unless they are closely supervised at all times.



WARNING

The use of alcohol, drugs, or medication can greatly increase the risk of fatal hyperthermia in hot tubs and spas.

Notices and Warnings (Continued)



WARNING

The unit should be located on a solid, level, horizontal surface and securely fixed. Ensure free air-flow to all sides of the unit.



WARNING

Never use an extension cable to connect the unit to the electric power supply. If there is no suitable earthed supply available, have one installed by a qualified electrician.



WARNING

Do not move/repair the unit yourself - Before carrying out any maintenance, service or repair work, the product must be isolated from the mains electrical supply. To prevent possible injury, only qualified engineers should carry out these works.



WARNING

This appliance is not intended for use by persons (including children) with reduced physical, sensory or mental capabilities, or lack of experience and knowledge, unless they have been given supervision or instruction concerning the use of the appliance by a person responsible for their safety. Please ensure that young children are supervised to ensure that they do not play with the appliance.



WARNING

Do not install the unit in a place where there is a chance of flammable gas leaks. If there is a gas leak and gas accumulates in the area surrounding the unit, it could cause an explosion.



WARNING

Water Connections - All plumbing connections should be carried out as per the instructions in this manual. Failure to do so could result in water damage to property.



WARNING

Cleaning the Unit - To prevent injury always shut the power 'OFF' when cleaning or servicing the unit. Avoid contact with the fan when running as this will cause serious injury.



WARNING

Error Codes - If an error code occurs or you can smell burning, isolate the unit immediately and call your local installer.

General Installation Information

1. All wiring work must be performed by a licensed electrician, and must conform to all national, state, and local codes.
2. Installer to provide drainage of compartment for electrical components.
3. Power to all circuits must be supplied via a suitably sized Residual Current Device (RCD) in the fixed wiring.
4. An Earth terminal is located inside the supply terminal box. To reduce the risk of electric shock, this terminal must be connected to the grounding means provided in the electric supply service panel with a continuous copper wire equivalent in size to the circuit conductors supplying this equipment and as per the wiring rules.
5. The electrical supply for this product must include a suitably rated switch or circuit breaker to open all ungrounded supply conductors to comply with the Wiring Rules. The disconnecting means must be readily accessible to the occupant.
6. Supply conductor must be sized to support all loads.

UltraTemp Contents and Overview

UltraTemp® Heat Pump Kit Contents

- Heat Pump Unit.
- Owners Manual.
- Barrel unions x2
- Drain Hose x1.
- Anti-vibration pads x4.

UltraTemp® Overview

The swimming pool heat pump is one of the most economical ways of heating your swimming pool efficiently. Using the free renewable energy from the air, it is over 4/5 time more efficient than traditional heating. The swimming pool heat pump extends your swimming season and gives you comfort at high level. You could enjoy swimming not only in summer, but also in spring, autumn and even winter time.

ECO Friendly

The Heat Pump uses R410A Refrigerant which is ozone friendly dramatically reducing Carbon Emissions.

Titanium heat exchanger

The advanced titanium heat exchanger guarantees a longer life span, free of corrosion. It can be used with all types of water treatment including chlorine, iodine, bromine and salt water.

Multiple functions

- Cooling and heating functions available
- Auto operation, Auto-restart, Auto defrost
- Auto timer on/off: no human attendance is required
- Wide ambient working range: -10°C to 45°C

Reliable operation

The Heat Pump has several built in safety features, which include insufficient water flow protection, high/low pressure protection, overload protection, compressor protection.





Self-diagnosis



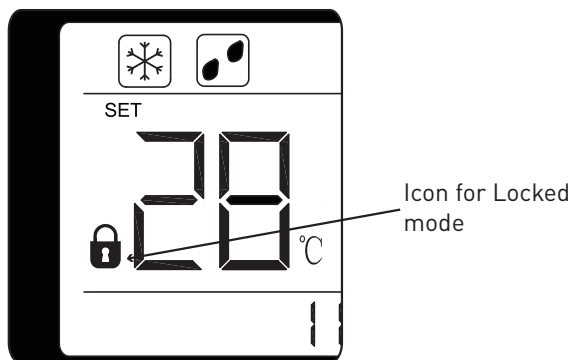



When there is malfunction, the swimming pool heat pump will make self-diagnosis by displaying error code on the control panel. To identify the problem, please refer to ERROR CODES pages in this manual.

Quick Start

- 1. Unlock Keypad** - An icon will show on the screen indicating the keypad is locked. To unlock: Press  for 5 seconds, a 'buzzer' will sound, the keypad will be unlocked.





- 2. Set Clock** - Press and hold  **TIMER (CLOCK)** for 5 seconds to enter into clock setting interface. The clock will begin flashing, press  to modify the hours. The hours of the clock will start flashing, press  and  buttons to alter the value for the hours. Press  again to set the hour. Repeat with the minutes.

- 3. Set Timer** - Press  **TIMER (CLOCK)** to enter into Timer setting interface. Press  and  to select the timer number (T1 or T2). Press  to modify timer. Use  and  buttons to set value for "hour", press  to save. Repeat with minutes. After setting Timer ON, repeat process with Timer OFF.

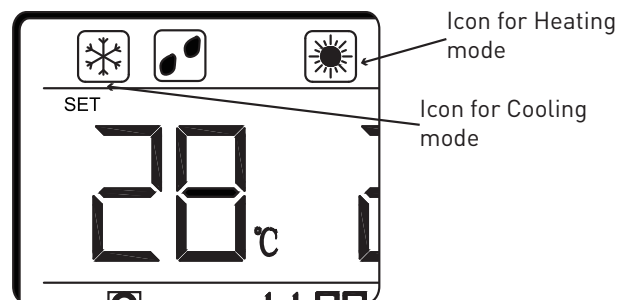
- 4. Turn on** - Press  for 1 second. The fan will start. A 'Sun' icon should show on the screen, indicating the unit is in heating mode (refer to page 22 for details on switching between heating and cooling modes).



- 5. Adjust Temperature** - Press  and  buttons to alter the value for the set temperature.

Dimensions

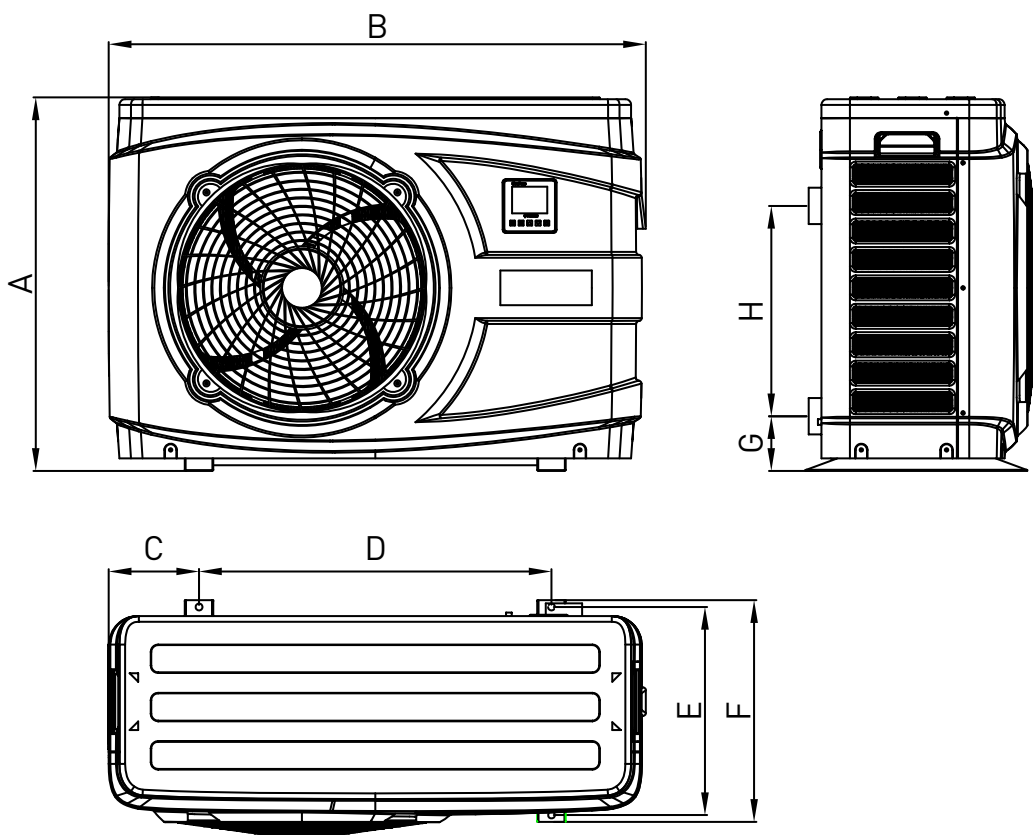

Key	Dimensions	
	UltraTemp HX 9.5kW and 12kW units	UltraTemp HX 15kW, 17kW and 21kW units
A	657mm	757mm
B	945mm	1125mm
C	159mm	181mm
D	620mm	750mm
E	366mm	446mm
F	417mm	490mm
G	96mm	86.5mm
H	370mm	455mm

Specifications

Description		UltraTemp 9.5kW	UltraTemp 12kW	UltraTemp 15kW
Part No.		UTHP-9-HX	UTHP-12-HX	UTHP-15-HX
Ambient 24°C Water 26°C in 28°C out	Capacity (kW)	9.5	12.11	15.3
	Power (kW)	1.53	1.98	2.47
	COP	6.20	6.12	6.20
Ambient 15°C Water 26°C in 28°C out	Capacity (kW)	8.24	9.25	12.1
	Power (kW)	1.62	1.84	2.34
	COP	5.09	5.04	5.16
Ambient 35°C Water 29°C in 27°C out	Capacity (kW)	6.31	8.29	11.2
	Power (kW)	2.00	2.67	3.5
	EER	3.15	3.11	3.2
Power Supply		230-240V ~50Hz	230-240V ~50Hz	230-240V ~50Hz
Max Current		10A	15A	16.7A
Compressor Type		Rotary	Rotary	Scroll
Compressor Brand		Toshiba	Toshiba	Panasonic
Water Flow m³/hr (LPM)		5.19 (87)	6.1 (102)	14 (233)
Refrigerant		R410A 1.3kg	R410A 1.5kg	R410A 1.8kg

Description		UltraTemp 17kW	UltraTemp 21kW
Part No.		UTHP-17-HX	UTHP-21-HX
Ambient 24°C Water 26°C in 28°C out	Capacity (kW)	17.21	21.2
	Power (kW)	2.77	3.42
	COP	6.22	6.2
Ambient 15°C Water 26°C in 28°C out	Capacity (kW)	13.6	16.12
	Power (kW)	2.71	3.19
	COP	5.02	5.05
Ambient 35°C Water 29°C in 27°C out	Capacity (kW)	12.15	13.08
	Power (kW)	3.96	4.35
	EER	3.07	3.01
Power Supply		230-240V ~50Hz	230-240V ~50Hz
Max Current		22.3A	27.4A
Compressor Type		Scroll	Scroll
Compressor Brand		Panasonic	Panasonic
Water Flow m³/hr (LPM)		15.6 (260)	17.2 (287)
Refrigerant		R410A 2.0kg	R410A 2.1kg

Installation

Only a qualified service person should install the UltraTemp™ Heat Pump. Before installing this product, refer to the Important Warning and Safety Instructions on page 4.

Materials Needed for Installation

The following items are needed and are to be supplied by the installer for all heat pump installations:

1. Plumbing connections (40mm).
2. Level surface for proper drainage.
3. Suitable electrical supply line. See rating plate on unit for electrical specifications. A junction box is not needed at the heat pump; connections are made inside of the heat pump electrical compartment. Conduit may be attached directly to the heat pump jacket.
4. Electric isolation switch that will interrupt all power to the unit. This switch must be within line of sight of the heat pump. Check local codes and wiring rules AS/NZS 3000 for requirements.
5. Watertight conduit to run the electrical supply line.

Equipment Pad

For proper drainage of condensation and rain water, place the heat pump on a flat slightly pitched surface, such as a concrete or fabricated slab (pad). If possible, place the pad at the same level or slightly higher than the filter system equipment pad.

Note: Be sure that the pad is pitched not more than 20mm per metre in any direction as needed for runoff.

Drainage and Condensation

Condensation occurs from the evaporator coil while the unit is running, and drains at a steady rate (up to 20L per hour), depending upon ambient air temperature and humidity. The more humid the ambient conditions, the more condensation will be produced. The bottom of the unit acts as a tray to catch rainwater and condensation. Keep the drain holes, located on the bottom pan of the base of the unit, clear of debris.

Roof Run-off

Make sure the heat pump is not located where large amounts of water may run-off from a roof into the unit. Sharp sloping roofs without gutters will allow massive amounts of rain water, mixed with debris from the roof to be forced through the unit. A gutter or down spout may be needed to protect the heat pump.

Lawn Sprinklers

Avoid placing lawn sprinkler near the heater - they can spray water into the heater and void the warranty. Be sure to direct any spraying water away from the heater. Note the wind direction to be sure water from sprinklers is not blown toward the heater. Sprinkler heads can produce high water pressure and spray at an angle, different from typical rain and humid weather. Also, sprinklers connected to a well water system can cause mineral build up on the evaporator coils and electronics. Salt water can also be an issue if located near the coast.

Location and Clearances

All criteria given in the following sections reflect minimum clearances. However, each installation must also be evaluated, taking into account the prevailing local conditions such as proximity and height of walls, and proximity to public access areas. The UltraTemp® Heat Pump must be placed to provide clearances on all sides for maintenance and inspection.

1. At least 1.5m access must be available in the front and 250 mm on all the other sides of the heat pump for service and proper air flow. (Manufacturer's recommendation).
2. If the heat pump is to be installed under a cover or under a vertical overhang, the unit must have a minimum of 1.5m clearance from the top of the heat pump. (Manufacturer's recommendation).
3. Install a minimum of 1.5m from the inside wall of the pool or spa unless the heat pump is separated from the pool or spa by a 1.5m high solid fence or other permanent barrier.
4. Install heat pump a minimum of 250mm from the wall of the house.
5. Allow 600mm clearance above the heat pump for service access.

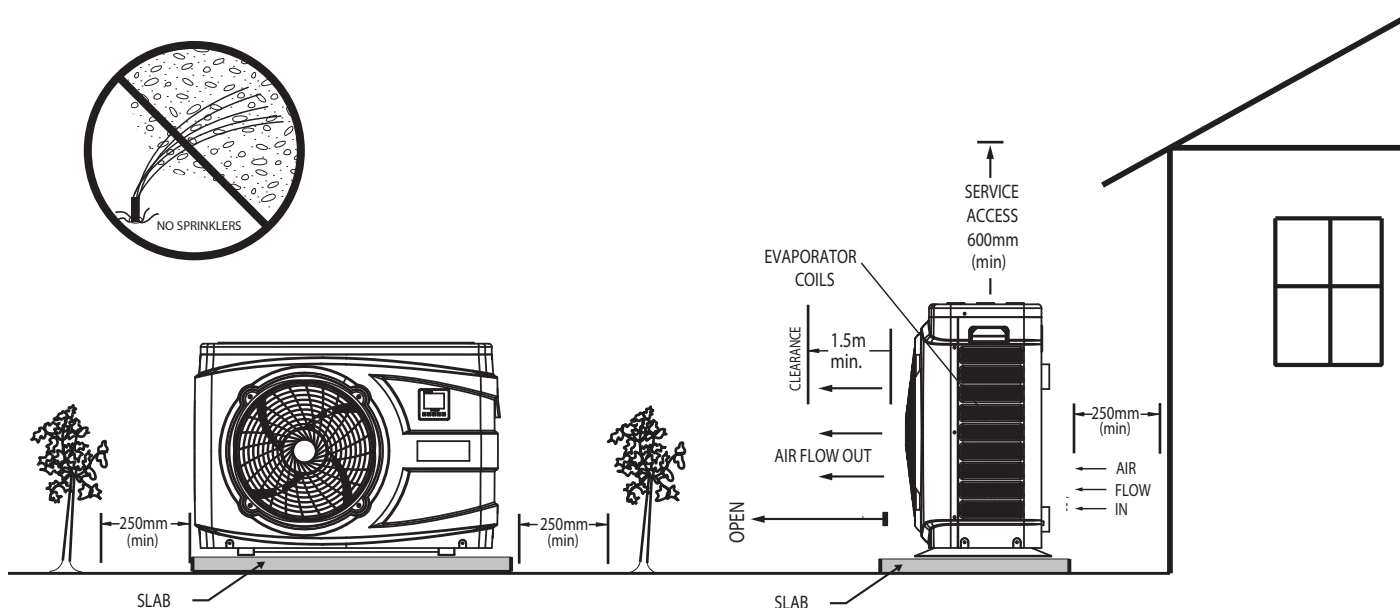

Figure 1: Location and Clearances

Anchor Clamp Installation

Installation of the anchor clamps is recommended in all installations. Anchor clamps hold the heat pump to the equipment pad in order to withstand high winds, accidental movement and excessive vibration.

To install the anchor clamps:

1. Be sure the heat pump is in its permanent location on the equipment pad.
2. Locate the clamps at the base of the heat pump in the four (4) locations, shown in the image to the right.

Note: Bolts and bolt anchors are not included with the heat pump. The installer must provide 1/4" x 1-3/8" stainless steel anchor bolts and the appropriate size concrete anchor to mount the clamp to the equipment pad. Be sure to check local codes.

3. Fit the anti-vibration pad (included) under each anchor clamp.

Anchor Clamp Installation (Continued)

4. Mark the position of the hole in each clamp on the equipment pad.
5. Use a masonry drill bit and drill a hole in the cement with a diameter as determined by the concrete anchor, at each of the marks on the equipment pad. The hole should be approximately 1½ in. deep.
6. Insert a bolt anchor into each of the holes. Be sure the anchors are set completely into the holes.
7. Position the anchor clamps so that the holes in the clamps are over the bolt anchors. Be sure that the clamp hooks are over the lip of the heat pump base.
8. Insert an anchor bolt through each clamp into the anchor and tighten to secure the clamp and heat pump to the equipment pad.

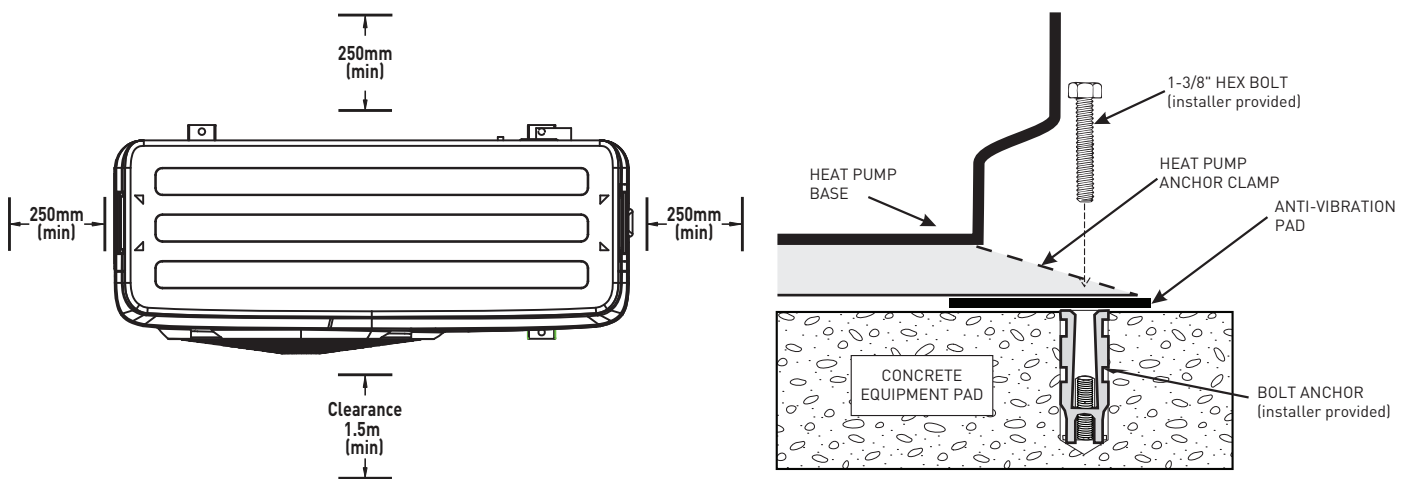

Figure 2&3: Anchor Clamp Installation

Water Connections to the Heat Pump

1-1/2" / 40mm quick connect union fittings have been supplied for the water inlet and outlet connections. Filtered cool water is plumbed to the inlet, as labelled. Heated water flows through the outlet, as labelled. PVC piping (AS/NZS 1477) should be connected to the heat pump. The unions, provided with the unit, accept 40mm PVC pipe.

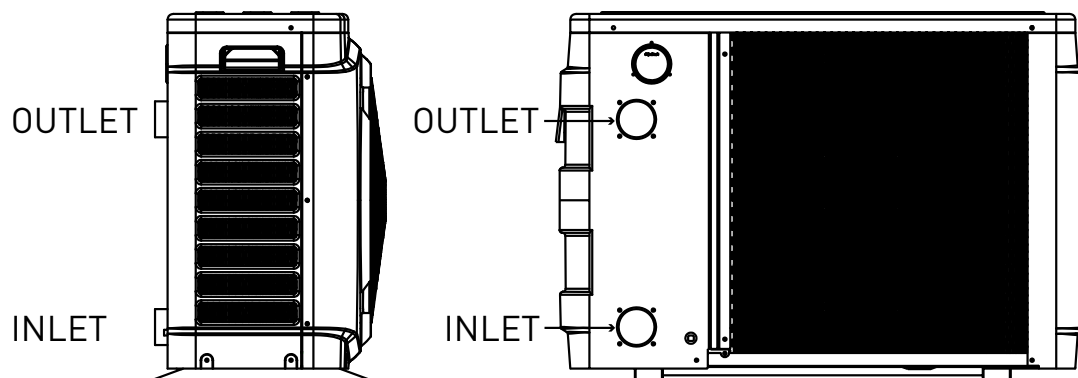

Figure 4: Water Connections to the Heat Pump

Plumbing Connections

The image below shows the standard plumbing layout with a single UltraTemp™ Heat Pump unit. Arrangement of pool system components (other than the standard plumbing image below), can affect the operation of the heat pump.

Note: Be advised that when pool equipment is located below the pool surface a leak can result in large-scale water loss or flooding. Pentair is not responsible for such water loss or flooding or damage.

The heat pump should be connected to a filtration circuit through a by-pass which consists of 3 valves. It is imperative that the by-pass is placed after the pump and the filter. These valves allow to regulate the water flow which passes through the heat pump and to isolate the heat pump completely for any maintenance work, without cutting the filtration flow.

If your installation is equipped with water treatment devices (chlorine, bromine feeder, salt water chlorine generator, others) the by-pass must be installed before the water treatment devices, with a non-return check valve between the by-pass and water treatment devices.

Water inlet and outlet are designed to be connected to rigid pressure PVC tube (for swimming pool) 40mm, directly glued to the union connectors provided.

Water pipes must be fixed on the floor or the walls, so the heat pump will not support the weight of the water inside the plumbing.

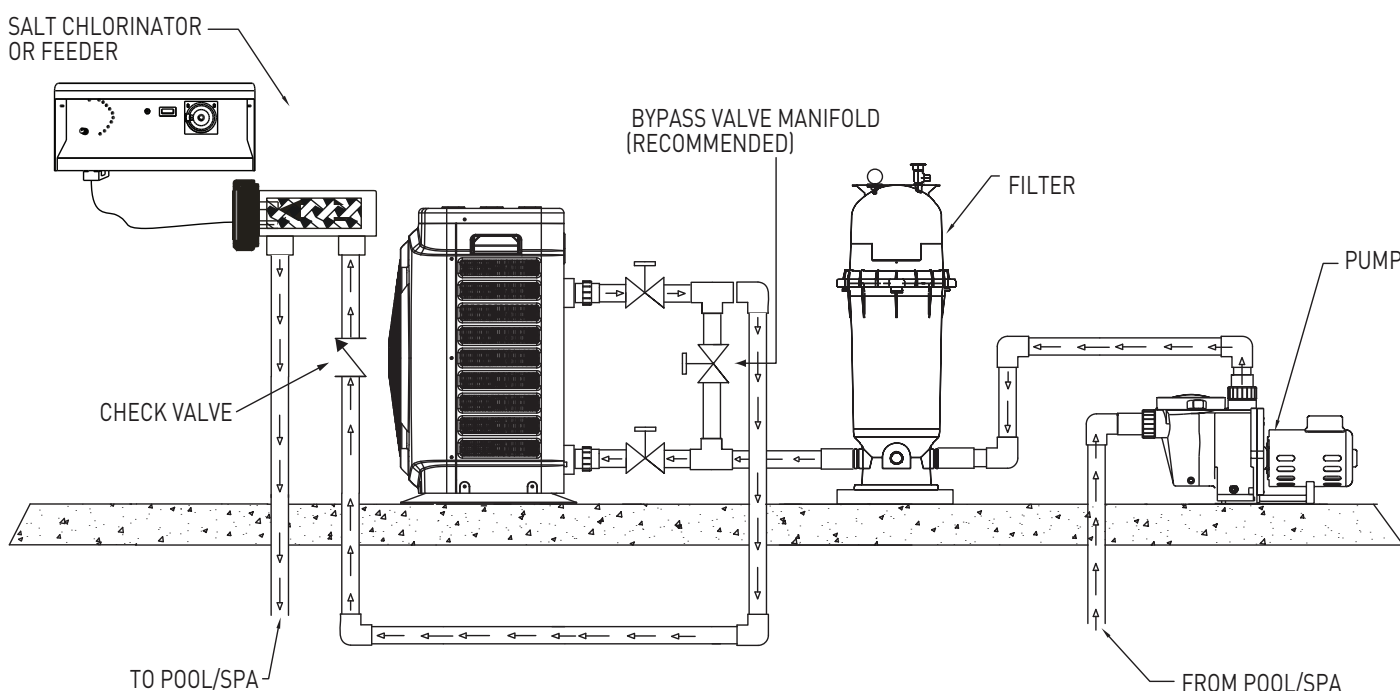

Figure 5: Plumbing Connections

Multiple Unit Installation

Heat Pump, Heater and/or Solar Combination In certain regions of the country it may be more economical to run a heat pump during the warmer months and a gas heater during the cooler months. In some situations it may be desirable to run the heat pump in the “Chiller” mode, if so equipped, during the hottest portion of the year and a heater during the cooler months. The Pentair heat pump may be used in conjunction with a gas or electric heater or any combination of heat sources including solar. All heat sources must be plumbed in series to work correctly and efficiently. A recommended plumbing layout for a heat pump / heater / solar combination heating system for a pool / spa combination is shown below. Your system may not contain all of these components, but the basic plumbing will apply by eliminating the component in the illustration that is not a part of your system.

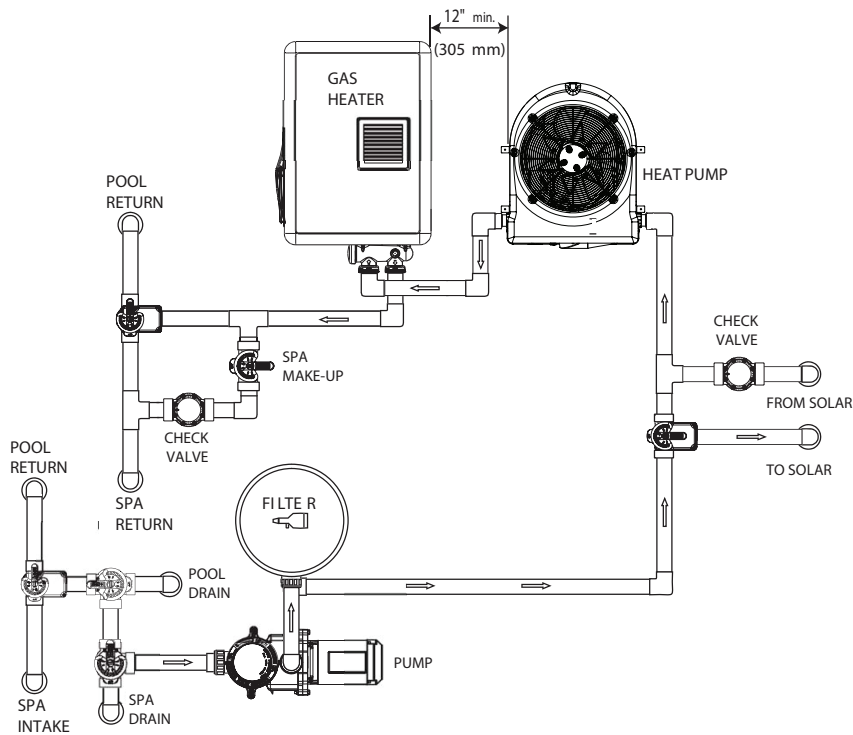

Figure 6: Multiple Heat Source Configuration

Electrical Connections

General Information

Wiring connections must be made exactly as shown in the wiring diagram found on the inside of the heat pump access panel; see the wiring diagrams on pages 31-33.

The UltraTemp™ Heat Pump must include a definite means of grounding and bonding. There is a ground lug inside the heat pump electrical compartment.

Equipotential Bonding

The Wiring Rules (AS/NZS 3000) and most other codes require in many circumstances that metallic components of a pool structure, including reinforcing steel, metal fittings, and above ground equipment be bonded together with a solid copper conductor. The heat pump contains a metal (titanium) heat exchanger which is in contact with the pool water, which may need to be connected to this bonding grid. A bonding lug is provided to ensure this requirement can be met. Please refer to the Wiring Rules (AS/NZS 3000) and any local codes for details on whether equipotential bonding is required.

Main Power

Electrical wiring to the heat pump must be in accordance with the latest edition of the Wiring Rules (AS/NZS 3000). All wiring must be done by a certified or qualified electrician.

The following is the procedure to wire the heat pump to the electrical source:

Be sure the power to the circuit for the heat pump is turned off.

1. Remove the front panel of the heat pump cabinet (you need to loosen the front screws on the top panel as well).
2. Remove the service panel to the heat pump electrical compartment.
3. Electrical supply lines must be run through watertight conduit on the front panel. Run the wires and conduit from the power source and connect them to the conduit connection. Use suitable gauge connection wire as per below table.
4. Connect the power leads to the terminals in the electrical compartment as shown in the wiring diagram.
5. Verify that all other wires are secure, they may have loosened during shipment.
6. Connect the ground wire to the ground lug provided.
7. Replace the service panel and reinstall screws to hold it in place.
8. Replace the front panel.

Heat Pump	Cable Size
9.5kW	10A Plug and Cable Provided
12kW	15A Plug and Cable Provided
15kW	3 x 2.5mm ² (A, N, E)
17kW	3 x 4mm ² (A, N, E)
21kW	3 x 6mm ² (A, N, E)

Electrical Connections (Continued)



Figure 7: Location of Electrical Panel

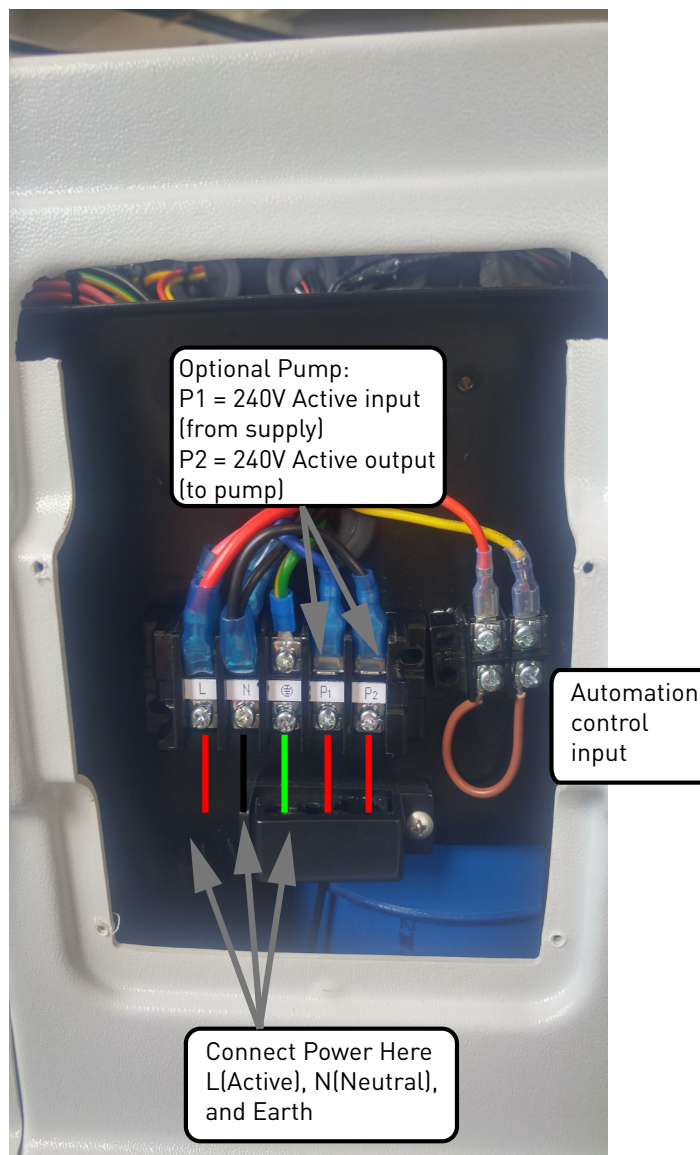

Figure 8: Electrical Connections for Single Phase Units

Configuration

Control Panel

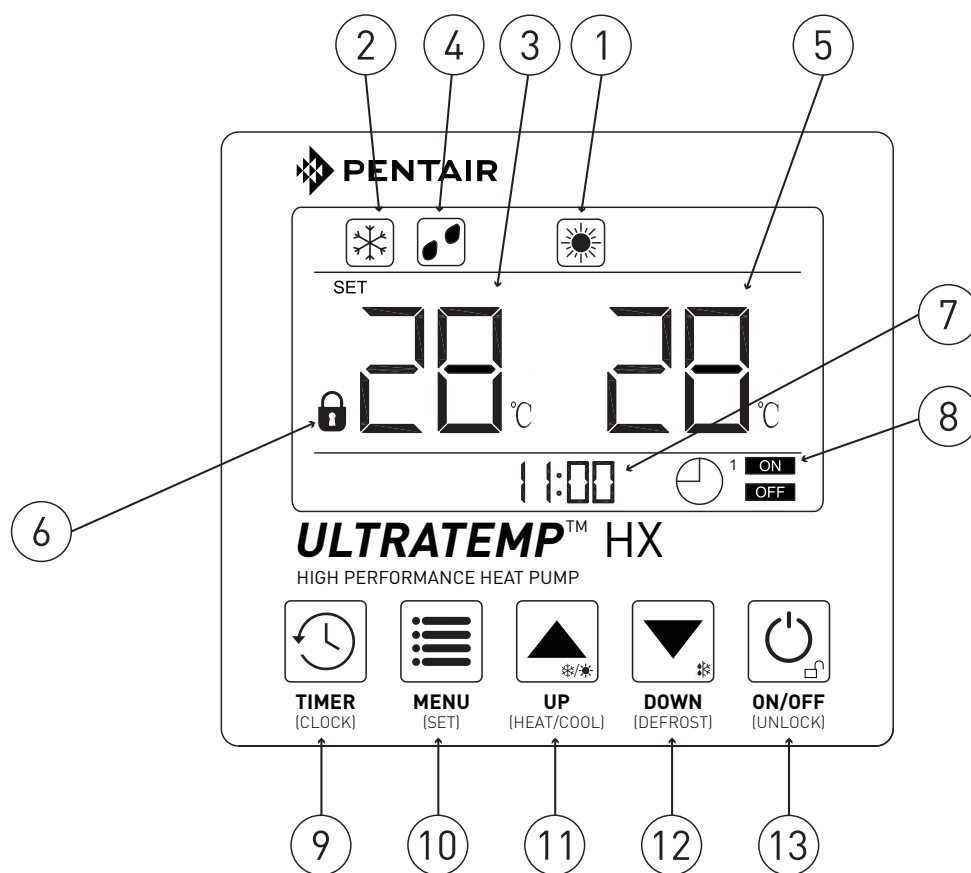















Figure 9: Control Panel

Ref	Icon	Function
1	Heat Mode	This icon will show if the UltraTemp is on and is in Heating mode. The UltraTemp will heat the water until the set temperature is reached.
2	Cool Mode	This icon will show if the UltraTemp is on and is in Cooling mode. The UltraTemp will cool the water until the set temperature is reached.
3	Set Temperature	This shows the set temperature. Press the UP/DOWN buttons to alter the set temperature. The UltraTemp will heat/cool the water until the Set Temperature is reached.
4	Defrost	This icon will show when defrost mode is activated.
5	Water Temperature	This shows the inlet water temperature to the UltraTemp. It represents the actual water temperature of the pool or spa.

Control Panel (Continued)













6	Keypad Lock		This icon will show if the keypad is locked. The keypad will automatically lock after a period of inactivity. To unlock, hold the power button for 5 seconds.
7	Clock		This shows the current time. To adjust the time, hold the TIMER button for 5 seconds.
8	On/Off Timer		This shows the current active timers. There are 2 timers that can be set. Numbers 1-2 will show on the screen representing each time clock.
Ref	Button		Function
9	TIMER (CLOCK)	 TIMER (CLOCK)	Press once to access on/off timer menu. Hold for 5 seconds to access clock setting menu. <i>Refer to Page 19 for further details.</i>
10	MENU (SET)	 MENU (SET)	Press once to query current running parameters and error code display. Hold for 5 seconds to access parameter settings menu. <i>Refer to Page 20 for further details.</i>
11	UP (HEAT/COOL)	 UP (HEAT/COOL)	Press once to increase set temperature by 1 degree Celsius. Hold for 5 seconds to switch between Heating and Cooling modes. <i>Refer to Page 22 for further details.</i>
12	DOWN (DEFROST)	 DOWN (DEFROST)	Press once to decrease set temperature by 1 degree Celsius. Hold for 5 seconds to force into Defrost mode. <i>Refer to Page 22 for further details.</i>
13	ON/OFF (UNLOCK)	 ON/OFF (UNLOCK)	Press once (Hold for 1 second) to turn UltraTemp on or off. Hold for 5 seconds to unlock the keypad. <i>Refer to Page 22 for further details.</i>

Setting the Clock









1. On the main interface screen, press and hold  for 5 seconds to enter into clock setting interface.
2. The clock will begin flashing, press  to modify the hours. The hours of the clock will start flashing, press  and  buttons to alter the value for the hours. Press  again to set the hour.
3. After setting the hours, the minutes will be flashing. Press  and  buttons to alter the value for the minutes.
4. After setting the minutes, press  or  to confirm clock settings and go back to main interface.

Note: You can press  at any time to confirm clock settings and go back to main interface.

Setting the Timer





1. On main operation interface screen, press  **TIMER (CLOCK)** to enter into Timer setting interface.
2. Then press  and  to select the timer number. There are 2 separate on/off Timers.
3. When Timer 1 is flashing, press  to enter into Timer 1 ON "hour" digit setting. Use  and  buttons to set value for "hour". After setting Timer 1 ON "hour" value, press  again to enter into Timer 1 ON "minutes", which will flash, again use  and  buttons to set value for Time 1 ON "minute" digit.
4. After setting Timer 1 ON "minute" digit, press  again to enter into Timer 1 OFF "hour" digits, which is set the same as above.
5. When finished setting Timer OFF time, press  again to confirm current Timer settings and enter into Timer 2 ON/OFF settings. This operation is the same as for Timer 1 settings.
6. Press  at any time to confirm timer settings and go back to main interface.
7. On Timer setting interface screen, press  for 5 seconds to cancel current Timer ON/OFF settings.

Menu / Setting Parameters

1. On main interface screen, press  for 5 seconds to enter into parameter setting menu.
Press  and  buttons to navigate to each parameter. Refer to table below for a list of all parameters.
2. On parameter setting interface, press  to enter into parameter setting menu. Press  and  buttons to modify parameter value. Press  again to save value and go back to parameter setting menu.
3. Press  at any time to confirm settings and go back to main interface.

Code	Parameter Name	Description	Range	Default
L2	Temperature Differential	Set how much the water temperature needs to drop below the set temperature, for the heat pump to start up again. E.g. If the set temperature is 28°C and the water temperature is 28°C, the heat pump will stop heating and not restart until the water temperature drops to 26°C (if the Temperature Differential is set to 2°C).	1-25°C	2°C
L3	Heat Mode Temp	This is the set temperature when in Heat mode.	5-40°C	28°C
L4	Cool Mode Temp	This is the set temperature when in Cool mode.	5-32°C	12°C
L5	Compressor Current			



Menu / Query Parameters

- On main interface screen, press  to enter into parameter query menu. Press  and  buttons to navigate to each parameter. Refer to table below for a list of all parameters.
- Press  at any time to confirm settings and go back to main interface.

Code	Parameter Name	Description	Typical Range
A1	Coil temp	This is the evaporator coil temperature.	(-10)-15°C (Heat) 35-48°C (Cool)
A2	Compressor suction gas temp	This is the refrigerant gas temperature at the inlet of the compressor.	(-10)-15°C (Heat) 10-25°C (Cool)
A3	Compressor exhaust gas temp	This is the refrigerant gas temperature at the outlet of the compressor.	40-80°C (Heat) 60-95°C (Cool)
A4	Ambient air temp	This is the ambient (atmospheric) temperature.	(-10)-45°C
A5	Outlet water temp	This is the water temperature at the outlet of the heat pump (return to pool).	5-40°C
A6	Compressor current	Displays the compressor current (3-Phase units only).	5-10A
A7	Opening of the EEV	Opening angle of the EEV (Electronic Expansion Valve).	10-60
E1-E6	Error code display	Displays up to 6 error codes, in the unlikely event or malfunction. Refer to Troubleshooting section for error code details.	None

Heating / Cooling Mode

The UltraTemp heat pump can cool as well as heat the water. To switch from heating mode to cooling mode (and vice-versa):

1. On main interface screen, hold  for five seconds.
2. The 'sun' icon will change to a 'snow-flake' icon, indicating that the UltraTemp is in cooling mode.
3. To change back to heating mode, hold  for five seconds. The 'snow-flake' icon will change back to a 'sun' icon, indicating that the UltraTemp is in heating mode.

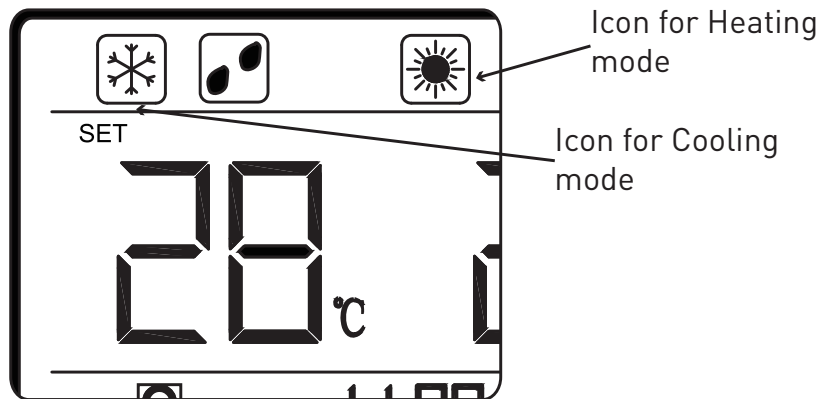





Figure 10: Heating/Cooling Mode Icons

Forced Defrost Mode

1. When the unit is on, hold  for 5 seconds to enter into forced defrosting mode. 8 minutes later the forced defrosting will finish.
2. Press  for 1 second until unit turns off, to cancel defrost.

Keypad Lock / Unlock

The keypad will automatically lock after 60 seconds of inactivity. An icon will show on the screen indicating the keypad is locked. To unlock:

1. Press  for 5 seconds, a 'buzzer' will sound, the keypad will be unlocked.
2. Repeat process to lock.

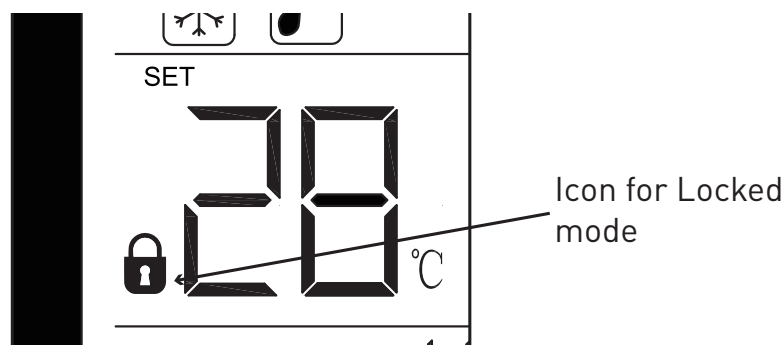

Figure 11: Locked Screen Icon

Connecting the Heat Pump to Automation

To connect the external control cable plug to the motherboard:

1. Run a two-conductor cable from the heat pump external control to the low voltage raceway to the motherboard in the Pentair Automation control centre.
2. Strip the conductors 7mm. Insert the wires into the GAS HEATER two-screw terminals (J19) on the motherboard. For wiring details, refer to "EasyTouch System Wiring Diagram," on page 20.
3. At the heat pump, connect the wires to.
4. Do NOT disconnect or wire around the thermostat, pressure switch, high limit switch, or other safety devices.
5. Select the pool or spa thermostat and toggle the heater to that setting.
6. Turn the thermostat for the selected setting to maximum.

Pool/Spa Heating Combinations (Recommended Configurations)

Heat Sources	Connections	EasyTouch Configuration
Heat Pump Only	Connect heat pump to 2-wire terminal marked "Gas Heater" (J19).	Menu>Heat Menu>Pool Temp/ SRC>Heater Menu>Heat Menu>Spa Temp/ SRC>Heater
Heat Pump + Gas Heater	Connect gas heater to 2-wire terminal marked "Gas Heater" (J19). Connect heat pump to relay connected to "Solar" terminal.	Menu>Settings>Solar>Enable = Yes Menu>Settings>Solar>Solar is Heat Pump = Yes Menu>Heat Menu>Pool Temp/ SRC>Heat Pump Menu>Heat Menu>Spa Temp/ SRC>Heater
Heat Pump + Solar	Connect heat pump to 2-wire terminal marked "Gas Heater" (J19). Connect solar valve actuator to VLVA (single pump system) or connect solar booster pump electrical outlet relay to "Solar" terminal (separate solar pump system).	Menu>Settings>Solar>Enable = Yes Menu>Heat Menu>Pool Temp/ SRC>Solar (or solar preferred). Menu>Heat Menu>Spa Temp/ SRC>Heater Menu>Settings>Solar>Solar is Heat Pump = NO

Connecting the Heat Pump to Automation (Continued)

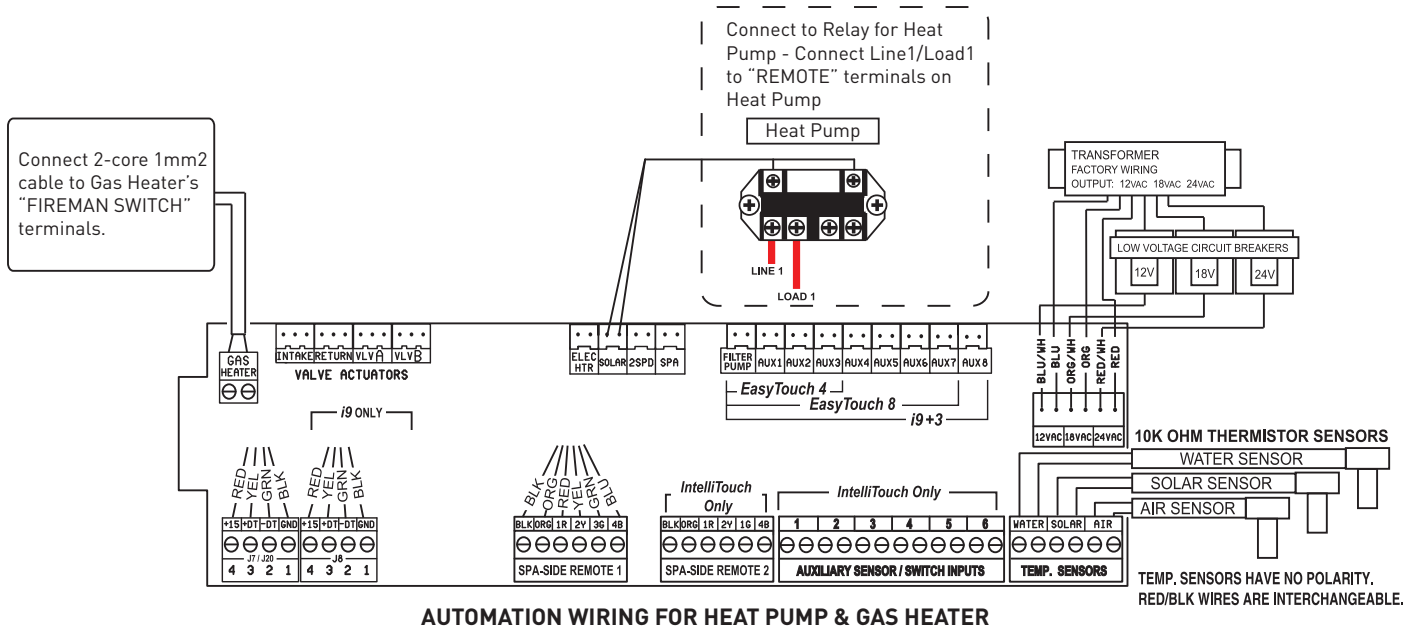
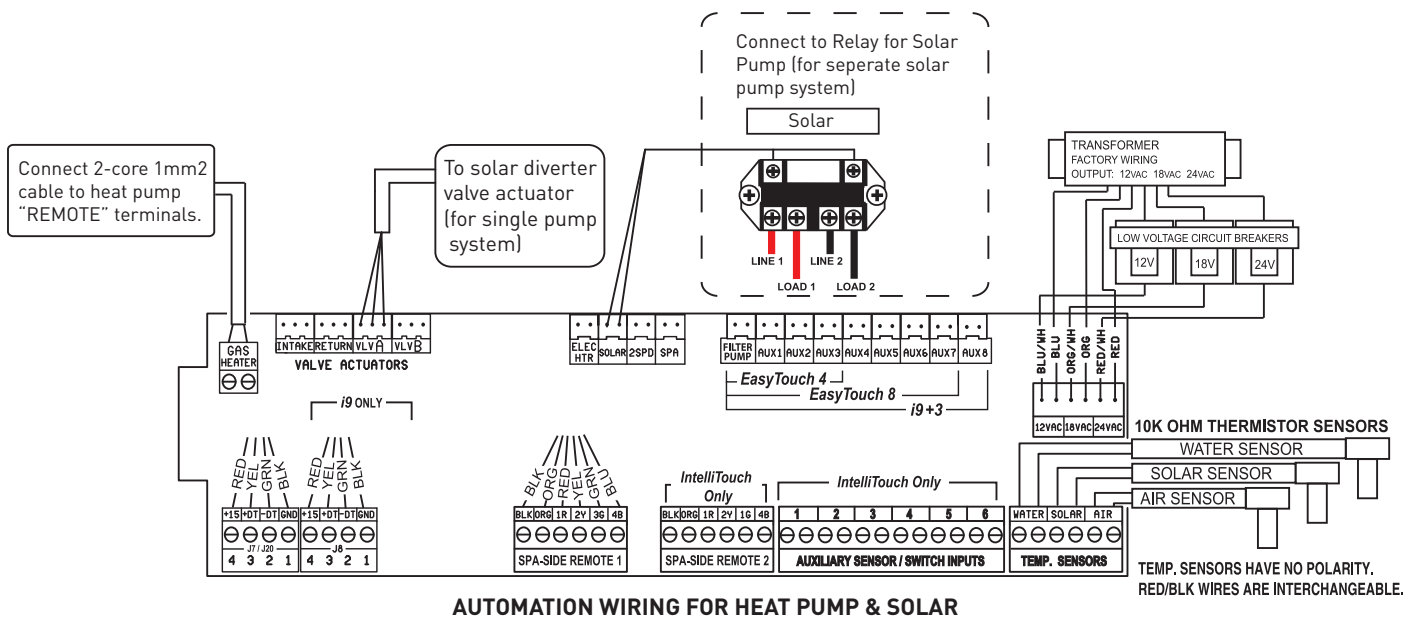
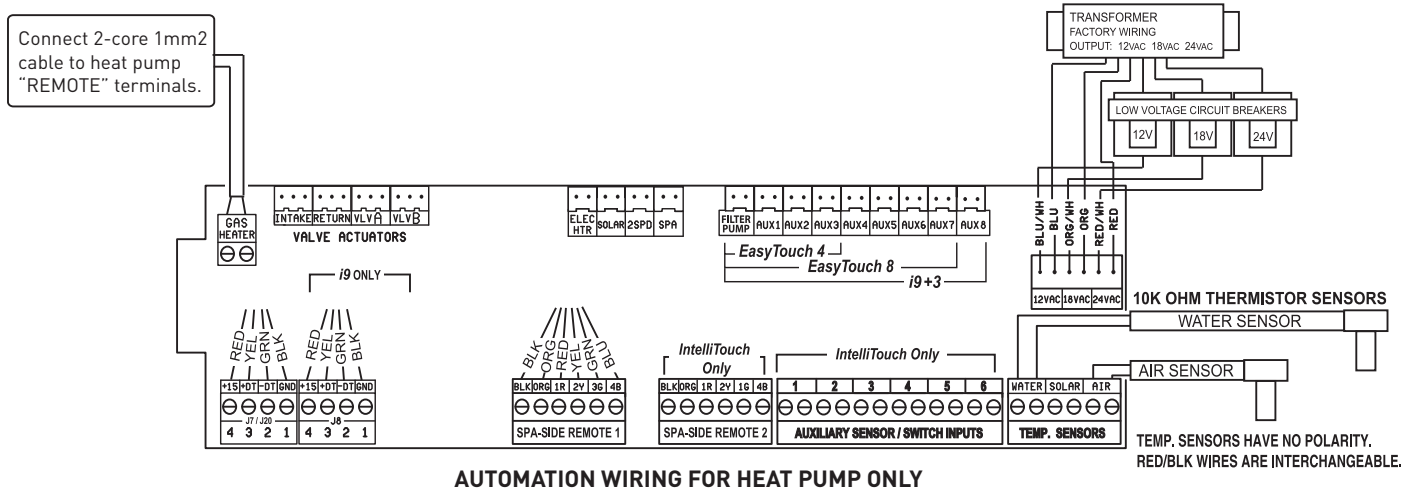

Figure 12: Automation Connections

Maintenance & Troubleshooting

Water Chemistry

Proper chemical balances are necessary for sanitary bathing conditions as well as ensuring your heat pump's long life. Be sure to keep your chemical and mineral concentration levels within the values indicated in the table below. Failure to maintain proper water chemistry may cause damage to the UltraTemp® Heat Pump and may void the warranty.

Test	Recommended Level
Free Chlorine	1.0 to 3.0 ppm (3.0 to 5.0 spa)
Bromine	2.0 to 4.0 ppm (3.0 to 5.0 spa)
pH	7.4 to 7.6
Total Alkalinity (TA) <i>with Calcium, Lithium, and Sodium Hydrochlorite</i>	80 to 100 ppm
Total Alkalinity (TA) <i>with Sodium Dichlor, Trichlor, Chlorine Gas, and Bromine Compounds</i>	100-120 ppm
Calcium Hardness (CH)	200 to 400 ppm
Cyanuric Acid (Stabiliser)	30 to 50 ppm <i>(less than 30ppm with ORP controllers)</i>
Total Dissolved Solids (TDS)	Less than 2000 ppm
Copper	0 ppm

* Concentration levels taken from "Basic Pool and Spa Technology" published by NSPI (National Spa and Pool Institute).

Inspection and Service

Pentair Heat Pumps are designed and constructed to provide long performance life when installed and operated properly under normal conditions. Periodic inspections are important to keep your heat pump running safely and efficiently through the years. Failure to properly maintain your unit can void the warranty.

Owner Inspection

Pentair recommends that you inspect your heat pump on a continual basis and especially after abnormal weather conditions. The following basic guidelines are suggested for your inspection:

1. Make sure the front of the unit is accessible for future service.
2. Keep the top and surrounding areas of the heat pump clear of all debris.
3. Keep all plants and shrubs trimmed and away from the heat pump.
4. Keep lawn sprinkler heads from spraying on the heat pump to prevent corrosion and damage.
5. If the unit is installed under a roof edge, install a gutter or diverter to prevent excessive water and debris from pouring down into the unit.
6. Do not use this heat pump if any part has been under water. Immediately call a qualified professional technician to inspect the heat pump and replace any part of the control system which has been submerged.

Maintenance & Troubleshooting Continued

The UltraTemp® Heat Pump will produce condensation (water) while in operation. The heat pump base is designed to allow the condensation to exit through the bottom drain port when the unit is running. The condensation will increase as the outdoor air humidity level increases. Check the following at regular intervals to ensure proper condensate drainage:

1. Visually inspect and clear the bottom drain ports of any debris that could clog the ports.
2. Keep the top air flow discharge and air flow intake area clear of debris so the air flow through the heat pump is not restricted. The cooler discharge air from the top should not accumulate and be drawn into the side air intake coils.
3. Be sure the condensate run-off is properly directed away from the equipment pad to keep it from undermining the pad.
4. Be sure the condensate water does not puddle inside the heat pump. To be sure it is condensate water, check for the absence of chlorine.

During normal operation, the heat pump produces three to five gallons of condensate per hour. If condensate drainage is above this range during operation or if water continues to drain from the base when the heat pump is not in operation for more than an hour, a leak in the internal plumbing may have occurred. Call a qualified heat pump technician to investigate the problem.

Professional Maintenance and Service

The maximum heat output and efficiency of a heat pump is dependent upon the quality and performance of the major components used. Equally important are the environmental conditions (for example, air temperature, humidity, water temperature, and wind).

To maintain maximum performance and efficiency, keep the air coil clean from dirt and debris. It is recommended to clean your air coil once a year by flushing the coil with compressed air or hosing off the coil with a garden hose.

Care should be taken to not bend the coil fins as this will restrict the airflow and lower your heat pump performance. Compressed air can also damage the heat pump coil.

DO NOT USE A PRESSURE CLEANER ON THE UNIT.

The heat pump should be maintained at least once a year by qualified personnel to maintain maximum performance and efficiency. The unit should be powered off during maintenance.

Winterising

In areas where freezing temperatures occur, you should protect your pump, filter, and heat pump from the elements. Perform the following steps to completely drain the heat pump.

1. Turn off the electrical power to the heat pump at the main breaker panel.
2. Shut off the water supply to the heat pump.
3. Disconnect the water inlet and outlet unions located on the lower front panel of the heat pump.
4. Blow out the water lines.
5. Cover only the top of the heat pump to prevent debris from falling into the unit. Do not wrap the sides of the heat pump with any plastic or other material that will retain heat or moisture inside the unit.

Spring Start Up

If your heat pump has been winterised, perform the following steps when starting the system in the Spring:

1. Uncover the heat pump and inspect the top and sides for any debris or structural problems.
2. Connect the water inlet and outlet unions on the sides of the heat pump.

Maintenance & Troubleshooting Continued

3. Turn on the filter pump to supply water to the heat pump. Open the filter air bleeder and circulate water through the system long enough to bleed all the air out of the pool system. Check for leaks in and around the heat pump.
4. Turn on the electrical power to the heat pump at the main breaker panel.

To protect the paintwork, avoid leaning or putting objects on the shell. External Heat Pump parts can be wiped with a damp cloth and domestic cleaner. (Warning: Never use cleaning agents containing sand, soda, acid or chloride as these can damage the surfaces.)

To prevent blockages in the titanium heat exchanger, ensure that the system incorporates a water and filter treatment facility. In the event of a problem occurring due to contamination, the system should be cleaned as described below. (Warning: the fins on the finned tube heat exchanger are sharp!).

Cleaning the Heat Exchanger and Pipework

Contamination in the pipes and heat exchanger can reduce the performance of the heat pumps' titanium heat exchanger. If this is the case, the pipe system and heat exchanger must be cleaned by a technician.

Use only pressurized drinking water for cleaning.

Cleaning the air system

The finned heat exchanger, fan and condensate outflow should be clear of all obstructions (leaves, twigs, etc.) before each new heating season. These can be manually removed using compressed air or by flushing with clean water.

It may be necessary to remove the unit cover and air inlet grid first.

Attention: Before opening the unit, ensure that all electrical supplies are isolated.

To prevent the evaporator and the condensate tray from being damaged, do not use hard or sharp objects for cleaning.

Under extreme weather conditions (e.g. snow drifts), ice may form on the air intake and exhaust air outlet grids. If this happens, the ice must be removed in the vicinity of the air intake and exhaust air outlet grids to ensure that the minimum air flow rate is maintained.

Winter Shutdown

To prevent frost damage to the unit when not in use the Heat Pump should be drained of all water. Failing this another form of frost protection should be considered and actioned.

Attention: The warranty does not cover damage caused by inadequate frost protection measures during the winter.

Troubleshooting

This section provides useful information for diagnosing and correcting certain problems which may occur. Before starting the troubleshooting procedure, carry out a thorough visual inspection of the unit and look for obvious defects such as loose connections or defective wiring.

Before contacting your local dealer, read this chapter carefully. It could save you time and money.



WARNING

Do not move/repair the unit yourself - Before carrying out any maintenance, service or repair work, the product must be isolated from the mains electrical supply. To prevent possible injury, only qualified engineers should carry out these works.

The hints below are for guidance only. If you cannot solve the problem, consult your installer/local dealer.

The Heat pump will not run.

Please check:

- There is a supply voltage (tripped fuse, power failure).
- The switch on the wired controller is switched on, and whether the correct set point temperature has been set.

The set temperature level cannot be reached.

Please check whether:

- The permissible operating conditions for the heat pump have been adhered to (air temperatures too high or too low).
- The air inlet or outlet area is blocked, restricted or very dirty.
- There are closed valves or stop-cocks in the water pipes.

The timer works but the programmed actions are executed at the wrong time (e.g. 1 hour too late or too early).

Please check whether:

- The clock and the day of the week are set correctly, adjust if necessary.

If you cannot correct the fault yourself, please contact Pentair for after-sales service.

System Protections / Error Codes

When an error occurs or the protection mode is set automatically, the wired controller will display an error code as below.

Code	Failure	Possible reasons	Remedy
Er01	Phase Dislocation	Wrong connection of live wires	Reverse position of 2 of the live wires (3-Phase only).
Er02	Phase Loss	Live wires loose, or without power.	1) Check if wires are loose. 2) Check if any phase is without power (use a multimeter to check voltage).

Code	Failure	Possible reasons	Remedy
Er03	Water flow switch failure	<ol style="list-style-type: none"> 1) Inadequate water flow 2) Water flow switch damaged 3) Main PCB damaged 	<ol style="list-style-type: none"> 1) Check the pump 2) Replace the water flow switch 3) Replace the PCB
Er04	Anti-freeze protection in winter	This function occurs when ambient temp is too low.	No action needed
Er05	High pressure protection	<ol style="list-style-type: none"> 1) Inadequate flow rate 2) Uncompressed gas in refrigerant system 3) Overcharge with refrigerant 4) Water temp setting too high 5) Poor connection of pressure switch 6) Pressure switch failure 7) Main PCB damaged 	<ol style="list-style-type: none"> 1) Check pump and water control valve 2) Discharge and then recharge the refrigerant 3) Discharge some refrigerant 4) Set lower water temp 5) Reconnect the switch 6) Replace the pressure switch 7) Replace the PCB
Er06	Low pressure protection	<ol style="list-style-type: none"> 1) Undercharged refrigerant 2) Capillary block 3) Poor connection of pressure switch 4) Pressure switch failure 5) Main PCB damaged 	<ol style="list-style-type: none"> 1) Add some refrigerant 2) Replace the capillary 3) Reconnect the switch 4) Replace the pressure switch 5) Replace the PCB
Er09	Communication Fail	Communication failure between the LCD and PCB	<ol style="list-style-type: none"> 1) Check the wire connection between the LCD and PCB. 2) Replace LCD.
Er12	High compressor exhaust gas temp protection	<ol style="list-style-type: none"> 1) Refrigerant Undercharged 2) Possible reasons as Er05 	<ol style="list-style-type: none"> 1) Add some refrigerant 2) Similar corrections as Er05
Er15	Inlet water temp sensor failure	<ol style="list-style-type: none"> 1) Sensor open circuit 2) Sensor short circuit 3) Main PCB damaged 	<ol style="list-style-type: none"> 1) Check the sensor connection 2) Replace the sensor 3) Replace the main PCB
Er16	Coil temp sensor failure	<ol style="list-style-type: none"> 1) Sensor open circuit 2) Sensor short circuit 3) Main PCB damaged 	<ol style="list-style-type: none"> 1) Check the sensor connection 2) Replace the sensor 3) Replace the main PCB
Er18	Compressor exhaust gas temp. sensor failure	<ol style="list-style-type: none"> 1) Sensor open circuit 2) Sensor short circuit 3) Main PCB damaged 	<ol style="list-style-type: none"> 1) Check the sensor connection 2) Replace the sensor 3) Replace the main PCB

System Protections / Error Codes (Continued)

Code	Failure	Possible reasons	Remedy
Er21	Ambient temp sensor failure	<ol style="list-style-type: none"> 1) Sensor open circuit 2) Sensor short circuit 3) Main PCB damaged 	<ol style="list-style-type: none"> 1) Check the sensor connection 2) Replace the sensor 3) Replace the main PCB
Er23	Low outlet water temp protection under cooling mode	<ol style="list-style-type: none"> 1) Inadequate water flow rate 2) Overflow inlet water temp 3) Main PCB damaged 	<ol style="list-style-type: none"> 1) Check the water filter and water circuit (no block) 2) Adjust the setting temp to normal working range 3) Replace the main PCB
Er27	Outlet water temp sensor failure	<ol style="list-style-type: none"> 1) Sensor open circuit 2) Sensor short circuit 3) Main PCB damaged 	<ol style="list-style-type: none"> 1) Check the sensor connection 2) Replace the sensor 3) Replace the main PCB
Er29	Compressor suction gas temperature sensor failure	<ol style="list-style-type: none"> 1) Sensor open circuit 2) Sensor short circuit 3) Main PCB damaged 	<ol style="list-style-type: none"> 1) Check the sensor connection 2) Replace the sensor 3) Replace the main PCB
Er35	Compressor high current protection	<ol style="list-style-type: none"> 1) Inadequate water flow rate under heat mode 2) If ambient temp is exceedingly high under heat mode 3) If fan motor broken under cool mode 	<ol style="list-style-type: none"> 1) Check pump, filter and water circuit (no block) 2) Check ambient/inlet/outlet water temps 3) Check compressor exhaust and suction gas temps 4) Check fan
Er44	Low ambient temperature protection	This function occurs when ambient temp is too low.	Check if ambient temp is below -10°C
Er45	High outlet water temp protection under heat mode	<ol style="list-style-type: none"> 1) Inadequate water flow rate 2) Set outlet water temp is too high 3) Outlet water temp sensor or main PCB damaged 	<ol style="list-style-type: none"> 1) Check pump, filter and water circuit (no block) 2) Adjust set outlet water temp to normal working range 3) Replace outlet water temp sensor or main PCB

Replacement Parts

ULTRATEMP® HX HEAT PUMP

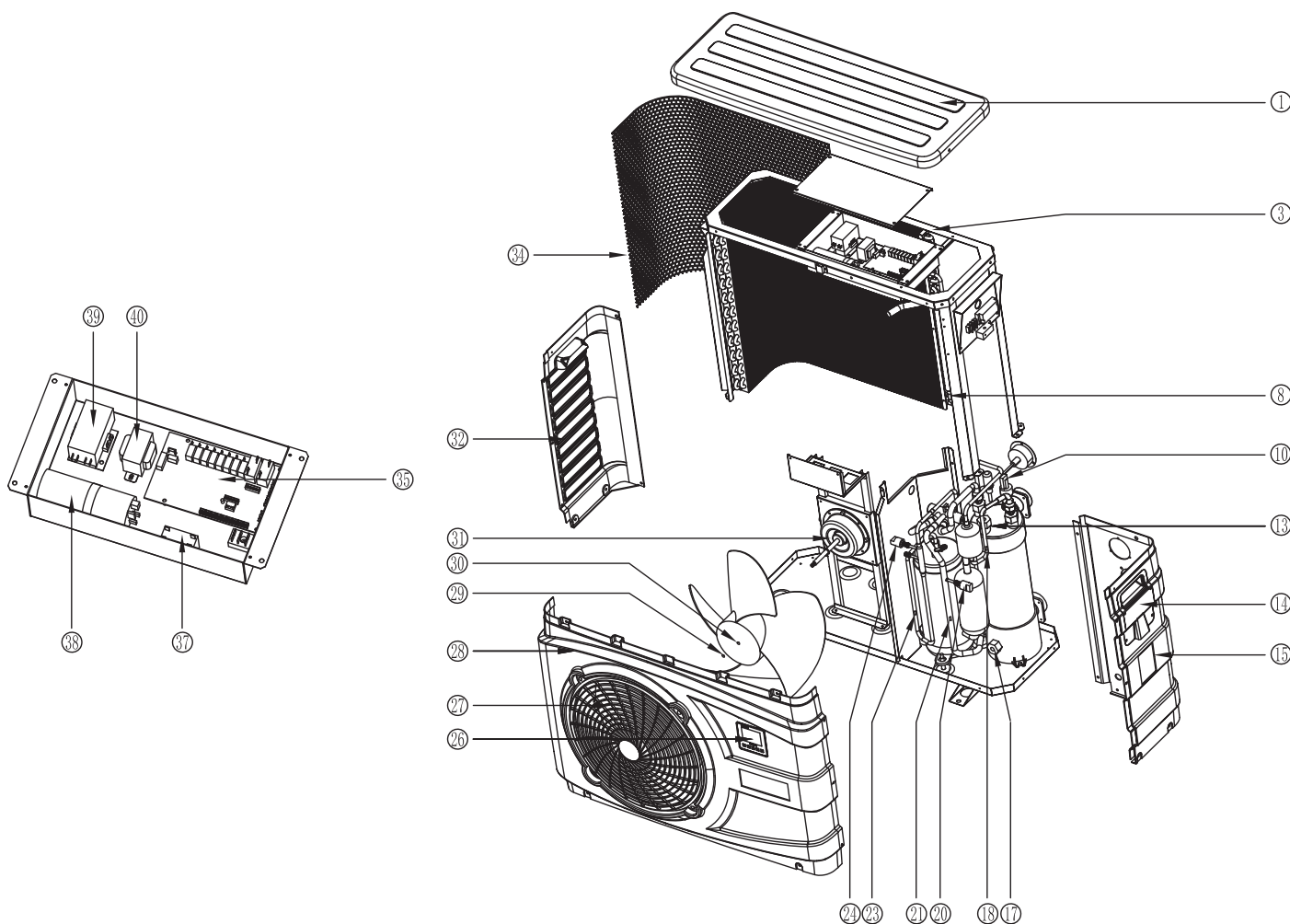

Item	Part No.	Description
ULTRATEMP HX REPLACEMENT PARTS		
1	803100	TOP COVER (9kw & 12kW)
1	801326	TOP COVER (15kW, 17kW & 21kW)
3	803101	AMBIENT AIR TEMP SENSOR
8	803102	COIL TEMP SENSOR
10	803103	FLOW SWITCH
13	803104	OUTLET WATER TEMP SENSOR
14	803105	HANDLE (9kw & 12kW)
14	803154	HANDLE (15kW, 17kW & 21kW)
15	803106	RIGHT PANEL (9kw & 12kW)
15	801327	RIGHT PANEL (15kW, 17kW & 21kW)
17	803107	INLET WATER TEMP SENSOR
18		NOT USED
20	803109	LOW PRESSURE SWITCH
21	803110	COMPRESSOR SUCTION GAS TEMP SENSOR
23	803111	COMPRESSOR EXHAUST GAS TEMP SENSOR
24	803112	HIGH PRESSURE SWITCH
26	803113	LCD CONTROLLER
27	803114	GRILL (9kW & 12kW)

Item	Part No.	Description
27	803153	GRILL (15kW, 17kW & 21kW)
28	803115	FRONT PANEL (9kw & 12kW)
28	801328	FRONT PANEL (15kW, 17kW & 21kW)
29&30	803117	FAN BLADE & NUT (9kW & 12kW)
29&30	803134	FAN BLADE & NUT (15kW, 17kW & 21kW)
31	803118	FAN MOTOR & NUT (9kw & 12kW)
31	803135	FAN MOTOR & NUT (15kW, 17kW & 21kW)
32	803119	LEFT PANEL (9kw & 12kW)
32	801329	LEFT PANEL (15kW, 17kW & 21kW)
34	803120	REAR PROTECTION NET (9kw & 12kW)
34	801330	REAR PROTECTION NET (15kW, 17kW & 21kW)
35	803121	PCB MAIN BOARD
37	803122	FAN CAPACITOR 4uF (all units)
38	803123	COMPRESSOR CAPACITOR 50uF (9kW & 12kW)
38	803131	COMPRESSOR CAPACITOR 55uF (15kW)
38	803132	COMPRESSOR CAPACITOR KIT 80uF+98uF (17kW)
38	803133	COMPRESSOR CAPACITOR KIT 60uF+98uF (21kW)
39	803124	AC CONTACTOR
40	803125	TRANSFORMER

Wiring Diagrams

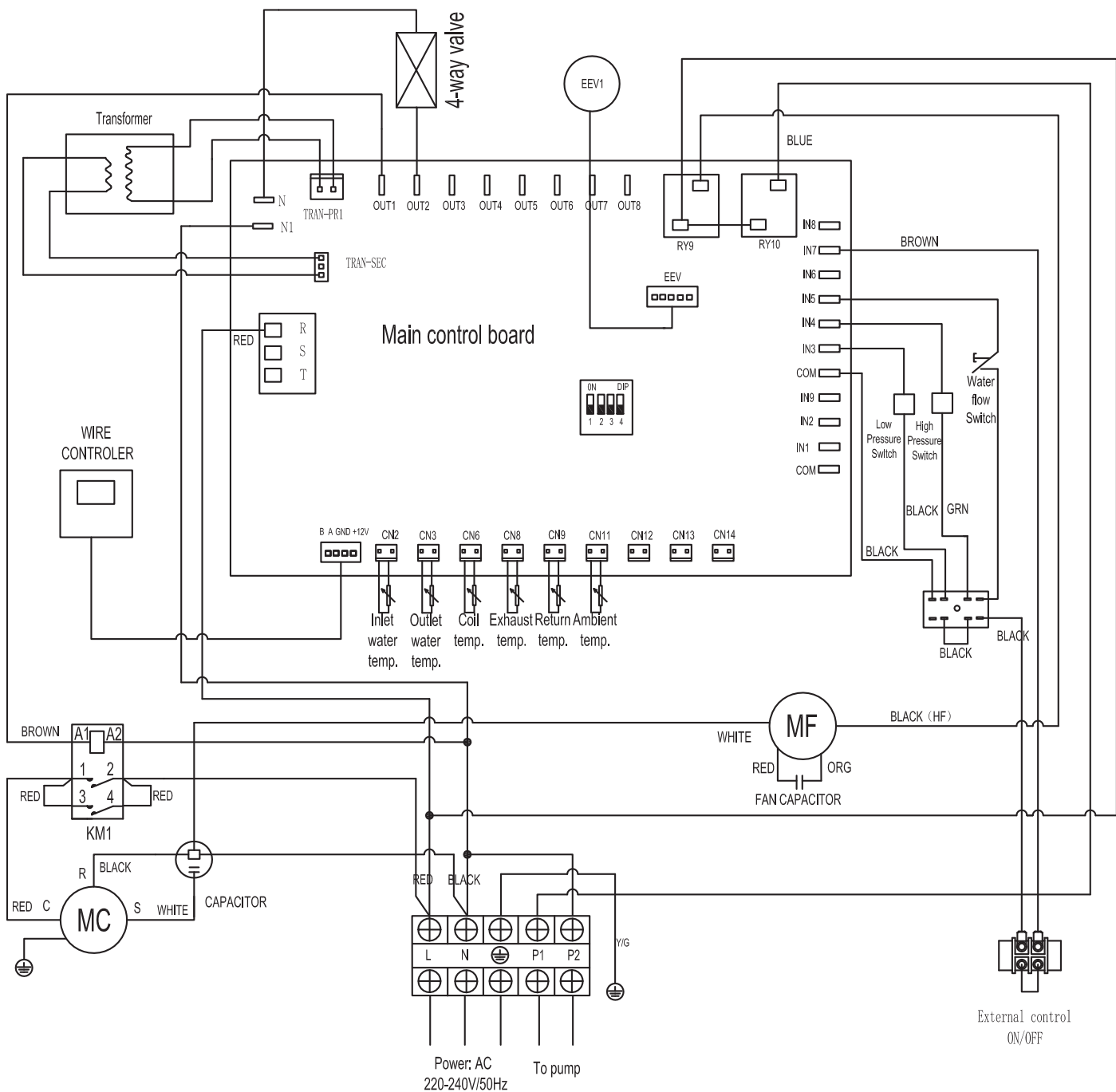

Wiring Diagram: UltraTemp 9.5kW, 12kW & 15kW models

Wiring Diagrams Continued

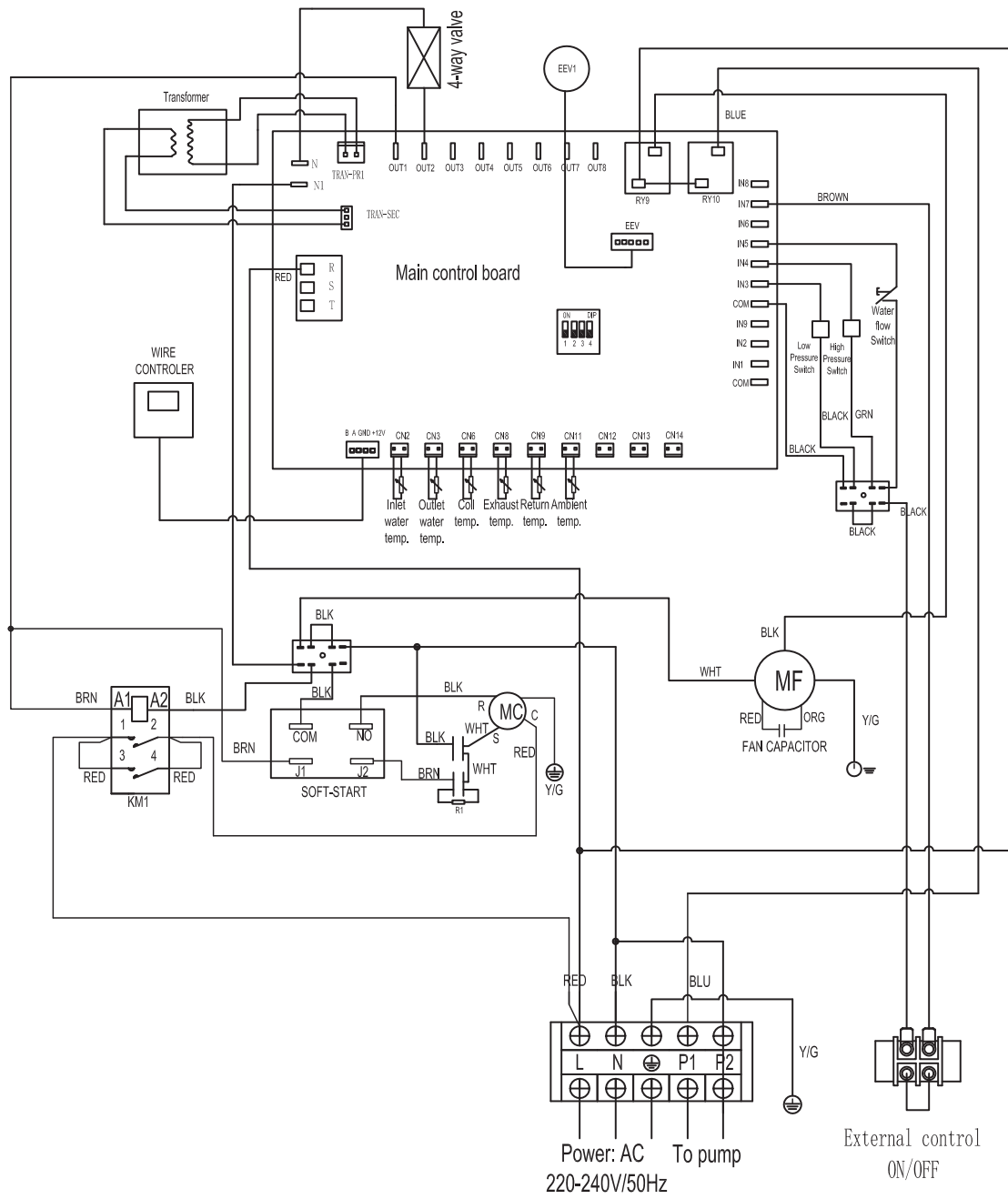

Wiring Diagram: UltraTemp 17kW & 21kW models

Environmental Information

This equipment contains fluorinated greenhouse gases covered by the Kyoto Protocol. It should only be serviced or dismantled by professional trained engineers.

This equipment contains R410A refrigerant in the amount as stated in the specification. Do not vent R410A into the atmosphere: R410A, is a fluorinated greenhouse gas with a Global Warming Potential (GWP) = 1975.

Disposal Requirements

Dismantling of the unit, treatment of the refrigerant, of oil and of other parts must be carried out in accordance with relevant local and national legislation.

Do not try to dismantle the system yourself: the dismantling of the system, treatment of the refrigerant, of oil and other parts must be done by a qualified installer in accordance with relevant local and national legislation.

Units must be treated at a specialized treatment facility for re-use, recycling and recovery. By ensuring that this product is disposed of correctly, you will help to prevent potential negative consequences for the environment and human health. **Please contact the your local council for more information on correct disposal of Pre-charged HCFC equipment.**

This product should not be mixed with unsorted household waste.

ULTRATEMP[®] HX

High Performance Heat Pump



IMPORTANT

Please attach your sales invoice/docket here as proof of purchase should warranty service be required.

Purchased from:.....

Purchase date: Serial No.: Model No.:

Head Office Pentair AU/NZ:

1-21 Monash Drive
Dandenong South,
VIC 3175

Australia

National customer service:	Phone:	1300 137 344
	Fax:	1800 006 688
National dealer locator:	Phone:	1800 664 266
Email:	au.sales@pentair.com	
Web:	www.pentairpool.com.au	

International

Phone:	+61 3 9709 5800
Fax:	+61 3 9709 5888

L300286 A0717

© 2017 Information contained here-in remains the property of Pentair Australia Pty. Ltd. Any reproduction, display, publication, modification or distribution is strictly prohibited without the prior written permission of Pentair Australia Pty. Ltd.

Disclaimer:

Every endeavour has been made to publish the correct details in this document. No responsibility will be taken for errors, omissions or changes in product descriptions, specifications. Pentair Australia reserves the right to change specifications.