

OWNER'S MANUAL



onga[®]

Pentair Water



For the Installation, Operation and Service of

Hammer  **Head**
The All-in-One Pool Cleaner

Should the installer or owner be unfamiliar with the correct installation or operation of this type of equipment you should contact the distributor/manufacturer for the correct advice before proceeding with the installation or operation of this product.

Table of Contents

Page

Component Checklist	3
----------------------------	---

Assembly

Suction Seal Assembly	4
-----------------------	---

Preparations

1 Backwash Rinse	5
2 Strainer Basket	

Return Line Adjustments	6
--------------------------------	---

Hose Assembly & Weights	7
------------------------------------	---

Installation	8
---------------------	---

Balancing the Hose	9
Fine Tuning	9

Maintenance	10
--------------------	----

Trouble Shooting	12
-------------------------	----

Warranty	15
-----------------	----

Component Checklist

Please note changes to the contents of this unit:
(Changed items printed in **Bold Print**)

- 1.... Cleaner Body (1)
- 2.... Suction Seal (1)
- 3.... Regulator Valve (1)
- 4.... **Elbow (90 degree) & Threaded Skimmer Plate Adaptor (1)**
- 5.... **Hose Weights (2)**
- 6.... Flow Gauge (1)
- 7.... 1m Leader Hose (1) (Blue cuffed hose)
- 8.... 1m Hose Lengths (9)
- 9.... **Adaptor Cuff (1)**

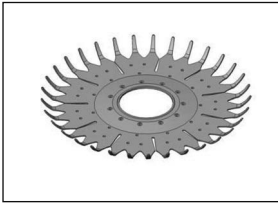
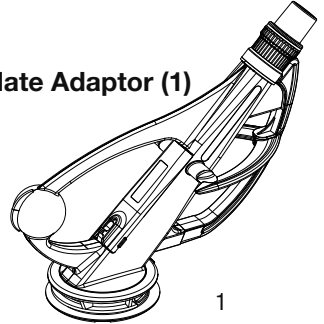

2

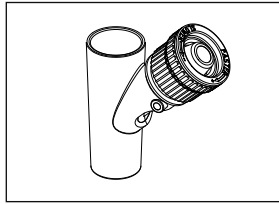

3

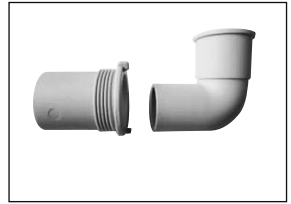

4



5



6

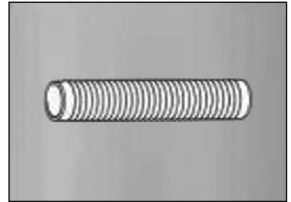

7



8



9

Assembly

Suction Seal Assembly

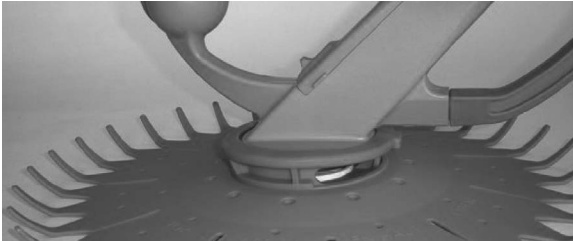

Pull Suction Seal over the cleaners Foot Pad so that it will fit properly into the Foot Pad's groove as shown in illustration #1.

Ensure that the curved tips of the Suction Seal face upwards.

Ensure that the Suction Seal rotates freely.

Weir Component Assembly

Certain Skimmer Boxes may not require the insertion of the 90 Degree Elbow.

If the first length of pool hose can be inserted into the valve.

Insert the 90 Degree Elbow into the Regulator Valve as shown in the illustration.

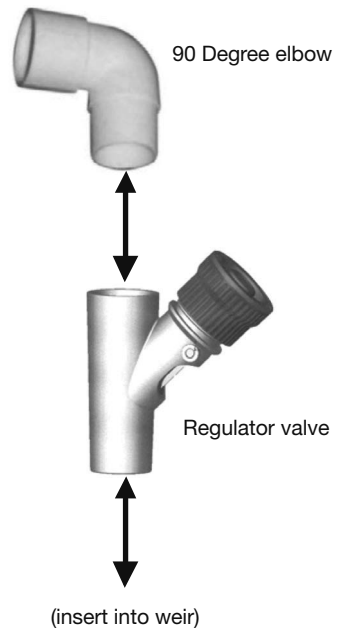

Preparations

1 Backwash Rinse:

Thoroughly backwash and rinse the filter to ensure that it is free from dirt and debris.

Switch the pump off.

Clean skimmer/weir and leaf strainer/basket. Insert the basket and vacuum lid back in weir once clean.

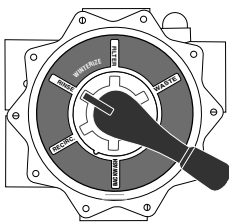

Backwash

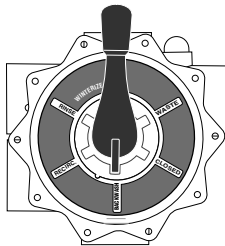

Rinse

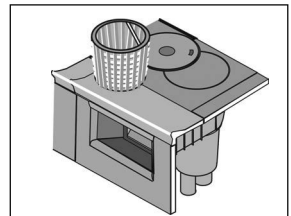

Skimmer/Weir

2 Strainer Basket:

Clean pump strainer basket. Insert the strainer basket and lid back in wet-end of pump once clean. Test pool water for correct water balance.

Close all other suction lines except the skimmer/ weir suction line that your Hammer Head pool cleaner will be connected to.

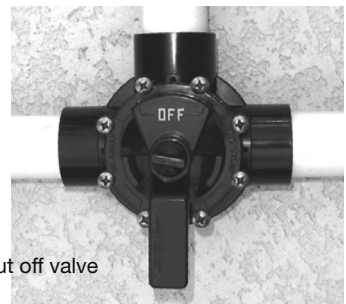
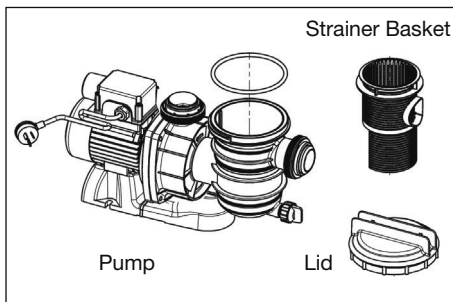

Return Line Adjustments

Important

The cleaner must move randomly throughout the pool. Water circulating at the surface will influence the hose thus limiting Cleaner's coverage.

Adjust Return Line Flow as described in diagrams below.

To adjust the Eyeball Diverters;

loosen the lock ring and redirect the Eyeball Diverters slightly downwards and also try different directions to see what works best in your pool. allow time for the body of water to settle into new pattern.

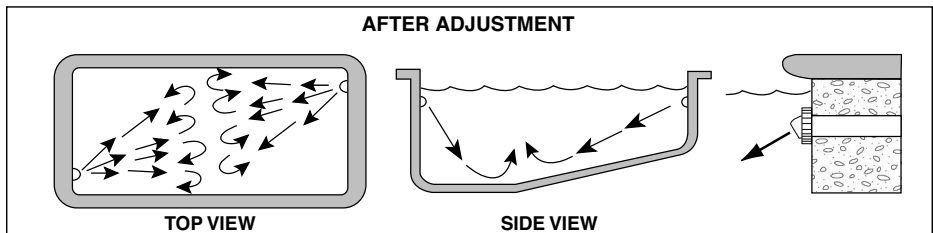
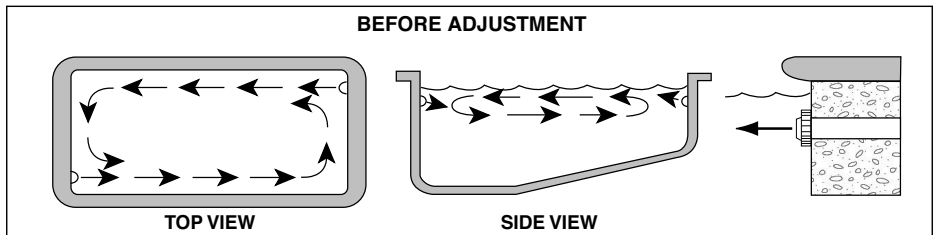

Hose Assembly & Weights

Important

The exclusive three-year warranty is only valid if the machine is operating with genuine Hammer Head hose.

N.B. Hammer Head hose is specially constructed for optimum performance and is protected by a three-year warranty against factory defect.

Twist and push the female ends to the male after dipping the ends into the pool to wet them. Push until the hose fits snugly. Do not force the hoses on, as this will hamper dismantling. Continue until you've connected all the sections you need.



The Hammer Head hose sections which must be assembled by connecting together as many hose sections as needed to reach from the skimmer/weir to the farthest point of the pool, plus one section or plus two sections if your skimmer/weir is located at the center of your pool.

N.B. The leader hose will be considered the extra length hose needed to reach from the weir to the farthest corner. As this hose is connected to the pool cleaner.

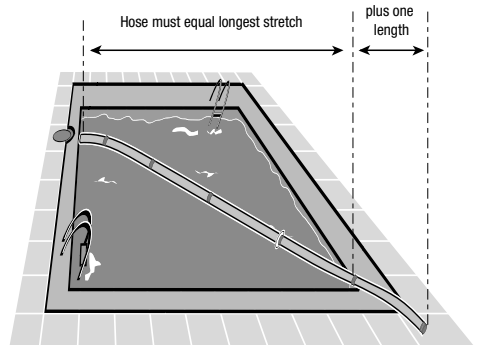

Installation

Ensure the pump and filtration system is switched off before commencing.

Insert the weir adaptors into vacuum lid.

Connect the already measured out hose sections to the Hammer Head.

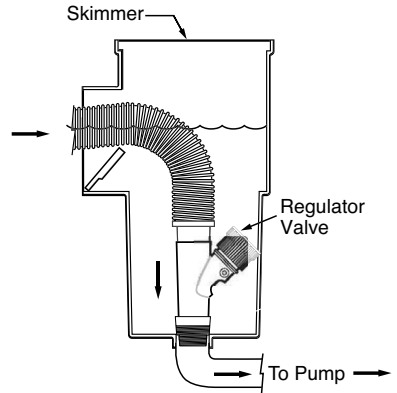

1. Insert Flow Gauge into leader hose.
2. Place hose lengths into pool (filled with water) and connect to regulator valve fitted to weir.
3. Switch on pump and regulate flow of water

IMPORTANT: The Flow Gauge is used for test purposes only and must be removed during normal operation of the Hammer Head



Switch the pump on and start adjusting the Knob of the Regulator Valve "Faster" or "Slower" until the disc indicator in the Flow Gauge settles between "maximum" and "minimum" flow.

Turn the pump off.

Remove the Flow Gauge and connect the pool cleaner to leader hose.

NOTE: optimizing the water flow does not mean maximizing the flow through the Cleaner. In fact, to insure a random pattern of travel that will enable the Cleaner to reach all areas of your pool, it is better to use less suction, not more.

Switch on your pump.
Your fully assembled Hammer Head will start pulsating immediately.

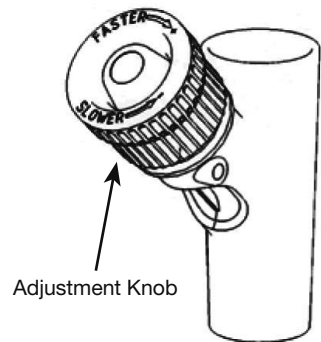

Installation continued

Balancing the Hose

You will also have to attach hose weights to the hose to neutralize the hose's buoyancy in the water. Hose weight is not required for most of the pools.

To improve cleaner's pool coverage place 1st hose weight between the 3rd and 4th hose and the 2nd hose weight between 4th and 5th hose from the cleaner.

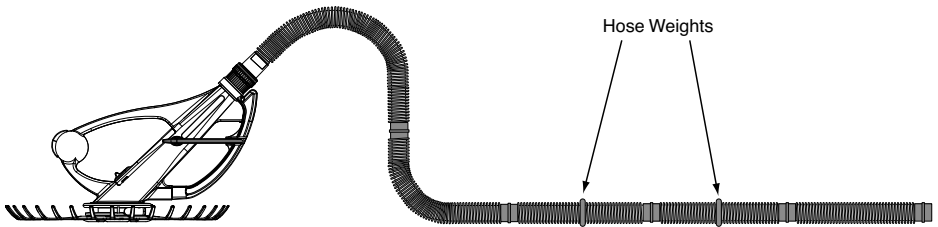

Fine Tuning

The water density in each pool may vary due to mineral and salt content.

To fine-tune the balance of your hose, try moving the 1st hose weight closer towards the 2nd hose weight to improve cleaner's pool coverage.

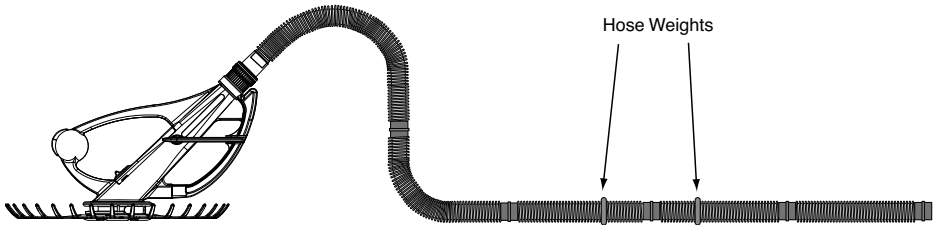

Maintenance

Your Cleaner requires very little maintenance. Check the Flapper from time to time.

1. It is quick and easy to open up the Flapper's chamber. Simply stop the pump, push the sliding lock up into open position and remove the lid. With your finger lift and inspect the Flapper and the chamber to insure that it is not obstructed by debris. See picture:
2. Place the lid back and slide the lock down to close.
3. Remove damaged or worn Flapper; no tools are required. Simply grab the Flapper, pull and waggle outward until it unclips from the steel pin. To install the new Flapper push it in firmly onto the steel pin until it snaps in place. If the Flapper is clipped in the wrong way you will not be able to close the lid.

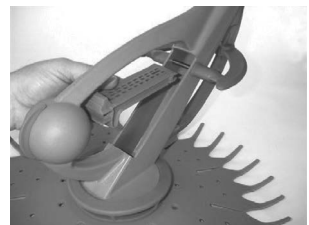
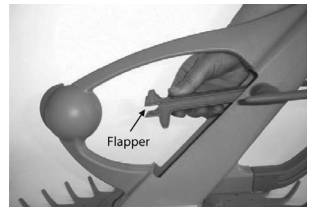
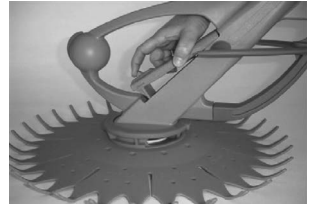

Maintenance

- Check the Suction Seal for wear. If it becomes thin and too floppy, it will impair the correct random movement of the pool cleaner and should be replaced.
- Check the footpad. It is a wearing part and should be replaced when worn.
- Inspect the Regulator Valve and flush away any debris build up.
- Clean your filter system.
- Empty the Skimmer Basket.
- Empty the Strainer Basket.
- Use your Flow Gauge to insure correct water flow for your Cleaner.
- For best results and to maintain proper operation, use only original hoses.

NOTE: Remove the Hammer Head pool cleaner from the pool before the chemical shock treatment! When not in the pool, keep the Hammer Head pool cleaner's Suction Seal flat to avoid warping.

- When people are using the pool, disconnect the Cleaner and pull it to one side of the pool.
- When storing or winterizing the Hammer Head, do not coil the hose. Lay the hose flat in an area protected from direct sunlight. It is also important to remove the Suction Seal from the Hammer Head and store it flat.
- Leaf catcher - If your pool is exposed to large quantities of leaves, we suggest purchasing and installing a leaf catcher. a leaf catcher will provide more debris loading capacity and also provides a water by-pass when the leaf bag is full. It is very important that the pump will not starve for water!

Trouble Shooting

Problem: Cleaner is sluggish or has stopped operating.

- Solution:**
- Check Hammer Head for blockage inside the Oscillator chamber.
 - Clean your filter system, empty pump basket and empty skimmer/weir basket.
 - Clean cartridge inside cartridge filter, if one is installed.
 - Inspect the Regulator Valve and flush away any debris buildup.
 - Check the footpad under the Hammer Head for wear.
 - Make sure the curved tips of the suction seal is facing upwards.
 - Ensure that the skimmer/weir vacuum lid is fitted correctly and check for cracks.
 - Check the hose for blockage.
 - Check the hose for leaks by lifting each section above water while pump is running.
 - Using your Flow Gauge, verify proper water flow to your Cleaner.
 - Backwash and rinse system.
 - Run your sand filter on bypass/circulate. If Hammer Head performs better, consult a pool shop in your area.

Problem: Cleaner gets stuck on steps.

- Solution:**
- Adjust the Eyeball Diverter of the return flow towards the problem area to guide the Cleaner away from the steps.
 - Verify proper hose length and correct position of the Hose Weights.
 - Remove or add one hose section.
 - Using your Flow Gauge, verify proper water flow to your Cleaner.
 - Using your Flow Gauge, Increase or decrease the flow to your cleaner with-in the maximum/minimum range by adjusting the valve.
 - Check the footpad under the Hammer Head pool cleaner for wear.

Problem: Cleaner travels in a repetitive pattern.

- Solution:**
- Adjust Eyeball Diverters downwards.
 - Verify proper hose length and correct position of the Hose Weights.
 - Remove or add one hose section.
 - Using your Flow Gauge, verify proper water flow to your Cleaner.
 - Inspect the Regulator Valve and flush away any debris buildup.
 - Check that the hose sections are straight; if not straighten up the coiled hose and lay it in the warm sun for day or two.
 - Ensure the swivel on top of the Hammer Head pool cleaner is rotating freely and is screwed on securely.

Trouble Shooting

Problem: Cleaner does not stick/climb onto the wall.

- Solution:**
- Using your Flow Gauge, verify proper water flow to your Cleaner.
 - Increase the water flow slightly, by adjusting the valve to faster.
 - Verify proper hose length and correct position of the Hose Weights.
 - Ensure the curved tips of the suction seal is facing upwards.
 - Check the footpad under the pool cleaner for wear.
 - Inspect the suction seal for wear.
 - Adjust Eyeball Diverters downwards
 - Clean your filter system, empty pump basket and empty skimmer/weir basket.
 - Run your sand filter on bypass/circulate. If Hammer Head performs better, consult a pool shop in your area.
 - Clean cartridge inside cartridge filter, if one is installed.
 - Ensure the radius from the floor to the wall is not too small. If so, you have what is termed a “Square bottomed pool” – in which the Hammer Head is unable to climb the walls.

Problem: Cleaner climbs out of pool and draws in air.

- Solution:**
- Ensure there is a valve installed in the skimmer/weir.
 - Using your Flow Gauge, verify proper water flow to your Cleaner.
 - Inspect the Regulator Valve and flush away any debris buildup.
 - Verify proper hose length and correct position of the Hose Weights.

Problem: Cleaner ties itself in knots.

- Solution:**
- Ensure the swivel on top of the Hammer Head is rotating freely and is screwed on securely.
 - Check that the hose sections are straight; if not straighten up the coiled hose and lay it in the warm sun for day or two.
 - Using your Flow Gauge, verify proper water flow to your Cleaner.
 - Inspect the Regulator Valve and flush away any debris buildup.

Trouble Shooting

Problem: Cleaner leaves patches.

- Solution:**
- Ensure the swivel on top of the Hammer Head is rotating freely and is screwed on securely.
 - Adjust Eyeball Diverters downwards.
 - Check the footpad under the Hammer Head for wear.
 - Verify proper hose length and correct position of the Hose Weights.
 - Check that the hose sections are straight; if not straighten up the coiled hose and lay it in the warm sun for day or two.
 - Time switch is not running long enough. Reset time switch.

Problem: Cleaner only cleans the walls.

- Solution:**
- Ensure there is a valve installed in the skimmer/weir.
 - Using your Flow Gauge, verify proper water flow to your Cleaner.
 - Inspect the Regulator Valve and flush away any debris buildup.
 - Check the footpad under the pool cleaner for wear.

Problem: Cleaner sticks on walls and floors.

- Solution:**
- Ensure there is a valve installed in the skimmer/weir.
 - Using your Flow Gauge, verify proper water flow to your Cleaner.
 - Inspect the Regulator Valve and flush away any debris buildup.
 - Check the footpad under the Hammer Head for wear.

Problem: Cleaner not sitting flat on bottom. Solution:

- Ensure there is a valve installed in the skimmer/weir.
- Using your Flow Gauge, verify proper water flow to your Cleaner.
- Inspect the Regulator Valve and flush away any debris buildup.
- Ensure the swivel on top of the Hammer Head is rotating freely and is screwed on securely.
- Adjust Eyeball Diverters downwards.
- Verify proper hose length and correct position of the Hose Weights.

Notes

A series of horizontal dotted lines for writing notes.

IMPORTANT

Please attach your sales invoice/docket here as proof of purchase should warranty service be required.

Please do not return Warranty Form to Pentair Australia - please retain for your records.

Purchased From

Purchase Date..... Serial No..... Model No.....



Head Office

Pentair AU/NZ: 1-21 Monash Drive,
Dandenong South, Vic 3175

Australia

National Customer Service: Phone: 1300 137 344
Fax: 1800 006 688
National Dealer Locator: Phone: 1800 664 266
Email: au.sales@pentair.com
Web: www.pentair.com.au

New Zealand

National Customer Service: Phone: 0800 654 112
Fax: 0800 806 642
National Dealer Locator: Phone: 0800 664 269
Email: nz.sales@pentair.com
Web: www.pentair.co.nz

International Australia/New Zealand

Phone: +61 3 9709 5800
Fax: +61 3 9709 5888

© Information contained here-in remains the property of Pentair Water Pty Ltd. Any reproduction, display, publication, modification or distribution is strictly prohibited without the prior written permission of Pentair Water Pty Ltd.

Disclaimer: Every endeavour has been made to publish the correct details in this data sheet. No responsibility will be taken for errors, omissions or changes in product specifications. Pentair Water reserves the right to change specifications