

**Thermo Fisher Scientific General Purpose-Counter Top Series  
Laboratory Freezers**

**User Manual**

**General Purpose Models: MF02PA-SAEE-TS**

327905H01    Rev. B    October 2016

**Visit us online to register your warranty**  
**[www.thermofisher.com](http://www.thermofisher.com)**

**thermo**scientific

**IMPORTANT** Read this instruction manual. Failure to follow the instructions in this manual can result in damage to the unit, injury to operating personnel, and poor equipment performance.

**CAUTION** All internal adjustments and maintenance must be performed by qualified service personnel.

Material in this manual is for informational purposes only. The contents and the product it describes are subject to change without notice. Thermo Fisher Scientific makes no representations or warranties with respect to this manual. In no event shall Thermo be held liable for any damages, direct or incidental, arising from or related to the use of this manual.

© 2016 Thermo Fisher Scientific Inc. All rights reserved.

# Table of Contents

<b>Intended Use and Special Warnings .....</b>	<b>2</b>
<b>Positioning &amp; Safely Using your GP Series Freezer .....</b>	<b>3</b>
<b>Transporting &amp; Moving your GP Series Freezer .....</b>	<b>4</b>
<b>Energy Saving Tips .....</b>	<b>4</b>
<b>Important Information.....</b>	<b>5</b>
<b>Product Information.....</b>	<b>6</b>
Environmental Operating Conditions .....	6
<b>Product Details.....</b>	<b>7</b>
<b>Controller Overview &amp; Operation .....</b>	<b>8</b>
Anticipated Operational/Field Environment .....	8
Default Settings.....	9
Viewing & Resetting Minimum & Maximum Temperatures .....	9
Changing Factory Set Point .....	10
Switching Temperature Scale Between Celsius (°C) and Fahrenheit (°F) .....	10
Changing Remote Alarm Contacts .....	11
<b>Warning Alarms .....</b>	<b>12</b>
<b>Remote Alarm Contacts .....</b>	<b>13</b>
<b>Access Port.....</b>	<b>14</b>
<b>Maintenance &amp; Service Of Your GP Series Freezer .....</b>	<b>15</b>
Defrosting .....	15
Cleaning .....	16
Storage .....	16
<b>Electrical Connection .....</b>	<b>17</b>
<b>Troubleshooting .....</b>	<b>18</b>



This symbol used alone indicates important operating instructions which reduce risk of injury or poor performance of the unit. Please read the manual completely before use.

In this manual, the words **WARNING** and **CAUTION** mean the following:



**WARNING:** A situation which, if not avoided, could result in serious injury or death.



**CAUTION:** A situation which, if not avoided, may result in minor or moderate injury, impaired performance, or damage to the equipment.



**CAUTION:** Before installing, using or maintaining this product, please be sure to read this manual and product warning labels carefully. Failure to follow these instructions may cause this product to malfunction, which could result in injury or damage.



**WARNING:** Potential danger of electric shock which, if not avoided, could result in serious injury or death.

# 1 Intended Use and Special Warnings

This equipment is tested in compliance with established regulations and then shipped ready for use. This equipment is intended for general purpose cold storage and is not to be used in the presence of explosive gases or mixtures and / or close to sources with high magnetic or electric fields.



**WARNING:** This unit is not a medical device, and it has not been registered with a medical device regulatory body (e.g. FDA). The product has not been evaluated for the storage of samples for diagnostic use, nor for samples to be re-introduced into the body.

*If the equipment is used in a manner not specified by the manufacturer, the protection provided by the equipment may be impaired.*

Thank you for purchasing this GP Series cold storage equipment. Before you first use this laboratory freezer please carry out the following actions:

- Check that the freezer has not been damaged in any way during transportation.
- If any damage is found it must be reported to your local dealer immediately.
- Ensure all packaging has been removed, including cardboard, polystyrene and any tape used to hold shelves in place for transportation.
- The freezer has been cleaned prior to dispatch; however, we advise that it should be cleaned using lukewarm water containing a mild detergent and a soft cloth.
- We recommend that the freezer should be left in an upright position for 24 hours prior to switching on.
- This equipment is not intended for use by persons (including children) with reduced physical, sensory or mental capabilities, or lack of experience and knowledge, unless they have been given supervision or instruction concerning use of the equipment by a person responsible for their safety.
- Children should not be allowed to play with the equipment.

## 2 Positioning & Safely Using your GP Series Freezer



**CAUTION:** To reduce the risk of the unit falling over, do not tip beyond 10°.

- Make sure the equipment is placed in a dry, well ventilated site, away from heat sources.
- The equipment must be placed on a level surface. If necessary, adjust the feet on the product so the equipment remains level during operation.
- The equipment should have sufficient clearance around it to provide adequate ventilation – 2" at each side, 3" at the rear and 1" at the top.
- Before ANY maintenance activity, pull the plug out of the socket by gripping the plug, DO NOT pull on the plug cord.
- DO NOT use extension cords.
- If the main power supply cord is damaged, it should be replaced by a qualified service engineer.
- DO NOT attempt any repairs to the equipment yourself (apart from those highlighted in the Maintenance and Service Section). Repairs carried out by someone without the relevant training are putting their personal safety at risk and will invalidate your warranty.



**CAUTION:** Use this equipment only in the way described in the product literature and in this manual.

- Before using it, verify that this equipment is suitable for its intended use. If the equipment is used in a manner not specified by the manufacturer, the protection provided by the equipment may be impaired.
- DO NOT modify system components, especially the controller. Use Thermo Scientific exact replacement equipment or parts. Before use, confirm that the product has not been altered in any way.
- Equipment must be properly grounded in conformity with National and Local Electrical codes. Never connect the equipment to overloaded power sources.
- Disconnect the unit from all power sources before cleaning, troubleshooting, or performing other maintenance on the product or its controls.

### **3 Transporting & Moving your GP Series Freezer**

The freezer must always be moved in the vertical position. The cabinet must not be tilted anymore than 10°. In the event that the cabinet is tilted more than 10°, the power supply must not be connected until the equipment has stood upright for at least 24 hours.

### **4 Energy Saving Tips**

This equipment is cooled by energy-efficient R600a refrigerant. To keep running costs as low as possible always:

- Position the equipment away from heat sources.
- Make sure the air can circulate freely around the equipment, don't block ventilation grid.
- Ensure that products being stored are below room temperature before placement inside the unit.
- Make sure the door is opened as little as possible while in use and closed as quickly as possible to prevent unnecessary temperature fluctuations.

## 5 Important Information

The freezer contains environment-friendly, non ozone depleting refrigerant R600a. As R600a is a flammable gas, it is important to avoid damage to the refrigeration circuit during transport and installation. If the refrigeration circuit is damaged, avoid using a naked flame in the vicinity of the equipment and connecting power to the equipment. Also make sure there is good ventilation in the room. If you are in doubt, please contact your supplier.



**CAUTION:** Keep ventilation openings, in the equipment enclosure or in the built-in structure, clear of obstruction.



**CAUTION:** Do not use mechanical devices or other means to accelerate the defrosting process, other than those recommended by the manufacturer.



**WARNING:** Do not damage the refrigerant circuit.

**Note** *The power cord serves as the main disconnecting device.*



## 6 Product Information

This freezer has been designed and built with the intention of the product being used within a laboratory and is designed to store contents between -18°C to -30°C (-0.4°F to -22°F).

See below for specific product information:

Model	Height Inches (mm)	Width Inches (mm)	Depth Inches (mm)	Weight lbs (Kg)	Refrigerant type	Ambient/ Room working temperat ure	No. of shelves	Door type
MF02PA-S AEE-TS	20.8 (528)	18.7 (475)	19.7 (500)	37.4 (17)	R600a	1	1	Solid

### 6.1 Environmental Operating Conditions

Pollution degree	2
Installation category	II
Altitude	2000 m MSL (mean sea level)
Humidity	max 80% -non condensing
Voltage tolerance	±10%
Ambient temperature	15°C to 32°C (59°F to 90°F)
Product usage	Indoor use only

## 7 Product Details

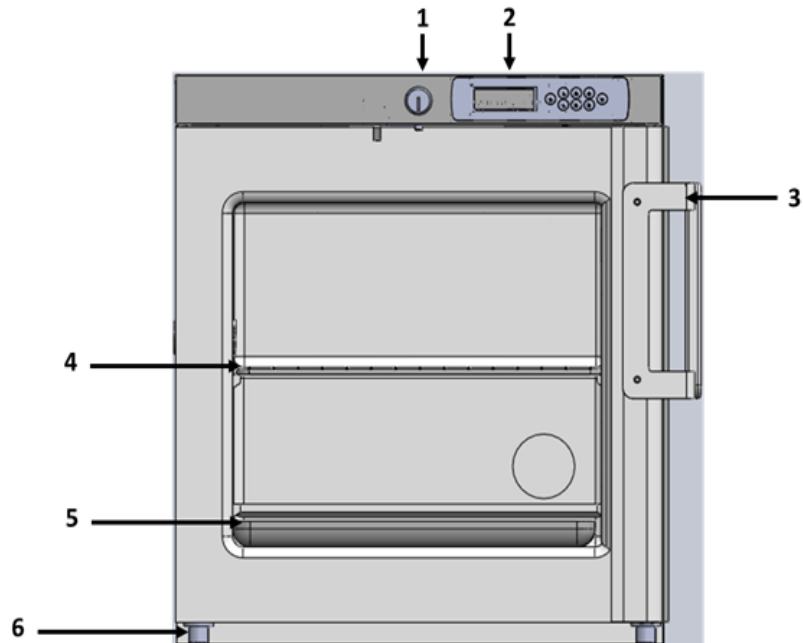

1. Lock
2. Electronic Controller
3. Door Handle
4. Wire Shelf
5. Plastic Tray
6. Adjustable foot (2 at front of equipment)

Contact your local representative for information on spare parts.

## 8 Controller Overview & Operation

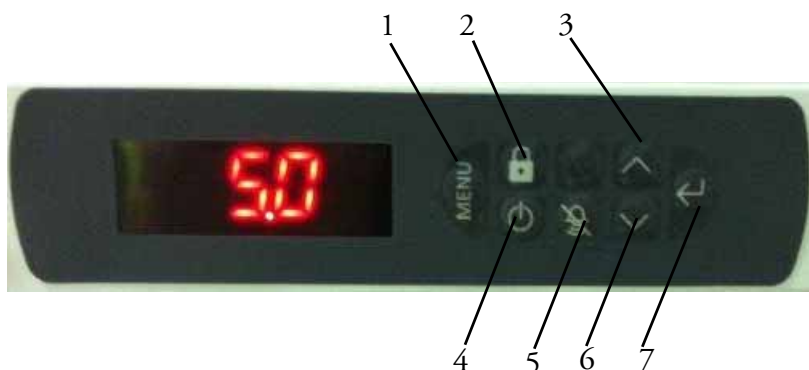

1. Menu
2. Lock keypad
3. Maximum temperature / Up
4. Power
5. Mute
6. Minimum temperature / Down
7. Set / Enter

### 8.1 Anticipated Operational/Field Environment







Environment	Units	Nominal	Minimum	Maximum
Minimum Starting Temperature	°C	15		
Lab / Room Relative Humidity	% RH	50		80
Lab / Room Temperature	°C	20	15	32
Voltage “V”	VAC	115	-10%	+10%
Frequency “V”	Hz	60		
Design Life Expectancy	years	7		
Altitude		Up to 2000 m		
Fuse Rating		10A, 250V, High Breaking Capacity, Fast Acting		
Transient Over Voltages		Up to the levels of “overvoltage category II”		
Pollution Degree		Pollution degree 2 (in most cases)		

## 8.2 Default Settings

Parameter	Description	Default Setting
AL	Low Temperature Alarm Threshold	-30°C (-22°F)
AH	High Temperature Alarm Threshold	-11°C (12.2°F)
/5	Temperature Setting °C/°F	0 for °C
St	Temperature Set Point	-20°C (-4°F)
r1	Maximum Set Point	-19°C (-2.2°F)
r2	Minimum Set Point	-21°C (-5.8°F)
rd	Control Delta	2°C (35.6°F)













When prompted enter Password as “22”.

## 8.3 Viewing & Resetting Minimum & Maximum Temperatures













Function	Press	Hold button(s) down for	Example screen
To view Maximum temperature <i>N.B. Display maximum since last reset</i>		3 seconds	
To view Minimum temperature <i>N.B. Display minimum since last reset</i>		3 seconds	
To reset temperature <i>N.B. This will delete all previous values</i>	 	3 seconds	

## 8.4 Changing Factory Set Point













(The set point is the point at which the normally unit holds the temperature at; in rare circumstances such as high/low room temperatures it may be necessary to adjust this slightly. Changing the factory setting is not recommended.)

Function	Press	Hold button(s) down for	Example screen
To change the set point		3 seconds	
followed by		Once	
followed by		1 second	
followed by	 /  (Increase/Decrease)	upto 10 times	
followed by		1 second	
followed by		5 seconds	
<i>Note: Set point can be increased or decreased in <math>\pm 0.1^{\circ}\text{C}</math> increments by a MAXIMUM of <math>1^{\circ}\text{C}</math>.</i>			

## 8.5 Switching Temperature Scale Between Celsius ( $^{\circ}\text{C}$ ) and Fahrenheit ( $^{\circ}\text{F}$ )

Function	Press	Hold button(s) down for	Example screen
To change temperature scale		3 seconds	
followed by		Two times	
followed by		1 second	
followed by	 / 	Once	
followed by		1 second	
followed by		5 seconds	

## 8.6 Changing Remote Alarm Contacts

Function	Press	Hold button(s) down for	Example screen
To change the alarm contact state		3 seconds	
followed by		Three times	
followed by		1 second	
followed by	 / 	Once	
followed by		1 second	
followed by		5 seconds	
<i>Note: NO = Normally Open, NC = Normally Closed.</i>			













## 9 Warning Alarms

This freezer has been designed to provide both an audible and visual alarm should any of the following situations occur:













- Internal temperature goes outside the set parameters, either too high or too low.

If these alarms occur, this can be muted by pressing  on the controller.

High Alarm Section:

Function	Press	Hold button(s) down for	Example screen
To change the high alarm setpoint		5 seconds	
followed by		6 times	
followed by		1 second	
followed by	 /  (Increase/Decrease)	Untill required high alarm set point	
followed by		1 second	
followed by		5 seconds to go back to standard display	

Low Alarm Section:

Function	Press	Hold button(s) down for	Example screen
To change the low alarm setpoint		5 seconds	
followed by		7 times	
followed by		1 second	
followed by	 /  (Increase/Decrease)	Untill required low alarm set point	
followed by		1 second	
followed by		5 seconds to go back to standard display	

## 10 Remote Alarm Contacts

All GP series laboratory freezers include remote alarm contacts and these terminal contacts enable the user to connect to a remote control station; these contacts can be found on the rear of the cabinet.



**CAUTION:** These contacts must only be accessed by a competent electrician.

In order to use these contacts the following must be carried out:

1. The freezer **MUST** be disconnected from the power supply before removing the terminal cover.
2. Unscrew the cover (*Figure 1*) on the right hand side of the rear of the cabinet to expose the connectors (*Figure 2*).



**Figure 1.**



**Figure 2.**

3. Use the right hand outer positions that correspond to the left hand cable positions for your connections using 0.75mm cable stripped to 0.6mm.
4. Depress the larger slot above the cable entrance on the right hand side with a small electrical screwdriver. This allows the cable to be inserted into the slot directly below.



**WARNING:** Note that the contacts supplied are voltage free. A voltage of 120VAC or 1 to 28VDC can be connected at the contacts. The maximum load must not exceed 2A.

In a normal condition (i.e. no alarm) with the default menu settings, the relay **CLOSES** the contact for the remote alarm facility. In an alarm condition the relay **OPENS** the contact for the remote alarm facility. In the case where the facility needs the contacts to close for an alarm condition, refer to Section 8.6 for reversing the relay operation.



**WARNING:** For Alarm Remote Terminals any wiring connected to these terminals shall be protected from mains voltage by reinforced or double insulation.



## 11 Access Port

All GP freezers are provided with Access port that is located at the rear of the unit.



**IMPORTANT NOTE** These units are intended for General Purpose Cold storage. In case critical samples are stored, we recommend the use of a independent temperature monitoring system which continuously monitors freezer performance.



Internal View



Rear View

**Note** *The manufacturer recommends keeping the access port cap and plug in place when the access port is not in use.*









## 12 Maintenance & Service Of Your GP Series Freezer

### 12.1 Defrosting



**CAUTION:** When defrosting your freezer, never use sharp or heavy tools such as chisels or scrapers. Damage to the equipment can result. Let the ice melt enough so that it can be easily removed.

Alternatively, a non-scheduled defrost can sometimes be carried out as follows:

Function	Press	Hold button(s) down for	Example screen
To carry out a non-scheduled defrost		3 seconds	
followed by		Four times	
followed by		1 second	
followed by		1 second	
<i>N.B. This does not replace the automatic defrost function on relevant models.</i>			

## 12.2 Cleaning

- Your freezer should be cleaned regularly.
- Before cleaning you **MUST** switch off and disconnect your freezer from the power supply.
- The whole freezer except the door gasket can be cleaned with mild cleaning detergent.
- The door gasket should be cleaned with water only and wiped dry.
- The handle should be cleaned regularly with soap and water.
- Remove shelves and wipe with a soft cloth. **DO NOT** put them in a dishwasher.
- Detergents containing abrasives or acids are not suitable for cleaning. Do not use abrasive scouring powders, waxes, solvents, furniture polish, undiluted detergents or cleansers containing petroleum products on the surfaces of units.
- Use 2 tablespoons of baking soda in 1 quart of warm water. Be sure to wring excess water out of sponge or cloth before cleaning around controls, light bulb or any electrical parts.
- When all cleaning has been completed and accessories replaced, reconnect the plug with dry hands.

## 12.3 Storage

If the freezer is to remain unused for a period of time (e.g. during refurbishment work) switch the equipment off by pressing the power button and disconnect the power supply to the cabinet at the wall socket. It is also advised that the equipment is unplugged from the power supply. Empty, defrost and clean the freezer. Make sure the door is left slightly ajar to prevent any bad odors forming within the cabinet.

## 13 Electrical Connection

The equipment is intended for connection to alternating current. The connection values for voltage (V) and frequency (Hz) are declared on the name plate in the cabinet. Power must be connected via a wall socket with a switch. It is strongly recommended that the wall socket is easily accessible. All earthing requirements are stipulated by the Local Electricity Authority. The cabinet plug and wall socket should give correct earthing. If in doubt, contact your local supplier or an authorized electrician.



**WARNING:** THIS EQUIPMENT MUST BE EARTHED.

The flexible cord (mains lead) fitted to this equipment has three cores for use with a 3-pin moulded plug. The cores in the mains lead are colored in accordance with the following code:

GREEN: EARTH

WHITE: NEUTRAL

BLACK: LIVE

These colors might not correspond with the color markings identifying the terminals in your plug.

### Note

*First Connection to the mains:*

- *The equipment provides information about the higher temperature (Hi alarm) until the moment of cooling.*
- *The alarm feature contains “Hi” caption on the display. To cancel the alarm, press any button.*
- *Until the moment of cooling, the alarm is repeated every 15 minutes. Such an operating mode is normal until the required temperature settings are reached.*
- *The power cord serves as the main disconnecting device.*

# 14 Troubleshooting

<b>Problem</b>	<b>Reason</b>	<b>Solution</b>
The equipment does not work.	A gap in the electric system circuit.	<ol style="list-style-type: none"> <li>1. Make sure the plug is properly inserted into the socket.</li> <li>2. Make sure the socket is not faulty.</li> <li>3. Make sure the power supply cord is not damaged.</li> </ol>
	The compressor hardly ever activates.	Check to see if the ambient temperature is below +10°C (50°F).
The temperature inside the equipment is not low enough (the compressor operates continuously).	The door doesn't shut tight or is opened too often.	<ol style="list-style-type: none"> <li>1. Rearrange the products so they don't hamper the door.</li> <li>2. Shorten the time the door is open for.</li> </ol>
	The ambient temperature is above that which has been outlined in the product specification.	Check that the equipment is operating at an ambient temperature that meets the product specification.
	Air circulation at the back of the equipment is hampered.	Move equipment further away from the wall.
	The equipment is placed such that it is subject to constant sunlight, or another heat source e.g. Radiator.	Move the equipment to a different place away from heat sources or direct sunlight.
Water collects at the bottom part of the freezer.	The contents touch the back wall of the cabinet.	Move the products so they are not in contact with the back wall.
The equipment makes too much noise.	The equipment is not level.	Place the equipment on an even surface or use adjustable feet.
	The equipment is touching another object.	Reposition the equipment so it is detached from any other objects.

# Two Years Limited Warranty

This Thermo Scientific product is warranted to be free of defects in materials and workmanship for two (2) years from the first to occur of (i) the date the product is sold by the manufacturer or (ii) the date the product is purchased by the original retail customer (the "Commencement Date"). Except as expressly stated above, the MANUFACTURER MAKES NO OTHER WARRANTY, EXPRESSED OR IMPLIED, WITH RESPECT TO THE PRODUCTS AND EXPRESSLY DISCLAIMS ANY AND ALL WARRANTIES, INCLUDING BUT NOT LIMITED TO, WARRANTIES OF DESIGN, MERCHANT ABILITY AND FITNESS FOR A PARTICULAR PURPOSE.

An authorized representative of the manufacturer must perform all warranty inspections. In the event of a defect covered by the warranty, we shall, as our sole obligation and exclusive remedy, provide free replacement parts to remedy the defective product. In addition, for products sold within the continental United States or Canada, the manufacturer shall provide free labor to repair the products with the replacement parts, but only for a period of ninety (90) days from the Commencement Date

The warranty provided hereunder shall be null and void and without further force or effect if there is any (i) repair made to the product by a party other than the manufacturer or its duly authorized service representative, (ii) misuse (including use inconsistent with written operating instructions for the product), mishandling, contamination, overheating, modification or alteration of the product by any customer or third party or (iii) use of replacement parts that are obtained from a party who is not an authorized dealer of Thermo Scientific products.

Heating elements, because of their susceptibility to overheating and contamination, must be returned to the factory and if, upon inspection, it is concluded that failure is due to factors other than excessive high temperature or contamination, the manufacturer will provide warranty replacement. As a condition to the return of any product, or any constituent part thereof, to the factory, it shall be sent prepaid and a prior written authorization from the manufacturer assigning a Return Materials Number to the product or part shall be obtained.

IN NO EVENT SHALL THE MANUFACTURER BE LIABLE TO ANY PARTY FOR ANY DIRECT, INDIRECT, SPECIAL, INCIDENTAL, OR CONSEQUENTIAL DAMAGES, OR FOR ANY DAMAGES RESULTING FROM LOSS OF USE OR PROFITS, ANTICIPATED OR OTHERWISE, ARISING OUT OF OR IN CONNECTION WITH THE SALE, USE OR PERFORMANCE OF ANY PRODUCTS, WHETHER SUCH CLAIM IS BASED ON CONTRACT, TORT (INCLUDING NEGLIGENCE), ANY THEORY OF STRICT LIABILITY OR REGULATORY ACTION.

E-mail: [technicalsupport.led@thermofisher.com](mailto:technicalsupport.led@thermofisher.com)

Web: [www.thermofisher.com](http://www.thermofisher.com)

Contact Number: 1-800-438-4851

## WEEE Compliance

**WEEE Compliance.** This product is required to comply with the European Union's Waste Electrical & Electronic Equipment (WEEE) Directive 2012/19/EC. It is marked with the following symbol. Thermo Fisher Scientific has contracted with one or more recycling/disposal companies in each EU Member State, and this product should be disposed of or recycled through them. Further information on our compliance with these Directives, the recyclers in your country, and information on Thermo Scientific products which may assist the detection of substances subject to the RoHS Directive are available at [www.thermo.com/](http://www.thermo.com/)

### Great Britain



**WEEE Konformität.** Dieses Produkt muss die EU Waste Electrical & Electronic Equipment (WEEE) Richtlinie 2012/19/EC erfüllen. Das Produkt ist durch folgendes Symbol gekennzeichnet. Thermo Fisher Scientific hat Vereinbarungen getroffen mit Verwertungs-/Entsorgungsanlagen in allen EU-Mitgliederstaaten und dieses Produkt muss durch diese Firmen widerverwertet oder entsorgt werden. Mehr Informationen über die Einhaltung dieser Anweisungen durch Thermo Scientific, die Verwerter und Hinweise die Ihnen nützlich sein können, die Thermo Fisher Scientific Produkte zu identifizieren, die unter diese RoHS-Anweisung fallen, finden Sie unter [www.thermo.com/](http://www.thermo.com/)

### Deutschland



**Conformità WEEE.** Questo prodotto deve rispondere alla direttiva dell'Unione Europea 2012/19/EC in merito ai Rifiuti degli Apparecchi Elettrici ed Elettronici (WEEE).

È marcato col seguente simbolo. Thermo Fisher Scientific ha stipulato contratti con una o diverse società di riciclaggio/smaltimento in ognuno degli Stati Membri Europei. Questo prodotto verrà smaltito o riciclato tramite queste medesime. Ulteriori informazioni sulla conformità di Thermo Fisher Scientific con queste Direttive, l'elenco delle ditte di riciclaggio nel Vostro paese e informazioni sui prodotti Thermo Scientific che possono essere utili alla rilevazione di sostanze soggette alla Direttiva RoHS sono disponibili sul sito [www.thermo.com/](http://www.thermo.com/)

### Italia

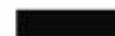

**Conformité weee.** Ce produit doit être conforme à la directive euro-péenne (2012/19/EC) des Déchets d'Equipements Electriques et Electroniques (DEEE). Il est marqué par le symbole suivant. Thermo Fisher Scientific s'est associé avec une ou plusieurs compagnies de recyclage dans chaque état membre de l'union européenne et ce produit devrait être collecté ou recyclé par celles-ci. Davantage d'informations sur la conformité de Thermo Fisher Scientific à ces directives, les recycleurs dans votre pays et les informations sur les produits Thermo Fisher Scientific qui peuvent aider la détection des substances sujettes à la directive RoHS sont disponibles sur [www.thermo.com/](http://www.thermo.com/)

### France



## Important

For your future reference and when contacting the factory, please have the following information readily available:

Model Number: \_\_\_\_\_

Serial Number: \_\_\_\_\_

Date Purchased: \_\_\_\_\_

The above information can be found on the dataplate attached to the equipment. If available, please provide the date purchased, the source of purchase (manufacturer or specific agent/rep organization), and purchase order number.

---

### IF YOU NEED ASSISTANCE:

Thermo Scientific products are backed by a global technical support team ready to support your applications. We also offer cold storage accessories, including remote alarms, temperature recorders and validation services. Visit [www.thermoscientific.com](http://www.thermoscientific.com) or call:

#### USA/Canada

Sales: +1 866 984 3766

#### India toll free

Sales: 1800 22 8374

#### India

Sales: +91 22 6716 2200

#### China

Sales: +800 810 5118 (or)  
+400 650 5118

#### Japan

Sales: +81-120-753-670

#### Australia

Sales: +61 39757 4300

#### Austria

Sales: +43 1 801 40 0

#### Belgium

Sales: +32 53 73 42 41

#### France

Sales: +33 2 2803 2180

#### New Zealand

Sales: +64 9 980 6700

#### Germany international

Sales: +49 6184 90 6000

#### Germany national toll free

Sales: 0800 1 536 376

#### Italy

Sales: +32 02 95059 552

#### Netherlands

Sales: +31 76 579 55 55

#### Nordic/Baltic/CIS countries

Sales: +358 9 329 10200

#### Russia

Sales: +7 812 703 42 15

#### Spain/Portugal

Sales: +34 93 223 09 18

#### Switzerland

Sales: +41 44 454 12 22

#### UK/Ireland

Sales: +44 870 609 9203

#### Other Asian countries

Sales: +852 2885 4613

#### Countries not listed

Sales: +49 6184 90 6000



Thermo Fisher Scientific Inc.

275 Aiken Road  
Asheville, NC 28804  
United States  
[www.thermofisher.com](http://www.thermofisher.com)

**thermo**scientific

**327905H01 Rev. B**