

Horizontal Systems

Models B1A, B1, B2 and B3

Operating and Maintenance Manual 7007309 Rev. 0



Visit us online to register your warranty
www.thermoscientific.com/warranty



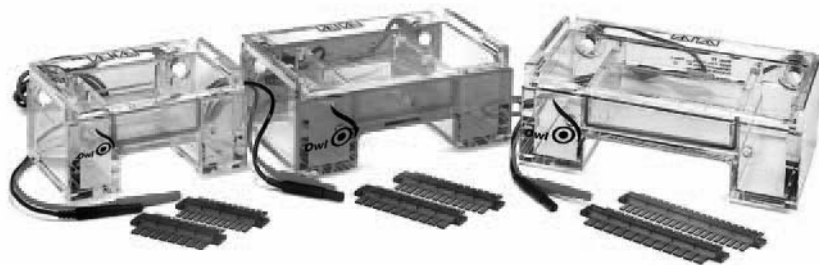

Model B1A, B1 and B2



Model B3

MANUAL NUMBER 7007309

0	--	4/16/12	Transfer to Marietta (was 2/2004)	CCS
REV	ECR/ECN	DATE	DESCRIPTION	By



Important Read this instruction manual. Failure to read, understand and follow the instructions in this manual may result in damage to the unit, injury to operating personnel, and poor equipment performance. ▲

Caution All internal adjustments and maintenance must be performed by qualified service personnel. ▲

Warning To avoid the risk of personal shock, always disconnect the gel box from the power supply. Further, the power supply must be equipped with a shut-down-on-disconnect circuit. Do not move the unit unless the power source to the unit has been disconnected. ▲

Statement of Proper Use: Use this product only for its intended purpose as described in this manual. Do not use this product if the power leads are damaged or if any of its surfaces are cracked.

Caution Running conditions for this unit should not exceed the name plate readings found on the lower buffer chamber. ▲

This Owl System is designed to meet IEC 1010-1 safety standards (IEC 1010-1 is an internationally accepted electrical safety standard for laboratory instruments).

Material in this manual is for information purposes only. The contents and the product it describes are subject to change without notice. Thermo Scientific makes no representations or warranties with respect to this manual. In no event shall Thermo be held liable for any damages, direct or incidental, arising out of or related to the use of this manual.

©2012 Thermo Scientific. All rights reserved.



Important operating and/or maintenance instructions. Read the accompanying text carefully.



Potential electrical hazards. Only qualified persons should perform procedures associated with this symbol.



Equipment being maintained or serviced must be turned off and locked off to prevent possible injury.



Hot surface(s) present which may cause burns to unprotected skin, or to materials which may be damaged by elevated temperatures.



Marking of electrical and electronic equipment, which applies to electrical and electronic equipment falling under the Directive 2002/96/EC (WEEE) and the equipment that has been put on the market after 13 August 2005.



This product is required to comply with the European Union's Waste Electrical & Electronic Equipment (WEEE) Directive 2002/96/EC. It is marked with the WEEE symbol. Thermo Scientific has contracted with one or more recycling/disposal companies in each EU Member State European Country, and this product should be disposed of or recycled through them. Further information on Thermo's compliance with this directive, the recyclers in your country and information on Thermo Scientific products will be available at www.thermo.com.

- ✓ Always use the proper protective equipment (clothing, gloves, goggles, etc.)
- ✓ Always dissipate extreme cold or heat and wear protective clothing.
- ✓ Always follow good hygiene practices.
- ✓ Each individual is responsible for his or her own safety.

Do You Need Information or Assistance on Thermo Scientific Products?

If you do, please contact us 8:00 a.m. to 6:00 p.m. (Eastern Time) at:

1-740-373-4763

1-800-438-4851

1-877-213-8051

<http://www.thermoscientific.com>

service.led.marietta@thermofisher.com

www.unitylabservices.com

Direct

Toll Free, U.S. and Canada

FAX

Internet Worldwide Web Home Page

Tech Support Email Address

Certified Service Web Page

Our **Sales Support** staff can provide information on pricing and give you quotations. We can take your order and provide delivery information on major equipment items or make arrangements to have your local sales representative contact you. Our products are listed on the Internet and we can be contacted through our Internet home page.

Our **Service Support** staff can supply technical information about proper setup, operation or troubleshooting of your equipment. We can fill your needs for spare or replacement parts or provide you with on-site service. We can also provide you with a quotation on our Extended Warranty for your Thermo Scientific products.

Whatever Thermo Scientific products you need or use, we will be happy to discuss your applications. If you are experiencing technical problems, working together, we will help you locate the problem and, chances are, correct it yourself...over the telephone without a service call.

When more extensive service is necessary, we will assist you with direct factory trained technicians or a qualified service organization for on-the-spot repair. If your service need is covered by the warranty, we will arrange for the unit to be repaired at our expense and to your satisfaction.

Regardless of your needs, our professional telephone technicians are available to assist you Monday through Friday from 8:00 a.m. to 6:00 p.m. Eastern Time. Please contact us by telephone or fax. If you wish to write, our mailing address is:

Thermo Fisher Scientific
401 Millcreek Road, Box 649
Marietta, OH 45750

International customers, please contact your local Thermo Scientific distributor.

Table of Contents

Section 1	General Information	1-1
	Introduction	1-1
	Unpack and Check	1-2
Section 2	Setting Up	2-1
	Preparing the Gel	2-2
	Migration Distance	2-3
Section 3	Using the System	3-1
	Specifications and Recommended Running Conditions	3-2
Section 4	Finishing Up	4-1
Section 5	Technical Tips	5-1
Section 6	Troubleshooting	6-1
Section 7	Care and Cleaning	7-1
Section 8	Optional Equipment	8-1

Section 1 General Information

Introduction

Horizontal Minigel Systems - Models B1A, B1, and B2

The Horizontal Minigel Systems, are designed to provide flat, even banding patterns and consistent results with hassle-free gel casting. The all-in-one design allows you to cast and run gels in the same chamber, eliminating the need for additional casting equipment. No tape, grease, agarose seals or other accessories are required. All systems accommodate 2 comb positions, allowing the user to run 2 series of samples equal distances simultaneously. Convenient visualization strips have been added for easier sample loading; and fluorescent ruled UVT gel tray helps in the precise photodocumentation of each gel run. Three gel sizes are available for increased sample capacity and running length. Stand-alone casting platforms are available for pouring up to 3 gels simultaneously while the chamber is in use. Owl offers a wide variety of combs, including options that can double your sample capacity by doubling the number of sample wells, preparative combs, and wall combs to run gels in smaller sizes. Custom combs are also available.

Self Recirculation System - Model B3

This system has a unique built-in recirculation system that offers convenience and versatility. The recirculation system prevents formation of pH and ionic gradients for high resolution and uniform reproducible results. Ideal for long runs, multiple sample sets or RNA gels - this system delivers clear results for samples run over long time periods. It also eliminates uneven migration, band distortion or disassociation of pH dependent glyoxylated RNA molecules that can result when ionic depletion occurs.

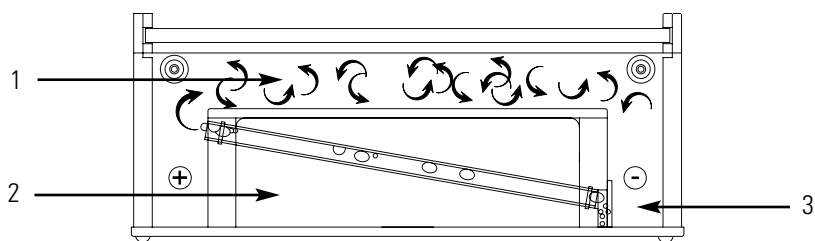

Figure 1-1. Self-Circulation System

Self Recirculation System - Model B3 (continued)

The self recirculating system reduces formation of pH gradients so you get high resolution and uniform, reproducible results. The self-contained recirculation system requires no external pumps, tubing or stir bars. As shown in the diagram, a trap at the cathode end of the buffer chamber (1) collects the hydrogen bubbles produced at the electrode during electrophoresis. The bubbles are then shunted into a conduit tube (2) to the anode end of the chamber. This flow of bubbles displaces buffer (3) to create an effective recirculation within the chamber.

Unpack & Check Your Order

Before starting, unpack the unit and inventory your order. If any parts are missing, contact Technical Services within 7 days of purchase.

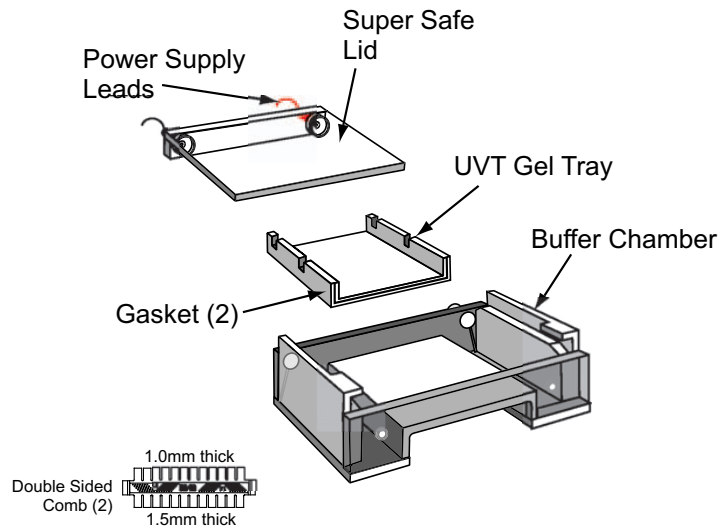

Figure 1-2. Exploded Parts Diagram

B1A, B1 & B2 Parts List

- Buffer Chamber
- Combs: (2) 1.0/1.5mm thick, double sided
- Super Safe™ Lid with attached Power Supply leads (2)
- Gasketed UV Transmissible (UVT) Gel Tray

Specifications and Recommended Running Conditions

Model	B1A	B1	B2
Gel Size (W x L cm)	7x8	9x11	12x14
Buffer Capacity	400ML	600ML	800ML
Time Requirements (minutes)	30-60	45-90	60-120
Voltage Requirements (V)	20-150	20-150	20-150

Section 2 Setting Up

1. Remove the SuperSafe™ lid from the buffer chamber. The SuperSafe™ Lid is attached to the back of the unit at the junction of the lid's attached power supply leads to the banana plugs located on the unit. To remove hold the front of the buffer chamber with one hand and pull the lid off; sliding it off evenly by holding the center of the back of the lid.
2. For shipping and convenient storage, the gel trays are packaged inside the casting chamber. To remove the gel trays, hold the casting chamber firmly with one hand; grasp the long sides of the UVT gel tray and pull up slowly at an angle with your other hand. The trays fit snugly for leak proof gel casting; therefore they may be tight. "Walking" the tray upwards at an angle may be helpful. The tightness will diminish, the more the unit is used.

Additional Step for Model B3

Priming the Unit

Fill the B3 chamber with enough buffer to fill both compartments, and allow it to stand for about 15 minutes prior to running. Fill the chamber at the cathode end (black electrode) first. This will flush out trapped air in the hydrogen collector and recirculation tube.

Priming the unit is most important when using buffers of low ionic strength (like TAE or NaPO₄). This process minimizes the electrostatic repulsion between the hydrogen gas bubbles and the recirculation tube's surface. Neglecting this step may result in decreased efficiency of the recirculation system. Refer to normal Setting Up instructions for use following this priming step.

3. To cast gels, place the UVT gel tray into the buffer chamber in the casting position (Figure 3-1), making sure the gel tray rests level and centered on the platform. Be sure the gasketed ends of the gel tray press against the walls of the buffer chamber. Thermo offers a leveling platform, Catalog No. B-LP, Section 8, if needed.

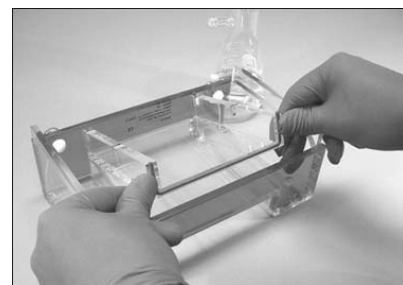

Figure 2-1. UVT Gel Tray

4. **Preparing the Gel** - Using electrophoresis-grade agarose and compatible electrophoresis buffer, the gel may be prepared in various ways. The percentage of agarose and the electrophoretic buffer used is determined by the size of the samples to be separated and further recovery of the samples (see Table 5-1, page 16). The agarose and buffer are mixed and heated

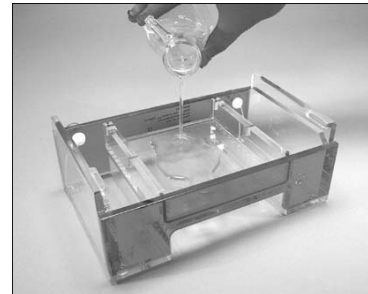

Figure 2-2. Pouring Gel

- over a heat source, in a microwave oven, or in an autoclave until the agarose is completely dissolved. The prepared gel then must be cooled to below 60°C before casting to avoid warping the UVT gel tray, due to excessive heat. If numerous gels are to be run in one day, a large volume of gel may be prepared and placed in a covered bottle stored between 40-60°C in a water bath. This provides a ready gel supply in a warm liquid form that will solidify quickly when gels are cast. For further tips on sample preparation and visualization (see Section 5).
5. Pour or pipette the correct amount (see page 5-8) of warm agarose (<60°C) onto the UVT gel tray that has been placed in the casting position in the buffer chamber. Immediately after pouring, insert the desired comb or combs into the comb slots to form the sample wells. If only a small portion of gel is required for proper sample separation, multiple combs may be used to run 2 sets of equal distance samples simultaneously expanding the number of samples per gel that may be run. Multiple sample loading configured for use with an 8 channel pipette is available by using the multi load tray (see Section 8).

To conserve agarose, a wall comb may also be used to divide and use a smaller portion of the length of the gel tray. If a wall comb is used, pipette a bead of agarose along the bottom and side edges of the wall comb once it has been placed in the tray to seal the combs edges to the trays bottom and sides. Once this bead is solidified, the cooled gel may be poured as described. Alternately, regular tape cut slightly longer than the comb can be placed flat along the combs surface and the comb angled into place in the gel tray. Extra tape is then placed on the outside of the comb in the excess tray area to reinforce the corners. Allow the gel to solidify completely.

Migration Distance

- Run one sample set on a gel in each tray
- Run two sample sets on a gel of equal length (comb slots) in each tray
- Run three sample sets on a gel of equal length samples (comb slots) in each tray
- Run four sample sets on a gel of equal length samples (comb slots) in each tray and so on, up to 12 rows

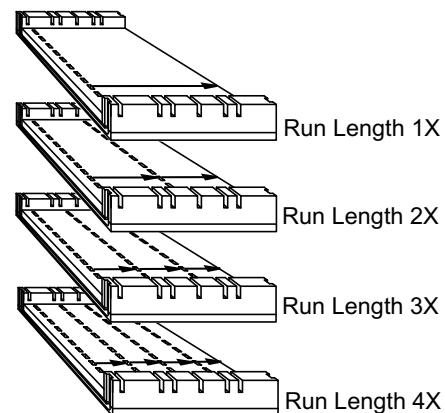

Figure 2-3. Run Lengths

Specific Tray Options for Each Model

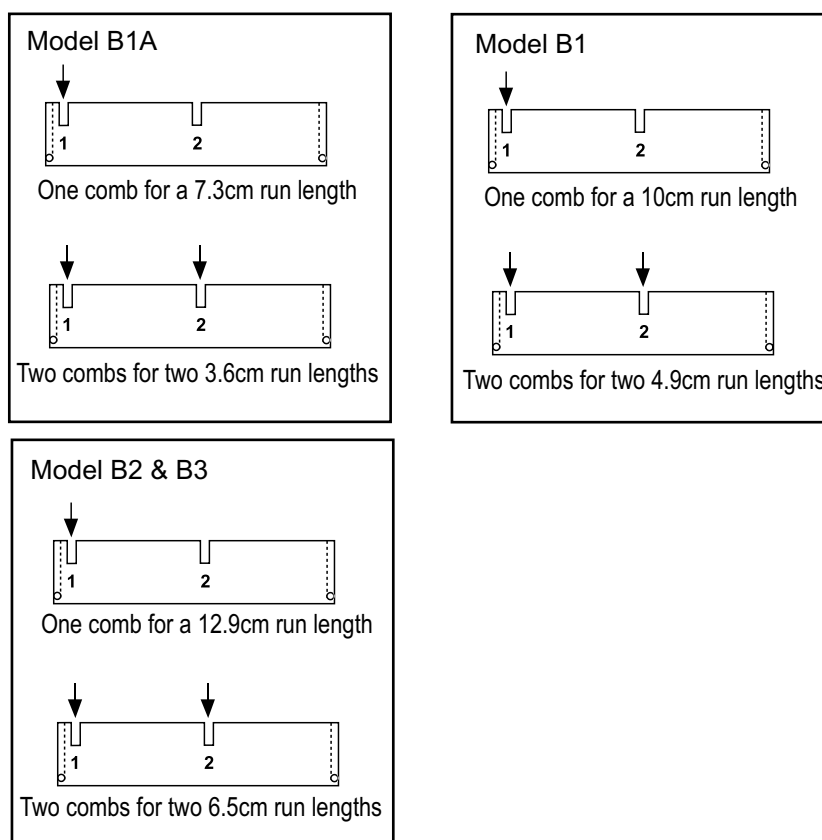

Figure 2-4. Tray options

Section 3 Using the System

1. Once the gel is completely solidified, lift the tray out of the chamber, turn it 90° in the running position (see Figure 3-1), and replace it in the chamber with the first comb closest to the cathode side of the chamber. This running position exposes the open ends of the agarose to the buffer. Standard agarose should solidify completely in about 30 minutes. If low melting point or a speciality agarose is used, consult the instructions that came with the product.
2. Pour enough compatible running buffer into the unit to fill the buffer chamber and completely cover and submerge the gel. Correct buffer level is clearly marked on the units side wall as “FILL LINE”. See Recommended Running Conditions for approximate buffer volumes needed for your unit. Too little buffer may cause the gel to dry out during the run, while excess buffer may decrease DNA mobility and cause band distortion.
3. Carefully remove the comb (or combs) by tapping lightly to loosen, and slowly lifting straight up out of the gel tray to avoid damage to the wells.
4. **Loading the Sample in Gel:**

Wet loading - loading the sample in the gel when it is submerged in buffer.

- a. Place the gel tray into the buffer chamber in the running position.
- b. Pour running buffer into the unit to fill chamber and completely cover and submerge the gel.
- c. Load prepared samples into the wells. Samples should be mixed with a sample loading buffer; giving weight to the samples so that they drop evenly into the wells, and contain tracking dye to monitor the gel run.

Note Load prepared samples into the wells. Samples should be mixed with a sample loading buffer; giving weight to the samples so that they drop evenly into the wells and containing tracking dyes to monitor the gel run. See available comb section for approximate well volumes (Comb Options, Section 5). ▲

Note It is wise to always run a sample lane of a known “standard ladder” to determine concentration and size of separated fragments after the gel run, and to aid in photo documentation and analysis (see Section 5). ▲

Casting Position

Running Position

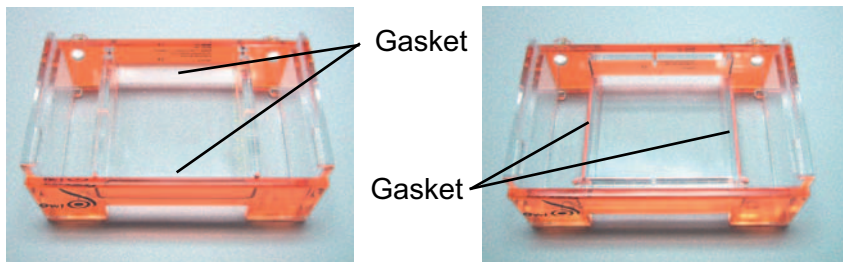

Figure 3-1. Tray Positions

5. Carefully slide the SuperSafe™ lid with attached power supply leads onto the unit. This will connect the power cords to the banana plug electrodes. Plug the other end of the power supply leads into an appropriate power supply, completing the circuit. The gel is now a resistor in the circuit.
6. Turn on power supply. Refer to table below for running conditions. Carefully monitor the gel run to avoid samples running into the path of another set of samples.

Specifications and Recommended Running Conditions

Model	B1A	B1	B2	B3
Gel Size (W x L in cm.)	7x8	9x11	12x14	12x14
Buffer Capacity	400ml	600ml	800ml	1000ml
Voltage Requirements (V)	20-150	20-150	20-150	20-150
Time Requirements (minutes)	30-60	45-90	60-120	60-120

Section 4 Finishing Up

1. When the gel run is complete and tracking dye has migrated as far through the gel as desired, or to the end of the gel, turn off the power supply and slide off the SuperSafe™ lid to disconnect from the power source. Carefully remove the tray containing the gel (wear gloves if ethidium bromide is present). The UV Transmissible (UVT) gel tray makes visualization and photography with a UV light source easy without the need to remove the gel from the tray.
2. The buffer chamber, SuperSafe™ lid, UVT gel tray and combs should be rinsed under warm running water after each use. An RNase/DNase decontaminate may be used. This electrophoresis system must never be autoclaved, baked, or microwaved!

Note Rather than staining with Ethidium Bromide, other stains are now available, which are less hazardous. These include SYBR Green, SYBR Gold, and SYBR Safe. While their excitation maxima are in the visible region, there is a fair amount of excitation in the UV region, so your current UV transilluminator will work with them.

Besides safety, another advantage to using a light source with a frequency in the visible light region is that the transmission diffuser, normally a quartz window on UV lights, can be made of far less expensive materials, and therefore made much larger. Clare Chemical Research (<http://www.clarechemical.com/transilluminator.htm>) makes several of these “blue light” transilluminator under the name of Dark Reader. ▲

Dark Reader Model	Viewing Surface	Compatible Owl Units
DR45M	14 x 21 cm	All but A6, A3-1 and D3
DR88M	21 x 25 cm	All but A6 and A3-1
DR195M	30 x 46 cm	A3-1

Section 5 Technical Tips

Running A Standard Ladder

It is recommended to always run a sample lane of a known “standard ladder” or “marker” to determine concentration and size of separated fragments after the gel run, and to aid in photodocumentation and analysis.

Migration patterns and fragment sizes for commonly used DNA molecular weight markers are shown in this figure.

Loading Samples

It is sometimes easier to load the sample wells dry before placing buffer into the buffer chamber. After the gel solidifies, if cast within the buffer chamber, remove the gel tray from the buffer chamber and place the tray on the lab bench. Carefully remove the sample combs by tapping and lifting straight up. Samples mixed with loading buffer that does not contain dye may be easier to load dry, especially in larger gel units to avoid cross-contamination. After loading all sample lanes, place the gel tray into the buffer chamber in the running position with the gel edges facing out toward the buffer chambers with the gasketed end gates removed and slowly fill the chamber with buffer.

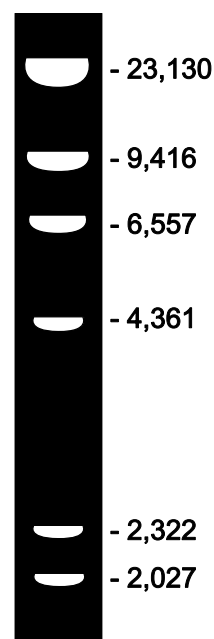

Figure 5-1. Ladder

Comb Options

Standard

1.0mm and 1.5mm thickness for all models. Combs are hand fabricated for high quality precision in low volumes. Each comb has an acrylic spine with Lexan® teeth.

Double Sided

Double sided molded combs combine 1.0mm and 1.5mm tooth thickness on one comb. These combs provide greater precision due to the exact manufacturing technique which provides greater control over tooth size and spacing than the traditional machining methods. The number of teeth and arrows that point to the designated thickness is molded onto the spine for easy identification. A raised section of the spine helps the user grip the comb when removing it from the gel. Thermo's combs are molded from durable polycarbonate that holds up through years of use.

Preparative

Preparative combs are manufactured with an acrylic spine and Lexan® teeth. Used for extremely large samples.

Multi Load Comb

For use with 8-12 channel pipettes. These unique combs are designed to allow accurate easy loading from a 96 well plate.

Custom Combs

Call Technical Services for more information.

Wall Comb

The wall comb is used in your existing U.V. Transmissible (UVT) gel tray to allow the ability to cast smaller gels using the existing gel tray and the comb slots. There are various ways to use the wall comb to ensure a leak proof seal. These two are the fastest and easiest.

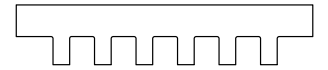

Standard

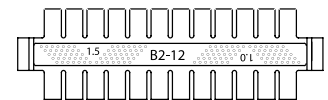

Double Sided

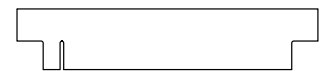

Preparative

Figure 5-2. Combs

Comb Options (continued)

Tape Method

Using casting tape, transparent tape, or masking tape, cut a piece long enough to cover the full length of the wall comb with about 1/2" overhang at each end. Half the width of the tape should be free. Firmly press the tape all along the comb leaving the three open edges loose. Place the "taped" comb into the gel tray at the desired comb slot position. The taped side should be facing away from where the gel will be cast. While placing the comb, angle it so the loose taped edge is free. Once positioned into the gel tray, firmly press the tape to the bottom and sides of the gel tray to form a leakproof seal. Small pieces of tape may be added to the corners afterwards to reinforce the edges. Add cooled (<math><60^\circ</math>), slightly thickened agarose to the gel tray and allow to solidify completely. To remove comb, gently remove excess tape and loosen tape from the bottom and sides of the gel tray. Carefully pull comb straight up and out of the comb slot.

Note The edge of the gel may appear irregular; once submerged in running buffer, the gel run will be unaffected. ▲

There are four options that fit the use of a 9mm "center to center" pipette tip format. The 9mm spacing represents a 1x option micro well format. By decreasing the center to center distance in factors of 9mm, one can fit more samples in a given amount of space with the ability to use the same micro well format pipette. The 2x is 9 divided by 2, the 3x is 9 divided by 3 and the 4x is 9 divided by 4.

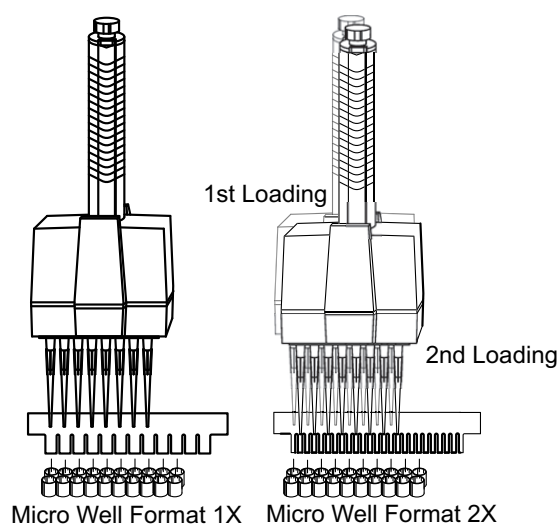

Figure 5-3. Loading Options

Therefore, it is possible to have a greater number of teeth in a comb and maintain the use of the multichannel pipette, by having the multichannel pipette fill every other well rather than every well. This type of multichannel pipette format comb is called a 2x multichannel pipette format comb. For example, the 50 tooth comb for the A6 device has "center to center" distances between teeth of 4.5cm. This means that a researcher would load lanes 1, 3, 5, 7, 9, 11, 13, and 15 with the first pass of the pipette and 2, 4, 6, 8, 10, 12, 14 and 16 with the second pass, and so on until all of the lanes are filled.

When using an 8 (or 12) channel pipette, the number of sample wells that can be filled must be a multiple of 8 (or 12). A 25 well micro well format comb would have one extra sample and a 50 well micro well format comb would have 2 extra samples, which a researcher could fill with a single channel pipette, and is generally used for standards.

Why Recirculate Buffer?

During electrophoresis, gradual ionic depletion of the running buffer forms an ionic and pH gradient across the system (acetate and phosphate buffers are especially prone to ionic depletion). Such gradients can cause uneven migration and banding patterns or cause pH-dependent glyoxylated RNA molecules to disassociate. Buffer recirculation ensures uniform ionic strength throughout the system.

Comparison of buffer pH with and without recirculation during agarose gel electrophoresis.

50ng samples of Hind III digested DNA were run on duplicate gels, with and without buffer recirculation. pH measurements were taken at the anode and cathode ends at various time intervals and

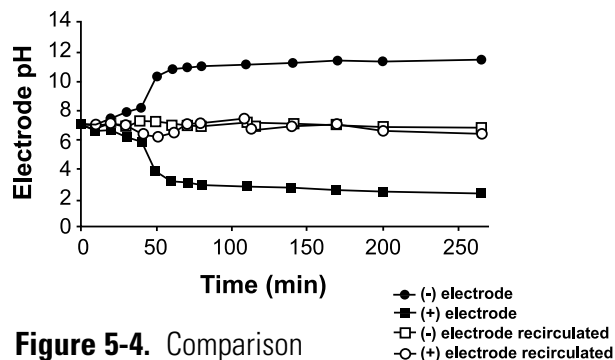

Figure 5-4. Comparison

plotted against time. Running condition: 1% agarose gel in 10mM NaH₂PO₄, pH 7.0, 114V, constant voltage.

Sample Well / Comb Configuration

Hg = height of gel used Hs = height of well used for sample volume
Hw = well height

How to determine well sample volume:

There are two volumes to consider when determining the sample volume for a horizontal gel. 1) Gel volume, which is Width x Length x Gel Height and uses centimeters and 2) Sample volume which is Tooth Width x Comb Thickness x Apparent Well Height, and uses millimeters.

How to Determine Well Sample Volume: (continued)

Gel height is generally set to a height between 0.25 cm and 1.0 cm.

Therefore, once you choose the height, the volume is the gel dimensions given in the catalog for each gel box (I.D.) times this height. Once the gel height (H_g) is chosen, the well volume and then the sample volume can be calculated. The well height (H_w) is 1.5 mm less than the gel height: $H_w = \text{Gel Height} - 1.5\text{mm}$. Using the well height, the volume of the well is calculated: $V_w = (\text{Well Height}) (\text{Tooth width} \times \text{comb thickness})$. The loading volume is a 0.75 safety factor applied to the well volume: $V_s = (V_w) (.75)$

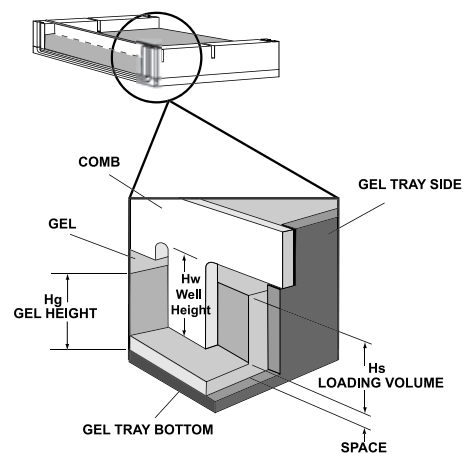

Figure 5-5. Determine Volume

For Owl combs, there are two thicknesses, 1.0mm and 1.5mm. This is the depth. The width of the well is determined by the number of teeth. For a given gel box, as the number of teeth increase, the volume of each tooth decreases.

Reagent Information

There are various types of agarose commercially available that may be used. Besides standard ultra pure electrophoresis grade agarose, there are also numerous low melting point products for easy sample recovery, as well as speciality products formulated for specific uses to separate/recover very small or very large fragments etc.

To visualize and photograph the samples after the gel run for a permanent record, the gel may be stained during or following the run with a variety of stains. The most common stain for DNA is ethidium bromide. Ethidium bromide may be added directly to the gel and running buffer to quickly and easily visualize and photograph the separated fragments following the gel run without the need for additional staining. If this is not added, then following the gel run, the gel may also be soaked in a concentrated ethidium bromide solution and rinsed for the same visualization. The ethidium bromide is added to both the gel (after heating) and the electrophoresis buffer at a concentration of 0.5 $\mu\text{g}/\text{ml}$.

Warning Ethidium bromide is a potential carcinogen. Care in handling the powder and stock solution must be taken. Always wear gloves when handling the powder, solutions and all gels that contain any amount of ethidium bromide. ▲

Mobility range of DNA in different percentage agarose gels

<u>Agarose % (w/v)</u>	<u>Approximate range of separated DNA fragments (kb)</u>
0.3	.60 to 5
0.5	.30 to 1
0.7	.12 to 0.8
1.0	.10 to 0.5
1.2	.7 to 0.3
1.5	.4 to 0.2
2.0	.3 to 0.1
3.0	<0.1

It should be noted, an increased agarose % gives better separation of small fragments and also bands very close together that tend to be more difficult to separate, visualize and photograph. A specialty agarose product formulated to increase resolution of low molecular mass samples may also be used.

Example: A good mid range gel percentage would be 0.7%, or 0.7g agarose in 100mls electrophoresis buffer (TBE or TAE), following heating and dissolving the agarose, 10µl of ethidium bromide stock solution (5mg/ml) is added. The gel would be run with compatible electrophoretic running buffer (1X TBE or 1X TAE) that also contained ethidium bromide 1 liter of the running buffer would contain 100µl of this 5mg/ml ethidium bromide stock solution.

Preparation & Properties of TAE and TBE Electrophoresis Buffer Systems:

These buffers are used because they both have a basic pH which gives the phosphate group of the DNA a net negative charge, allowing migration of the DNA toward the positive anode in the electrophoresis chamber.

TAE - Tris acetate with EDTA

(40mM Tris base 40mM acetic acid, 1mM EDTA)

50X stock solution, pH ~8.5 . . 1X working solution

242g Tris base 40mM Tris acetate

57.1ml glacial acetic acid 1mM EDTA

18.61g Na₂EDTA - 2H₂O (MW 372.24)

Distilled H₂O to 1 liter final volume

TBE - Tris borate with EDTA

(89mM Tris base, 89mM boric acid, 2mM EDTA)

10X stock solution: **1X working solution:**

108g Tris base 89mM Tris base

55g boric acid 89mM boric acid

7.44g Na₂EDTA - 2H₂O (MW 372.24) 2mM EDTA

(or 40 ml 0.5 M EDTA, pH 8.0)

Distilled H₂O to 1 liter final volume

Do not adjust pH

Buffer: TAE Buffer

Suggested Uses and Comments: Use when DNA is to be recovered; For electrophoresis of large (>20kb) DNA; Applications requiring high resolution; Has low ionic strength and low buffering capacity — recirculation may be necessary for long runs (> 4hrs.)

Buffer: TBE Buffer

Suggested Uses and Comments: For electrophoresis of small (<1kb) DNA; Better resolution of small (<1kb) DNA; Decreased DNA mobility; High ionic strength and high buffering capacity - no recirculation needed for extended run times

TBE buffer reacts with the agarose making smaller pores and a tighter matrix. This reduces broadening of the DNA bands for sharper resolution.

Ethidium Bromide

Ethidium bromide is ideal for the fluorometric detection of nucleic acids in gel electrophoresis. The addition of ethidium bromide to both the prepared gel and running buffer is a convenient way to monitor separation and keep a photographic log of gel runs. Ethidium Bromide is prepared as 10mg/ml in distilled water and used as a stock working solution of 5.0µg/ml in the electrophoresis buffer and gel. Mix ethidium bromide powder or tablet thoroughly into solution checking for any precipitate and store at room temperature protected from light.

Amount of Agarose to Prepare:

Gel volume is determined by the following formula and may be adjusted according to need or preference:

Amount of Agarose

gel width(cm) x gel length (cm) x gel thickness (cm) = ml of agarose

		Agarose Volume in ml per gel thickness in cm			
Model #	Gel size (cm)	0.25cm	0.5cm	0.75cm	1.0cm
B1A	7 X 8	14ml	28ml	42ml	56ml
B1	9 X 11	25ml	50ml	74ml	99ml
B2	12 X 14	42ml	84ml	126ml	168ml
B3	12X14	42ml	84ml	126ml	168ml

Agarose Gel Loading Buffer

Samples are prepared and combined with gel loading buffer before being applied to the prepared gel. Sample buffer usually contains similar components to the running buffer, dyes for visibility, and glycerol to provide some weight to the samples. This increased sample density and color allows easy visualization of the samples and ensures samples load evenly into the wells and do not float out during loading. Dyes also migrate toward the anode end of the electrophoresis chamber at predictable rates allowing the gel run to be monitored.

The most commonly used loading buffer is glycerol, bromophenol blue, and xylene cyanol.

Section 6 Troubleshooting

Problem	Solution
Bands are not sharp, clear, and even.	Always follow the proper procedure for preparing the agarose product according to the manufacturers instructions. When preparing the agarose, be sure all the agarose powder is in solution before heating. In general, add powdered agarose to distilled water and swirl to mix. Make sure all the powder is equally wet to ensure proper melting. Heat in a microwave oven, boiling water bath, or hot plate with occasional swirling to melt and mix completely. Cool agarose liquid to below 60° and cast. Note: Gel should be cast no thicker than 5mm to avoid fuzzy banding. High percentage gels may thicken and solidify rapidly and should be cast while still a liquid.
Samples are not moving as expected through the gel, remaining in the wells, or diffusing into the gel.	Check that a complete power circuit is achieved between the unit and the power supply. Platinum wire and banana plugs should be intact. To test, simply fill the unit with running buffer and attach to the power supply without a gel or gel tray in the unit. The platinum wires on both sides of the unit should produce small bubbles as the current passes through. If a complete circuit does not exist, there will be few to no bubbles. Contact Technical Services to schedule a repair.
When the comb is removed from the gel, some sample wells are ripped and damaged.	Always make sure to allow the gel to solidify completely before moving the gel tray, unit, or removing the comb. To avoid damage to the sample wells, gently rock the comb back and forth lightly to loosen, then slowly pull the comb straight up out of the gel tray. This rocking helps to avoid suction as the comb is removed. Alternatively, once casting is complete, simply submerging the gel with running buffer will help loosen the comb. Using a higher percentage of agarose that forms a tighter gel matrix may remedy this problem as well.
The gel seems to run slower under the usual running conditions.	The volume of running buffer used to submerge the gel should only be between 3-5mm over the gel surface. Gel should be completely submerged to avoid the gel from drying out, which can smear the bands and possibly melt the gel(s) due to overheating. If excessive running buffer is added, the mobility of the DNA decreases and band distortion may result. Excess buffer causes heat to build up and buffer condensation inside the unit may result.

Problem	Solution
Agarose leaks into chamber when casting the gel	Check to see if the gasket is correctly seated in groove and even all the way around. Remove gasket and reseal by smoothing out gently with your thumb from one end to the other. Gasket material may have a tendency to absorb salts from the running buffer. After each use, rinse the end gates under warm running water to bring back spongelike consistence of the gasket material. Gaskets may eventually become brittle with frequent use. Contact Technical Services to purchase replacement gaskets.
Bands seem to be running at an angle.	Check to be sure that the unit is properly leveled for casting and running the gel by using the thumbscrews on the base. Thumbscrews should be adjusted until the bubble in the level lines up with the levels center circle. Always center the gel tray holder on the platform and cool the agarose to below 60° before pouring to avoid warping the UVT gel tray (s).
Samples seem to be running unevenly in certain areas.	Check that the platinum electrode wire is intact running flat and evenly across the outer corners and up the side to the junction of the banana plug area. This problem could also be caused by regular casting with very hot agarose gel (>60°) which may damage the gel tray over time. Always cool the melted agarose to below 60o before casting to avoid warping the UVT gel tray (s). Warping the UVT gel tray will cause all subsequent gels to be cast unevenly.
Samples do not band sharply and appear diffuse in the gel.	Gels should be no more than 5mm thick and allowed to solidify completely before running. For standard agarose, this would be about 30 minutes, if low melting point agarose is used, it may be necessary to completely solidify gels at a cooler temperature in the refrigerator or cold room. Gels should be submerged in 3-5mm of buffer to avoid gel dry out, but excess buffer >5mm can cause decreased DNA mobility and band distortion.

Additional Sources For Reference

Maniatis T., E. F. Fritsch and J. Sambrook. **Molecular Cloning: A Laboratory Manual**, Cold Spring Harbor Laboratory, Cold Spring Harbor, NY.

Short Protocols in Molecular Biology, - A Compendium of Methods from Current Protocols in Molecular Biology, Edited by Fredrick M. Ausubel, et. al. Adams, D., and R. Ogden, **Electrophoresis in Agarose and Acrylamide Gels, Methods in Enzymology**, Vol. 152 (1987) Academic Press, Inc.

Fotador, U.. **Simultaneous Use of Standard and Low-Melting Agarose for the Separation and Isolation of DNA by Electrophoresis**, BioTechniques, Vol. 10, No. 2, (1991)

Boots, S. **Gel Electrophoresis of DNA**; Analytical Chemistry, Vol. 61, No. 8, April 15, 1989

Section 7 Care and Cleaning

Caution Organic solvents cause acrylic to “craze” or crack. Clean all acrylic systems with warm water and a mild detergent. do not use ethanol or other organic solvents to clean these products. Do not autoclave, bake, or microwave your unit. Temperatures over 50°C can damage the acrylic. ▲

Note If an RNase free electrophoresis system is desired, there are various methods to rid the system of RNA contamination. For fast and easy decontamination, use RNase AWAY®*. Spray, wipe or soak labware with RNase Away, then wipe or rinse the surface clean; it instantly eliminates RNase. RNase Away® eliminates the old methods that include treatment with 0.1% Diethyl Pyrocarbonate (DEPC) treated water and soaking in diluted bleach. This electrophoresis system should never be autoclaved, baked, or placed in a microwave. ▲

Warning DEPC is suspected to be a carcinogen and should be handled with care.

To order RNase AWAY, contact Technical Services:

Part Number	Description
7000250ml bottle
7002475ml spray bottle
70031 liter bottle
70054 liter bottle

**Rnase AWAY® is a registered trademark of Molecular BioProducts*

Section 7

Care and Cleaning

Care Of Acrylic

This list does not include all possible chemical incompatibilities and safe compounds. Thermo's acrylic products should be cleaned with warm water, a mild detergent such as Alconox™, and can also be exposed to a mild bleach solution (10:1). In addition, RNAse removal products are also safe for acrylic. Contact Technical Services with any questions.

The following chemical compatibility chart is supplied for the convenience of our customers.

Although acrylic is compatible with most solvents and solutions found in the biochemical laboratory, some solvents can cause substantial damage. Keep this chart handy to avoid harm to your apparatus by the use of an inappropriate solvent.

Codes:

S - Safe (No effect, except possibly some staining)

A - Attacked (slight attack by, or absorption of, the liquid)
(slight crazing or swelling, but acrylic has retained most of its strength)

U - Unsatisfactory (softened, swollen, slowly dissolved)

D - Dissolved (in seven days, or less)

Table 7-1. Chemical Compatibility for Acrylic-Based Products

Chemical	Code	Chemical	Code	Chemical	Code
Acetic acid (5%)	S	Ethyl alcohol (50%)	A	Naptha	S
Acetic acid (Glacial)	D	Ethyl alcohol (95%)	U	Nitric acid (10%)	S
Acetic Anhydride	A	Ethylene dichloride	D	Nitric acid (40%)	A
Acetone	D	Ethylene glycol	S	Nitric acid concentrate	U
Ammonia	S	2-Ethylhexyl Sebacate	S	Oleic acid	S
Ammonium Chloride (saturated)	S	Formaldehyde (40%)	S	Olive oil	S
Ammonium Hydroxide (10%)	S	Gasoline, regular, leaded	S	Phenol 5% solution	U
Hydroxide (10%)	S	Glycerine Heptane (commercial grade)	S	Soap solution (Ivory)	S
Ammonium Hydroxide concentrate	S	Hexane	S	Sodium carbonate (2%)	S
Aniline	D	Hydrochloric acid (10%)	S	Sodium carbonate (20%)	S
Benzene	D	Hydrochloric acid concentrate	S	Sodium chloride (10%)	S
Butyl Acetate	D	Hydro uoric acid (40%)	U	Sodium hydroxide (1%)	S
Calcium chloride (saturated)	S	Hydrogen peroxide (3% solution)	S	Sodium hydroxide (10%)	S
Carbon tetrachloride	U	Hydrogen peroxide (28% solution)	U	Sodium hydroxide (60%)	S
Chloroform	D	Isooctane	S	Sodium hydrochlorite (5%)	S
Chromic acid (40%)	U	Isopropyl alcohol (100%)	A	Sulfuric acid (3%)	S
Citric acid (10%)	S	Kerosene (no. 2 fuel oil)	S	Sulfuric acid (30%)	S
Cottonseed oil (edible)	S	Lacquer thinner	D	Sulfuric acid concentrate	U
Detergent Solution (Heavy Duty)	S	Methyl alcohol (50%)	A	Toluene	D
Diesel oil	S	Methyl alcohol (100%)	U	Trichloroethylene	D
Diethyl ether	U	Methyl Ethyl Ketone	U	Turpentine	S
Dimethyl formamide	U	Methylene chloride	D	Water (distilled)	S
Diocetyl phthalate	A	Mineral oil (white)	S	Xylene	D
Ethyl acetate	D				

This list does not include all possible chemical incompatibilities and safe compounds. Acrylic products should be cleaned with warm water, a mild detergent such as Alconox™, and can also be exposed to a mild bleach solution (10:1). In addition, RNase removal products are also safe for acrylic. Contact Technical Services with any questions.

Section 8 Optional Equipment

Multi-Load Tray & Combs

Multiple sample loading configured for use with an 8 channel pipette is available by using the multi load tray (B2-RL) and combs (B2-RL-9D).

Multiple Gel Caster

Pour multiple gels while the buffer chamber is in use. UVT gel trays fit snugly between the walls of the heavy duty gel caster (B1A-CST, B1-CST & B2-CST). Additional EasyCast UVT gel trays and combs are sold separately.

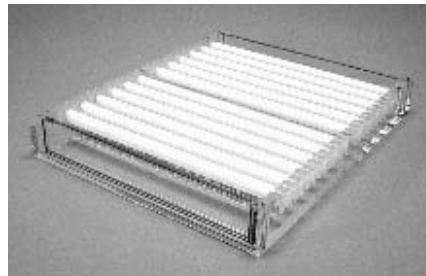

Figure 8-1. Multi-Load Tray

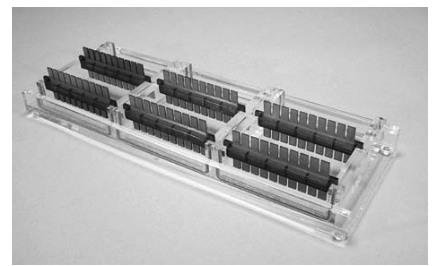

Figure 8-2. Multiple Gel Caster

Buffer Exchange Port Option for Models B1A, B1, And B2

The buffer exchange port option is used to recirculate the buffer during extended gel runs. Recirculation is used to prevent buffer depletion of certain low ionic running buffers, for extended runs, multiple sample sets, or for RNA gels. If your unit has the buffer exchange port option, it will be fitted with two white buffer port terminals and will contain two separate port inserts packaged in a small plastic bag located inside the unit upon arrival. Ports are attached to a user supplied pump.



Figure 8-3. Buffer Exchange Port Option

How These Work...

The inserts are pushed into the attached ports on the side wall of the unit with the black O-ring side facing in. The insert will “snap” into place in the port in the “open” position and is ready to circulate buffer. Appropriate tubing is then connected to the small outer ringed ends of the ports for circulation using a separate recirculator or peristaltic pump. To close the port, which also releases the insert, you simply press the flat metal button and the insert detaches. The port is now in the “closed” position.

Note Buffer may also be passed through a heat exchanger. ▲

Leveling Platform

The three point leveling platform, Model B-LP, ensures a flat casting and running surface. The platform is 46cm x 36cm and is large enough to fit most applications. One bubble level (BBL-1) is included.

Replacement Parts

Contact Technical Services to order replacement parts.

B1 Replacement Parts

<u>Item Description</u>	<u>Catalog No.</u>
-------------------------	--------------------

Complete System	B1A
-----------------	-----

Complete System with Buffer Exchange Ports	B1A-BP
--	--------

<u>Accessories</u>	<u>Catalog No.</u>
--------------------	--------------------

Power Supply Leads	PSL-5
--------------------	-------

Gasketed UVT Gel Tray	B1A-UVT
-----------------------	---------

Replacement Gaskets (1 pair)	B1A-GK
------------------------------	--------

External Caster (trays not included)	B1A-CST
--------------------------------------	---------

Leveling Platform (36cmW x 46cmL)	B-LP
-----------------------------------	------

Bubble Level	BBL-1
--------------	-------

B1 Replacement Parts

<u>Item Description</u>	<u>Catalog No.</u>
Complete System	B1
Complete System with Buffer Exchange Ports	B1-BP
<u>Accessories</u>	<u>Catalog No.</u>
Power Supply Leads	PSL-5
Gasketed UVT Gel Tray	B1-UVT
Replacement Gaskets (1 pair)	B1-GK
External Caster (trays not included)	B1-CST
Leveling Platform (36cmW x 46cmL)	B-LP
Bubble Level	BBL-1

B2 Replacement Parts

<u>Item Description</u>	<u>Catalog No.</u>
Complete System	B2
Complete System With Buffer Exchange Ports	B2-BP
<u>Accessories</u>	<u>Catalog No.</u>
Power Supply Leads	PSL-5
Gasketed UVT Gel Tray	B2-UVT
Gasketed Multi Load UVT Gel Tray 12 Slots	B2-RI-UVT
Gasketed Multi Load UVT Gel Tray 12 Slots With 12 Combs (B2-RI-9D)	B2-RL
Replacement Gaskets (1 pair)	B2-GK
External Caster (trays not included)	B2-CST
Leveling Platform (36cmW x 46cmL)	B-LP
Bubble Level	BBL-1

B3 Replacement Parts

Item Description**Catalog No.**
Complete SystemB3

Accessories**Catalog No.**
Power Supply LeadsPSL-5
Gasketed UVT Gel TrayB2-UVT
Gasketed Multi Load UVT Gel Tray
12 SlotsB2-RL-UVT
Gasketed Multi Load UVT Gel Tray
12 Slots With 12 Combs (B2-RL-9D)B2-RL
Replacement Gaskets (1 Pair)B2-GK
External Multiple Casting Chamber (trays not included) . . B2-CST
Leveling Platform (36cmW x 46cmL)B-LP
Bubble LevelBBL-1

Comb Options - Model B1A

Catalog Number	Comb Type	Number of Teeth	Thickness of Teeth	Width of Teeth	Recommended Loading Volumes* Gel Thickness			
					0.25cm	0.5cm	0.75cm	1.0cm
B1A-5C	Standard	5	1.0mm	11.3mm	8ul	30ul	51ul	72ul
B1A-5D	Standard	5	1.5	11.3	32	64	95	127
B1A-6	Double Sided	6	1.0, 1.5	9.1, 9.1	17, 26	34, 51	51, 77	68, 102
B1A-8	Double Sided	8	1.0, 1.5	6.4, 6.4	12, 18	24, 36	36, 54	48, 72
B1A-10	Double Sided	10	1.0, 1.5	4.7, 4.7	9, 13	18, 26	26, 40	35, 53
B1A-12	Double Sided	12	1.0, 1.5	3.7, 3.7	7, 10	14, 21	21, 31	27, 42
B1A-Prep	Prep	2	1.5	57/5	64/6	225/19	385/32	550/46
XCM	Custom		1.0, 1.5, 2.0, 3.0					

Loading Volume is calculated as 75% of total well volume (see page 15)

Comb Options - Model B1

Catalog Number	Comb Type	Number of Teeth	Thickness of Teeth	Width of Teeth	Recommended Loading Volumes* Gel Thickness			
					0.25cm	0.5cm	0.75cm	1.0cm
B1-5C	Standard	5	1.0mm	15.4mm	12UL	40UL	69UL	99UL
B1-5D	Standard	5	1.5	15.4	17	61	104	147
B1-8C	Standard	8	1.0	9.0	7	24	41	57
B1-8D	Standard	8	1.0	9.0	10	35	61	86
B1-10	Double Sided	10	1.0, 1.5	6.8, 6.8	5, 8	18, 27	31, 46	43, 65
B1-12C	Standard	12	1.0	5.4	4	14	24	34
B1-12D	Standard	12	1.5	5.4	6	21	36	52
B1-14	Double Sided	14	1.0, 1.5	4.4, 4.4	3, 5	12, 17	20, 30	28, 42
B1-Prep	Prep	2	1.5	78/5	90/6	310/19	525/32	750/46
XCM	Custom		1.0, 1.5, 2.0, 3.0					

*Loading volume is calculated as 75% of total well volume (see page 15)

Comb Options - Model B2 & B3

Catalog Number	Comb Type	Number of Teeth	Thickness of Teeth	Width of Teeth	Recommended Loading Volumes* Gel Thickness			
					0.25cm	0.5cm	0.75cm	1.0cm
B2-8C	Standard	8	1.0mm	12.5mm	9UL	33UL	56UL	80UL
B2-8D	Standard	8	1.5	12.5	14	49	84	120
B2-12**	Double Sided	12	1.0, 1.5	7.2, 7.2	5, 8	18,28	32, 49	46, 69
B2-16	Double Sided	16	1.0, 1.5	5.4, 5.4	4, 6	14,21	24, 36	34, 52
B2-20	Double Sided	20	1.0, 1.5	3.9, 3.9	3, 4	10, 15	18, 26	25, 37
B2-24	Double Sided	24	1.0, 1.5	3.0, 3.0	2, 3	8, 12	14, 20	19, 29
B2-RL-9D**	Micro Well	9	1.5	7.2	8	28	49	69
B2-Prep	Prep	2	1.5	106/5	120/5.5	415/20	710/34	1000/48
B2-Wall	Wall	1	1.5	120				
XCM	Custom		1.0, 1.5, 2.0, 3.0					

*Loading volume is calculated as 75% of total well volume (see page 15)

**8 & 12 Channel Pipette Format

THERMO FISHER SCIENTIFIC OWL PRODUCTS WARRANTY USA

The Warranty Period starts two weeks from the date your equipment is shipped from our facility. This allows shipping time so the warranty will go into effect at approximately the same time your equipment is delivered. The warranty protection extends to any subsequent owner.

During the first thirty-six (36) months, component parts proven to be non-conforming in material or workmanship will be replaced at Thermo's expense, including labor. Installation, calibration and certification is not covered by this warranty agreement. The Technical Services Department must be contacted for warranty determination and direction prior to performance of any repairs. Expendable items, glass, filters and gaskets are excluded from this warranty.

Replacement or repair of component parts or equipment under this warranty shall not extend the warranty to either the equipment or to the component part beyond the original warranty period. The Technical Services Department must give prior approval for return of any component or equipment. At Thermo's option, all non-conforming parts must be returned to Thermo postage paid and replacement parts are shipped FOB destination.

THIS WARRANTY IS EXCLUSIVE AND IN LIEU OF ALL OTHER WARRANTIES, WHETHER WRITTEN, ORAL, OR IMPLIED. NO WARRANTIES OF MERCHANTABILITY OR FITNESS FOR A PARTICULAR PURPOSE SHALL APPLY.
Thermo shall not be liable for any indirect or consequential damages including, without limitation, damages to lost profits or loss of products.

Your local Thermo Sales Office is ready to help with comprehensive site preparation information before your equipment arrives. Printed instruction manuals carefully detail equipment installation, operation and preventive maintenance.

If equipment service is required, please call your Technical Services Department at 1-800-438-4851 (USA and Canada) or 1-740-373-4763. We're ready to answer your questions on equipment warranty, operation, maintenance, service, and special applications. Outside the USA, contract your local distributor for warranty information.



Rev. 0 9/12

THERMO FISHER SCIENTIFIC OWL PRODUCTS WARRANTY INTERNATIONAL

The Warranty Period starts two months from the date your equipment is shipped from our facility. This allows shipping time so the warranty will go into effect at approximately the same time your equipment is delivered. The warranty protection extends to any subsequent owner.

During the first thirty six (36) months, component parts proven to be non-conforming in material or workmanship will be replaced at Thermo's expense, excepting labor. Installation, calibration and certification is not covered by this warranty agreement. The Technical Services Department must be contacted for warranty determination and direction prior to performance of any repairs. Expendable items, glass, filters and gaskets are excluded from this warranty.

Replacement or repair of component parts or equipment under this warranty shall not extend the warranty to either the equipment or to the component part beyond the original warranty period. The Technical Services Department must give prior approval for return of any component or equipment. At Thermo's option, all non-conforming parts must be returned to Thermo postage paid and replacement parts are shipped FOB destination.

THIS WARRANTY IS EXCLUSIVE AND IN LIEU OF ALL OTHER WARRANTIES, WHETHER WRITTEN, ORAL, OR IMPLIED. NO WARRANTIES OF MERCHANTABILITY OR FITNESS FOR A PARTICULAR PURPOSE SHALL APPLY.
Thermo shall not be liable for any indirect or consequential damages including, without limitation, damages to lost profits or loss of products.

Your local Thermo Sales Office is ready to help with comprehensive site preparation information before your equipment arrives. Printed instruction manuals carefully detail equipment installation, operation and preventive maintenance.

If equipment service is required, please call your Technical Services Department at 1-800-438-4851 (USA or Canada) or 1-740-373-4763. We're ready to answer your questions on equipment warranty, operation, maintenance, service, and special applications. Outside the USA, contract your local distributor for warranty information.



Rev. 0 9/12

Thermo Fisher Scientific
81 Wyman Street
P.O. Box 9046
Waltham, Massachusetts 02454-9046
United States

www.thermofisher.com

ThermoFisher
S C I E N T I F I C