

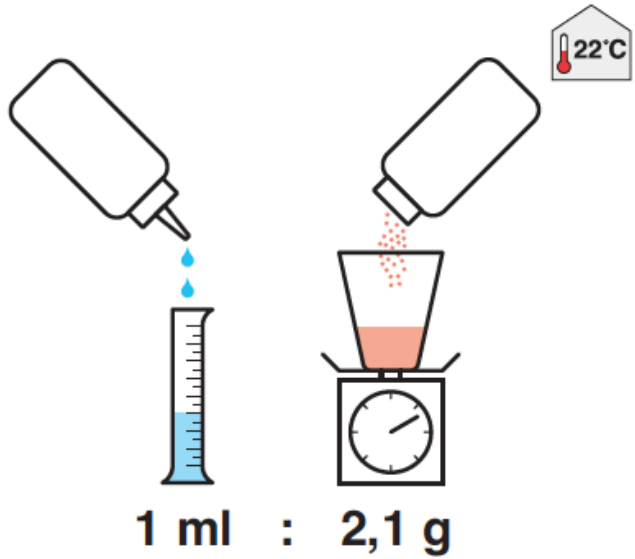

# Holland Dental Products Implacryl

1



En - Mix the ratio  
Fr - Taux de mixage

2

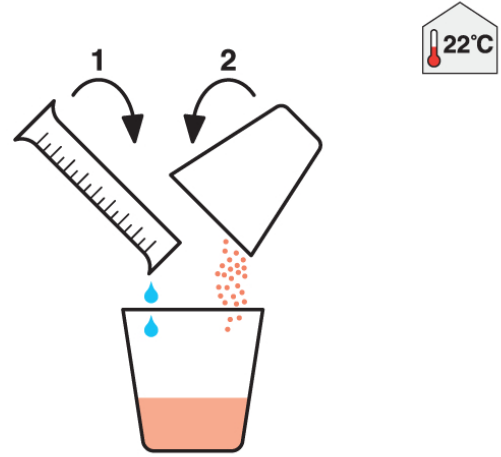

3

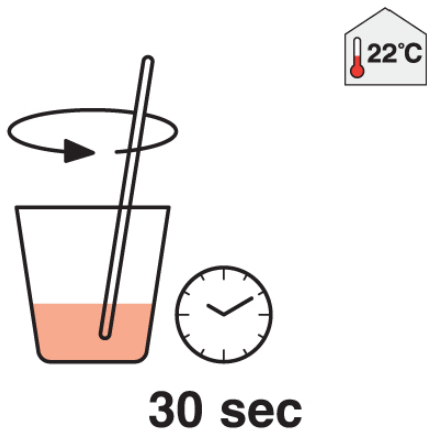

4



En - Dough time  
Fr - Temps de fermentation

5



**6**

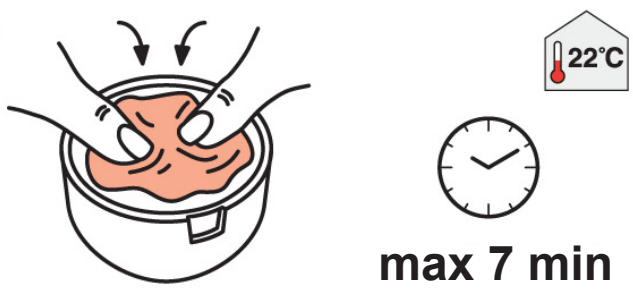

**max 7 min**

**En - Manual handing time**  
**Fr - Temps de traitement manuel**

**7**

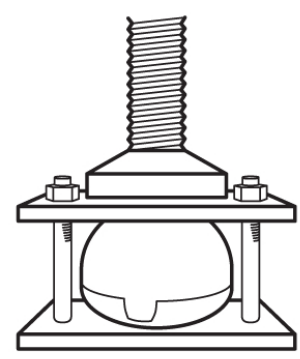

**8**

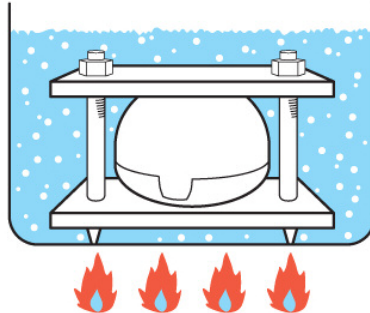
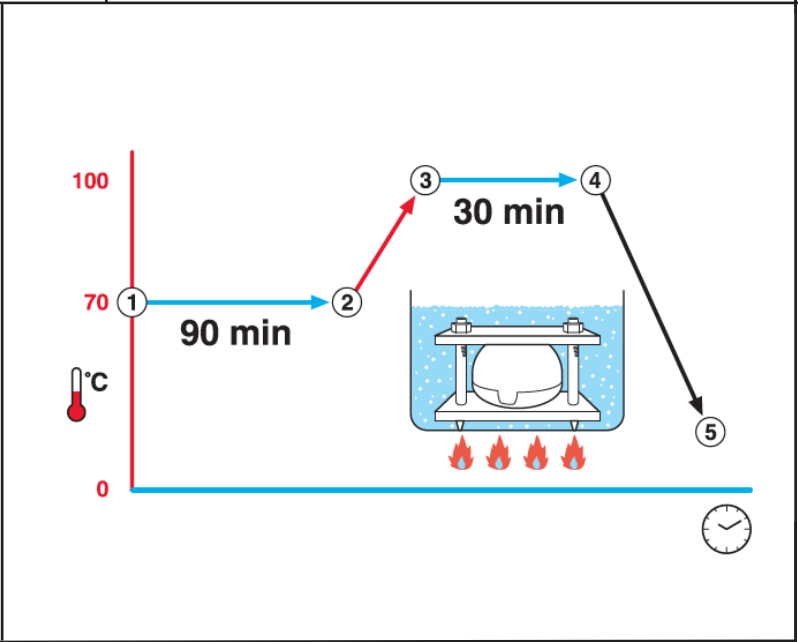
**En - ① Start curing process in hot water + Maintain water temperature ② Increase water temperature ③ Start curing + Maintain water temperature ④ Stop curing + Air cooling to ambient temperature ⑤ End of total curing process**

**Fr - ① Début du processus de traitement dans l'eau chaude + Maintien de la température de l'eau ② Augmentation de la température de l'eau ③ Début du traitement + Maintien de la température de l'eau ④ Fin du traitement + Refroidissement de l'air à la température ambiante ⑤ Fin de l'ensemble du processus de traitement**