

Flex 3S

HCP-S373A

Thank you for purchasing the FLEX 3S.
You can enjoy various types of massage for relieving or soothing fatigue.
We hope the FLEX 3S will be a valued partner in your daily health preservation for many years to come.

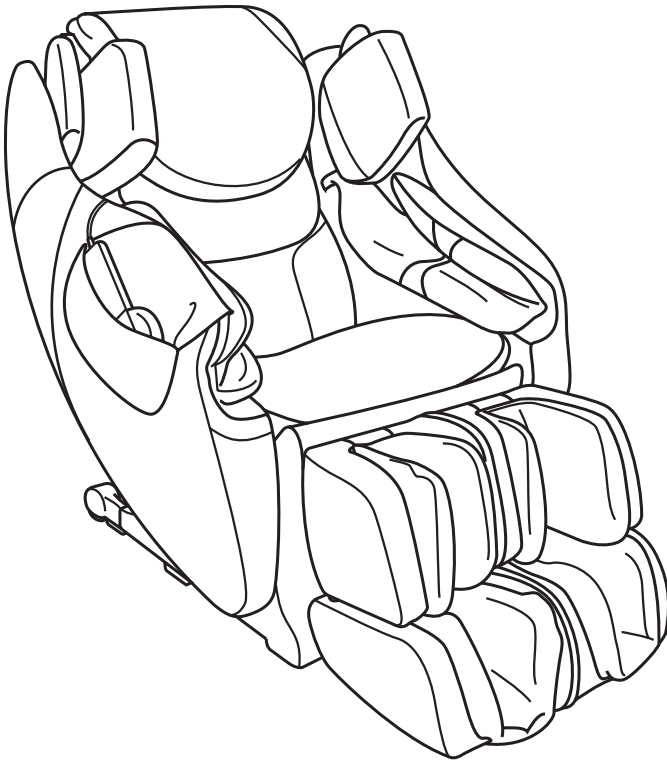

CONTENTS

■ SAFETY PRECAUTIONS	1
■ MAIN FEATURES	4
■ COMPONENTS & DESCRIPTION	5
■ BEFORE USE.....	7
■ POSITION ADJUSTMENT	12
■ AFTER USE	15
■ SESSIONS & SELECTION	16
■ PRESET SESSIONS	17
■ MANUAL SESSIONS	19
■ TROUBLESHOOTING.....	23
■ REGULAR MAINTENANCE FOR SAFETY ...	24
■ FAQ.....	25
■ CARE AND STORAGE.....	27
■ AFTER SALES SERVICE	28
■ SPECIFICATIONS	29



Operating Manual

Warranty card provided separately







- Please read this Operating Manual before use.
- Keep this Operating Manual nearby so that you can refer to it anytime.
- This product is designed for home use.

SAFETY PRECAUTIONS

Types of Indications





 Warning	This action could result in serious injury or death.
 Caution	This action could result in personal injury or damage to property.

Types of Symbols and Description







 Prohibited	Prohibited.	 Do not disassemble	Do not disassemble.
 No wet hands	Do not handle with wet hands.	 Do not wet	Do not use in a location where the chair may become wet.
 Prohibited	Do not use in a bathroom.		
 Required Action	Required action.	 Unplug the chair	Unplug the power plug from the wall outlet.

Remember to keep this Operating Manual in an easily accessible place.

Safety Precautions: Installation

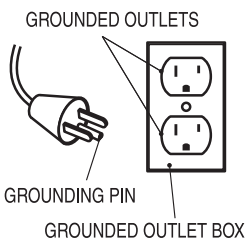



 Caution			
 Prohibited	<ul style="list-style-type: none"> ● Do not install the chair in an area of high humidity, such as a bathroom or sauna. → Could result in electric shock or damage to the chair. 	 Prohibited	<ul style="list-style-type: none"> ● Never connect the ground wire to gas pipes, water pipes, telephone lines, or lightning rods.
 Required Action	<ul style="list-style-type: none"> ● Install on a flat, level surface only. → Chair could tip over accidentally if placed on an uneven surface, resulting in an accident. 		

Safety Precautions: Installation

 Warning		
 Electrical grounding	<ul style="list-style-type: none"> ● Space Requirements This product must be grounded. If it should malfunction or breakdown, grounding provides a path of least resistance for electric current in order to reduce the risk of electric shock. This product is equipped with a cord having an equipment-grounding conductor and a grounding plug. The plug must be plugged into an appropriate outlet that is properly installed and grounded in accordance with all local codes and ordinances. • Improper connection of the equipment-grounding conductor can result in the risk of electric shock. Check with a qualified electrician or serviceman if you are in doubt as to whether the product is properly grounded. Do not modify the plug provided with the product if it will not fit the outlet; have a proper outlet installed by a qualified electrician. This product uses on a normal Alternating Current (AC) circuit and has a grounding plug that looks like the plug illustrated in the figure to the right. Make sure that the product is connected to an outlet having the same configuration as the plug. No adapter should be used with this product. 	 <p style="text-align: center;"> GROUNDED OUTLETS GROUNDED OUTLET BOX GROUNDED PIN </p>
 Required Action	<ul style="list-style-type: none"> ● Always unplug this appliance from the electrical outlet immediately after using and before cleaning. 	
 Caution		
 Prohibited	<ul style="list-style-type: none"> ● Do not operate under blanket or pillow. Excessive heating can occur and cause fire, electric shock, or injury to persons. ● Use this appliance only for its intended use as described in this Operating Manual. Do not use attachments not recommended by the manufacturer. ● Never operate this appliance if it has a damaged cord or plug, if it is not working properly, if it has been dropped or damaged, or dropped into water. Return the appliance to a service center for examination and repair. ● Do not carry this appliance by supply cord or use cord as a handle. ● Never operate the appliance with the air openings blocked. Keep the air openings free of lint, hair, and the like. ● Never drop or insert any object into any opening. ● Do not use outdoors. ● Do not operate where aerosol (spray) products are being used or where oxygen is being administered. ● Children should be supervised to ensure that they do not play with the appliance. 	
 Required Action	<ul style="list-style-type: none"> ● An appliance should never be left unattended when plugged in. Unplug from outlet when not in use, and before putting on or taking off parts. ● Close supervision is necessary when this appliance is used by, on, or near children, invalids, or disabled persons. ● Keep the cord away from heated surfaces. ● To disconnect, turn all controls to the off position, then remove plug from outlet. ● Keep children away from extended foot support (or other similar parts). ● Connect this appliance to a properly grounded outlet only. See Grounding Instructions. ● This appliance is not intended for use by persons (including children) with reduced physical, sensory or mental capabilities, or lack of experience and knowledge, unless they have been given supervision or instruction concerning use of the appliance by a person responsible for their safety. 	



Safety Precautions: Before Use

Warning

 Prohibited	<ul style="list-style-type: none"> ● The following persons must not use this massage chair: <ul style="list-style-type: none"> ○ Persons who have been instructed by a doctor to avoid massage therapy. Ex. Thrombosis, severe aneurism, acute varicosity, or dermatitis and/or skin infection including inflammation of the typodermis. ○ Persons with suspected acute neck sprain (whiplash injury) ● Do not use the chair with anything other than an AC 120 V power source. <ul style="list-style-type: none"> → May result in fire or electric shock. ● Do not use with any type of transformer device. <ul style="list-style-type: none"> → May result in damage to the chair or electric shock. ● Do not use the chair, if the power cord or plug is damaged, or if the wall outlet connection is loose. <ul style="list-style-type: none"> → May result in electric shock, short circuit, or combustion. ● Before each use, check for holes or tears in the chair covering. Also, check the other parts for tearing. Unplug the chair and contact the "Repair Service Center" (see back page) for assistance. Never use the chair with the chair covering removed or with holes or tears in the covering, because doing so is extremely dangerous. <ul style="list-style-type: none"> → Using the chair with holes or tears in the covering could result in injury or electric shock.
 Required Action	<ul style="list-style-type: none"> ● Persons with any of the following conditions should seek medical advice before using the chair: <ul style="list-style-type: none"> ○ Serious heart conditions ○ Sensory impairment caused by serious peripheral circulatory disorders due to diabetes and other diseases ○ Osteoporosis, spinal fractures, acute pain and/or symptoms thereof ○ Persons being treated for personal injuries ○ High fever (38°C (100°F) or higher) Ex. Strong acute inflammation illness caused by fatigue, chills, blood pressure fluctuation, or asthenia ○ Persons in the early stages of pregnancy, or immediately after giving birth. ○ Persons who have electronic medical device(s) easily susceptible to electromagnetic interference, e.g. pacemaker ○ Abnormal or curved spine ○ Persons planning to use the chair for treatment or for rehabilitation purposes ○ Persons with malignant tumor(s) ○ Persons under bed rest orders ○ Persons with acute gastro-intestinal complaints or ailments such as gastritis, enteritis, or hepatitis ○ Persons under a doctor's care, or those experiencing unusual physical discomfort ○ Joint dysfunction due to rheumatism, gout, or other diseases ○ Persons with symptoms such as qualm, dizziness, or tinnitus ○ Inflammation due to sprains, muscle strain, or other injuries ○ Persons with thecitis or suspected thecitis ○ Persons with thermoanesthesia ● Elderly people and persons with weak bones should seek medical advice before using the chair, even if they do not have a specific disease. ● If your condition does not improve after use, consult a doctor or specialist.
<h3> Caution</h3>	
 Prohibited	<ul style="list-style-type: none"> ● Do not use the chair in any way not prescribed by the Operating Manual. Do not use the chair together with any other therapeutic device or with an electric blanket. <ul style="list-style-type: none"> → May result in injury or have a negative effect on health. ● Do not move the chair while someone is in it. <ul style="list-style-type: none"> → Accident or injury may result if the chair tips over. ● Do not sit down on the chair with the leg rest raised. <ul style="list-style-type: none"> → Any sudden impact on the leg rest could cause damage to the mechanism. Also, an accident or injury may result if the chair tips over. ● Do not use with anything other than the accessories supplied with this product.
 Required Action	<ul style="list-style-type: none"> ● Before plugging the power cord into the wall outlet, make sure that the power switch is set to OFF. <ul style="list-style-type: none"> → May result in damage to the chair or electric shock. ● Make sure that the plugs on the power cord are inserted fully into the cord connector and the wall outlet. <ul style="list-style-type: none"> → May result in electric shock, short circuit, or combustion. ● Before using the chair for the first time, turn on all the switches in order as indicated in this Operating Manual to check that the chair is operating properly. ● Before using, raise the reclining seat to its fully upright position. Then recline the seat back slowly to the most comfortable position, remembering to start off with a lighter massage. <ul style="list-style-type: none"> → Starting with a deep massage may hurt the user. Elderly people and persons with weak bones should be especially careful when selecting massage intensity. ● For safety, sit down in the chair slowly without turning or twisting the body to ensure that the spinal rollers are placed at either side of the spine. ● Do not sit, stand, or lean on the leg rest unless you are sitting in or getting up from the chair. <ul style="list-style-type: none"> → Personal injury or damage to the chair may result if the chair tips over. ● If you use the chair after it has not been used for a long time, read this Operating Manual again thoroughly and check if the chair operates properly.

Safety Precautions: During Use



Warning

 Prohibited	<ul style="list-style-type: none"> ● Do not wrap the power cord or the remote controller cord around your body, or place the chair on top of either cord. Do not scratch, tear, treat, unduly twist, stretch or bend the power cord or the remote controller cord. <ul style="list-style-type: none"> → The cords may be damaged, resulting in fire or electric shock. ● Do not spill water and/or other liquids on the chair or remote controller. <ul style="list-style-type: none"> → May result in electric shock, short circuit, or combustion. ● Children and those who are unable to express their intentions should not use the chair. It is advisable to keep children and pets off the chair and away from the surrounding area (especially behind the reclining seat back or under the seat or leg rest). <ul style="list-style-type: none"> → Could result in accident or injury. ● Do not use the chair while more than one person is sitting in it. In particular, do not use the chair while holding a small child (or baby). <ul style="list-style-type: none"> → Could result in accident or injury. ● Do not use the chair while your body is wet, or with wet hands. <ul style="list-style-type: none"> → Could result in electric shock or damage to the chair. ● Do not use the chair if the covering is torn. If it is, unplug the power cord from the wall outlet. <ul style="list-style-type: none"> → Could result in an accident, injury or electric shock. For repairs, contact the "Repair Service Center" (see back page) for assistance. ● Do not release hands suddenly while lifting the leg rest by hand.
 Required Action	<ul style="list-style-type: none"> ● Make sure no one, especially children or pets, is in the way when lowering or raising the reclining seat back. Be careful that people or objects are not caught behind the seat back or under the leg rest.

SAFETY PRECAUTIONS



Safety Precautions: During Use

⚠ Caution

 Prohibited	<ul style="list-style-type: none"> ● Do not use the chair unclothed. ● Do not use the chair for purposes other than massage, or other than the ordinary uses of a chair. → Could result in accident or injury. ● Do not use the chair to massage the head, chest, stomach, and/or joints (knees, elbows). → May result in nausea or injury. Place a soft towel behind your neck if you want to avoid intense stimulation of the area. ● Do not place your hands or feet into the roller tracks, into the space between the seat back and the seat or into the moving parts. Do not sit wearing hard objects, such as hair accessories, or a necklace, watch, bracelet or ring. → May result in personal injury. ● Do not place anything other than legs and feet on the leg rest. → May result in personal injury. ● Do not operate the massage chair or leave it operating when there is no one in it. → Could result in accident or injury.
 Required Action	<ul style="list-style-type: none"> ● In an emergency, or if you find any abnormal condition, push the EMERGENCY STOP button on the remote controller to stop operation immediately. ● If you get acute pain or other unusual physical discomfort while using the chair, immediately discontinue the use of the chair and seek medical advice. ● If you feel the massage is too strong, reduce the stimulation according to this Operating Manual. If this solution does not work, stop operation immediately and contact the "Repair Service Center" (see back page) for assistance. → May result in injury if you continue use with high stimulation under such circumstances. ● Do not use with the back pad removed. → May result in personal injury. ● Do not fall asleep in the chair during a massage session. → May result in personal injury. ● Keep massage sessions to no longer than 15 minutes. Do not exceed 5 minutes for an area-specific massage of any particular part of the body. → Continuous use for extended periods of time can result in over-stimulation, which could cause the opposite of the desired effect, or even injury. The total amount of time for a daily massage should be limited to about 30 minutes keeping appropriate intervals between each massage session. ● If your leg or foot comes out of the leg rest during the massage, do not try to force it back in. → Undue force may result in damage to the mechanism. ● If your arm comes out of the upper arm unit or forearm unit during the massage, do not try to force it back in. → Undue force may result in damage to the mechanism.
 Unplug the chair	<ul style="list-style-type: none"> ● If there is a power outage or the possibility of a power outage, stop the chair immediately and turn the main POWER switch to OFF. Unplug the power plug from the wall outlet. → Accident or injury may result if the chair is still in operating mode when the power resumes. ● If there is a threat of lightning, stop operation immediately and turn the main POWER switch to OFF. Unplug the power plug from the wall outlet. ● If an operation does not start, or if you find any abnormality, stop the chair immediately and turn the main POWER switch to OFF to prevent an accident. Unplug the power plug from the wall outlet. Contact the "Repair Service Center" (see back page) for assistance. → Electric shock or fire caused by a short circuit may result if the chair is left plugged in under such circumstances.



Safety Precautions: After Use or When Not in Use

⚠ Caution

 Prohibited	<ul style="list-style-type: none"> ● Be sure to turn the Main POWER switch to off after every use and to unplug the power plug from the wall outlet. → An accident or injury may result if children or pets play with the chair. ● Do not use the power cord for any other products. ● After using the chair, be sure to return the reclining seat back to its upright position and lower the leg rest to its lowest position. ● Wipe the chair off after every use, and store the chair in a place with low humidity. ● Do not place any object on the chair.
 Unplug the chair	<ul style="list-style-type: none"> ● Hold the power plug when unplugging from the wall outlet. Do not pull on the power cord. → May result in electric shock or fire caused by short-circuiting. ● When cleaning the chair, make sure to unplug the power plug from the wall outlet first. Do not plug or unplug the power plug with wet hands. ● If the chair is left unused for a while, be sure to unplug it from the wall outlet. → Insulation degradation by dirt or moisture may cause electric shock, or fire due to short-circuit.

Other Precautions

⚠ Warning

 Prohibited	<ul style="list-style-type: none"> ● Do not stand on the chair. Do not make a major impact or sit on any part of the chair other than the seat. → Personal injury or damage to the chair may result if the chair tips over.
 Do not disassemble	<ul style="list-style-type: none"> ● Do not try to repair any malfunction of the chair. Contact your local Inada distributor (see back page) for assistance. ● For safety, if the power cord is damaged contact the "Repair Service Center" (see back page) for assistance. ● Do not modify or remodel the chair. → May result in fire, electric shock, or injury.

⚠ Caution

 Required Action	<ul style="list-style-type: none"> ● If you lend, sell, or otherwise transfer the chair to another party, make sure to include this Operating Manual.
--	---

Note

- **Before disposing of the product or its accessories, consult your local authorities about the proper procedure.**

MAIN FEATURES

Main Features

Compact and high-performance

New Hybrid Massage Function

The chair has a compact, high-performance design enabling a roller massage from the shoulders to the lower back, and an air massage of the buttocks and legs, and also from the shoulders to the fingertips.

Optic sensors provide for

Automatic Shiatsu Point Locator Function

Automatically locates shiatsu points which vary from person to person. This allows for an effective massage that tailors itself to your size and shape.

Easy-to-see LED

Stylish Remote Control

An LED lights up for the selected session, making the buttons easy to understand and use. Also, the remote control semicircle area displays LEDs for the shoulder position search and operations inside the panel of the remote control.

Easy to adjust to the most comfortable position

Automatic Reclining Function

The seat back can be reclined to any angle between approx. 115° and 165° from the floor. The angle of the leg rest also can be adjusted up to approx. 90° according to your preference.

Air massage kneading

Full Body Air Massage Function

The chair performs a full body air massage from the leg rest that massages the feet and calves, seat that massages the buttocks, and arm/shoulder units that massage from the shoulders to the fingertips.

Boost the power with just one button

Addition of a Max Intensity Mode

In addition to intensity adjustment using individual buttons as in previous models, a Max Intensity mode button has been added that can boost the overall power of a massage with just one touch. When a preset session or manual session is selected, the massage operation can be changed to Max Intensity mode.

New mechanism

Equipped with a Mechanical Arm 3-D Mechanism

The intensity of the mechanical arm can be adjusted with an air bag, enabling the kneading intensity to be controlled.

Relieve any kind of fatigue

Various Session Functions

Preset Sessions allow you to select the optimal session according to your purpose, while the manual session mode allows you to combine functions to suit your particular needs.

Warm on hand and foot

Heater for Fingers and Toes

The chair is equipped with heaters for the fingertips and toes.

Benefits

As a therapeutic massage device for household use, the Inada Chair provides the following benefits:

- Relieves fatigue
- Alleviates muscle fatigue
- Relieves muscle pain
- Improves blood circulation
- Relieves muscle aches

COMPONENTS & DESCRIPTION

Chair

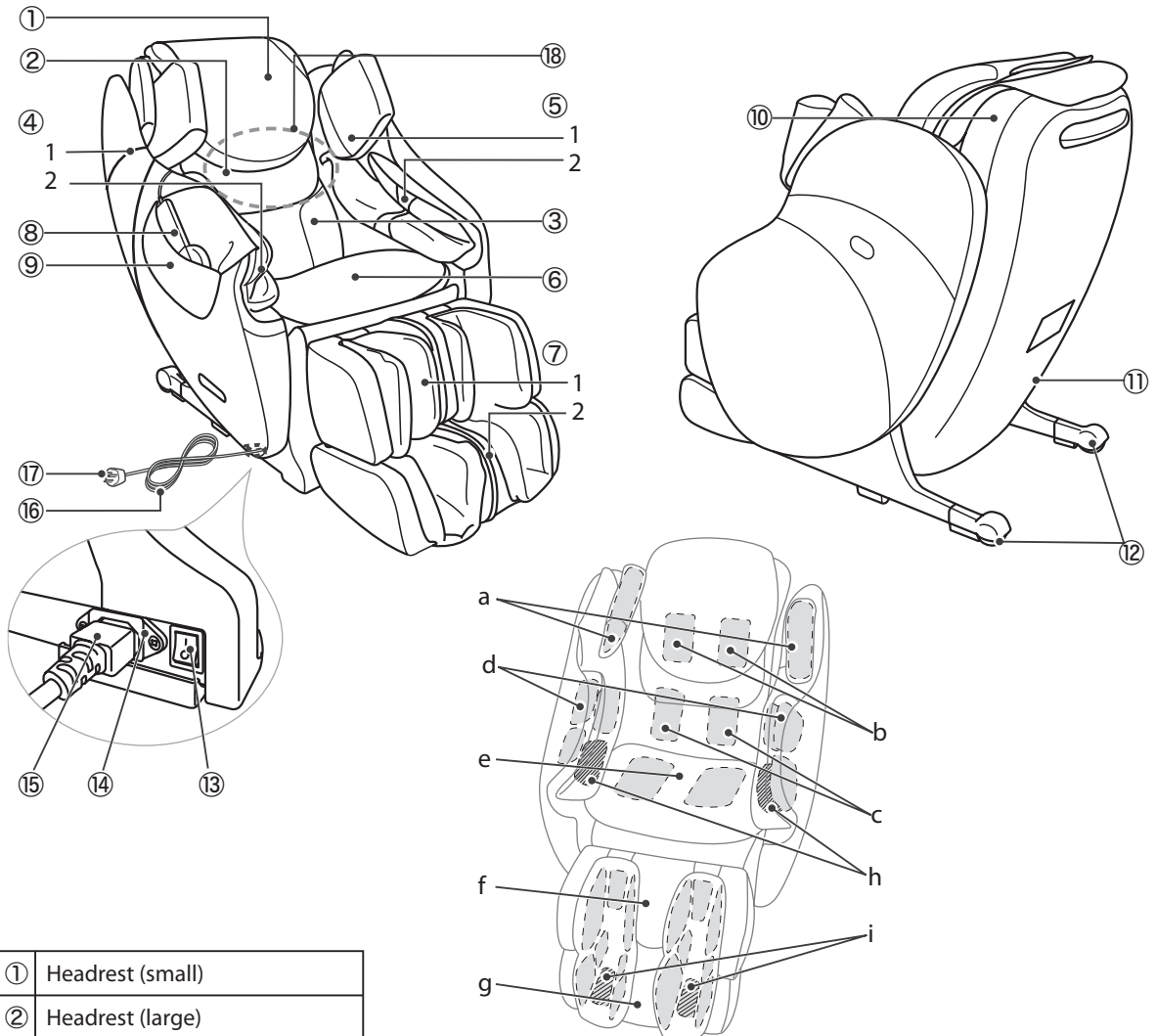

[COMPONENTS & DESCRIPTION]

①	Headrest (small)
②	Headrest (large)
③	Back Pad
④	Armrest (right)
• 1	Shoulder Unit
• 2	Arm Unit
⑤	Armrest (left)
• 1	Shoulder Unit
• 2	Arm Unit
⑥	Seat
⑦	Leg Rest
• 1	Calf Unit
• 2	Foot Unit
⑧	Remote Control

⑨	Remote Control Pocket
⑩	Reclining Seat Back
⑪	Back Cover
⑫	Wheels
⑬	Main POWER Switch
⑭	Power Connector
⑮	Cord Connector
⑯	Power Cord
⑰	Plug
⑱	Rollers Normally stored inside the upper part of the seat back.

a	Arm Air Cushion /2 each on left and right
b	Seat Rear Air Cushion /1 each on left and right
c	Lower Back Air Cushion /1 each on left and right
d	Arm Air Cushion /4 each on left and right
e	Seat Air Cushion /x 2
f	Calf Air Cushion /x 6
g	Foot Air Cushion /x 10
h	Palm Heater /1 each on left and right
i	Foot Cover Heater /1 each on left and right

Remote Control

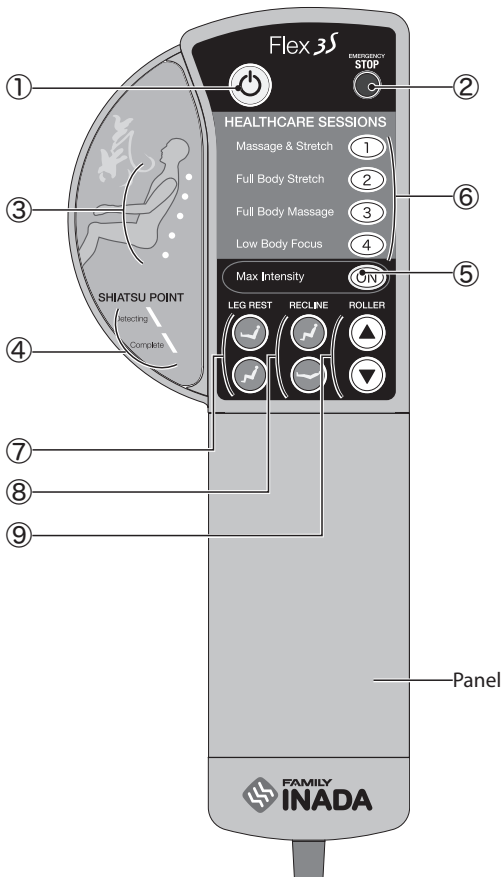

①	Button	Turns the remote control power ON and OFF. Pushing the POWER button while the chair is activated causes the rollers to return to the starting position, after which the chair turns itself off. The button lights in green while the power to the remote control is ON, lights in orange while the power is OFF, and flashes in red while the chair is stopped in an emergency.
②	EMERGENCY STOP Button	Use this button to shut the chair off immediately in an emergency or if there is a malfunction during operation of the chair. The rollers will stop immediately.
③	Roller Position Display	The position of the roller during the massage is displayed.
④	Shiatsu Point Locator Indicator	A light indicates when the shiatsu point locator is operating and when the operation has finished.
⑤	Max Intensity Mode Button	Selects Max Intensity mode.
⑥	Preset Session Buttons 1	Selects the corresponding session.
⑦	Leg Rest Button	Use to adjust the angle of the leg rest.
⑧	Reclining Button	Use to adjust the angle of the reclining seat back.
⑨	ROLLER-Position Adjustment Buttons	Use to adjust the shoulder position while the shiatsu point locator is operating, and to adjust the roller position during manual session mode.

[COMPONENTS & DESCRIPTION]

Remote Control/Inside the Panel

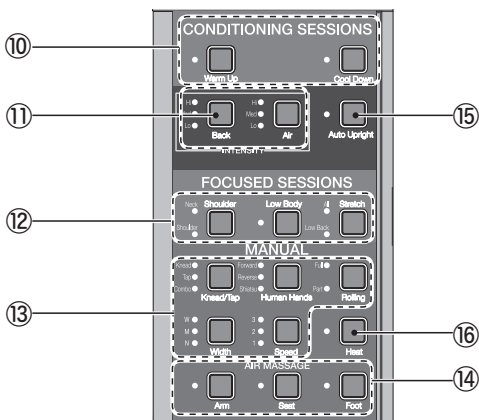

⑩	Preset Session Buttons 2	Selects the corresponding session.
⑪	Intensity Adjustment Buttons	Adjusts the mechanical and air massage intensity.
⑫	Focused Sessions Buttons	Special operations can be selected.
⑬	Manual Sessions Buttons	Basic operations can be selected.
⑭	Air Massage Buttons	Selects among arm, back or leg air massage. *These 3 air massage types can all be selected at the same time.
⑮	Automatic Raise Cancel Button	The automatic seat reclining raise operation when the session is completed can be set ON/OFF.
⑯	Hand and Foot Heater Button	The hand and foot heater can be switched ON/OFF.



Warning

- Do not spill water and/or other liquids on the remote control.
- Do not handle the remote control with wet hands.



Caution

- Do not sit on the remote control. Do not drop or step on the remote control. Do not pull the remote control cord forcibly.
- Do not use pointed or hard objects to push the buttons.
→May result in damage to the remote control.

BEFORE USE

- This product is shipped with the reclining seat back in its fully reclined position. Be sure to raise the seat back to its fully upright position.
- Do not expose the chair to sudden bursts of heat. If the room where the chair is to be used is cold, turn the heat up slowly. If the chair is moved from a cold place into a heated room, wait one hour before using the chair.
→Condensation could occur in the moving parts of the chair, which may compromise performance.

Installation

Allow for at least 50 cm (20 inch) clearance behind and in front of the chair when reclining so as to be able to recline the seat back fully without obstruction.



Caution

- Do not install the chair in an area of high humidity, such as a bathroom or sauna.
- Install on a flat, level surface only.
- Do not use in areas of high debris or dust content. Do not use where the ambient temperature is 40°C (104°F) or over.
- Do not install the chair where it can come into contact with direct heat, such as direct sunlight or a radiator.
- Keep fire sources such as cigarettes and ashtrays away from the chair.

- To avoid damaging floor surfaces and to minimize the chair noise, it may be better to install the chair on a carpeted surface or to lay a piece of carpet under the chair.
(Do not install on an electric carpet.)
- The chair is heavy, so please be careful when unloading it so as not to damage floor surfaces.
- Install the chair at least 1 m (39 inch) away from TVs, radios, and other audio or video equipment. Otherwise they may make noises affected by the operation of the chair.
- The load to the floor per 1 cm² (0.15 inch²) is approximately 2.3 kg (5.1 lb), with a person weighing 100 kg (220 lb) sitting on the chair.

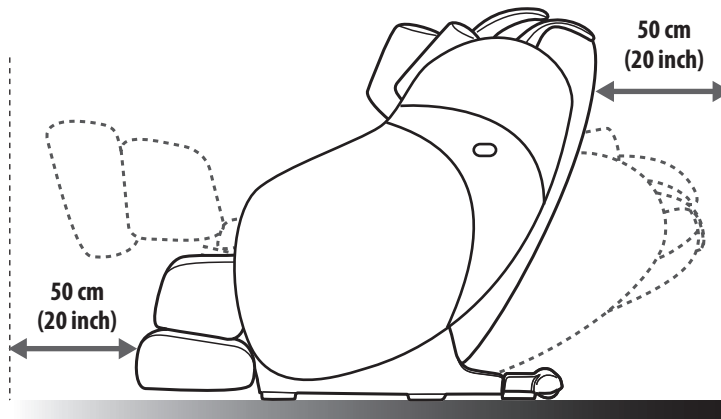

Checking the Supplied Items

Check that the chair and the other items are all in the package.

*This product is shipped with the armrests being installed.

For removing the armrests, see page 8.

Chair

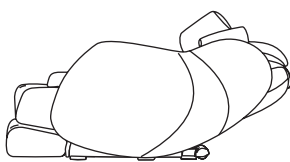

Chair

Items Included



Operating Manual
(this document)



AC Cord



Buffer Pad



Shiatsu Balls

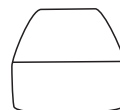

Remote Control Pocket



T-shaped Wrench

How to Remove and Install the Armrests

If the clearance of the transportation passageway is less than 87 cm (34 inch), removing the armrests is recommended before transporting the chair.

Minimum product width when armrests installed: Approx. 83 cm (32 inch)

Minimum product width when armrests removed: Approx. 61 cm (24 inch)

For safety, before removing or installing the armrests, turn off the main power and disconnect the power cord connector from the power connector on the chair.

*For installation, perform the procedure in reverse.

Read the installation precautions carefully.

① Open the zipper on the armrest.

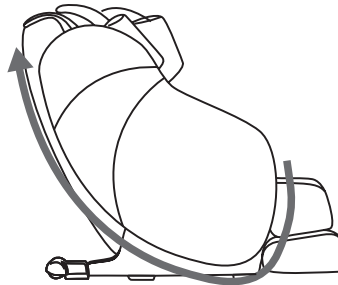
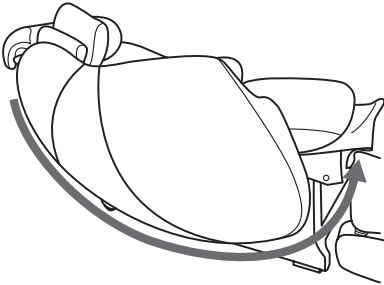

● Installation precautions

Insert the power cord into the power connector, turn on the main power and use the reclining button on the operating mechanism to raise the chair to its fully upright position. Then, pull the leather by hand to straighten out the wrinkles, and close the zipper.

*For details on turning on the main power, see page 10.

② Remove the air hose and harness.

● Installation precautions

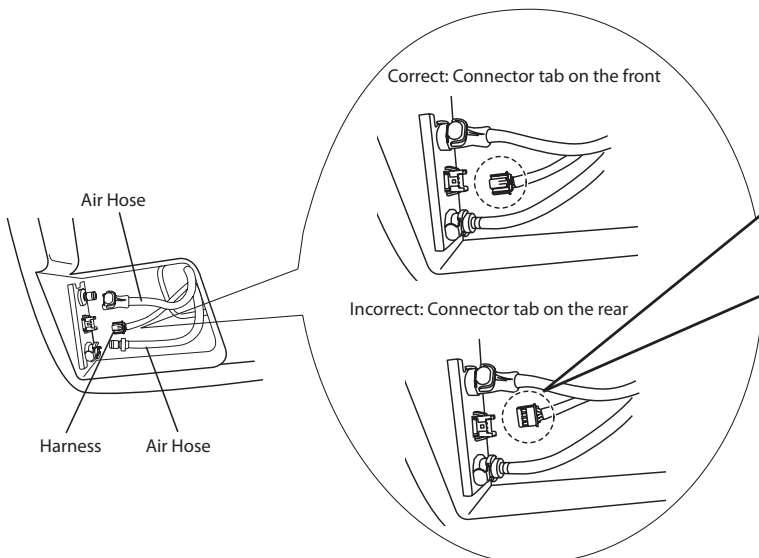

⚠ Caution

- To prevent disconnection, be sure to check the connection after connecting by gently pulling on the connector.
- If the connector is not connected properly, an error is generated. After connecting, be sure to turn on the main POWER switch to check for errors.

BEFORE USE

③ Remove the screws and washers. (3 locations on each side, shown by the dotted line circles)

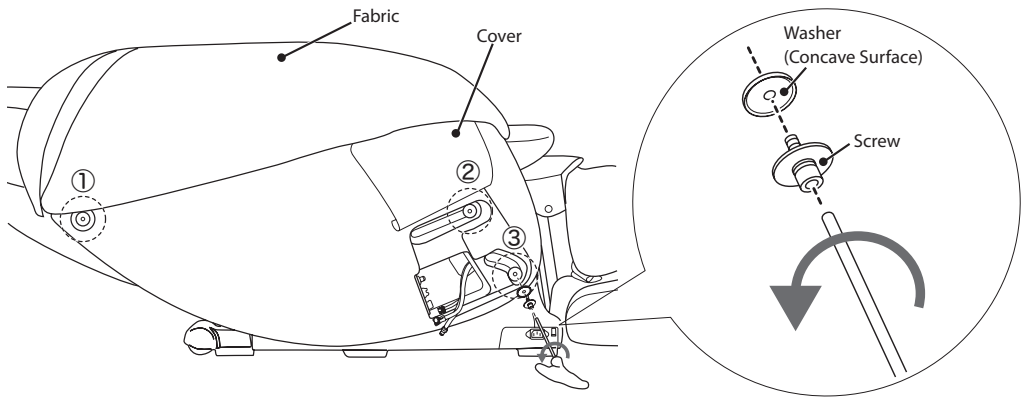

● Installation precautions

Install by using the T-shaped wrench in the direction shown in the diagram. (Ensure that the washer direction is correct.)

If the screw is installed at an angle, the threads may be crushed.

Make sure it is not at an angle.

④ Remove the armrest in the order of a, then b.

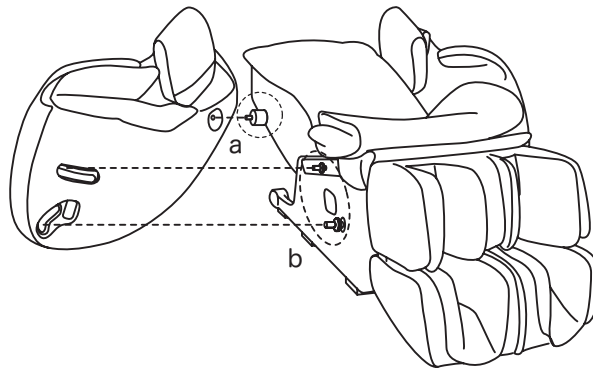

● Installation precautions

Pass the air hose and harness through the rectangular hole on the armrest. (3 on each side)

*Be careful not to use the wrong hole.

Align the shaft on the chair with the hole on the armrest, and insert the armrest.

*Make sure that the operating mechanism cable does not pass between the chair and the armrest.

The operating mechanism cable may break.

*Make sure that the fabric on the inner side of the armrest is not caught by the shaft.

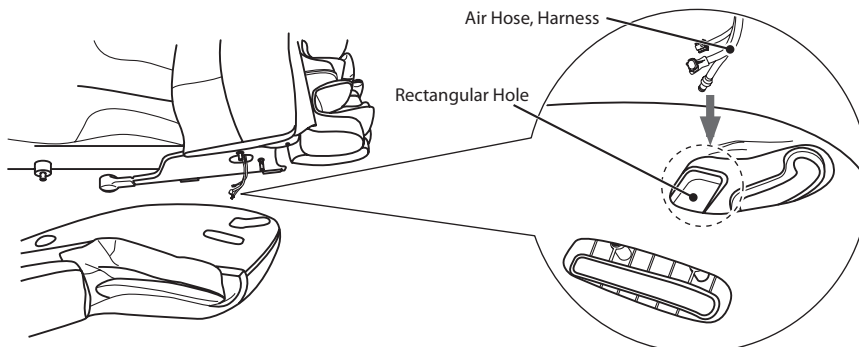

[BEFORE USE]

How to Transport or Move the Chair

Before moving the chair, turn off the main power, unplug the power plug from the wall outlet, and also disconnect the power cord connector from the power connector on the chair.

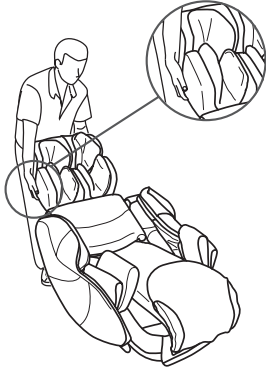
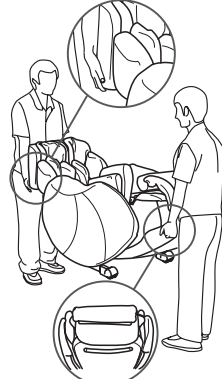
To Move with the Wheels	To Carry
<p>Raise the reclining seat back to its upright position, hold the sides of the leg rest, and then move the chair on the wheels by lifting and holding up the front part of the chair.</p>	<p>Fully recline the seat back and carry the chair by holding the handle on the upper part of the back cover and the sides of the leg rest.</p>
	

- The chair is very heavy, so be careful not to hurt your lower back when transporting or moving it.
- The remote control is attached to the chair, so make sure that it does not fall when moving the chair.

 Caution	<ul style="list-style-type: none"> ● Do not move the chair while someone is in it. ● Before moving the chair, turn off the main power, unplug the power plug from the wall outlet, and also disconnect the power cord connector from the power connector on the chair. →The power cord may be damaged, resulting in fire or electric shock.
---	---

[BEFORE USE]

Main Power Connection

- ① First, plug the power cord into the cord connector located at the front right of the chair. Then, plug the other end into the wall outlet.

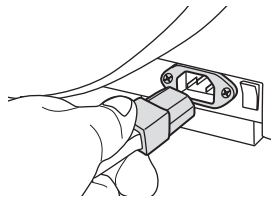

- ② Set the main POWER switch located on the right side of the chair set to ON.

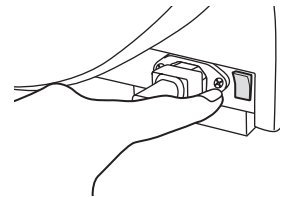

*If the main POWER switch is turned ON while the rollers are stopped partway, they will automatically return to the starting position (upper part of the seat back) and then stop.

 Warning
<ul style="list-style-type: none"> ● Do not use with any type of transformer device. →May result in damage to the chair or electric shock.

 Caution
<ul style="list-style-type: none"> ● Before plugging the power cord into the wall outlet, make sure that the power switch is set to OFF. ● Make sure that the plug on the power cord is inserted fully into the wall outlet. ● Before using the chair for the first time, turn on all the switches in order as indicated in this Operating Manual to check that the chair is operating properly.

BEFORE USE

Checking the Seat Cover

Before using the chair, check the seat cover for tearing with the following procedure.

① Peel open the Velcro at the top.

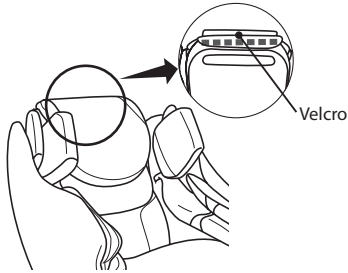

② Fold the back pad forward, and check by touching with your hands that the chair fabric is not damaged.

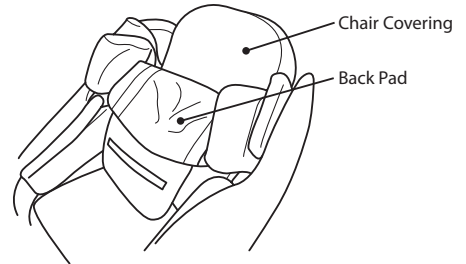

[BEFORE USE]



Caution

● Be sure to check for tearing on the chair before every use, as shown in the illustration. Also, check the other parts for tearing. Unplug the chair and contact the "Repair Service Center" (see back page) for assistance. Never use the chair with the chair covering removed or with holes or tears in the covering, because doing so is extremely dangerous.

How to Install the Remote Control Pocket

Attach the supplied remote control pocket to the arm rest (right) as shown in the diagram below.

① Place the remote control pocket on the armrest (right).

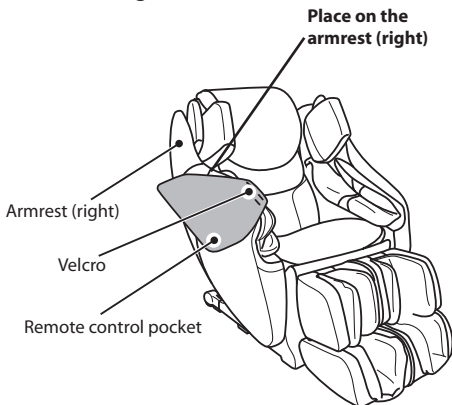

② There is Velcro for installing the remote control pocket on the inside of the armrest (right). Wrap the remote control pocket around the armrest (right) to install it.

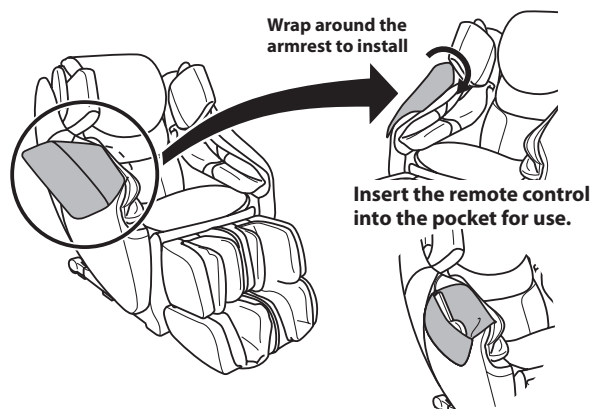

POSITION ADJUSTMENT

How to Sit

When the chair is off, the rollers are normally drawn back into the left and right sides of the upper part of the seat back (Storage Position). For safety, first check the position of the rollers. If they are in any position other than the storage positions, turn the main POWER switch ON before sitting down to allow the rollers to return to their storage position. When you finish checking, sit down slowly in the center of the seat.



Caution

- Do not sit down on the chair with the leg rest raised.

→ Any sudden impact on the leg rest could cause damage to the mechanism. Also, an accident or injury may result if the chair tips over.

- Before using, raise the reclining seat to its fully upright position. Then recline the seat back slowly to the most comfortable position, remembering to start off with a lighter massage.

Headrest (Small) Adjustment

Use the headrest (small) by matching it to the position of your head.

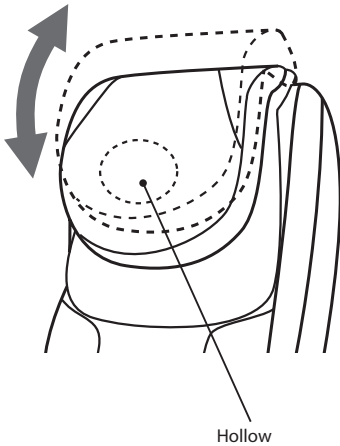

Proper Position of Small Headrest

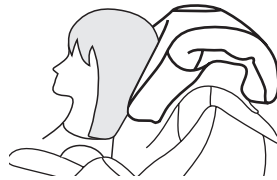

The hollow in the headrest (small) does not make contact with the back of the head.



The back of the head is placed in the hollow in the headrest (small).

POSITION ADJUSTMENT

Removing the Headrest Cover

The headrest cover attached to the headrest (small) can be removed by following the procedure below.

- ① Bend the headrest.

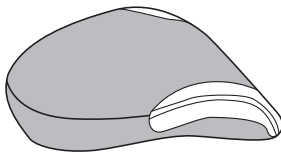

- ② Remove the headrest from the side.

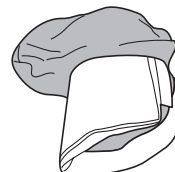

*Be careful at this time, because the headrest cover may tear if you turn it over with excess force.

*To install, repeat the procedure in the reverse order.

POSITION ADJUSTMENT

How to Use the Buffer Pad

If you feel that the massage is too intense, place the supplied buffer pad onto the back pad and start the massage again.

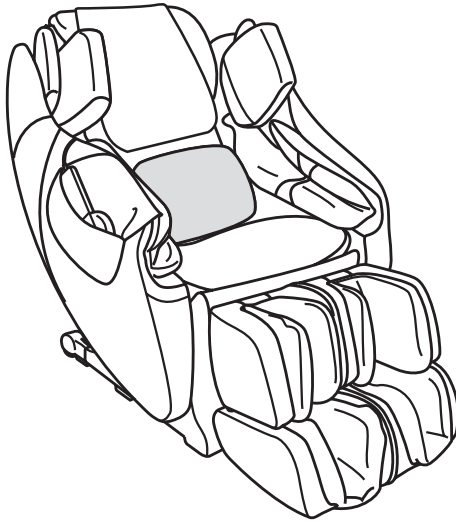

Caution

- Make sure that the buffer pad does not curl up or become lop-sided.
→ May result in accident or injury.

How to Use the Shiatsu Balls

Place the provided shiatsu balls into the special pocket in the foot unit leg rest for use. There is a heel side and toe side to the special pocket. Insert the shiatsu balls according to your preference.

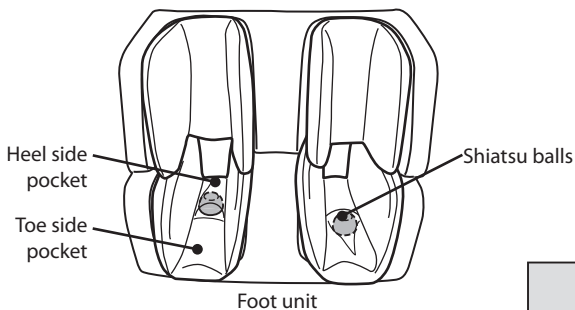

- Remove the shiatsu balls if you want to make the massage lighter.

How to Use the Armrest

Place your arm as shown in the diagram below so that your elbow is between the arm unit and shoulder unit.

- Rotate the shoulder unit to the desired position before starting the massage.
- Place your elbows between the arm unit and shoulder unit.
- Insert so that your palm is facing down.

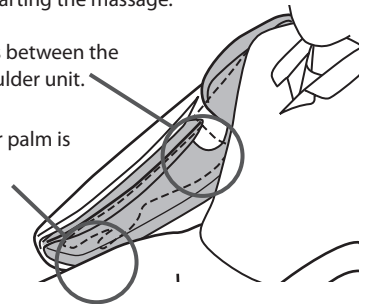

Caution

- Do not use the shoulder unit and arm unit for anywhere other than your shoulders and arms respectively.
→ May result in personal injury.
- If your arm comes out of the shoulder unit or arm unit during the massage, do not try to force it back in.
→ Undue force may result in damage to the mechanism.
- Do not massage your elbows. Also, be sure that your palms are facing down when massaging your arms.
→ May result in personal injury.

How to Use the Leg Rest

Vertical Adjustment

■ To raise the leg rest

Press the top LEG REST button to raise the leg rest.

■ To lower the leg rest

Press the bottom LEG REST button to lower the leg rest.

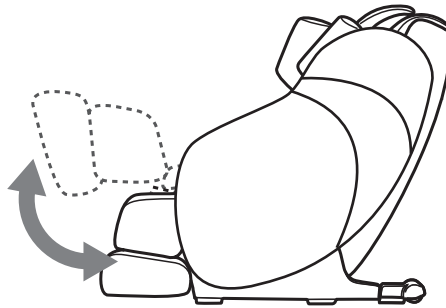

Hold Function

When you press the button for approximately 2 seconds, the leg raise (lower) operation automatically operates.

If it stops mid-operation, press the button again.

Leg Rest Extension and Retraction

When you sit in the chair and raise the leg rest to the specified height, it automatically adjusts.

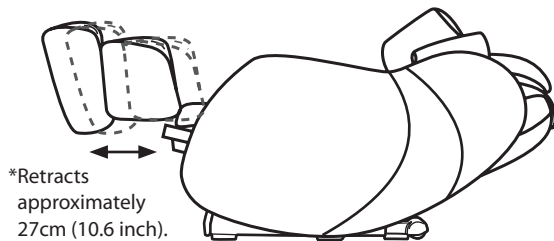

⚠ Warning

- Make sure no one, especially children or pets, is in the way when lowering the leg rest. Be careful that people and/or objects are not caught under the leg rest.
- Do not release your hands suddenly while lifting the leg rest by hand.

⚠ Caution

- Do not place anything other than legs and feet on the leg rest.

POSITION ADJUSTMENT

How to Use the Reclining Seat Back

■ To raise the reclining seat back

Press the top RECLINE button to raise the reclining seat back.

■ To lower the reclining seat back

Press the bottom RECLINE button to lower the reclining seat back.



Reclining Movement Range

The chair reclines up and down in conjunction with the movement of the seat back and leg rest.

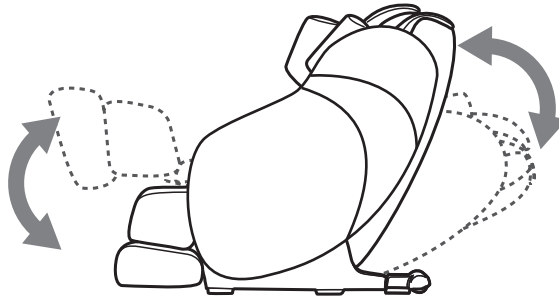

Hold Function

Hold the button for about 2 seconds to raise (or lower) the reclining seat back automatically*.

If it stops mid-operation, press the button again.

*The seat back and leg rest move to their maximum positions and then stop.



Warning

● Make sure no one, especially children or pets, is in the way when lowering the reclining seat back. Be careful that people and/or objects are not caught behind the reclining seat back.

How To Use The Heater

Press the Heat button to turn on the heater.

The button light also turns on.

Press the button to turn the heater on or off.



AFTER USE

While making sure there is nothing in the surrounding area, return the reclining seat back to its upright position and lower the leg rest to its lowest position.

Turn off the main POWER switch on the front right of the chair!

Unplug the power plug from the wall outlet. This will save energy because no standby power will be consumed.



Caution

- Be sure to turn the main POWER switch to off after every use and to unplug the power plug from the wall outlet.
→An accident or injury may result if children or pets play with the chair.
- After using the chair, be sure to return the reclining seat back to its upright position and lower the leg rest to its lowest position.
- Wipe the chair off after every use, and store the chair in a place with low humidity.
- Hold the power plug when unplugging from the wall outlet. Do not pull on the power cord.
- If the chair is left unused for a while, be sure to unplug it from the wall outlet.
- Be careful not to tangle yourself in the cords and trip over.

SESSIONS & SELECTION

Preset Sessions

The preset sessions make it easy to select a session that suits your preferences or objectives.

Healthcare Sessions

These sessions are for recovering from muscle fatigue.

Massage & Stretch

This session includes light stretching in a full-body massage.

Full Body Stretch

This session includes light stretch actions where the entire body is stretched.

Full Body Massage

This session is recommended for persons who feel symptoms such as lack of energy or fatigue.

Low Body Focus

This massage is focused on the lower half of the body.

Conditioning Sessions

Warm Up

This session is for gently stretching your muscles before exercise. It can also help to wake up your body in the morning.

Cool Down

This session is for balanced stretching of your muscles after exercise. We recommend using this session to prevent any next-day fatigue.

Focused Sessions Manual Sessions

You can combine your favorite massage types. You can also adjust the speed, intensity, and roller positions.

PRESET SESSIONS

Preset Session Messages

- 6 automatic sessions provide a variety of different massages to relieve fatigue.
- With the preset session buttons, you can choose your favorite session to give you a massage according to the preset menu.

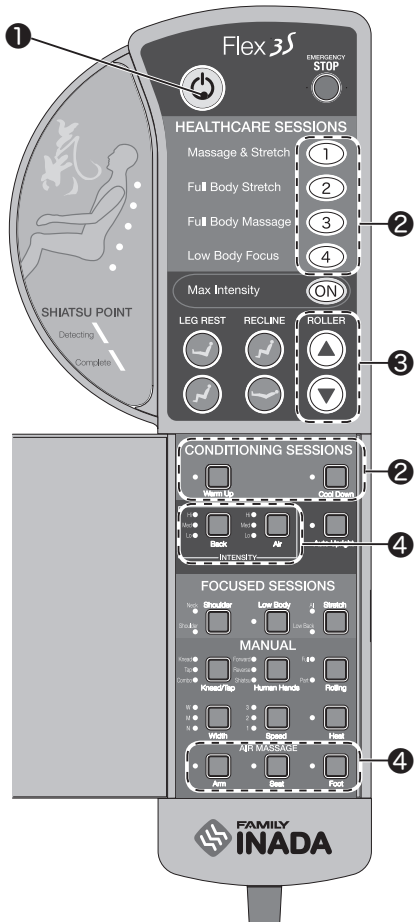

[PRESET SESSIONS]

1 Press the button.

If no session is made within 5 minutes, the power shuts off automatically.

2 Press the desired session button.

The chair will recline for a short time. Then, the shiatsu point locator indicator turns on and shiatsu point locating is performed.

[Note]

Sit as far back as possible in the chair and put your head against the headrest in a relaxed manner. Shiatsu points cannot be accurately located if you are not properly seated.

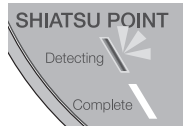

3 The shoulder positions can be adjusted.

After the shiatsu points are located, the ROLLER buttons flash. The shoulder positions can be adjusted while the buttons flash. If no adjustment is required, do not use these buttons.

Shoulder Position Adjustment

If the shoulder position is not correct, adjust the shoulder position while the ROLLER buttons are flashing.

	▲	The rollers move up while this button is pressed.
	▼	The rollers move down while this button is pressed.

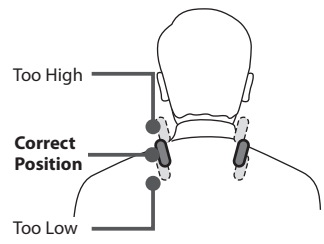

4 The session starts.

When shiatsu point locating is completed, the Complete light turns on and the session starts. During operation, you can adjust the mechanical intensity, adjust the air intensity or cancel the air operation.

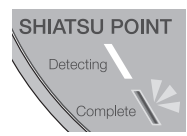





Mechanical Intensity Adjustment

The mechanical intensity can be adjusted in 3 levels. Each time the button is pressed, the intensity changes in the order of **Low, Medium and High**. (The default setting when the session starts is Medium.)



The intensity can be changed in the order of **Low, Medium and High** even when Max Intensity mode is ON. (The default setting when Max Intensity mode starts is High.)

Air Massage Intensity Adjustment and Cancellation

	<p>The air massage intensity can be adjusted.</p> <p>Each time the air intensity button is pressed, the intensity changes in the order of Low, Medium and High. (The default setting when the session starts is Medium.)</p> <p>In the same way, the intensity can be changed in the order of Low, Medium and High even when Max Intensity mode is ON. (The default setting when Max Intensity mode starts is High.)</p>
	<p>The arm air massage can be turned ON/OFF.</p> <p>Set the arm air massage operation during the session. Each time the button is pressed, the setting switches between ON/OFF.</p>
	<p>The lower back/seat air massage can be turned ON/OFF.</p> <p>Set the seat air massage operation during the session. Each time the button is pressed, the setting switches between ON/OFF.</p>
	<p>The leg air massage can be turned ON/OFF.</p> <p>Set the leg air massage operation during the session. Each time the button is pressed, the setting switches between ON/OFF.</p>

⑤ Session completed.

The reclining seat back automatically rises, and the rollers return to their storage position (upper part of the seat back). Then the power to the remote control is shut off. However, the reclining of the seat back and the up or down adjustment of the leg rest can still be operated.

Automatic Raise Cancel



The function in which the seat back automatically rises when the session is completed can be canceled. A green lamp lights while it is canceled. Press the button again to release the cancellation, and the seat back rises when the session is completed.

Changing Sessions

Before the session in progress finishes, you can change it to another session. After a total duration of 30 minutes, the session in progress stops even if not completed.

Switching from One Preset Session in Progress to Another

When one preset session button is pressed while another preset session is in progress, the rollers return to the detected shoulder positions, and the shoulder positions are rechecked before starting the massage again. The shoulder positions can be adjusted while the shoulder positions are being rechecked.

Switching from a Preset Session to Manual Session Mode

When one of the buttons for manual session mode located inside the panel of the remote control is pressed while a preset session is in progress, the preset session immediately stops, and the selected operation starts. If an operation that detects the shoulder positions is selected, the shoulder positions are rechecked before starting the operation. (To select an air massage, first select an operation such as kneading or tapping, or press the  button to stop the preset session in progress before making the session.)

Stopping in the Middle of a Massage

To stop mid-massage, press the  button. The rollers return to their storage positions and stop.

In an emergency or if there is some malfunction during the operation of the chair, press the EMERGENCY STOP button. The rollers will stop immediately. After confirming safety, press the  button. The rollers return to their storage positions and stop.

When a preset session is selected, the reclining seat back may recline automatically. In addition, during some sessions the reclining seat back moves automatically, so before using the chair, make sure that there is no person or obstruction behind it. Also, do not let other people approach the chair during use.



- If you feel the massage is too strong, reduce the stimulation according to this Operating Manual. If this solution does not work, stop operation immediately and contact the "Repair Service Center" (see back page) for assistance.
→ May result in injury if you continue use with high stimulation under such circumstances.
- Do not place your hands or feet into the roller tracks, into the space between the seat back and the seat or into the moving parts. Do not sit wearing hard objects, such as hair accessories, necklace, watch, bracelet, or ring.
- If your leg or foot comes out of the leg rest during the massage, do not try to force it back in.
- Keep message sessions to no more than 15 minutes in length. Do not exceed 5 minutes for an area-specific massage of any particular part of the body.
→ Continuous use for extended periods of time can result in over-stimulation, which could cause the opposite of the desired effect, or even injury. The total amount of time for a daily massage should be limited to about 30 minutes.

MANUAL SESSIONS

Description of Manual Session Operations

Select the massage operation of your choice from among menus ① to ④.



● A circle in the adjustment column means that the particular adjustment can be made in the course of that massage action.

● The width cannot be adjusted if an action for which width adjustment is not available is combined with rolling.





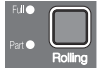



① Basic Operations

Button	Operation	Action	Speed Adjustment	Width Adjustment	Up/Down Adjustment	Intensity Adjustment
	Kneading	This performs a kneading type of massage.	○	—	○	○
	Tapping	This performs a tapping type of massage.	○	○	○	○
	Kneading & Tapping	Kneading and tapping are simultaneously performed.	○	—	○	○

② Rolling

Button	Operation	Action	Width Adjustment	Up/Down Adjustment	Intensity Adjustment
	Full 	This performs full stretching of the spine using up and down movements.	○	○	○
	Partial 	This performs partial stretching of the spine using up and down movements.	○	○	○

③ Special Operations

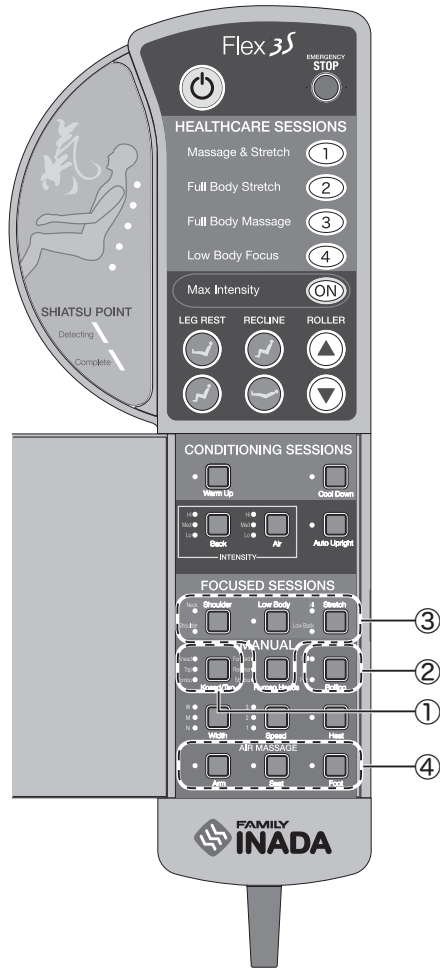

Button	Operation	Action	Speed Adjustment	Width Adjustment	Up/Down Adjustment	Intensity Adjustment
	Upward Kneading	This performs an upward kneading operation to the neck.	—	—	○	○
	Downward Kneading	This performs a downward kneading operation to the neck.	—	—	○	○
	Shiatsu	Performs shiatsu massage.	—	—	○	○
	Neck/Shoulder Top 	This performs a stretching operation from the neck to the shoulder top.	—	—	—	○
	Shoulder Massage 	This performs a kneading massage centered on the shoulders.	—	—	—	○
	Lower Back Stretching 	This performs a stretching operation on the lower back.	—	—	—	○
	Full-Body Bending 	This performs a bending operation to the entire body.	—	—	—	○
	Posture Straightening 	This performs a posture straightening operation.	—	—	—	○

 Indicates operations that locate Shiatsu Points (SP).



④ Air Massage

Press the button for the area that you want to massage.

Button	Operation	Action	Intensity Adjustment
	Arm Air	An air massage from your shoulders to fingers.	○
	Seat Air	An air massage from your lower back to buttocks.	○
	Leg Air	An air massage from your calves to toes.	○

MANUAL SESSIONS

Operation of Parts and Position Adjustment

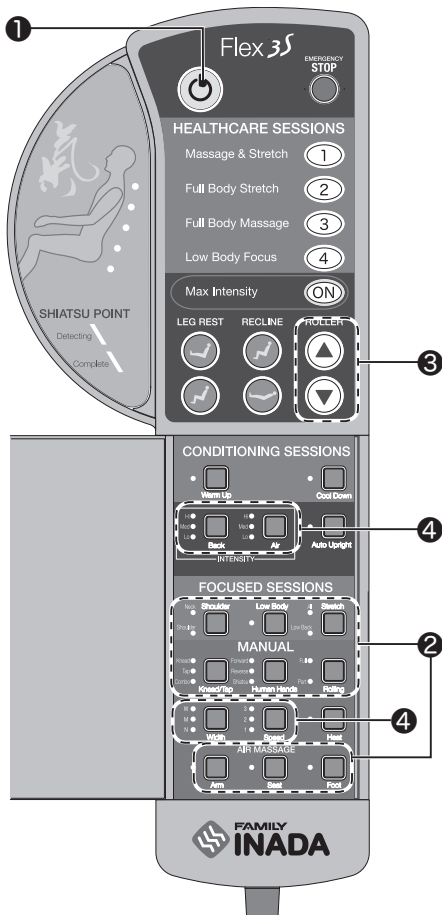

1 Press the button.

If no session is made within 5 minutes, the power shuts off automatically.

2 Press the button for the desired massage.

Select a combination of your operations of choice from basic operations, rolling, special operations and air massage.

3 The shoulder positions can be adjusted.

If an operation is selected that includes shiatsu point locating, the ROLLER buttons flash after the shiatsu points are located.

The shoulder positions can be adjusted while the buttons flash.

If no adjustment is required, do not use these buttons.



4 The session starts.

If an operation is selected that includes shiatsu point locating, when shiatsu point locating is completed, the Complete light turns on and the session starts.

A basic operation can be changed and the mechanical intensity or air intensity can be adjusted or canceled even while a session is operating.

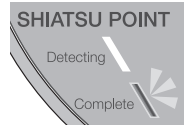

5 Session completed.

When the massage session finishes, the rollers return to their storage positions (upper part of the seat back). Then the power to the remote control is shut off. However, the reclining of the seat back and the up or down adjustment of the leg rest can still be operated.

[MANUAL SESSIONS]

Roller Position Adjustment

	When rolling is not selected: The roller position can be adjusted to the area that you want to massage.	The rollers move up while this button is pressed.
		The rollers move down while this button is pressed.
	When full rolling is selected: Changes between up and down.	When pressed during a down movement, changes to up.
		When pressed during an up movement, changes to down.
	When partial rolling is selected: The center position of the range of partial rolling can be adjusted. The position at which you release the button becomes the center of the operation.	The rollers move up while this button is pressed.
		The rollers move down while this button is pressed.

● When up (or down) is selected when the roller is already at the highest (or lowest) position or in the shoulder position where the shiatsu points were located, a warning alarm sounds.

Caution!

● If neither a basic operation nor rolling has been selected, there will be no operation even if you press a ROLLER button.

Width Adjustment



During a basic operation where width adjustment is possible, the width of the rollers can be adjusted in 3 steps (**Narrow, Medium and Wide**).

Speed Adjustment



During a basic operation where speed adjustment is possible, the speed of action can be adjusted in 3 steps.

Mechanical Intensity Adjustment



The mechanical intensity can be adjusted in 3 levels.

Each time the button is pressed, the intensity changes in the order of **Low, Medium and High**.

(The default setting when the session starts is Medium.)

 The intensity can be changed in the order of **Low, Medium and High** even when Max Intensity mode is ON.
(The default setting when Max Intensity mode starts is High.)

Intensity Adjustment of Air Massage



The air massage intensity can be adjusted.

Each time the air intensity adjustment button is pressed, the intensity changes in the order of **Low, Medium and High**.

(The default setting when the session starts is Medium.)

 The intensity can be changed in the order of **Low, Medium and High** even when Max Intensity mode is ON.
(The default setting when Max Intensity mode starts is High.)

Changing Sessions

Switching from Manual Session Mode to a Preset Session

When another preset session button is pressed while a manual session is in progress, the operation changes to the preset session. After a total duration of 30 minutes, the session in progress stops even if not completed.

Stopping in the Middle of a Massage

To stop mid-massage, press the  button. The rollers return to their storage positions and stop.

In an emergency or if there is some malfunction during the operation of the chair, press the EMERGENCY STOP button. The rollers will stop immediately. After confirming safety, press the  button. The rollers return to their storage positions and stop.

Caution

● If you feel the massage is too strong, reduce the stimulation according to this Operating Manual. If this solution does not work, stop operation immediately and contact the "Repair Service Center" (see back page) for assistance.

→ May result in injury if you continue use with high stimulation under such circumstances.

● Do not place your hands or feet into the roller tracks, into the space between the seat back and the seat or into the moving parts.

Do not sit wearing hard objects, such as hair accessories, necklace, watch, bracelet, or ring.

● If your leg or foot comes out of the leg rest during the massage, do not try to force it back in.

● Keep message sessions to no more than 15 minutes in length. Do not exceed 5 minutes for an area-specific massage of any particular part of the body.

→ Continuous use for extended periods of time can result in over-stimulation, which could cause the opposite of the desired effect, or even injury.

The total amount of time for a daily massage should be limited to about 30 minutes.

How To Use Max Intensity Mode



What is Max Intensity Mode?

This function performs changes other than adjusting the mechanical intensity and air intensity to make the massage even more intense.

Max Intensity



① Select Max Intensity mode during a massage.

The chair enters Max Intensity mode and the mechanical intensity and air intensity are set to High.

② Adjust the strength.

To adjust the intensity, press the intensity adjustment buttons.

③ Cancel Max Intensity mode.



When Max Intensity mode is canceled, the mechanical intensity and air intensity remain at the intensity level at the time of cancelation.



*This mode is for an intense massage, but some people may not feel that the massage is particularly intense. This is because sensitivity varies according to the individual, and is not a malfunction.

TROUBLESHOOTING

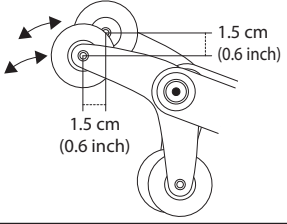
If there is still a problem after trying the solutions given in this troubleshooting guide, stop using the chair immediately to prevent accident or injury, and unplug the power plug from the wall outlet. Contact your local Inada distributor (see back page) for assistance.

Problem	Cause & Solution	
<p>The right and left rollers are out of alignment.</p>	<p>The rollers are designed with an alternating tapping mechanism, so in the stopped position they are sometimes out of line. This is part of the design and is not a malfunction.</p> 	<p>This is part of the design and is not a malfunction.</p>
<p>The rollers moved up to the top and then stopped.</p>	<p>The auto timer will cause the rollers to move up to the top of the chair when the massage time is finished, so as not to interfere with your movements when getting out of the chair.</p>	
<p>The rollers stop during the massage.</p>	<p>Sometimes when there is too much pressure to the rollers, they can stop moving temporarily. Slightly lift your body or lightly raise the reclining seat back. (Be especially careful when a person who weighs 100 kg (220 lb) or more uses this chair.)</p>	
<p>The  button of the remote control and the session button flash.</p>	<p>Set the main POWER switch located at the front right of the chair to OFF, and then back ON after about 5 seconds.</p>	<p>If there is still a problem after the check, stop using the product immediately.</p>
<p>The automatic shiatsu point locator function is not working properly. <small>(The height of the rollers does not match the shoulders.)</small></p>	<p>Sit further back in the chair so that your head rests firmly on the headrest. You can adjust the shoulder position with the ROLLER buttons immediately after the shiatsu points are located.</p>	
<p>Remote control buttons do not seem to be operating normally. Or the power does not turn on.</p>	<p>Check for the following:</p> <ol style="list-style-type: none"> ① Is the power cord fully plugged into the wall outlet? ② Is the power switch located on the right side of the chair set to ON? ③ Are you pressing two buttons at the same time? 	
<p>The power cord or plug is abnormally hot.</p>	<p>Stop using immediately.</p>	
<p>For details, contact your local Inada distributor.</p>		
<p>Anyone other than an authorized serviceperson must not repair or disassemble.</p>		

[TROUBLESHOOTING]

Noise during chair operation

These noises are a normal part of the chair's operation and do not affect its performance in any way.

The following noises are made during operation.

Noises during tapping
Sound of the rollers rubbing against the seat cover during kneading
Sound of raising and lowering the rollers, sound of roller operations
Sound of the air massage cushions
Sound of the air pump
Sound of air discharge
Sound of raising and lowering the reclining seat back

REGULAR MAINTENANCE FOR SAFETY

Regular Maintenance Will Preserve the Life of Your Chair

Have you experienced any of these problems?

- The chair does not start with the main POWER switch set to ON.
- The power cord has been cracked or scratched.
- The power cord or plug becomes abnormally hot.
- The chair produces a burnt smell, abnormal sound or vibration.
- The auto timer function does not work in some cases.
- Other failures.

If you find anything listed on the left, stop using and unplug the power cord from the outlet to prevent failure or an accident. Be sure to contact your local Inada distributor for maintenance.

To use safely

The chair fabric (roller fabric) is a consumable part, and its service life is 3 years (conditions of use: two 15-minute sessions a day, every day). For safe use, periodic inspection by your local Inada distributor is recommended before the end of the service life.

*Durable years vary depending on conditions of use.

*After about 5 years of use, a professional inspection is recommended even if there are no symptoms or problems.

For inspection fees, contact your local Inada distributor.

Q Can I put the chair onto a wooden floor or a heated floor?

A Yes.

However, because the chair could damage the floor surface, we recommend laying a carpet or something similar under the chair. (Same applies to other floor surfaces)

Q Can I use the chair even if I am overweight?

A We recommend the chair be used by people weighing less than 100 kg.

If you weigh more than that, try sitting slightly up in the chair, and not reclining too far.

Q How do I make the massage stronger?

A Perform the following:

- Sit back further in the chair so that your weight is against the reclining seat back.
- Lower the reclining seat back.
- Remove the buffer pad placed on the back pad.

With the methods above, you can intensify the massage.

Q Can the reclining seat back raise be stopped when a session is completed?

A Yes. It can.

You can stop the automatic reclining seat back raise operation from operating when the session is completed by pressing the "Auto Upright" button.

Q How do I make the massage lighter?

A Perform the following:

- Raise the reclining seat back.
- Place the buffer pad on the back pad.
- Remove the shiatsu pad and shiatsu sheet.
(When installed)

With the methods above, you can make the massage more gentle.

Q Can someone who is under 150 cm (5 feet) or over 180 cm (6 feet) use the chair?

A Yes.

Because the correct shoulder positions may not be found during shiatsu point locating, we recommend using the chair as follows.

- Short person: Raise the reclining seat back.
- Tall person: Recline the reclining seat back.
- After shiatsu point locating is performed, adjust the shoulder positions.

Q I spilled water on the chair. What should I do?

A There is a danger of an electric shock. Immediately stop using the chair and perform the following.

- Turn off the main POWER switch on the front right of the chair.
- Unplug the power plug from the wall outlet.

After performing the above, contact the your local Inada distributor for assistance.

Q The remote control panel has come off. Can I fix it?

A Reattach with the following procedure.

- ① Hold the remote control as illustrated, and insert the projection on the bottom left of the panel into the hole on the remote control.

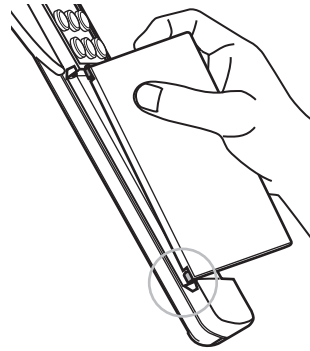

- ② Lightly push the panel in the direction of the arrow and insert the projection on the top left of the panel into the hole on the remote control.

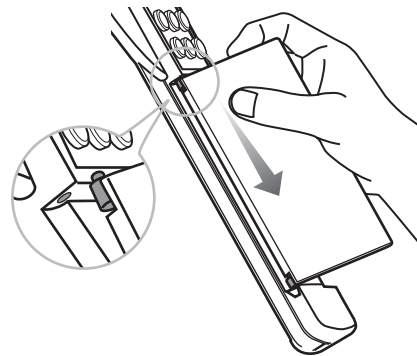

CARE AND STORAGE

Storage

- After wiping off any dust or dirt, store your chair in a place that is relatively dry.
- If the chair is left unused for a while, put a cover on it that will protect it from dust and dirt.
- Pets can sometimes chew on power cords, so try to keep pets away from the chair even when it is being stored.



Caution

- Do not install the chair where it can come into contact with direct heat, such as direct sunlight or a radiator.

Care and Maintenance



Caution

- When cleaning the chair, be sure to unplug the power plug from the wall outlet first. Do not plug or unplug the power plug with wet hands.

[Caring for the Back Pad and Covers]

Soak a piece of soft cloth in lukewarm water in which a small amount of mild detergent has been added. Then thoroughly wring it out before cleaning off any spots or grime.



Caution

- The fabric color can change if the chair is in contact with vinyl covers or wall coverings for a prolonged period of time.

[Caring for the Remote Control]

Wipe dirt off the remote control with a dry cloth.

- Never use a moistened or wet cloth. → May result in a mechanical failure.

[Caring for Other Plastic Parts]

Soak a piece of soft cloth in lukewarm water in which a small amount of mild detergent has been added, thoroughly wring it out, and clean off any spots or grime. Then wipe with a dry cloth so that no detergent residue remains.

- Do not use alcohol-based or other household cleaning products or abrasives because they can scratch or crack the finish or cause color to fade.

AFTER SALES SERVICE

1. Warranty

Please read the contents carefully and keep it in a safe place. Please complete and mail in the warranty card that was included with your chair.

If the chair is to be used outside the home (in a commercial setting, for example), fees will be charged for repairs.

2. Repairs & Service

Before calling for repairs or service, use the Troubleshooting guide on pages 23-24 to see if the problem can be solved easily.

If the problem persists, contact your local Inada distributor for assistance. Have the following information ready.

- 1) Your name, address, and phone number
- 2) Product name and model number (see the Back Cover)
- 3) Serial No. (see the Serial No. label on the Back Cover)
- 4) Date of purchase
- 5) Trouble status
- 6) Proof of purchase

● **If the warranty is valid:**

A service charge may apply, subject to the nature of the trouble and/or repair according to the terms of the warranty. See the warranty for full details.

● **If the warranty has expired:**

See the back of this booklet and contact your local Inada distributor.

If the product can be repaired, we will give you an estimate of the cost to repair the product.

● **Replacement parts stock:**

We will stock service parts (except fabric) of this product for at least six years after terminating the production of this model. Service parts refer to those necessary for maintaining the intended performance of the product.

● **For more information on service:**

Please see the back page of this booklet.

SPECIFICATIONS

Name & Model Number		HCP-S373A	
Power Supply		AC120V~	
Power Consumption		150W	
Power Frequency		60Hz	
Rated Time		30 minutes	
Upper Body	Kneading Speed	3 levels, from minimum 6 times/minute to maximum 20 times/minute (approx.)	
	Tapping Speed	3 levels, from minimum 180 times/minute to maximum 500 times/minute (approx.)	
	Roller Width	3 steps (narrow, medium and wide)	
	Up/Down Speed	One full cycle in approx. 26 seconds (minimum approx. 3.1 cm (1.24 inch)/sec, maximum approx. 4.2 cm (1.68 inch)/seconds)	
	Back Stroke Range	Approx. 69 cm (27.6 inch) (in partial roller massage: approx. 15 cm (6 inch))	
Preset Sessions		Healthcare sessions: 4 types	Conditioning sessions: 2 types
Focused Sessions/ Manual Sessions		16 types (automatic shiatsu point locator function included in some sessions)	
Air Pressure		Approx. 37 kPa	
Auto Timer		Approx. 15 minutes (preset sessions vary in duration)	
Leg Rest Adjustment Range		Approx. 27cm (10.6 inch)	
Reclining Angle		Approx. 115° - 165° from floor level, continuous motion (Automatic reclining)	
Chair Dimensions		Approx. 83 × 133 (195) × 106 (73) cm (W/D/H) (Approx. 33 × 53 (77) × 42 (29) inch (W/D/H)) The depth and height figures in () represent the dimensions when fully reclined and with the leg rest flat.	
Weight		Approx. 75 kg (165 lb)	
Outer Covering		Synthetic leather	
Supplied Items		AC cord, buffer pad, shiatsu ball ×2, remote control pocket, T-shaped wrench	

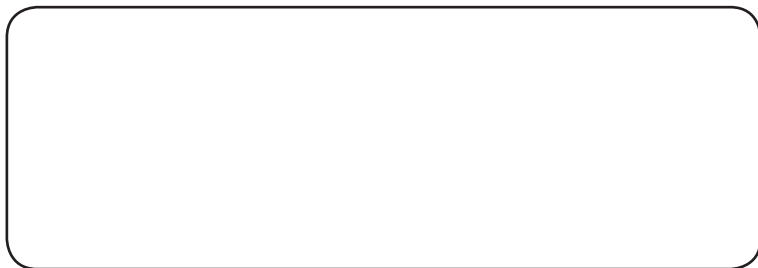

Manufactured by FAMILY INADA CO., LTD.
2-1-3 Nishi-Miyahara, Yodogawa-ku, Osaka 532-0004, Japan

DATE OF ISSUE(day/mo/yr)
1/2/2014
Made in JAPAN

778575900