

Limited Warranty

SOL-1015 Solace Massage Lounger

Consumer Limited Warranty: ONE-YEAR WARRANTY

This warranty guarantees that the product purchased is to be free from defects in material and workmanship under normal usage and local voltage for a period of one year. This warranty expires in TWO (2) years on parts, and ONE (1) year on labor after the date of purchase.

U.S. Jaclean, Inc. (referred to as "the Warrantor") will repair this product with new or rebuilt parts in case of defects in material or workmanship, free of charge, in the USA provided that:

- 1) The product is operated in accordance with the printed instructions supplied.
- 2) The product is used under normal conditions for which designed.
- 3) The product is not subjected to misuse, negligence, or accident.
- 4) The product receives proper care, protection, and maintenance.

This warranty is extended to the original end-user when purchased from an authorized U.S. Jaclean, Inc. distributor. A purchase receipt or other proof of date of the original purchase is required for service and parts replacement under this warranty. This warranty does not cover shipping charges for defective items if a claim is made more than 30 days after the date of purchase.

This warranty only covers failures due to defects in materials and workmanship, and does not cover normal wear or cosmetic damages. This warranty does not cover damages which occur in shipment, or failures which result from: accident, misuse (including, without limitation, failure to comply with instructions and use limitations contained in the Operating Instructions), abuse, neglect, mishandling, faulty installation, set-up adjustments, improper operation or maintenance, alteration, modification, power line surge, lightening, improper line voltage, commercial use such as hotel, office, restaurant, or other business or rental use of product, service by anyone other than from U.S. Jaclean, Inc., or damage that is attributable to "acts of God." Continued use of this product after discovering a defect voids this warranty. This warranty gives you specific legal rights, and you may also have other rights which may vary from state to state.

**IMPORTANT: DO NOT return defective product to the store.
Contact U.S. Jaclean, Inc. for repair services.**

Please retain this Warranty Certificate, together with the original purchase receipt, and present it to our technician for inspection during service.
For assistance and more information, please contact U.S. Jaclean, Inc.

Online warranty registration at: daiwamassage.com

Daiwa
RELAX LIKE ROYALTY

SOLACE

MASSAGE LOUNGER

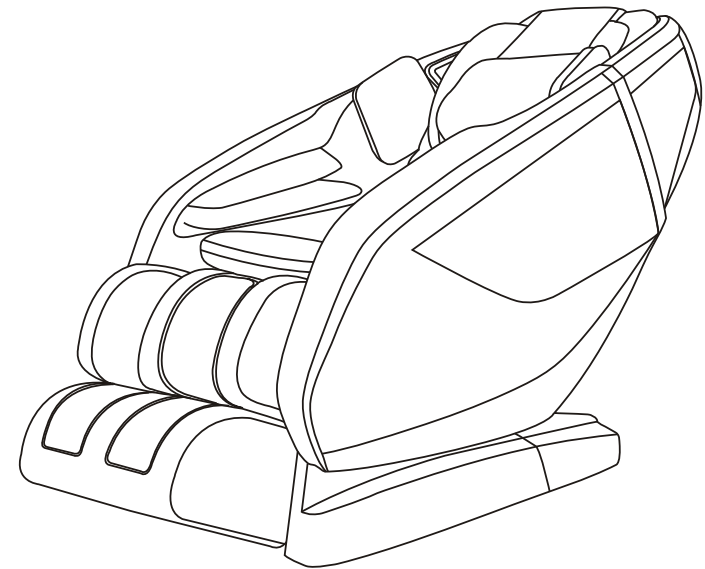

MASSAGE LOUNGER

Before operating this unit, please read these instructions completely.

* Due to continuous quality improvement, the specifications and part names in this instruction manual may be different than the actual product

Daiwa
RELAX LIKE ROYALTY

Distributed by U.S. Jaclean, Inc.
1816 West 135th Street
Gardena, CA 90249

1-833-542-1918
9AM - 5PM PST (Monday - Friday)
daiwamassage.com

Operating Instructions

SOL-1015

SOLACE

Thank you for purchasing the Solace Massage Chair.

Before using this chair for the first time, please read through all sections of this User Manual carefully, paying special attention to the Safety Instructions.

PLEASE RETAIN THIS MANUAL FOR FUTURE REFERENCE.

CONTENTS

IMPORTANT SAFETY INSTRUCTIONS	1
PARTS	3
Exterior Parts.....	3
Interior Parts	3
Power Supply Box	4
Main Controller.....	5
OPERATION	5
Controller Operation	6
Automatic Programs.....	7
Manual Programs	8
SETUP	13
Installation.....	13
Initial Operation.....	15
Moving the Chair.....	16
Massage Chair Placement	17
Grounding Instructions	18
PRODUCT STORAGE AND MAINTENANCE	19
TROUBLE SHOOTING	20
TECHNICAL SPECIFICATIONS	20

▶ TROUBLE SHOOTING

No.	Problem	Check the following:	Explanations / Remedies
1	Noises are heard during operation	N/A	These noises are normal and arise from friction between the massage rollers and the leather cover.
2	Operation fails to start	Has the power plug slipped out of the wall outlet? Is the power switch in the "off" position? Has the fuse blown out?	Connect the power plug securely to the wall outlet. Switch power to the "on" position. Replace the fuse with another of the same type.
3	Airbags within the seat and the legrests fail to work properly	Are the air tubes blocked?	Clean out the air tubes.
4	Airbags within the seat and the legrests fail to work properly	The massage chair has detected some error that it is unable to display.	Turn off power, then turn it on again. If the problem persists, disconnect the power plug from the wall outlet and contact an authorized repairman

If you encounter problems operating the Solace, please check the points above to see if they can be rectified. If the Solace still malfunctions or does not work, please turn off the chair and remove the power plug from the electrical outlet. Contact U.S. Jaclean Repair Service at 310-538-2298 for assistance.

IMPORTANT

Do not dismantle or attempt to repair the chair yourself. Doing so will void the warranty and U.S. Jaclean/Daiwa will not bear any responsibility for any subsequent consequences.

▶ TECHNICAL SPECIFICATIONS

Product name: Solace
 Product Model: SOL-1015
 Rated voltage: 110-120 V~
 Rated frequency: 60 Hz
 Rated power: 1.1 A
 Safety design: Class I

▶ IMPORTANT SAFETY PRECAUTIONS

- ▶ Basic precautions should always be followed when using an electrical unit, including the following.
- ▶ Please ensure that you read all instructions before using the Solace.

 **DANGER** – To reduce the risk of electric shock:

1. Always unplug this unit from the electrical outlet immediately after using and before cleaning.

 **WARNING** – To reduce the risk of burns, fire, electric shock, or injury to persons:

1. Always insert the power plug all the way into the outlet to reduce the risk of short-circuit and fire.
2. The unit should never be left unattended when plugged in. Always unplug the unit when not in use.
3. The unit is not to be used by people who cannot move or communicate on their own.
4. Only use the unit for the purpose described in these instructions.
5. Do not stand on the unit.
6. Always return the seat to the upright position and make sure the legrest is completely retracted. Be careful that nothing is obstructing the legrest while retracting. Keep children away from the legrest.
7. Never operate the unit if it has a damaged power cord or plug. Return the unit to the nearest authorized service center if it is not working properly, if it has been dropped or damaged, or if it has been immersed in water.
8. Keep power cords away from heated surfaces. Do not carry the unit by the power cord.
9. Never block the air openings during operation and make sure that all air openings are kept free of lint and hair, etc. Do not drop or insert anything into any of the openings of the unit.
10. Do not use the unit on top of heating appliances, such as electric carpets, etc. Do not operate the unit under a blanket or pillow. Excessive heating can occur and cause fire, electric shock, or injury to persons.
11. Do not use the unit in bathrooms or other damp or humid places as this may cause electric shock or cause the unit to malfunction. Do not spill water, etc. onto the controller.
12. Do not use the unit outdoors.
13. Do not use or operate where aerosol spray products are being used or where oxygen is being administered.
14. When unplugging the unit, turn off all controls before removing the plug from power outlet. Do not use the unit with a transformer as this may lead to malfunction or electric shock.
15. Connect this unit to a properly grounded outlet only. See Grounding Instructions.
16. Use heated surfaces carefully. May cause serious burns. Do not use over insulative skin areas or in the presence of poor circulation. The unattended use of heat by children or incapacitated persons may be dangerous.

SAVE THESE INSTRUCTIONS

▶ IMPORTANT SAFETY PRECAUTIONS

- Persons with any of the conditions listed below or who are undergoing medical treatment or suffer from medical conditions should consult with their physicians before using the unit:
 - Pregnant women, people who are ill, in poor physical shape.
 - People suffering from back, neck, shoulder, or hip pain.
 - People who have a pacemaker, defibrillator, or other personal medical devices prone to electronic interference.
 - People suffering from heart disease.
 - People who are prohibited from receiving massage by a physician due to thrombosis or aneurysm, acute varicose veins, or other circulatory disorders.
 - People with irregular curvatures of the spine.
 - People who have a loss of heat sensation.
- This unit should not be used by children.
- Sit down slowly after checking the position of the massage heads. Never put any part of your body between the massage heads as the squeezing action of the massage heads may cause injury. Never put your fingers or feet in the gap between the backrest and seat, the backrest and the armrest, the seat and cover under the armrest, or the gap between the legrest and the footrest. Do not place your fingers or any part of your body in the mechanism below the legrest, or between the legrest and footrest.
- Do not use the unit against bare skin. While thin clothing may increase effectiveness, exposing the skin directly to the massager may irritate the skin. Do not use the unit while wearing anything hard on your head like a hair accessory, etc. Do not use the unit for massaging the head, abdomen, front neck, elbows or knees. Do not use excessively strong massage action on the back of the neck.
- When using the body scanning function, always ensure that the shoulder position is correct. If the shoulder position is not correct, use the POSITION button to adjust it properly. Or stop the massage function and re-try the body scanning function. You can adjust the shoulder position in this way in the auto program and manual operation. Failure to align the shoulder position correctly can lead to injury.
- While using the massager, if the pressure seems too strong, the movement of the massage heads can be stopped at any time by pressing the Stop button.
- Do not go to sleep while using the massage function.
- Do not use the unit after drinking alcohol.
- When the seat back is in a reclined position, do not sit on it or sit with your legs resting on the headrest. Do not sit on the legrest as the unit may fall over.
- Do not allow children or pets to play on or around the unit, especially during operation.
- Do not unplug the unit or turn it off during operation. Unplug the unit immediately if there is a power outage.
- Do not allow children to play on this mechanized furniture or operate the mechanism. Legrest folds down on closing so that a child could possibly be injured.
- Always leave in an upright and closed position.
- Keep hands and feet clear of mechanism. Only the occupant should operate it.
- Remove hard objects, such as false fingernails, wristwatches or rings, when massaging hands or arms. Empty pockets of hard objects when massaging the area of the seat or thighs.
- When "Heat" massage heads are used, do not let the massage heads touch the same place for a long time. Low-temperature burn may occur.

▶ PRODUCT STORAGE AND MAINTENANCE

CLEANING

- ▶ Before cleaning, switch off power and remove the power plug from the wall outlet.
- ▶ Dip a soft, cotton cloth in neutral detergent and wring dry. Use it to wipe the pillow cushion, back cushion, armrests, legrests, and any plastic parts of the chair.
- ▶ Use a piece of wet cloth (without detergent) to re-wipe the pillow cushion and back cushion. Place them in a well-ventilated location for drying.
- ▶ Use a soft, dry cloth to re-wipe the armrests, legrests, and any plastic parts of the chair.
- ▶ Use a soft, dry cloth to wipe the controller, the DVD player, and the power supply box.

CAUTION

- ▶ Before any maintenance, always disconnect the power plug from the wall outlet.
- ▶ To avoid electric shock, never touch the power plug with wet hands.
- ▶ When cleaning the back cover of the massage chair, do not allow any detergent to seep into the power supply box.
- ▶ Do not use abrasive chemicals, such as benzene or alcohol, to clean this chair.
- ▶ Damage to the chair may result.
- ▶ DO NOT apply an iron or any other heated device to the chair.

STORAGE

- ▶ Before putting into storage, wipe off all accumulated dirt and dust from the surface of the chair. Cover the entire surface of the chair with a dust cover (not included).

CAUTION

- ▶ Do not store the product under direct sunlight, nor in a location with high temperatures. Doing so may cause the upholstery to fade.

MAINTENANCE

Upon detecting any of the following conditions during daily use, immediately turn off power, disconnect the power plug from the wall outlet, and contact an authorized repairman:

- ▶ A burning smell
- ▶ The cord is plugged in and the power switch flipped on, but no functions operate.
- ▶ The power cord feels hot.
- ▶ Any other abnormal symptoms

CAUTION

- ▶ Do not store the product under direct sunlight, nor in a location with high temperatures. Doing so may cause the upholstery to fade.

▶ SETUP

GROUNDING INSTRUCTIONS

This product must be grounded in the event of an electrical malfunction. Grounding provides a low resistance path for the electric current to reduce the risk of electric shock. The cord is equipped with a built-in equipment-grounding conductor and a 3-prong grounding plug. This plug must be used with an appropriate outlet installed and grounded in accordance with all local codes and ordinances.

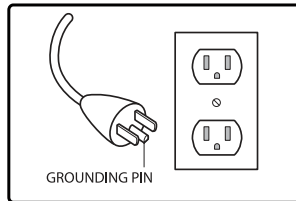

⚠ DANGER

- ▶ Improper connection of the equipment-grounding conductor can result in a risk of electric shock. Check with a qualified electrician or serviceman if you are in doubt as to whether the product is properly grounded. Do not modify the plug provided with the product – if it will not fit the outlet, have a proper outlet installed by a qualified electrician.
- ▶ This product is for use on a nominal 120-volt circuit and has a grounding plug that looks like the plug illustrated. Make sure that the product is connected to an outlet having the same configuration as the plug. No adapter should be used with this product.

GROUNDING

This massage chair belongs to Class I of the IEC Protection Class. Be sure to use a three-core power supply socket. To avoid electric shock, leakage, or other electric risk, ensure the ground wire connected to the power supply has obtained a stable ground connection.

▶ PARTS

EXTERIOR STRUCTURE

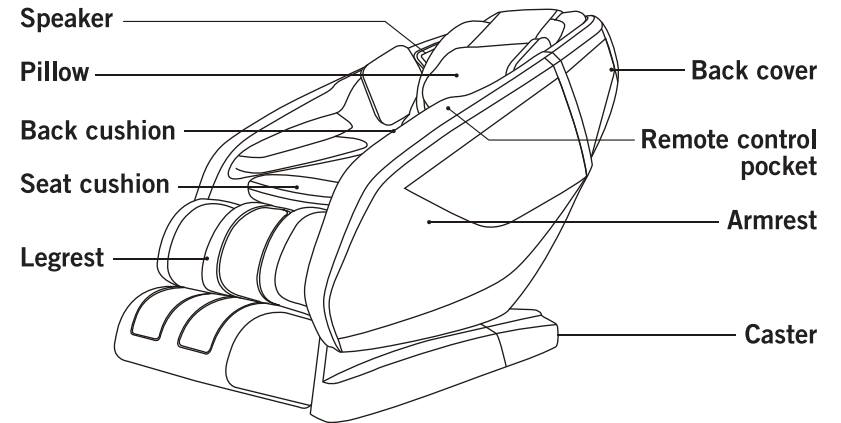

INTERIOR STRUCTURE

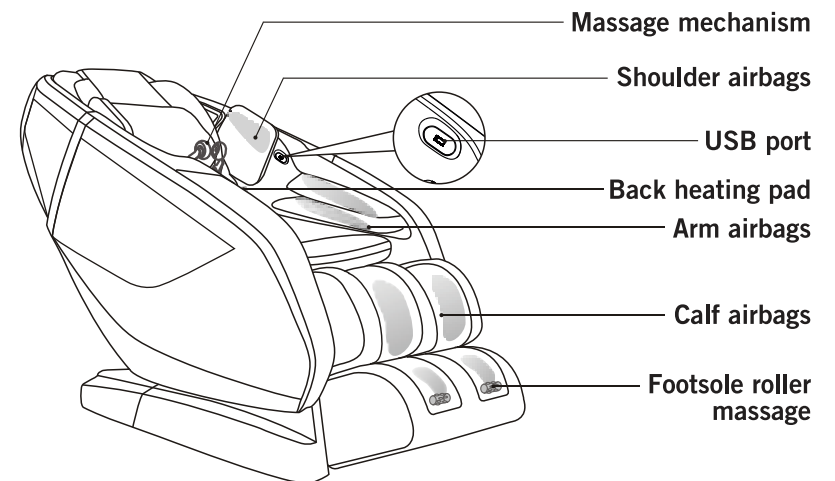

▶ PARTS

POWER SUPPLY BOX

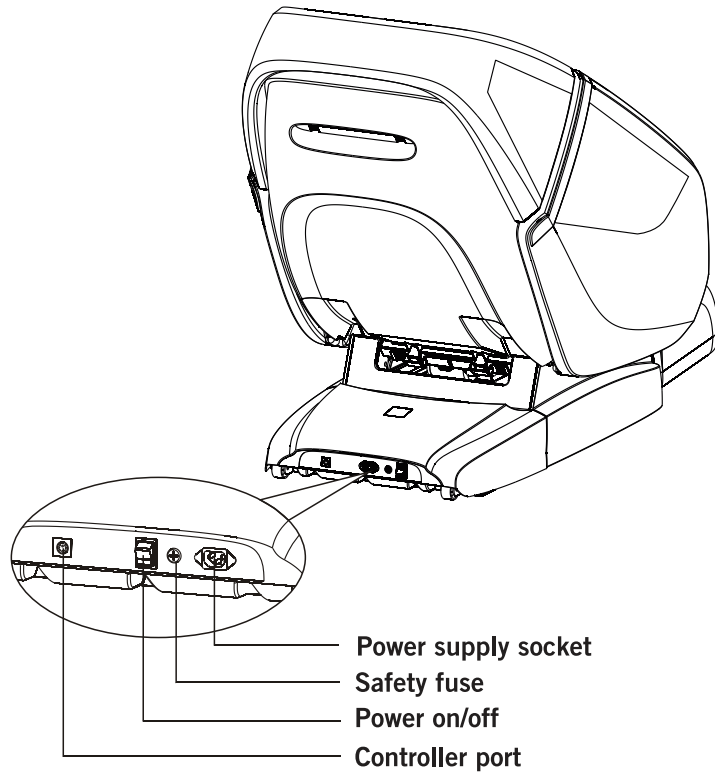

▶ SETUP

MASSAGE CHAIR PLACEMENT

When looking for a location to place your massage chair, keep following in mind:

- ▶ The chair takes up significantly more space when stretched out, than when in an upright position. With the chair upright, allow at least 3 inches of open space behind the backrest, and at least 19 inches of space in front of the footrest.
- ▶ To prevent wearing out the floor beneath the chair, we advise placing some cushioning material, such as a rug or plastic mat, underneath the chair.
- ▶ To prevent possible electrical leakage, do not place the massage chair in or near a damp environment, such as a bathroom.
- ▶ To prevent fire or damage to its leather material, keep the massage chair away from any sources of heat (such as a stove or furnace).

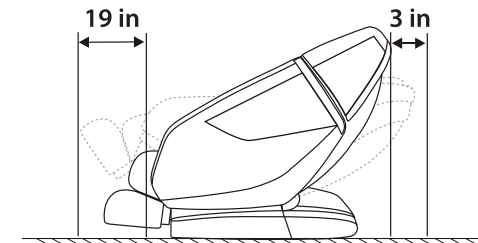

WHERE TO USE THE UNIT

- ▶ Ensure adequate space to recline.
- ▶ Do not expose the massage lounger to direct sunlight or high temperatures, such as in front of heating sources, because this can cause discoloration or hardening of the synthetic leather.
- ▶ Place the unit on a mat to prevent floor damage.
- ▶ When placing a mat under the unit, The size of the mat should be sufficient [At least 48 in. × 72 In. (122 cm × 183 cm)] to cover the areas where the unit touches and where the leg rest could touch the floor, as shown in the diagram on the right.
- ▶ Install the unit near a power socket.

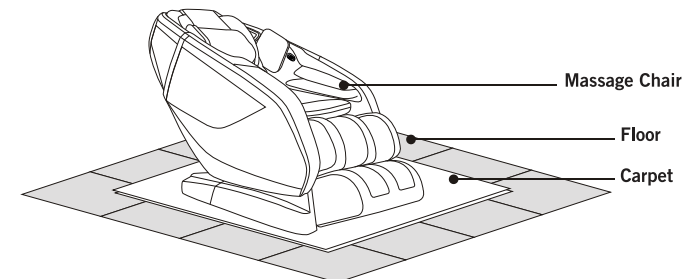

▶ SETUP

MOVE METHOD

- ▶ Make sure that the backrest is in its highest upright position.
- ▶ Shut off power and remove the power plug from the wall outlet.
- ▶ Standing behind the back of the chair, grasp its backrest and tilt it downward, so that the front of the chair rises off of the floor. Push the chair to the location you desire.

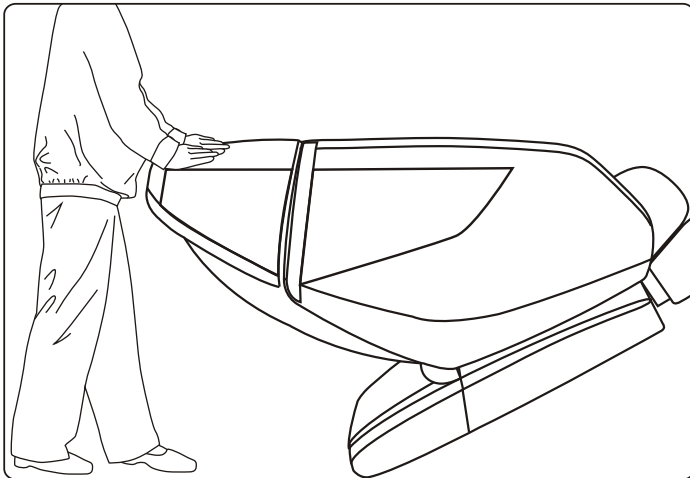

⚠ CAUTION

- ▶ Do not attempt to move the chair while someone is still sitting on it.
- ▶ While moving the chair, always grasp its backrest. No not try to move the chair by grasping its armrests.
- ▶ Before plugging it in, inspect the entire power cord and plug for any possible damage. Make sure that no electrical wires are exposed.
- ▶ Make sure that the power supply switch is turned OFF before inserting the power plug into a wall outlet.

▶ PARTS

MAIN CONTROLLER

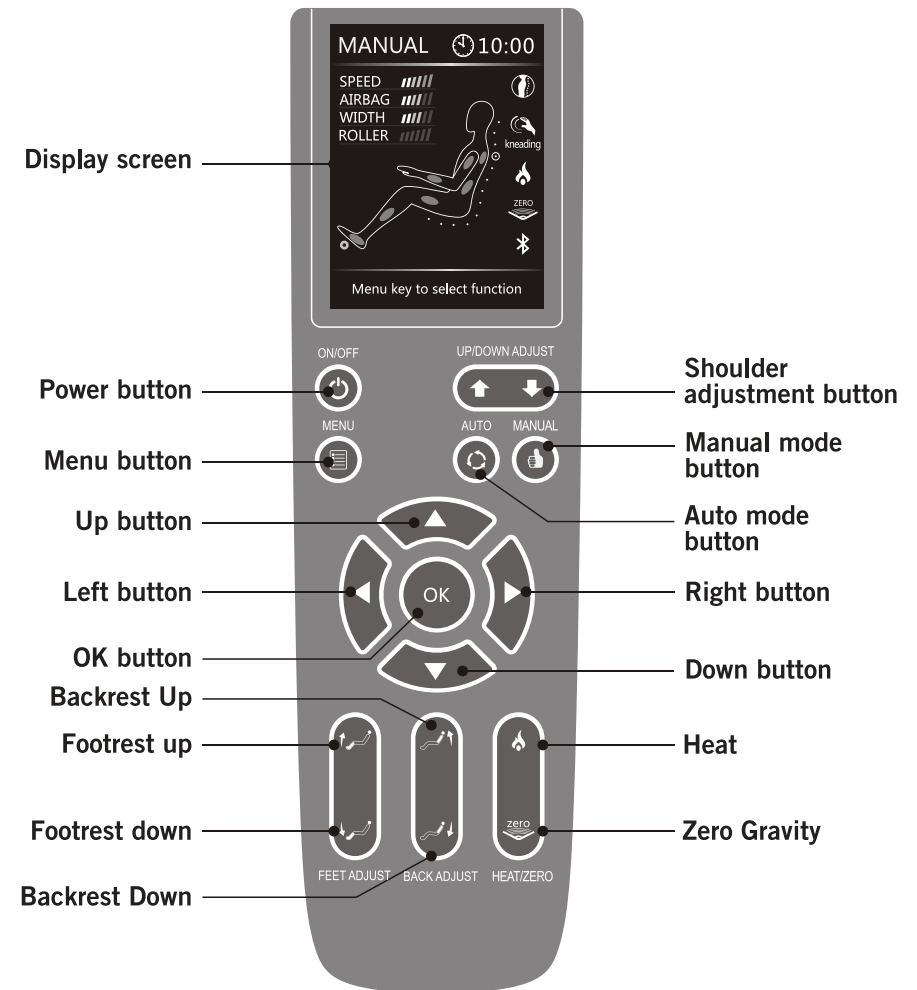

▶ OPERATION

CONTROLLER OPERATION

Power Button

- ▶ Press to turn on the unit. The display screen will light up. Press the Up or Down key to highlight your preferred massage mode and preference. Press the center OK button to select.
- ▶ Press again to turn off all functions. The default running time is 20 minutes for each massage.

Menu Button

During any massage operation, press here to:

1. Select and switch to a direct massage function
2. Add or end an option to run with your current massage program

Shoulder Position Adjustment keys

- ▶ While the Point mode manual program is running, use these keys to adjust your desired position of the point massage.

Auto mode button

- ▶ Press this button to bring up the chair's six automatic massage programs.

Manual mode button

- ▶ Press this button to bring up the chair's six automatic massage programs.

Direction Dial

- ▶ After pressing the Menu or Auto mode buttons, use the Up, Down, Left, or Right direction keys to move among selections. Then press the center OK key to confirm that selection
- ▶ During the massage, press the Up, Down direction keys to adjust the massage speed. Press the Left, Right direction keys to adjust the airbag force.

Heat

- ▶ Press this button to turn on the heat function. An indicator light will illuminate. Press again to turn off heat function. The corresponding indicator light will turn off.

Zero Gravity

- ▶ The chair will automatically place your body into Zero Gravity Position 1 when you press the Power Button. Press this button to choose Zero Gravity Position 2. A light on the display screen will illuminate. This function will automatically shut off whenever you manually adjust the positions of the backrest or footrest.

▶ SETUP

BEFORE SITTING DOWN

- ▶ Make sure there are no objects, people, or pets in the vicinity of the unit.
- ▶ Use the controller to lower the backrest to its furthest outstretched position. Raise the legrest to its highest position. Make sure that sufficient open space surrounds the chair on all sides. Make sure that the leg rest is properly connected to the main part of the chair.
- ▶ Return the chair to its original, upright position.

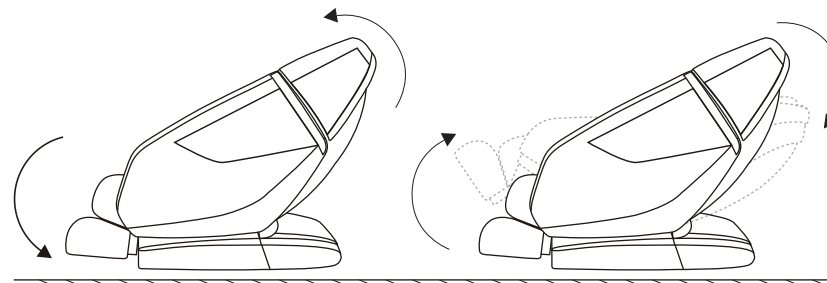

CAUTION

- ▶ Do not sit on the massage chair while the legrest is rising. To avoid possible damage, do not suddenly load the legrest with heavy weight.
- ▶ Do not allow children to play with this massage chair. If controls are tampered with, accident or injury arising from the power supply box may result.
- ▶ After your massage finishes its cycle, switch off power and remove the power plug from its wall outlet.
- ▶ Avoid operating this chair during rain and thunderstorms.
- ▶ When the chair is not in use, switch off power and remove the power plug from its wall outlet.
- ▶ If you do not plan to use the chair for an extended period of time, please put it into storage.
- ▶ Avoid dragging this chair across surfaces that can easily be damaged, such as wooden or carpeted flooring.
- ▶ To prevent electric shock, do not operate this chair within damp environments.
- ▶ Do not place this chair near a stove or other significant sources of heat. Do not expose the chair to prolonged sunlight. Damage to its leather cover may result.
- ▶ Do not hold on the legrest leg/sole massage section when moving the unit. If this is not observed, the section may slide as you move the unit, and injuries may occur.
Do not drag or push the unit in an installed state. Protect your floor (place a mat or similar) when moving the unit on its wheels to avoid damage to your floor.

▶ SETUP

3: Installing all other units

- ▶ Connect the controller to its corresponding port on the power supply box.
- ▶ Insert the power plug into a wall outlet, turn on the switch, and press the power on the remote control.

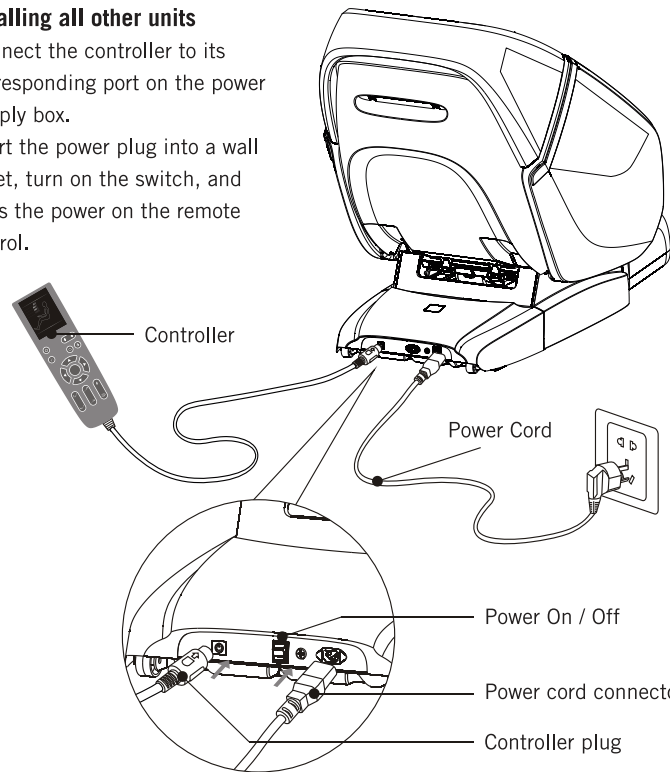

- ▶ Lift the legrest by reclining the chair. Turn off the power switch and remove the power cord. Attach the corresponding connectors to the ports located on the back of the legrest.

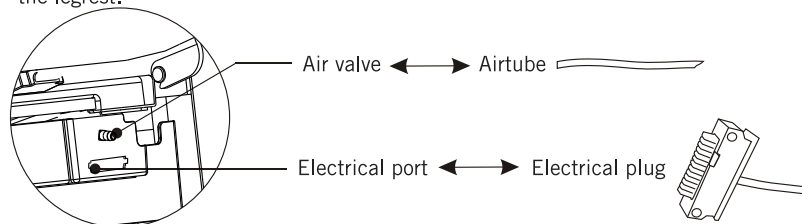

- ▶ After all parts assembled, please insert the power cord into the power socket, and then turn on the switch. Press the power on the remote control to start massage.

▶ OPERATION

Footrest Up Button

- ▶ Press and hold to raise the leg rest. Release the button when it reaches your desired position.

Footrest Down Button

- ▶ Press and hold to lower the leg rest. Release the button when it reaches your desired position.

Backrest Up Button

- ▶ Press and hold to raise the backrest. Release the button when it reaches your desired position.

Backrest Down Button

- ▶ Press and hold to lower the backrest. Release the button when it reaches your desired position.

DISPLAY SCREEN OPERATION

Automatic Programs

Press and select AUTO to bring up the Automatic Programs menu.

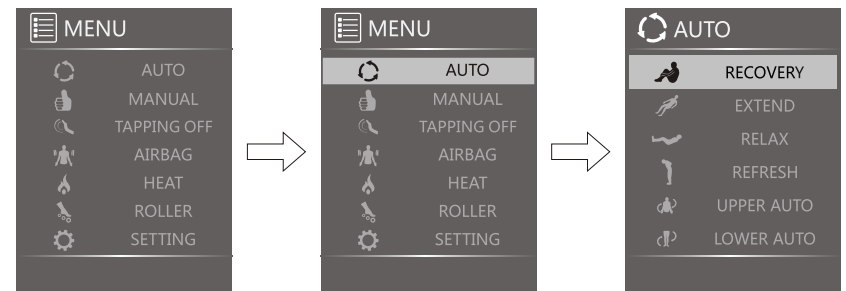

Automatic Programs can also be accessed by pressing on the remote control.



Use the Up or Down keys to highlight one of six automatic massage programs:

RECOVERY	(Warm up)
EXTEND	(Stretch)
RELAX	(Cool down)
REFRESH	(Light massage)
UPPER BODY AUTO	(Focused massage on the upper body)
LOWER BODY AUTO	(Focused massage on the lower body)

Press to select.

▶ OPERATION

Manual Programs

Press  and scroll down to the Manual option. Press the OK button to select. Press Up or Down arrow keys to choose Manual programs. Manual Programs can also be accessed by pressing  on the remote control.

MODE

Under the MODE function, press the Right arrow key to select and move on to the next menu. Press Up or Down arrow keys to choose between Kneading, Knocking, Sync, Tapping, Shiatsu or Rhythm.

When selecting Kneading, press the OK button. Press the Up or Down keys to choose between Kneading Up or Kneading Down then press the OK button.

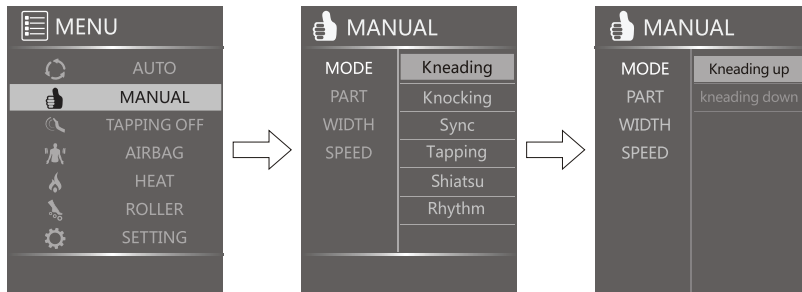

PART

Under the PART function, press the Right arrow key first, then press the Up or Down arrow keys to highlight the specific part of the body you wish to massage. PART function cannot be adjusted in Shiatsu.

WIDTH

Under the WIDTH function, press the Right arrow key first, then press the Up or Down arrow keys to highlight your desired width of the massage rollers. WIDTH cannot be adjusted in Kneading, Sync and Rhythm.

SPEED

Under the SPEED function, press the Right arrow key first, then press the Up or Down arrow keys to choose your desired massage roller speed. SPEED cannot be adjusted in Shiatsu or Rhythm.

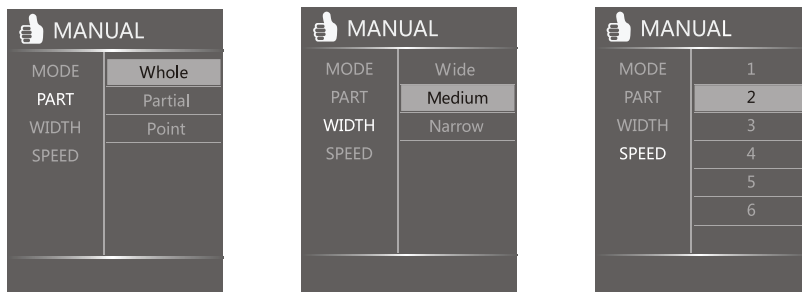

▶ SETUP

Installation Method

1: Carefully lift the chair and all of its parts from their packaging.

▶ Remove any protective wrapping. Check to make sure that all parts are present.

2: Installing the Legrest

▶ Lift the legrest and connect it with the coupling shaft by hanging (pay attention to the balance), move the hook to one side of the coupling shaft, then attach the other side.

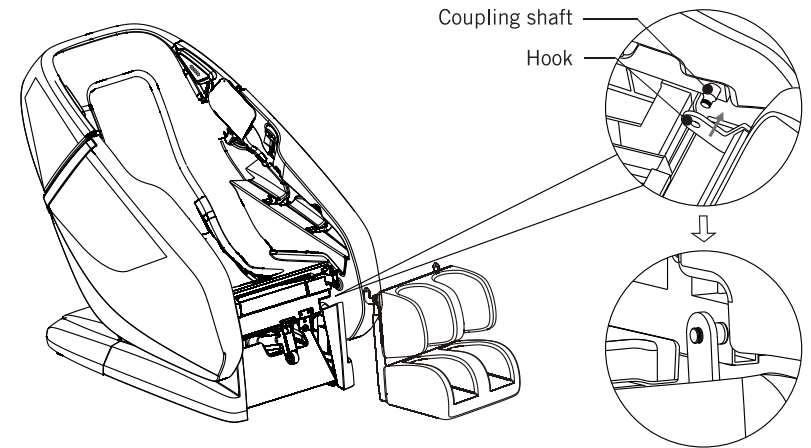

▶ After the legrest is in its place, lock it in place by sliding the lock onto the connecting rod.

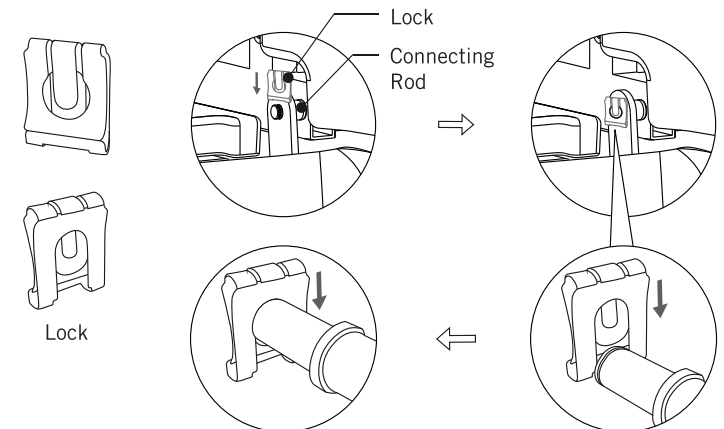

▶ OPERATION

Notes: Upon making any selections within the Automatic or Manual Mode menus, after 10 seconds of inactivity, the display screen will return to the home page.

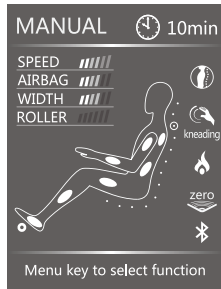

Home Page in Manual Mode

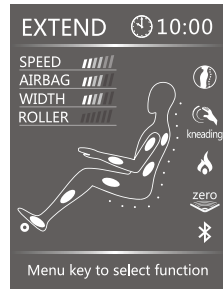

Home Page in Automatic Mode

⚠ CAUTION

- ▶ To avoid possible damage, keep water and other liquids away from the controller.
- ▶ Do not crush the controller or power cord under any heavy object.

BUZZER

With BUZZER highlighted, press the Right arrow key. Press Up or Down keys to turn the beeping button tone on or off.



▶ OPERATION

TAPPING OFF

Press first. Select TAPPING OFF and press the OK button. Press the Right arrow key first, then press the Up or Down arrow keys to turn the Tapping On or Off during the Automatic Programs.

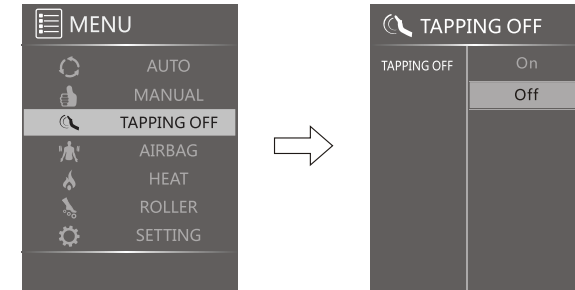

AIRBAG

Press first. Select AIRBAG mode and press the OK button. Press the Right arrow key first, then press the Up or Down arrow keys to choose your desired PART and FORCE.

PART

Under the PART function, press the Right arrow key first, then press Up or Down arrow keys to choose between Full, Arm & Shoulder, Leg & Foot, and Back.

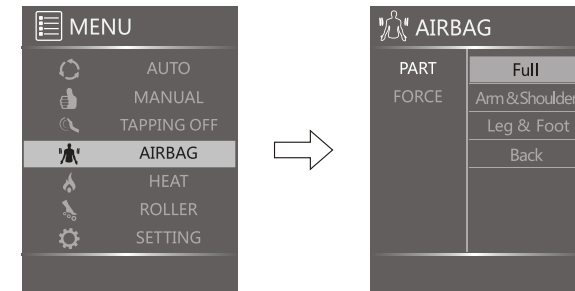

FORCE

Under the FORCE function, press the Right arrow key first, then press Up or Down arrow keys to choose your desired massage force or turn off.

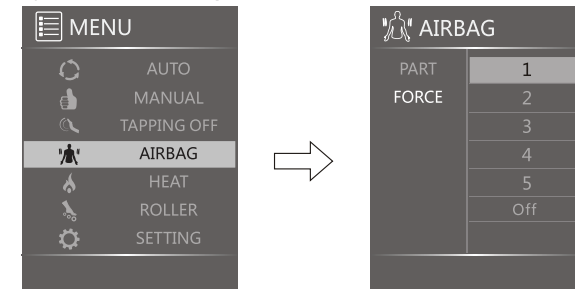

▶ OPERATION

HEAT

Press  first. Select HEAT mode and press the OK button. Press the Right arrow key first, then press the Up or Down arrow keys to choose desired heat or turn off.

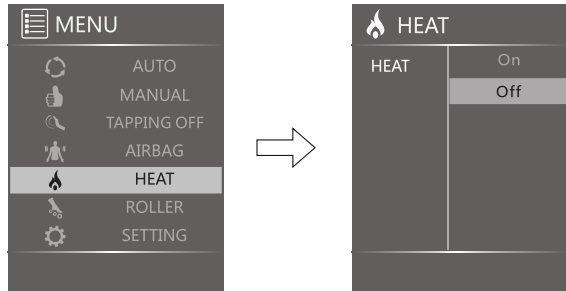

ROLLER

Press  first. Select ROLLER mode and press the OK button. Press the Right arrow key first, then press the Up or Down arrow keys to choose your foot roller speed or turn off.

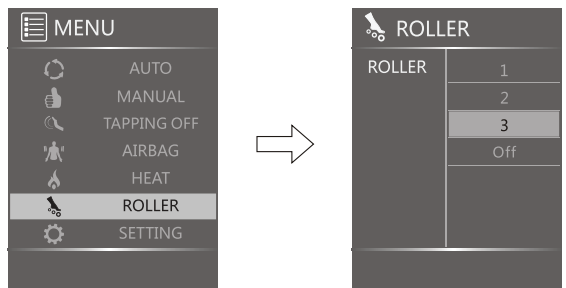

SETTING

Press  first. Select SETTING mode and press the OK button. Press Up or Down arrow keys to choose Time, Language, Music, USB, Bluetooth, or Buzzer.

TIME

With TIME highlighted, press the Right arrow key. Press Up or Down keys to select your desired length of time for each massage: 10, 20, or 30 minutes. Press the OK button to select.

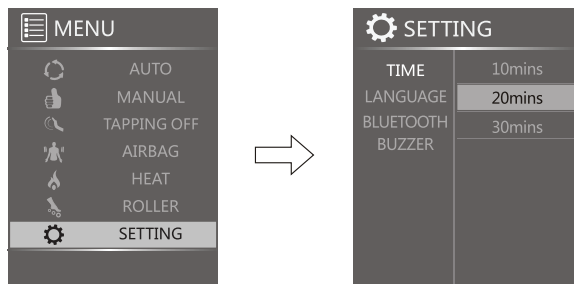

▶ OPERATION

LANGUAGE

With LANGUAGE highlighted, press the Right arrow key. Press Up or Down keys to select desired language to appear on the display screen.

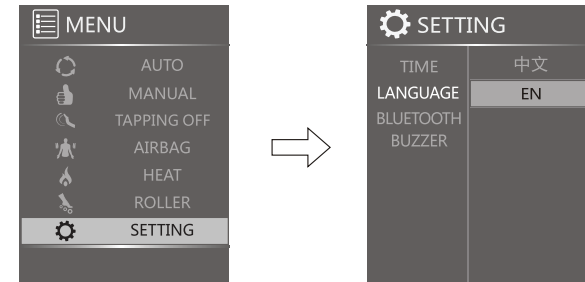

BLUETOOTH

With BLUETOOTH highlighted, press the Right arrow key. Press Up or Down keys turn this function on or off. Music and volume will be controlled through the device, not the remote.

