



Deluxe Multi-function Massage Chair

RT6810S  
USER MANUAL

Please read all instructions carefully before using.

Thank you for purchasing this product.  
 Please read this user manual carefully before using to ensure proper operation.  
 Please keep this USER MANUAL properly for future reference.

## ▶ CONTENTS

SAFETY PRECAUTIONS .....	1
NAME AND FUNCTION OF EACH COMPONENT.....	3
External Structure .....	3
Internal Structure .....	3
Power Box.....	4
Armrest Control Panel.....	5
Instructions of Armrest Control Panel.....	6
Controller .....	8
Instructions of Controller.....	9
Display Screen Instructions.....	10
MOBILE PHONE HOLDER.....	14
PREPARATION BEFORE USING .....	15
Installation Methods.....	15
Commissioning .....	16
Before Sitting in the Chair .....	16
Moving the Massage Chair.....	17
Connecting to Power.....	17
Position & Placement for Installation.....	18
Floor Protection .....	18
Surrounding Environment.....	19
Grounding .....	19
Care and Maintenance .....	20
TRUBLE SHOOTING.....	21
PRODUCT SPECIFICATIONS.....	21

## ▶ TROUBLE SHOOTING

No.	Symptoms	Possible Causes	Possible Solutions
1	Noise is heard while in use	This sound is normal and comes from the motor or massager rubbing against the cloth cover	No need to take any measures
2	Appliance does not start	The power cord is not secured into the socket	Insert the power plug properly into the power socket
		Power switch is off	Turn on the switch
		The fuse is blown	Replace only with a fuse of same type and rating
3	Airbag malfunction	The air hose is blocked	Straight the air hose and clear out the blockage

If problem remains, please contact the dealer for maintenance.

Important: Do not attempt to repair this product yourself, our company shall not be liable for the injury or damage caused by any servicing without authorization.

Thank you for your cooperation.

## ▶ PRODUCT SPECIFICATIONS

Product Name: Deluxe Multi-function Massage Chair  
 Model Number: RT6810S  
 Rated Voltage: 220V  
 Rated Frequency: 50HZ  
 Rated Power: 135W  
 Safety Design: Class I

## CARE AND MAINTENANCE

### Care and Maintenance Instructions

- ▶ To treat stains on back panel, armrest, footrest, plastic parts or air hose, spot clean with mild detergent foam, then wipe it with a dry cleaning cloth.
- ▶ To treat stains on controller, power box, spot clean with a dry cleaning cloth.
- ▶ To treat stains on back cushion or pillows, use a water-based upholstery cleaner only, wipe it with moist cloth, then air dry.
- ▶ To clean the foot/calf unit covers, remove it from the chair, hand wash with a mild detergent, then line dry.

#### CAUTION

- ▶ Pull out the power cord from the power strips before care and maintenance. To avoid electrical shock or injury, do not touch the power cord with wet hands. Make sure no detergent enters into the power box while cleaning.
- ▶ Do not use benzene, thinner or other solvents on your product, it may cause fading or damage to the product.
- ▶ Do not iron the upholstery.

### Storage Methods

- ▶ Keep the product free from dust. Cover the product with a dust-free cloth to prevent collection of dust if not in use of a long period of time.

#### CAUTION

- ▶ Do not leave this product exposed to direct sunlight for long periods of time. This may cause fading or damage.

### Warm Tips

During daily use, please check for the following symptoms:

- ▶ Burnt smell.
- ▶ The product experiences unusual power ON/OFF when touching the power cord.
- ▶ Hot power cord.
- ▶ Other abnormal symptoms.

#### CAUTION





- ▶ Please stop using the product to avoid breakdowns or accidents if any above symptom spotted.
- ▶ Switch off the power button and disconnect the plug, contact the local distributors or supplier for repair.
- ▶ All other servicing except above care and maintenance should be serviced by an authorized dealer or service center.

#### WARNING

Pull out the power cord from the power strips before care and maintenance. To avoid electrical shock or injury, do not handle the power cord with wet hands. Do not try to dismantle or repair the product yourself, please send your massage chair to the authorized service center.

## SAFETY PRECAUTIONS

- ▶ Precautions listed below will help to ensure proper use of this appliance.
- ▶ The hazard that may cause by incorrect use are classified into “WARNING” and “CAUTION”, please ensure that you read all instructions before using the massage chair.

 <b>WARNING</b>	Improper operation may cause severe personal injury or substantial property damage.		
 <b>CAUTION</b>	Improper operation may cause personal injury or product damage.		
	Prohibited		No Disassemble

### Not Suitable For Below Persons

We recommend that those with any of the following conditions should consult your physician before using.

- |   |   |
|---|---|
| <br><b>WARNING</b> | <ul style="list-style-type: none"> <li>◆ Those who are using electronic medical instrument embedded in the body, such as cardiac pacemaker.</li> <li>◆ Those undergoing treatment, especially those who are not feeling well.</li> <li>◆ Those with malignant tumors or malignant abscesses. (Need to be supervised)</li> <li>◆ Women who are pregnant or menstruating.</li> <li>◆ Those with osteoporosis or fracture spine.</li> <li>◆ Those with skin disease or those whose skins are injured.</li> <li>◆ Those with high fever.</li> <li>◆ Close supervision is necessary when this product is used by, on, or near children, invalids, or disabled persons</li> <li>◆ The appliance has a heated surface. Persons insensitive to heat must be careful when using the appliance.</li> <li>◆ This appliance can be used by children aged from 8 years and above and persons with reduced physical, sensory or mental capabilities or lack of experience and knowledge if they have been given supervision or instruction concerning use of the appliance in a safe way and understand the hazards involved.</li> <li>◆ Children shall not play with the appliance.</li> <li>◆ Cleaning and user maintenance shall not be made by children without supervision.</li> </ul> |
|---|---|

### Controller Precautions

- |   |   |
|---|---|
| <br><b>CAUTION</b> | <ul style="list-style-type: none"> <li>◆ Do not operate the controller or pull the controller cable with damp hand.</li> <li>◆ Do not spill water or other liquid onto the controller to avoid fault.</li> <li>◆ Do not lay heavy objects on the controller.</li> </ul> |
|---|---|

### Cautions Regarding the Adapters and Cord



- |   |  |
|---|--|
| <br><b>CAUTION</b> | <ul style="list-style-type: none"> <li>◆ Always unplug this appliance from the electrical outlet immediately after using and before cleaning.</li> <li>◆ An appliance should never be left unattended when plugged in. Unplug from outlet when not in use.</li> <li>◆ Unplug from outlet during thunder or lightning storms, and before putting on or taking off parts.</li> <li>◆ Never operate this appliance if it has a damaged cord or plug, if it is not working properly, if it has been dropped or damaged, or dropped into water. Return the appliance to a service center for examination and repair.</li> <li>◆ Check that the power voltage stated on the rating label corresponds to your local electricity supply.</li> <li>◆ Do not use a damp hand to unplug the cord to avoid electric shock.</li> <li>◆ Do not drag the cord, reach to the front plastic end to unplug it.</li> <li>◆ Do not squeeze, over bend, pull hard, twist the cord.</li> <li>◆ Keep the cord away from heated surfaces.</li> <li>◆ Do not carry this appliance by supply cord or use cord as a handle.</li> <li>◆ To disconnect, turn all controls to the off position, then remove plug from outlet.</li> <li>◆ The appliance is only to be used with the power supply unit provided with the appliance.</li> <li>◆ It must only be supplied at safety extra low voltage corresponding to the marking on the appliance.</li> <li>◆ If the supply cord is damaged, it must be replaced by the manufacturer or its service agent or a similarly qualified person in order to avoid a hazard.</li> </ul> |
|---|--|

## SAFETY PRECAUTIONS

### Best Circumstances

 <b>CAUTION</b>	<ul style="list-style-type: none"> <li>◆ Do not operate under blanket or pillow. Excessive heating can occur and cause fire, electric shock, or injury to persons.</li> <li>◆ Do not use this appliance where temperature is over 40°C.</li> <li>◆ Do not use this appliance in humid or dusty environment, or when any part of the body is in contact with plumbing or any similar ground.</li> <li>◆ Never operate the appliance with the air openings blocked. Keep the air openings free of lint, hair, and the like.</li> <li>◆ Do not use outdoors.</li> <li>◆ Please place the product on the flat level floor.</li> <li>◆ Do not store near heat or open flame.</li> <li>◆ Connect this unit to a properly grounded outlet only. See Grounding Instructions.</li> </ul>
---	---

### Best Practices For Safe Use

 <b>CAUTION</b>	<ul style="list-style-type: none"> <li>◆ Only for users weighs below 120kg.</li> <li>◆ Use this product only for its intended use as described in this manual. Do not use attachments not recommended by the manufacturer.</li> <li>◆ Do not use the product for therapeutic treatment purpose.</li> <li>◆ Appliance should only be used by one person, do not use by two or more persons at the same time to avoid damage to the products.</li> <li>◆ Do not use the product right after meal, it may cause discomfort.</li> <li>◆ Remove the accessories from the arms and empty the pockets while use the massage services.</li> <li>◆ Check the upholstery under the cushions and other spots, if any damages are present, do not use it and refer to a qualified service professional for servicing.</li> <li>◆ If you feel any abnormal discomfort during the operation of this product, turn off the power immediately and do not use the product.</li> <li>◆ Use the appliance for 20 minutes each time is highly recommended</li> <li>◆ Make sure there is no obstacles behind the chair and there is enough clearance before adjusting the backrest or legrest angle.</li> <li>◆ Make sure no other excessive load pressed on the backrest or legrest besides the user.</li> <li>◆ Make sure there is no children, pets or other objects under the backrest or legrest.</li> <li>◆ Please be seated properly while using the appliance.</li> <li>◆ Do not drag or push the chair or roll on its caster on wood floor or carpet to avoid damage.</li> </ul>
 <b>PROHIBITED</b>	<ul style="list-style-type: none"> <li>◆ Do not stand on or stack heavy objects on the footrest.</li> <li>◆ Do not fall into sleep while the product is operating.</li> <li>◆ Avoid using the product under the influence of alcohol.</li> <li>◆ Never drop or insert any object into any openings.</li> <li>◆ If there is any smoke or unusual smell while using, stop using immediately, unplug the power cord.</li> </ul>
 <b>NO DISASSEMBLY</b>	<ul style="list-style-type: none"> <li>◆ Do not disassemble this product yourself to avoid failure.</li> <li>◆ Do not dismantle, fix or modify the yourself, please contact authorized dealer or service agent.</li> </ul>

## PREPARATION BEFORE USING

### Surrounding Environment



Keep the massage chair away from damp places to avoid electrical hazards.



Keep the massage chair away from high temperature sources to avoid fire or damage to the leather materials.



### WARNING

- ▶ Do not use the massage chair in high moisture environment such as near swimming pool or bathroom to prevent electric shock accident.
- ▶ Please keep the massage chair away from heated surfaces to prevent fire hazard or damage to the product.

### Grounding Instructions

- ▶ This product must be grounded. If it should malfunction or breakdown, grounding provides a path of least resistance for electric current to reduce the risk of electric shock. This product is equipped with a cord having an equipment-grounding conductor and a grounding plug. The plug must be plugged into an appropriate outlet that is properly installed and grounded in accordance with all local codes and ordinances.



This product must be grounded, the plug must be plugged into an appropriate 3-wire grounded outlet that is properly installed and grounded in accordance with all local codes and ordinances to reduce risk of electrical shock.

### After Use

- ▶ Always turn off the power switch and unplug the massage chair from the electrical outlet immediately after use.
- ▶ Put the controller into the pocket; when not in use for a long period of time, we recommend that the chair be covered, the power cord be coiled and that the unit be placed in an environment free of dust and moisture.

## ► PREPARATION BEFORE USING

### Installation Site

#### Clearance space for the massage chair:

- Ensure there is an adequate clearance for the installation: It needs 15 cm clearance for the reclination of the backrest; It needs 20cm clearance space for the extension of footrest and sliding forward of the chair.

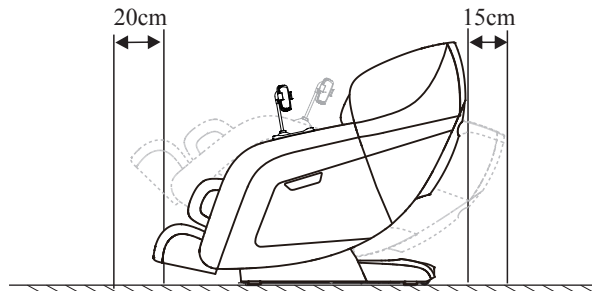

### Floor Protection

- We recommend to place a piece of carpet or soft mat underneath it to avoid damaging the floor.

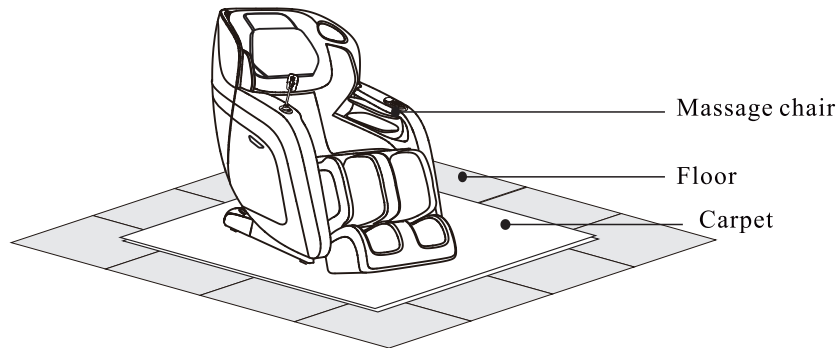

## ► NAME AND FUNCTION OF EACH COMPONENT

### External Structure

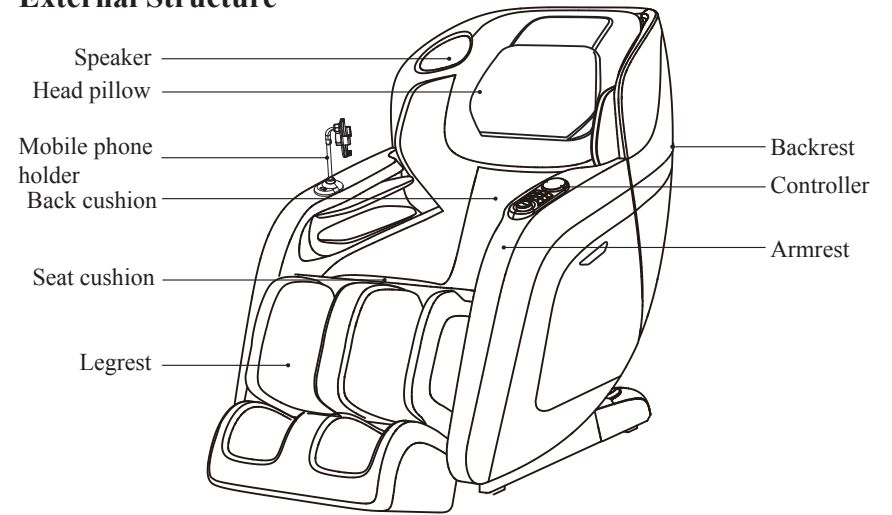

### Internal Structure

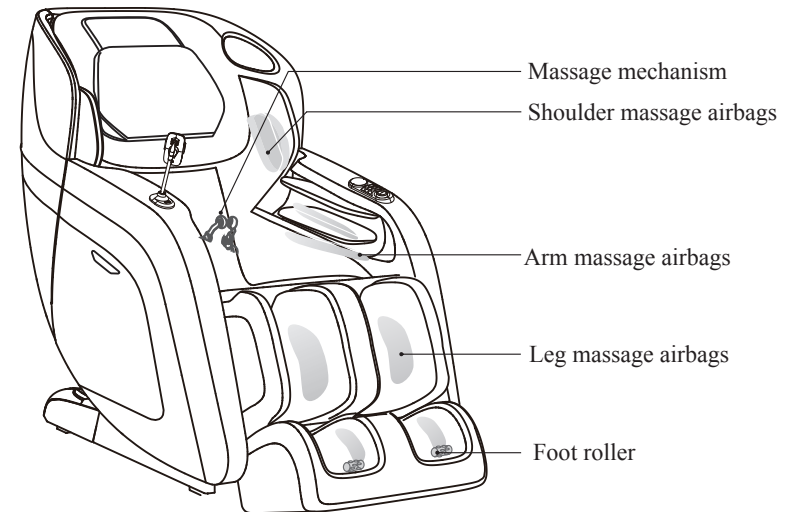

## ▶ NAME AND FUNCTION OF EACH COMPONENT

### Power Box

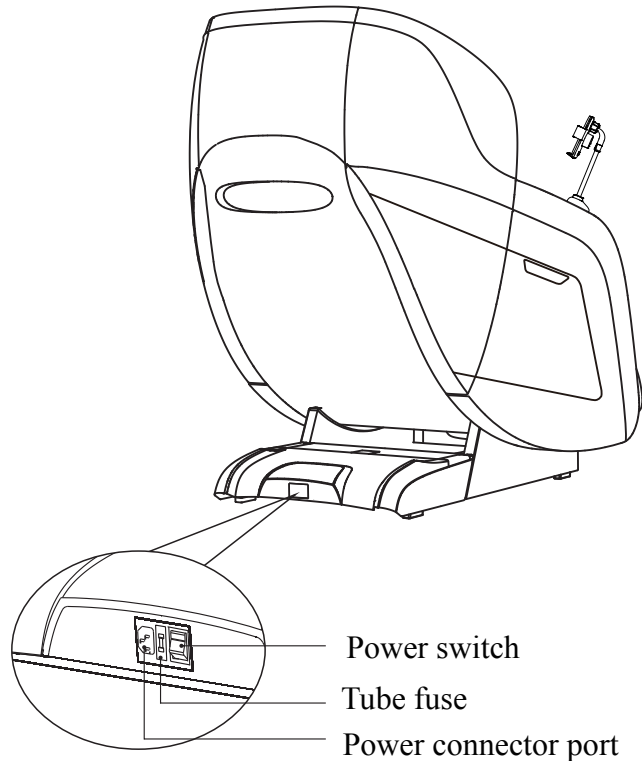

**⚠ CAUTION**

- ▶ Children should be supervised to ensure that they do not play with the chair or touch the power box.
- ▶ Always unplug the massage chair from the electrical outlet immediately after use.
- ▶ Unplug from outlet during thunder or lightning storms, and before putting on or taking off parts.
- ▶ Turn off the power switch and unplug the massage chair from the electrical outlet while not in use to avoid children power on the massage chair accidentally.
- ▶ When not in use for a long period of time, we recommend that the chair be covered, the power cord be coiled and that the unit be placed in an environment free of dust and moisture.

## ▶ PREPARATION BEFORE USING

### Move Methods

- ▶ Roll the chair on its casters to the desired location.
- ▶ Incline the backrest to upright position.
- ▶ Turn off the power switch and unplug the appliance from the electrical outlet.
- ▶ Using two people, push down on the backrest and lift up on the front side by grabbing the moving Holder located to the front bottom of the armrest, roll the chair on its casters to the desired location (check the sketch for reference).

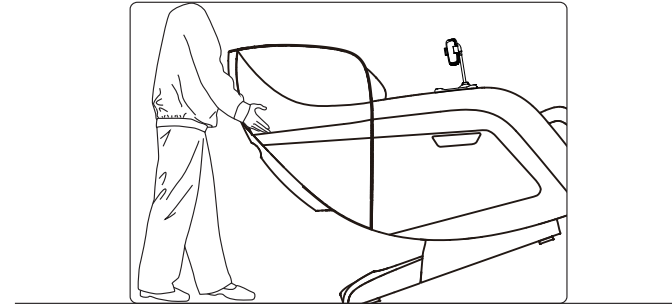

**⚠ CAUTION**

- ▶ Do not move the chair when there is user inside.
- ▶ To carry this product, do not lift by the footrest or armrest, hold the chassis and steady the backrest (have 4 or more people to carry the product).

### Connect to Power

- ▶ Connect this appliance to a 3-wire properly grounded outlet.
- ▶ Turn on the main power switch by the right hand side of the massage chair.

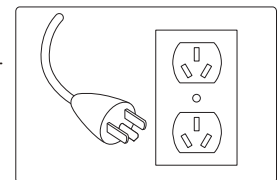

**⚠ CAUTION**

- ▶ Please verify that there is no damage to the supply cord before switching on the massage chair.
- ▶ Please verify that the main power switch is turned off before connecting to power.

## ▶ PREPARATION BEFORE USING

- ▶ Connect the power cable to the product power connector port located at the power box of the product.

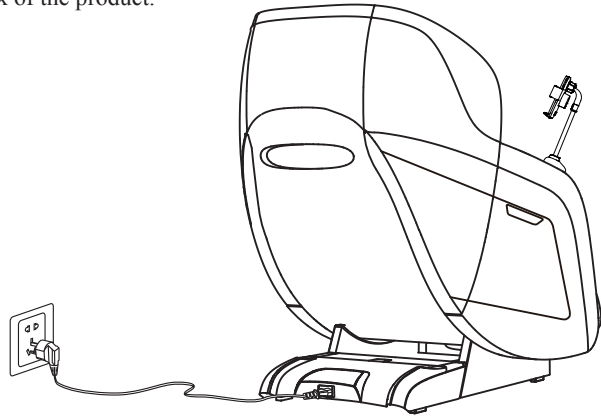

### Commissioning

- ▶ Use the remote control to recline the backrest to its lowest position, raise and extend the footrest to its top position, make sure there is enough clearance before commissioning.
- ▶ Return the backrest and footrest back to its default position after commissioning and turn off the power switch.  
To choose the massage program, please check the Instructions of Remote Control and Instructions of Display Screen for reference.

### Before Sitting in the Chair

- ▶ Ensure the footrest is well assembled before sitting on the massage chair.
- ▶ Ensure the massage chair is returned to its original position before sitting on it.

### ⚠ EARTHING

This massage chair belongs to Level One electrical appliance, make sure to use three-core power supply socket and to guarantee the ground wire connected to the power supply socket has obtained good ground connection to avoid electric leakage, electric shock and some other negative effect during use.

## ▶ NAME AND FUNCTION OF EACH COMPONENT

### Armrest Control Panel

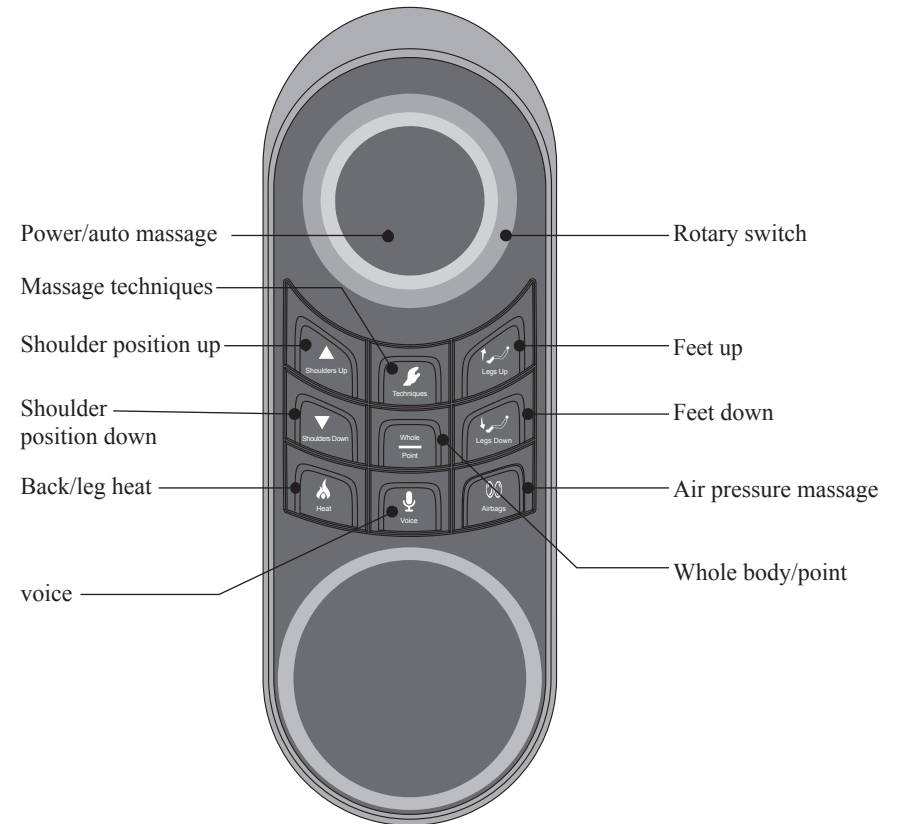

## ▶ NAME AND FUNCTION OF EACH COMPONENT

### Instructions of Armrest Control Panel



#### Power/auto Massage Button

- ▶ When massage chair is connected to power, long press this button to power on the controller (white indicator surrounding the button lights up), then short press this button to start auto massage program, you may toggle among 9 pre-set auto massage



#### Rotary Switch

- ▶ When massage chair is on, rotate this switch to incline/recline the backrest: rotate clockwise to incline backrest, rotate counterclockwise to recline backrest.



#### Shoulder Position Up Button

- ▶ When in point massage mode, press and hold this button to move the rollers up, release the button to stop.
- ▶ When yellow indicators of both buttons blink in auto massage mode, press and hold this button to move the rollers up to the desired position.



#### Shoulder Position Down Button

- ▶ When in point massage mode, press and hold this button to move the rollers down, release the button to stop.
- ▶ When yellow indicators of both buttons blink in auto massage mode, press and hold this button to move the rollers down to the desired position.



#### Back/Leg Heat Button

- ▶ When connected to power, press this button to turn on the back/leg heat (red indicator lights up); press again to turn off the back/leg heat (red indicator lights down).



#### Massage Techniques Button

- ▶ When massage chair is on/in auto massage mode, short press this button to start manual massage program, you may toggle among 5 massage techniques.



#### Whole Body/Point Button

- ▶ When massage chair is in manual massage mode, press this button to hold the rollers to current position, press this button again to stop point mode and start whole body mode.

## ▶ PREPARATION BEFORE USING

### Installation Methods

Step 1: Take all massage chair units out of the cartons

- ▶ Before beginning installation, please verify that all components are included (check with the packing list carefully)

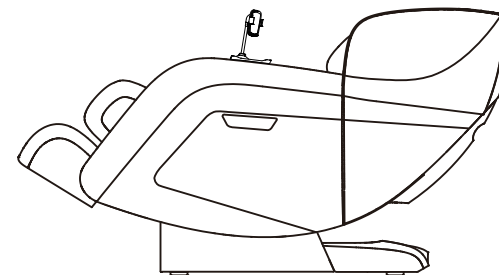

Step 2, Install mobile phone holder

- ▶ Unpack the cartons, take out the mobile phone holder assembly parts out of the cartons. Unscrew the locknut and thread it onto the clamp arm, put the ball joint into the cradle threaded hole, then tighten the screw.

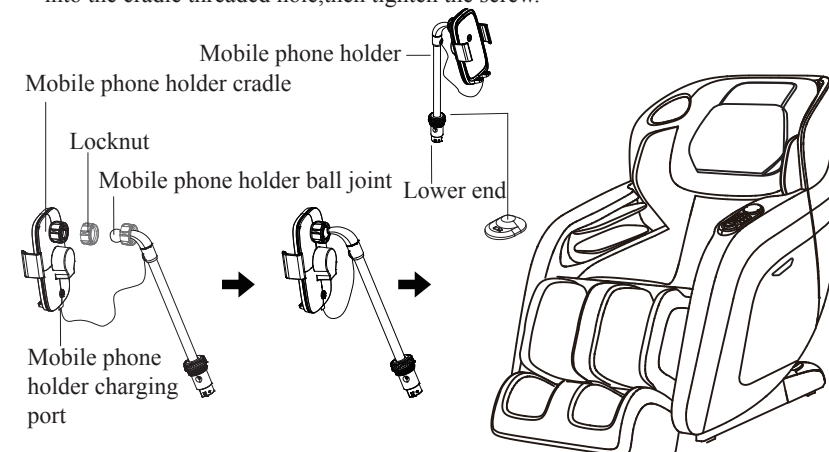

- ▶ Insert the lower end of mobile phone holder into the socket, turn the locknut clockwise to secure the holder into place (make sure the cradle face to the chair side).
- ▶ Connect the clamp arm power cord with the cradle charging port.



## MOBILE PHONE HOLDER

### Mobile Phone Holder Instructions

When connected to power, the red and green indicator lights up and goes off soon, wait 3-5 seconds and touch the bottom grip (or release button) to clamp the cradle (it defaults to clamp for the first touch), touch again to slide open the left and right arms of cradle. The red indicator is steady during charging and it blinks when not in charging. Red indicator goes off and green indicator lights up when charging is completed.

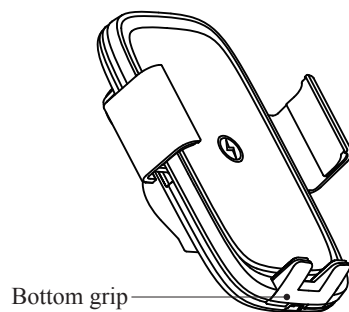
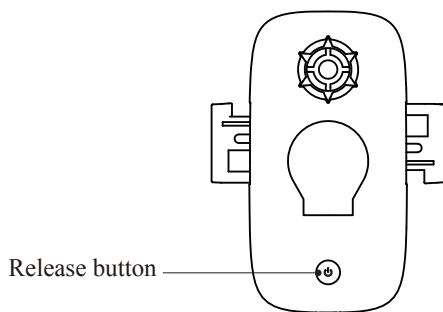

## NAME AND FUNCTION OF EACH COMPONENT



### Control Panel Prompt Voice On/off Button

▶ When massage chair is on, press this button to turn on/off control panel prompt voice (default setting is on).



### Feet Up

▶ Press and hold to raise the footrest; release the button to stop.



### Feet Down

▶ Press and hold to lower the footrest; release the button to stop.



### Air Pressure Massage Button

▶ When massage chair is on, press this button to toggle among whole body air pressure massage, shoulder air pressure massage, arm air pressure massage and leg air pressure massage.



### Tips

▶ When press and hold the button, the button indicator lights turns to yellow, indicator light goes off when release the button.



### WARNING

Do not operate the control panel with wet hands to avoid electric shock or injury.

Do not spill water or other liquid into the remote control to avoid fault.

## ▶ NAME AND FUNCTION OF EACH COMPONENT

### Controller

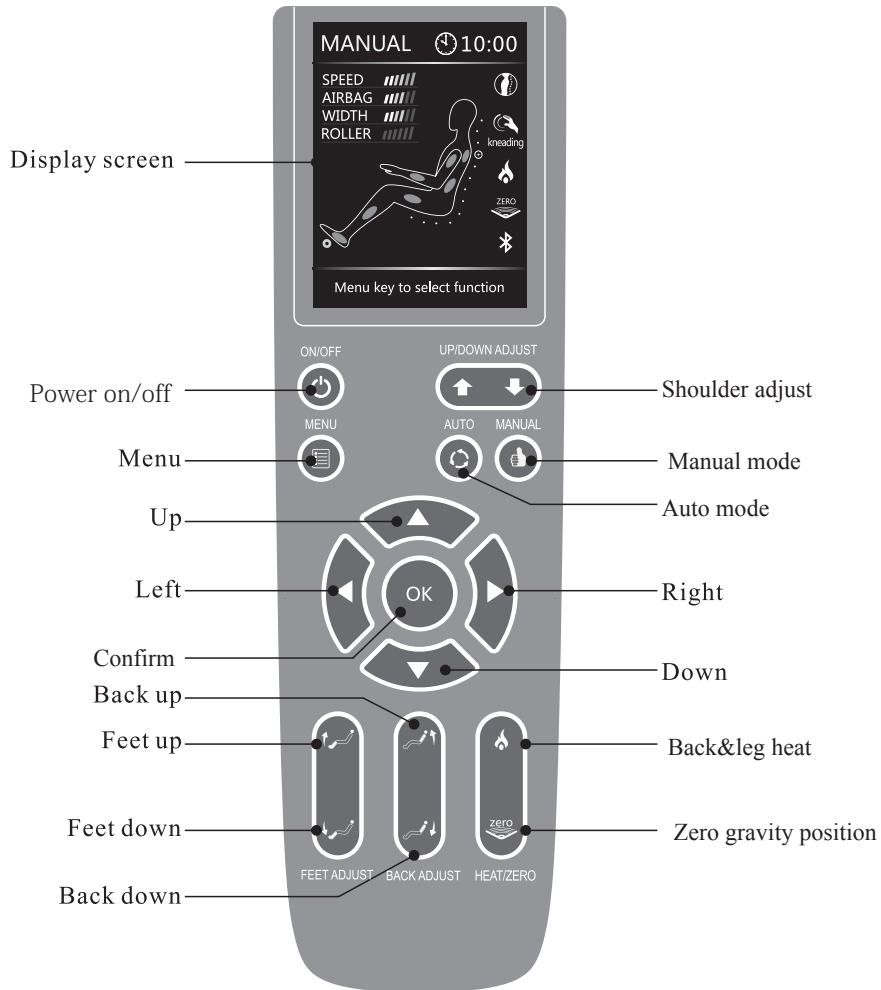

## ▶ NAME AND FUNCTION OF EACH COMPONENT

### ▶Back&leg Heat

Press HEAT from MENU display,press RIGHT then press UP or DOWN button to turn On/Off back&leg heat,Press OK button to enter the heat setting you desire.

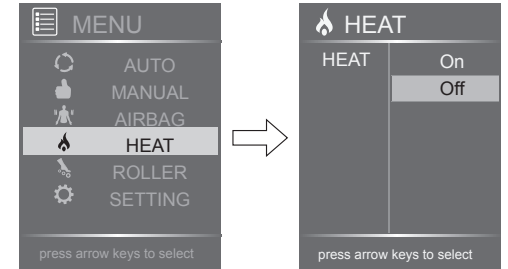

### ▶Foot Roller

Press ROLLER from MANU display,press RIGHT button then press UP or DOWN button to navigate among foot roller speed:level 1,2,3,or OFF (deactivate foot roller) . Press OK button to enter the speed level you desire.

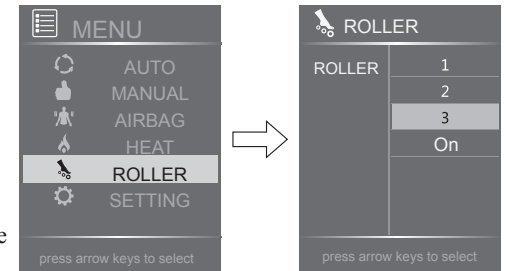

### ▶Settings

Press SETTING from MENU display,then press UP or DOWN button to navigate between:TIME and LANGUAGE.

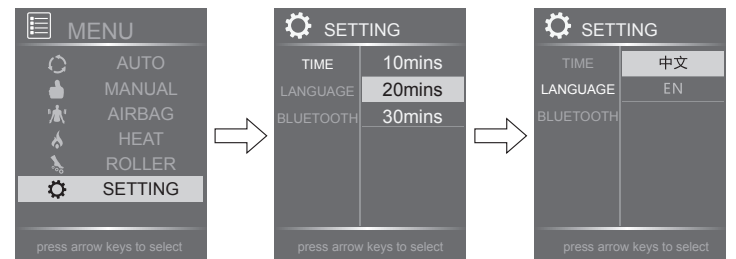

### ▶Message Time

Time:Press TIME from SETTING to show available timer: 10mins,20mins,30mins. press RIGHT button then press UP or DOWN button to navigate,press OK button to enter the timer you desire.

### ▶Language

Press LANGUAGE from SETTING to show available language: 中文, EN.press RIGHT button then press UP or DOWN button to navigate,press OK button to enter the language you desire.

## NAME AND FUNCTION OF EACH COMPONENT

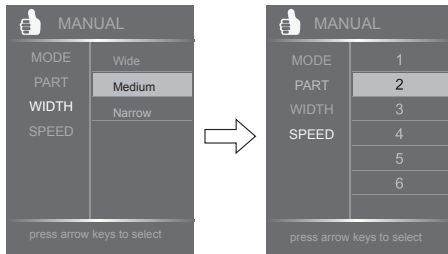

### Roller Width

Press WIDTH from MANUAL display, press RIGHT button then press UP or DOWN button to navigate among: Wide, Medium and Narrow mechanism roller width. Press OK button to enter the setting you desire. Selected width will show on the home screen. (Not adjustable in manual mode-kneading/sync)

### Mechanism Massage Speed

Press Speed from MANUAL display, press RIGHT button then press UP or DOWN button to navigate among: level 1, 2, 3, 4, 5, 6 Mechanism massage speed. Press OK button to enter the speed level you desire.

### Airbag

▶ Press AIRBAG from MENU display to show the AIRBAG display, press RIGHT button then press UP or DOWN button to navigate between: PART-Air pressure region and FORCE-Air pressure intensity, Press OK button to enter the setting you desire.

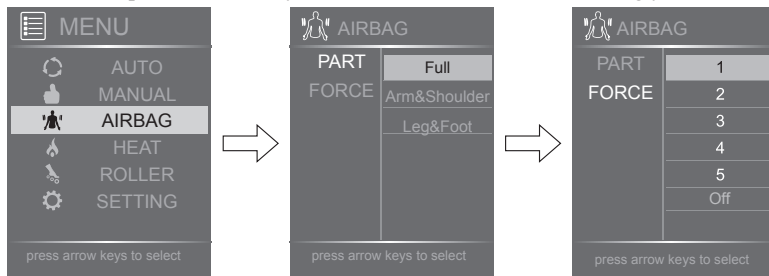

### Part-Air pressure region

Press PART from AIRBAG display, press RIGHT button then press UP or DOWN button to navigate among: Full, Arm&Shoulder, Leg&Foot positions. Press OK button to enter the airbag position you desire.

### Force-Air pressure intensity

Press INTENSITY from Airbags display, press RIGHT button then press UP or DOWN button to navigate among: 1, 2, 3, 4, 5 air pressure intensity, press OK button to enter the airbag setting you desire.

## NAME AND FUNCTION OF EACH COMPONENT

### Instructions of Controller

- Power On/Off**  Press this button to power on/off the controller.
  - ▶ Press this button while connected to power to show the menu display, the LCD Screen is lit, use the UP/DOWN/LEFT/RIGHT buttons to navigate the screen, press OK to select.
  - ▶ Press this button again to turn off the product.

- Menu** 
  - ▶ Display the Auto Program, Manual Program, Airbag, Heat, Roller and Setting function. (Check the Display Menu for detailed information)

- Shoulder Position Adjust**  (Moves mechanism up and down)
  - ▶ Press and hold on Position UP/DOWN ADJUST button to adjust the rollers to the desired position while in Manual-Point massage mode.
  - ▶ While body scanning is working, use this two buttons to slightly adjust mechanism up/down the shoulder.

- Auto Program** 
  - ▶ Press to display the auto mode menu. when an auto program is running, press this button to toggle among the auto programs. the active program displays at the top of the status screen. (Check the Display Menu for detailed information)

- Manual Programs** 
  - ▶ Display the manual mode menu, press UP or DOWN button to navigate among: Kneading, Knocking, Sync, Tapping and Shiatsu. (Check the Display Menu for detailed information)

- Navigation** 
  - ▶ Use the UP/DOWN/LEFT/RIGHT arrow buttons to navigate the screen, press OK to select.

- Back&leg Heat** 
  - ▶ Press to turn on backrest and legrest heat, the heat icon will be lit on display screen; press again to turn off backrest and legrest heat, the heat icon will be off.

- Zero Gravity** 
  - ▶ Press to position the chair in Zero Gravity Position, the Zero Gravity Position icon will be lit on display screen; press again to close the Zero Gravity Position, the Zero Gravity Position icon will be off.

## NAME AND FUNCTION OF EACH COMPONENT



### Feet Up

▶ Press and hold to raise the Legrest, release the button to stop.



### Feet Down

▶ Press and hold to lower the footrest, release the button to stop.



### Back Up

▶ Press and hold to raise the backrest, release the button to stop.



### Back Down

▶ Press and hold to lower the backrest, release the button to stop.

## Display Screen Instructions

### ▶ Auto Massage Program

Press to display the Auto Program menu, press this button to toggle among 9 Auto Programs: Recover, Extend, Relax, Refresh, Neck&Shoulder, Waist&Spine, Royal Treatment, Queen Slimming and Soul Spa. Press OK to enter the program you desire. Selected program will show on the home screen. (Check the Display Menu for detailed information)

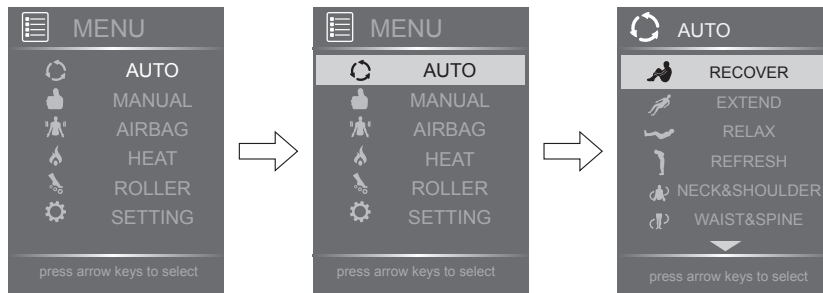

### Recover

Designed for after work recovery, it helps to release the fatigue and speed recovery.

### Extend

Inspired by Thai style massage, featured in extension and stretching, this massage program uses strong kneading and stretching techniques to relax tired muscles and keep them flexible.

### Relax

Designed for morning or midday relaxing, it helps to boost the viability of muscles.

## NAME AND FUNCTION OF EACH COMPONENT

### Refresh

Focusing on tight and sore muscles, it helps to relieve waist, back and neck pain.

### Neck&Shoulder

Helps to loosen the stiff muscles in the neck and shoulders.

### Waist&Spine

Helps to soothe the tension and keep the vitality of muscles in the back and waist.

### Royal Treatment

Delivers an intense massage focusing on relieving sore and tension in the neck and shoulders, bringing utmost relief and comfort for users who spend long hours at desk.

### Queen Slimming

Adopts mild massage techniques to relax muscles in the back and waist, helping to shape body figure and promote metabolism.

### Soul SPA

This massage program is designed for morning or midday relaxing, it helps to de-stress, clear mind and increase productivity.

### ▶ Manual Massage Programs

Press MANUAL from MENU display, press UP or DOWN button to navigate among: MODE, PART, WIDTH and SPEED.

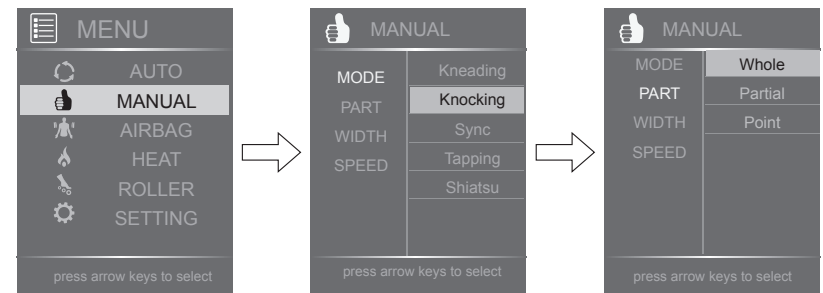

### Massage Mode

Press MODE from MANUAL display, press RIGHT button then press UP or DOWN button to navigate among:

Kneading, Knocking, Sync, Tapping and Shiatsu massage techniques. Press OK button to enter the setting you desire. Selected mode will show on the home screen.

### Massage Part

While Manual massage program is running, press this button to navigate among: Whole, Partial and Point massage regions.

