

Thank you for purchasing this product. Please read this user manual carefully before using appliance to ensure proper operation.

Please keep this USER MANUAL properly for further reference.

▶ CONTENTS

SAFETY INFORMATION	1
NAME AND FUNCTION OF EACH COMPONENT	3
External Structure	3
Internal Structure	3
Power Box	4
Controller	5
Instruction Of Controller	6
Instruction of Display Screen Menu	7
APP DOWNLOAD AND INSTALLATION	11
PRELIMINARY CHECKS	13
Legrest Massage Unit Instruction	13
Installation Method	13
Commissioning	15
Before Sitting	15
Move Method	15
Connect To Power	15
Installation Site	16
Floor Protection	16
Best Circumstances	16
Grounding	16
CARE AND MAINTENANCE	17
TROUBLE SHOOTING	18
PRODUCT SPECIFICATIONS	19

Below Form Shows The Name And Content Of Hazardous Substance In This Product

Parts Name	Restricted Substances					
	Pb	Hg	Cd	Cr	PBB	PBDE
Outer Panels	○	○	○	○	○	○
Circuit Board Assembly	×	○	○	○	○	○
Metal Work	×	○	○	○	○	○
Rubber Piece	○	○	○	○	○	○
Power Cable/ Power Adapter	×	○	○	○	○	○
Inner Signal Connecting Cable	○	○	○	○	○	○
Upholstery	○	○	○	○	○	○
<p>This form is made under the regulation of SJ/T 11364</p> <p>※ : Circuit Board Assemblies include the spare parts which make up a whole PCB, such as resistor, capacitor, integrated circuit, connectors, etc.</p> <p>○ : Indicates that the concentration of the hazardous substance in all homogeneous materials in the parts is below the relevant threshold of the GB/T26572 standard.</p> <p>× : Indicates that the concentration of the hazardous substance of at least one of all homogeneous materials in the parts is above the relevant threshold of the GB/T26572 standard.</p>						

Notes of environment-friendly lifetime



Lifetime of this electrical and electronic products, if operated as set forth in the manual, with the hazardous substance or element not to emit, neither to pollute the environment nor to cause harm to person or property, is limited to 10 years.



SAFETY INFORMATION

Safety Information

- ▶ Read all warnings carefully before use.
- ▶ Precautions and warnings listed below will help to ensure proper use of this appliance.
- ▶ The classes of accidents caused by incorrect use are classified into “WARNING” and “CAUTION”, Read all warnings below and follow all instructions within this manual.

 WARNING	Improper operation may cause injury to users.
 CAUTION	Improper operation may cause users injury or product damage.

 Prohibited	 No Disassemble
--	--

Not Suitable For Below Persons

We recommend that those with any of the following conditions should consult your physician before using.

 WARNING	<ul style="list-style-type: none"> ◆ Those who are using electronic medical instrument embedded in the body, such as cardiac pacemaker. ◆ Those undergoing treatment, especially those who are not feeling well. ◆ Those with malignant tumors or malignant abscesses.(Need to be supervised) ◆ Women who are pregnant or menstruating. ◆ Those with osteoporosis or fracture spine. ◆ Those with skin disease or those whose skins are injured. ◆ Those with high fever. ◆ Close supervision is necessary when this product is used by, on, or near children, invalids, or disabled persons.
--	---

Controller Precautions

 CAUTION	<ul style="list-style-type: none"> ◆ Do not operate the controller or pull the controller cable with damp hand. ◆ Do not spill water or other liquid onto the controller to avoid fault. ◆ Do not lay heavy staff on the controller.
--	---

Cautions Regarding The Ac Adapters And Ac Cord





 CAUTION	<ul style="list-style-type: none"> ◆ Check that the power voltage stated on the rating label corresponds to your local electricity supply. ◆ Do not use a damp hand to unplug the AC cord to avoid electric shock. ◆ Do not pull on the AC cord,reach to the front end to unplug it. ◆ Do not squeeze the AC cord by the appliance or other heavy objects. ◆ Do not damage,over bend , pull hard, twist or tie the power cord. ◆ If the supply cord is damaged, it must be replaced by the manufacturer or its service agent or a similarly qualified person in order to avoid a hazard.
--	--

SAFETY INFORMATION

Best Circumstances

 CAUTION	<ul style="list-style-type: none"> ◆ Do not use this appliance where temperature is over 40°C. ◆ Do not use this appliance in humid or dusty environment, or when any part of the body is in contact with plumbing or any similar ground. Keep the air openings free of lint, hair, and the like. ◆ Unplug from outlet during thunder or lightning storms, and before putting on or taking off parts. ◆ Do not use outdoors. ◆ Please place the product on the flat level floor. ◆ Do not store near heat or open flame.
---	--

Best Practices For Safe Use

 CAUTION	<ul style="list-style-type: none"> ◆ Only for users weighs below 120kg. ◆ Use this product only for its intended use as described in this manual. ◆ Do not use the product for therapeutic treatment purpose. ◆ Appliance should only be used by one person, do not use by two or more persons at the same time to avoid damage to the products. ◆ Do not use the product right after meal, it may cause discomfort. ◆ Remove the accessories from the arms and empty the pockets while use the massage services. ◆ Check the upholstery under the cushions and other spots, if any damages are present, do not use it and refer to a qualified service professional for servicing. ◆ If you feel any abnormal discomfort during the operation of this product, turn off the power immediately and do not use the product. ◆ Use the appliance for 20 minutes each time is highly recommended ◆ Make sure there is no obstacles behind the chair and there is enough clearance before adjusting the backrest or legrest angle. ◆ Make sure no other excessive load pressed on the backrest or legrest besides the user. ◆ Make sure there is no children, pets or other objects under the backrest or legrest. ◆ Please be seated properly while using the appliance. ◆ Do not drag or push the chair or roll on its caster on wood floor or carpet to avoid damage.
 PROHIBITED	<ul style="list-style-type: none"> ◆ Never operate this product if it has damaged /exposed parts or power leakage. ◆ Do not stand on or stack heavy objects on the footrest. ◆ Children should be supervised to ensure that they do not play with the massage chair. ◆ Do not fall into sleep while the product is operating. ◆ Avoid using the product under the influence of alcohol. ◆ Do not put hands or fingers in any openings of the appliance to avoid injury or damage to the appliance. ◆ If there is any smoke or unusual smell while using, stop using immediately, unplug the power cord.
 NO DISASSEMBLY	<ul style="list-style-type: none"> ◆ Do not disassemble this product yourself to avoid failure. ◆ Do not dismantle, fix or modify the yourself, Please contact authorized dealer or service agent.
 UNPLUG THE POWER CORD	<ul style="list-style-type: none"> ◆ Pull out the power cord from the power strips before maintenance. Never plug-in or pull out power cord with damp hand, to avoid shock or injury. ◆ Pull out the power cord from the power strips while not in use. ◆ Unplug from outlet when the power supply is cut, switch all controls to off.

PRODUCT SPECIFICATIONS

Product Name	: Deluxe Multi-function Massage Chair
Model Number	: RT-6602
Rated Voltage	: 220V~
Rated Frequency	: 50Hz
Rated Power	: 120W
Safety Design	: Class I

▶ TROUBLE SHOOTING

No.	Symptoms	Possible Causes	Possible Solutions
1	Shoo or clatter sound is heard	Normal working sound of motor or massage balls rubbing against the cloth cover	No need to take any measures
2	Appliance start failure	The power cord is not secured into the socket	Secure the Power plug
		Power switch is off	Turn on the switch
		The fuse is blown	Replace only with a fuse of same type and rating
3	No music from the speaker after the bluetooth is connected	The volume is turned to the lowest	Adjust the speaker volume from the mobile devices
4	Backrest or legrest can not raise or recline	Excessive load pressed on the backrest or legrest	Relieve the load and try again
5	Airbag malfunction	The air hose may be blocked	Straighten the air hose and clear out the blockage

If problem remains, please contact the dealer for maintenance.

Tips: Do not attempt to repair this product yourself, our company shall not be liable for the injury or damage caused by any servicing without authorization.

▶ NAME AND FUNCTION OF EACH COMPONENTS

External Structure

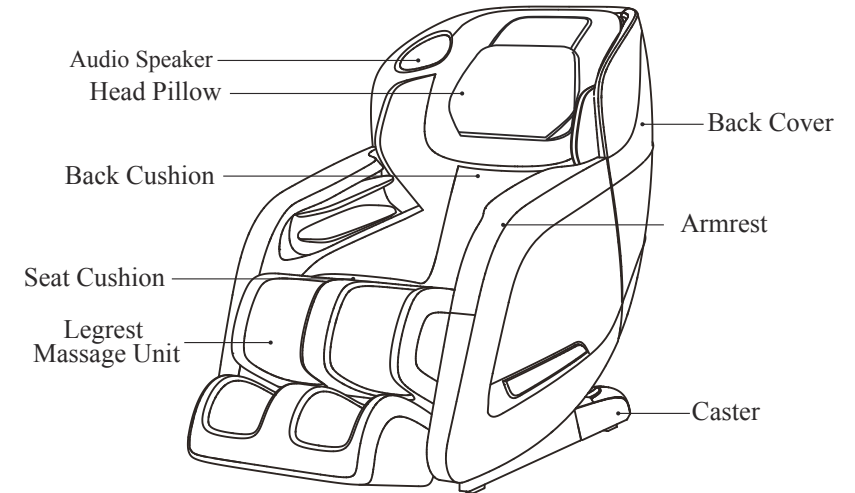

Internal Structure

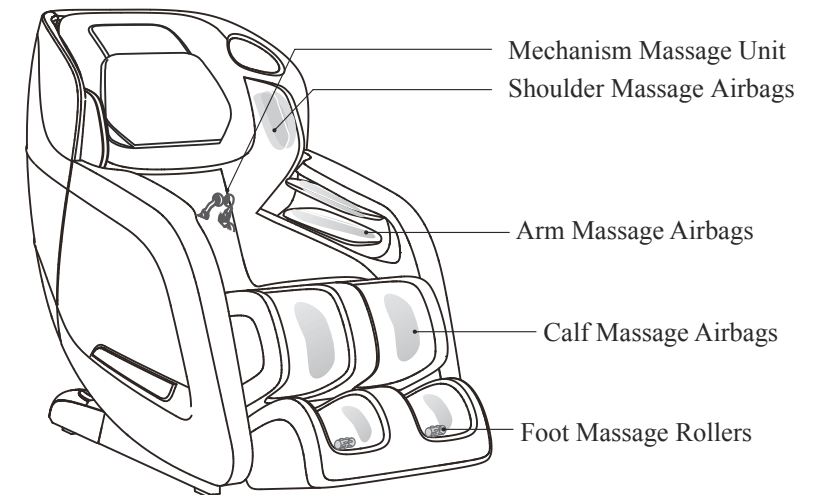

NAME AND FUNCTION OF EACH COMPONENTS

Power Box

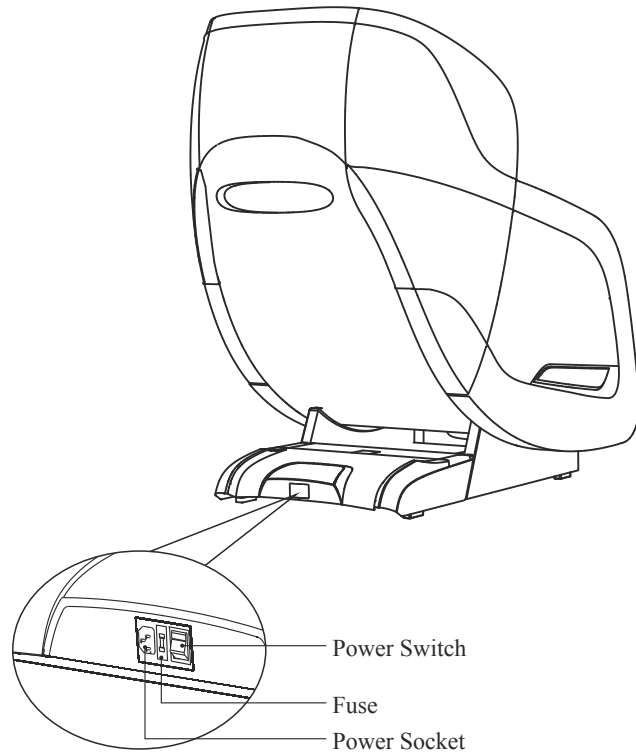

CAUTION

- ▶ Children should be supervised to ensure that they do not play with the massage chair to avoid accident.
- ▶ Always unplug the massage chair from the electrical outlet immediately after use.
- ▶ Unplug from outlet during thunder or lightening storms, and before putting on or taking off parts.
- ▶ Turn off the power switch and unplug the massage chair from the electrical outlet while not in use to avoid children start the massage chair accidentally.
- ▶ When not in use for a long period of time, we recommend that the chair be covered, the power cord be coiled and that the unit be placed in an environment free of dust and moisture.

CARE AND MAINTENANCE

Care and Maintenance Instructions

- ▶ To treat stains on back panel, armrest, footrest, plastic parts or air hose, spot clean with mild detergent foam, then wipe it with a dry cleaning cloth.
- ▶ To treat stains on controller, power box, spot clean with a dry cleaning cloth.
- ▶ To treat stains on back cushion or pillows, use a water-based upholstery cleaner only, wipe it with moist cloth, then air dry.
- ▶ To clean the foot/calf unit covers, remove it from the chair, hand wash with a mild detergent, then line dry.

CAUTION

- ▶ Pull out the power cord from the power strips before care and maintenance. To avoid electrical shock or injury, do not touch the power cord with wet hands. Make sure no detergent enter into the power box while cleaning.
- ▶ Do not use benzene, thinner or other solvents on your product, it may cause fading or damage to the product.
- ▶ Do not iron the upholstery.

Storage Methods

- ▶ Keep the product free from dust. Cover the product with a dust-free cloth to prevent collection of dust if not in use for a long period of time.

CAUTION

- ▶ Do not leave this product exposed to direct sunlight for long periods of time. This may cause fading or damage.

Warm Tips

- During daily use, please check for the following symptoms:
- ▶ Burnt smell.
 - ▶ The product experiences unusual power ON/OFF when touching the power cord.
 - ▶ Hot power cord.
 - ▶ Other abnormal symptoms.

CAUTION

- ▶ Please stop using the product to avoid breakdowns or accidents if any above symptom spotted.
- ▶ Switch off the power button and disconnect the plug, contact the local distributors or supplier for repair.
- ▶ All other servicing except above care and maintenance should be serviced by an authorized dealer or service center.

WARNING

Pull out the power cord from the power strips before care and maintenance. To avoid electrical shock or injury, do not touch the power cord with wet hands. Do not try to dismantle or repair the product yourself, please send your massage chair to the authorized service center.

PRELIMINARY CHECKS

Installation Site

Clearance Space for the massage chair:

- ▶ Make sure there is an adequate clearance for the massage chair installation. Please allocate a minimum 15 centimeter distance clearance for the back of the product. Please allocate a minimum 20 centimeter distance clearance for the front of the product.

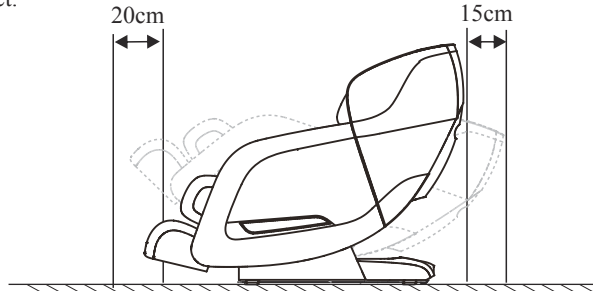

Floor Protection

- ▶ We recommend to place a piece of carpet or soft mat underneath it to avoid damaging the floor.

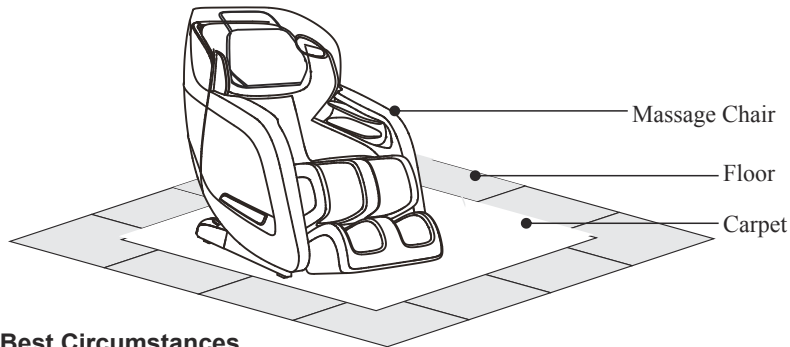

Best Circumstances

- ▶ Do not use the massage chair in high moisture environment to prevent electric shock accident.
- ▶ Please keep the massage chair away from heated surfaces to prevent fire hazard or damage to the product.



Grounding

- ▶ This product must be grounded, the plug must be plugged into an appropriate 3-wire grounded outlet that is properly installed and grounded in accordance with all local codes and ordinances to reduce risk of electrical shock.

NAME AND FUNCTION OF EACH COMPONENTS

Controller

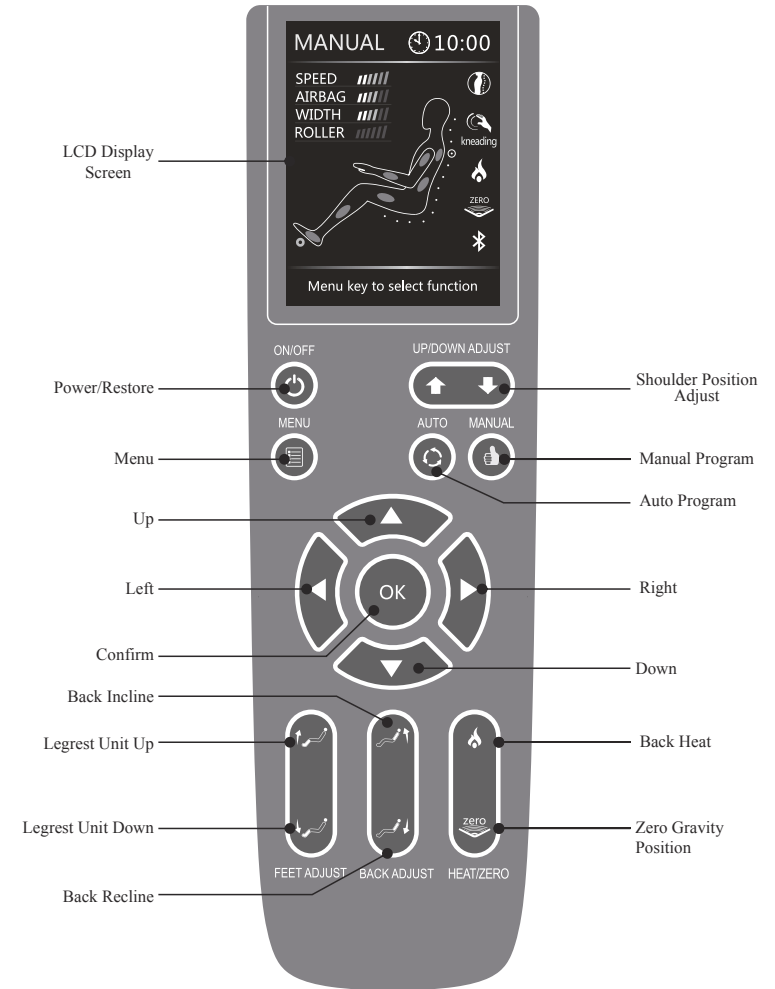

NAME AND FUNCTION OF EACH COMPONENTS

Instruction Of Controller



Power: Press this button to power on/off the remote.

- ▶ Press this button while connect to power to show the menu display, the LCD screen is lit, use the Up/Down/Left/Right buttons to navigate the screen, press OK to select.
- ▶ Press this button again to turn off the product.



Menu

- ▶ Display the Auto Program, Manual Program, Airbags, Heat, Roller and Setting function. (Check the Display Menu for detailed information)



Shoulder Position Adjust (slightly adjust mechanism up/down the shoulder)

- ▶ Press and hold on Shoulder Position Adjust button to adjust the rollers to the desired position while under manual program.
- ▶ Press and hold on Shoulder Position Adjust button to adjust the rollers to the desired position while under the body scan procedure.



Auto Program Button

- ▶ Display the Auto Program menu. when an auto program is running, press this button to toggle among the auto programs. the active program displays at the top of the status screen. (Check the Display Menu for detailed information.)



Manual Program Button

- ▶ Display the Manual Program Menu. Press this button to toggle among MODE, PART, WIDTH and SPED, you may choose a desired massage technique from 6 pre-set massage modes. (Check the Display Menu for detailed information)



Navigation

- ▶ Use the Up/Down/Left/Right buttons to navigate the screen, press OK to select.
- ▶ While Auto massage program is running, press Left/Right button to change the Airbag massage intensity.



Heat

- ▶ Turn on/off back heat function. Press this button to turn on back heat function, the heat icon on LCD display is lit; press this button again to turn off back heat function, the heat icon on LCD display turns to gray.



Turn on/off Zero Gravity Position.

- ▶ Press this button to turn on zero gravity position, the zero gravity icon on LCD display is lit; press this button again to turn off zero gravity position, the zero gravity icon on LCD display turns to gray.

PRELIMINARY CHECKS

Move Method

- ▶ Roll the chair on its casters to the desired location.
- ▶ Incline the backrest to upright position.
- ▶ Turn off the power switch and unplug the appliance from the electrical outlet.
- ▶ Using two people, push down on the backrest and lift up on the front side by grabbing the moving holder located to the front bottom of the armrest, roll the chair on its casters to the desired location (check the sketch for reference)

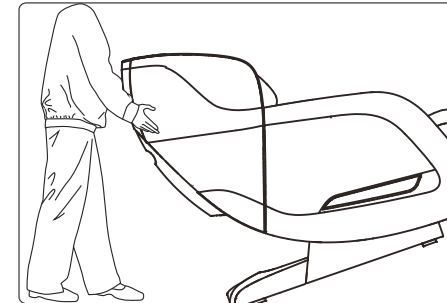

CAUTION

- ▶ Do not move the chair when there is user inside.
- ▶ To carry this product, do not lift by the footrest or armrest, hold the chassis and steady the backrest (have 4 or more people to carry the product).

Connect To Power

- ▶ Connect this appliance to a 3-wire properly grounded outlet.
- ▶ Turn on the main power switch located to the lower back of the right armrest.

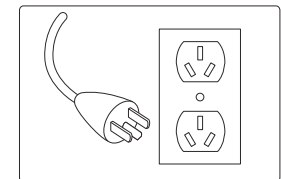

CAUTION

- ▶ Please verify that there is no damage to the supply cord before plug in.
- ▶ Please verify that the main power switch is turned off before connecting to power.

▶ PRELIMINARY CHECKS

- ▶ Connect the power cable to the product power socket located at the power box of the product.(Check below illustration for reference)

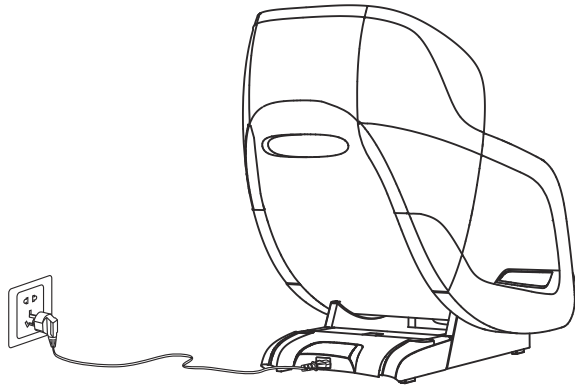

Commissioning

- ▶ Use the controller to recline the backrest to the ultimate angle, lift and extend the footrest to the maximum, make sure there is enough clearance before commissioning.
- ▶ Reset the chair after commissioning and turn off the power switch.
(To choose the massage program, please check the Instruction of Controller for reference)

Before Sitting

- ▶ Verify that the Legrest Massage Unit is well secured onto the main chair.
- ▶ Make sure all components is restored.if not,switch on the power and restore completely.

⚠ CAUTION

- ▶ Do not take seat while the legrest is lifted.
- ▶ Do not put excessive load on the legrest to avoid damage.

▶ NAME AND FUNCTION OF EACH COMPONENTS



Footrest Extend

- ▶ Press and hold to extend the footrest;release the button to stop.(Make sure there is no obstruction in advance)



Footrest Retract

- ▶ Press and hold to retract the footrest;release the button to stop.(Make sure there is no obstruction in advance)



Back Incline

- ▶ Press and hold to incline the backrest;Release the button to stop.

Back Recline

- ▶ Press and hold to recline the backrest,Release the button to stop.

Instruction of Display Screen Menu

▶ AUTO PROGRAM

Press to display the Auto Program menu,press this button to toggle among 9 Auto Program: RECOVERY,RXTEND,RELAX,REFRESH,UPPER AUTO,LOWER AUTO, BOSS NURSING,QUEEN SUMMING, SOUL SPA.Press OK to enter the program you desire.Selected program will show on the home screen.(Check below Menu photo for reference)

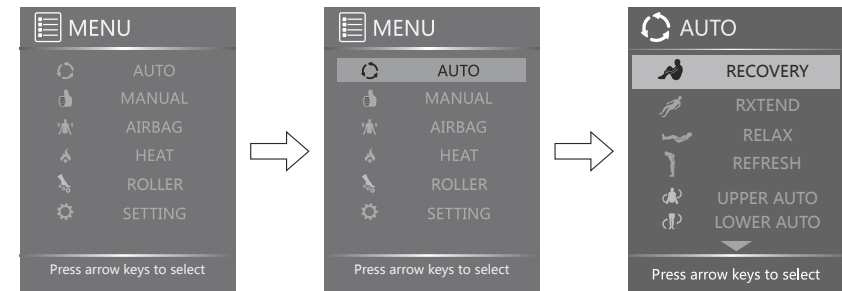

Recovery:Designed for after work recovery,it helps to release the fatigue and speed recovery.

Extend:Inspired by Thai style massage,featured in extension and stretching,this massage program uses strong kneading and stretching techniques to relax tired muscles and keep them flexible.

Relax:Designed for morning or midday relaxation,it helps to boost the viability of muscles.

▶ NAME AND FUNCTION OF EACH COMPONENTS

Refresh: Focusing on tight and sore muscles, it helps to relieve waist, back and neck pain.

Lower Auto/Lower Auto: Choose the target zone as desired.

Boss Nursing: Delivers an intense massage focusing on relieving sore and tension in the neck and shoulders, bringing utmost relief and comfort for users who spend long hours at desk.

Queen Slimming: Adopts mild massage techniques to relax muscles in the back and waist, helping to shape body figure and promote metabolism.

Soul Spa: Designed for morning or midday relaxing, it helps to boost the viability of muscles.

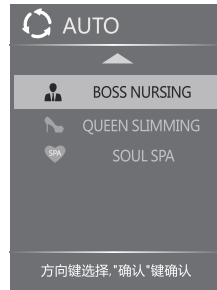

▶ MANUAL PROGRAM

Press MANUAL from MENU display, press Up or Down button to navigate among: MODE, PART, WIDTH, SPEED.

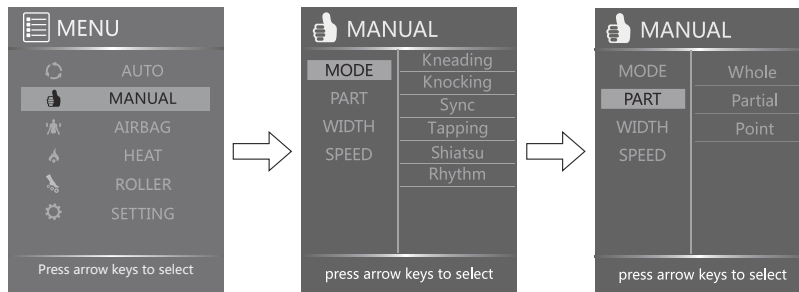

Massage Mode: Press MODE from MANUAL display, press Right button then press UP or DOWN button to navigate among: Kneading, Knocking, Sync, Tapping, Shiatsu, and Rhythm massage techniques. Press OK button to enter the setting you desire. Selected mode will show on the home screen.

Back Mechanism Massage Part: Press PART from MANUAL display, press Right button then press Up or Down button to navigate among: Whole, Partial and Point massage zones. Press OK button to enter the setting you desire. Selected setting will show on the home screen.

▶ PRELIMINARY CHECKS

Installation Method

Step 1: Take all massage chair units out of the cartons

- ▶ Unpack the cartons: take out all upholstery unit, accessories out of the cartons.
- ▶ Before beginning installation, please verify that all components are included (check with the packing list carefully)

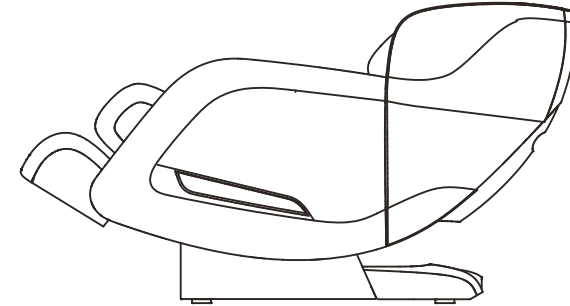

Step 2: Install the controller unit

- ▶ Take the controller unit out of the accessories box; Connect the data line of the controller to the port to the lower inner side of the right armrest (pay attention to the convex and concave of the connector and port), then tighten the screw cap clockwise. (Check the illustration below for reference)

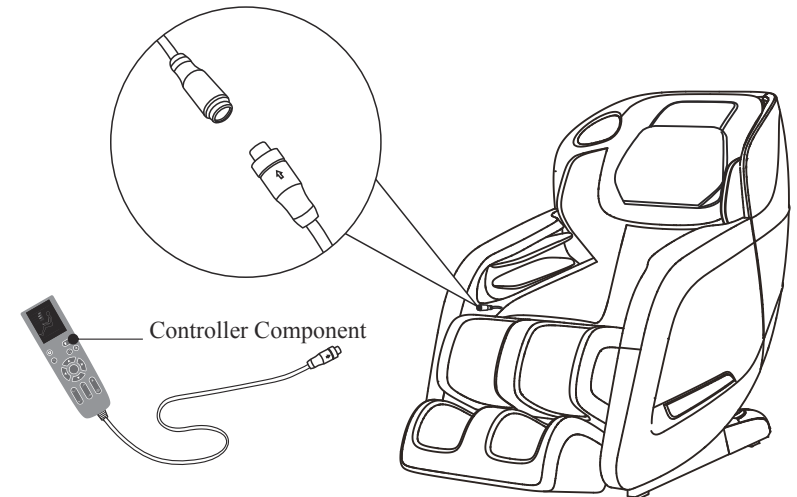

PRELIMINARY CHECKS

Tips:

1. In the process of Auto or Manual Setting, LCD screen will auto revert back to the homescreen after 10 seconds if there is no operation entered into the remote control.

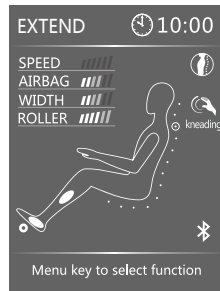

Homescreen Display With The Auto Program Running

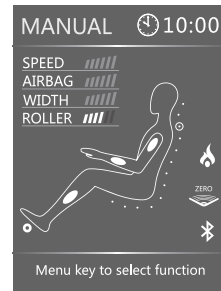

Homescreen Display With The Manual Program Running

TIPS

- ▶ While appliance is running. press twice MENU button to revert to homescreen.
- ▶ Under the homescreen display, press Left or Right button to adjust the airbag intensity (works in the process of both Auto and Manual program);
- ▶ Press Auto button to select auto massage program.

CAUTION

- ▶ Do not disassemble this product yourself to avoid product failure.
- ▶ Make sure no water or other liquid enters into the controller to avoid fault.
- ▶ Do not pinch or squeeze the controller or power cord.

NAME AND FUNCTION OF EACH COMPONENTS

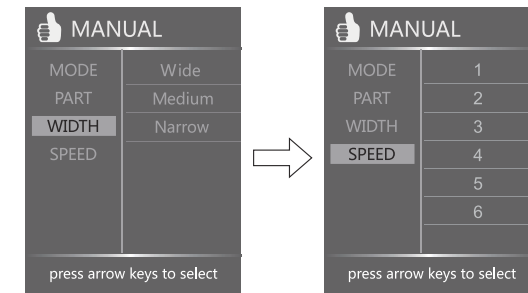

Back Mechanism Massage Width: Press WIDTH from MANUAL display, press RIGHT button then press Up or Down button to navigate among: Width, Medium and Narrow mechanism roller width. Press OK button to enter the setting you desire. Selected width will show on the home screen.

Mechanism Massage Speed: Press Speed from MANUAL display, press Right button then press Up or Down button to navigate among: level 1,2,3,4,5,6 Mechanism massage intensity. Press OK button to enter the intensity level you desire.

AIRBAGS

Press AIRBAG from MENU display to show the AIRBAG display, press Right button then press Up or Down button to navigate between: PART-Air pressure region and Force-Air pressure intensity, Press OK button to enter the setting you desire.

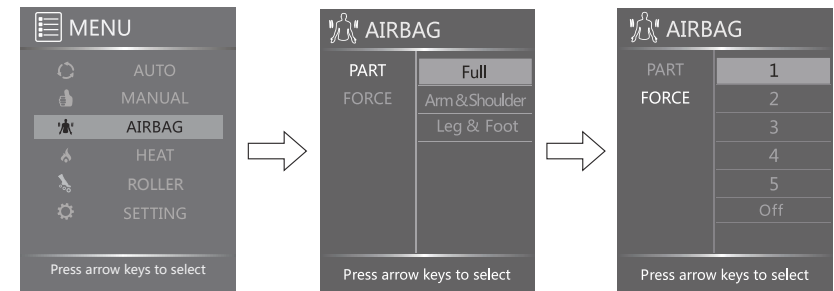

Part-Air pressure region: Press PART from AIRBAG display, press Right button then press Up or Down button to navigate among: Full, Arm & Shoulder, Leg & Foot, airbag positions. Press OK button to enter the airbag position you desire.

Force-Air pressure intensity: Press FORCE from AIRBAG display, press Right button then press Up or Down button to navigate among: level 1,2,3,4,5 airbag intensity, or OFF (deactivate airbag intensity function), Press OK button to enter the airbag setting you desire.

NAME AND FUNCTION OF EACH COMPONENTS

►HEAT

Press HEAT from MENU display,then press Up or Down button to turn on or off back heat function.

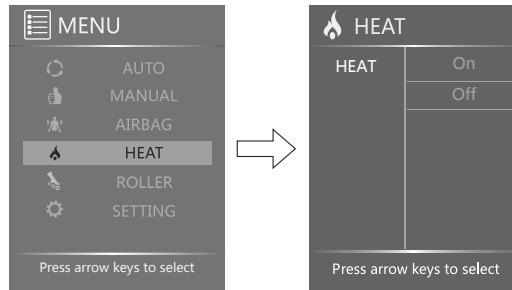

►ROLLER

Press ROLLER from Menu Display,then press Up or Down button to toggle among speed level 1,2,3 and off.

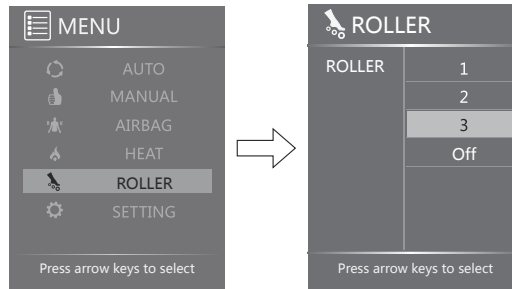

► SETTINGS

Press SETTING from MANUAL display,press OK button to enter SETTING display,Then press Up or Down button to navigate among:TIME,LANGUAGE, BLUETOOTH.Press OK button to enter the setting you desire.

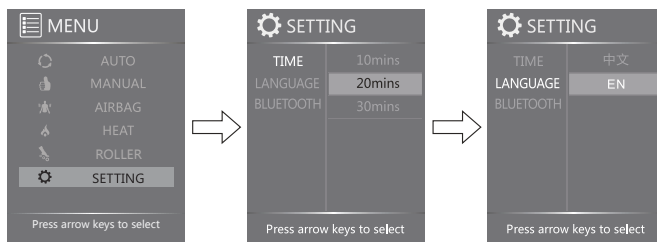

PRELIMINARY CHECKS

Time:

Press TIME from SETTING to show available timer: 10min,20min,30min. press Right button then press Up or Down button to navigate,press OK button to enter the timer you desire.

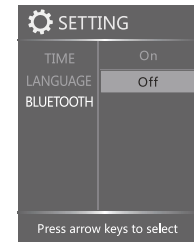

Language:

Press LANGUAGE from SETTING to show available language:中文,EN,press Right button then press Up or Down button to navigate,press OK button to enter the language you desire.

Bluetooth:

From BLUETOOTH,press Right button then press Up or Down button to activate or deactivate Bluetooth function. press OK button to enter the setting you desire.

Notes: All Settings listed above will be memorized and no need to set again with power failure.

APP DOWNLOAD AND INSTALLATION

Download app and control the chair from an Android or iOS device,below is the instructions:

► For an iOS device:

Open the App Store on your iOS device (iPhone, iPad, or iPod touch),use keyword “RT6602” to search,download it to your device and have it set up.while setup completed,open it and switch the Blue Tooth to “ON”,pair it with the massage chair. (Note:Version of iOS device need to be above 4.0)

► For an Android device:

Supplier will email the app to customer,download it to your device and have it set up.while setup completed,open it and switch the Blue Tooth to “ON”,pair it with the massage chair.

(Note:Version of Android device need to be above 5.0 and with Blue Tooth function)



CAUTION

► While pairing your mobile device with the massage chair,please verify that the massage chair and the blue tooth is set to “ON”.