

Owner's Manual & Safety Instructions

Save This Manual Keep this manual for the safety warnings and precautions, assembly, operating, inspection, maintenance and cleaning procedures. Write the product's serial number in the back of the manual near the assembly diagram (or month and year of purchase if product has no number). Keep this manual and the receipt in a safe and dry place for future reference.

20g

Greenhouse

16' L x 10' W x 10'3" H

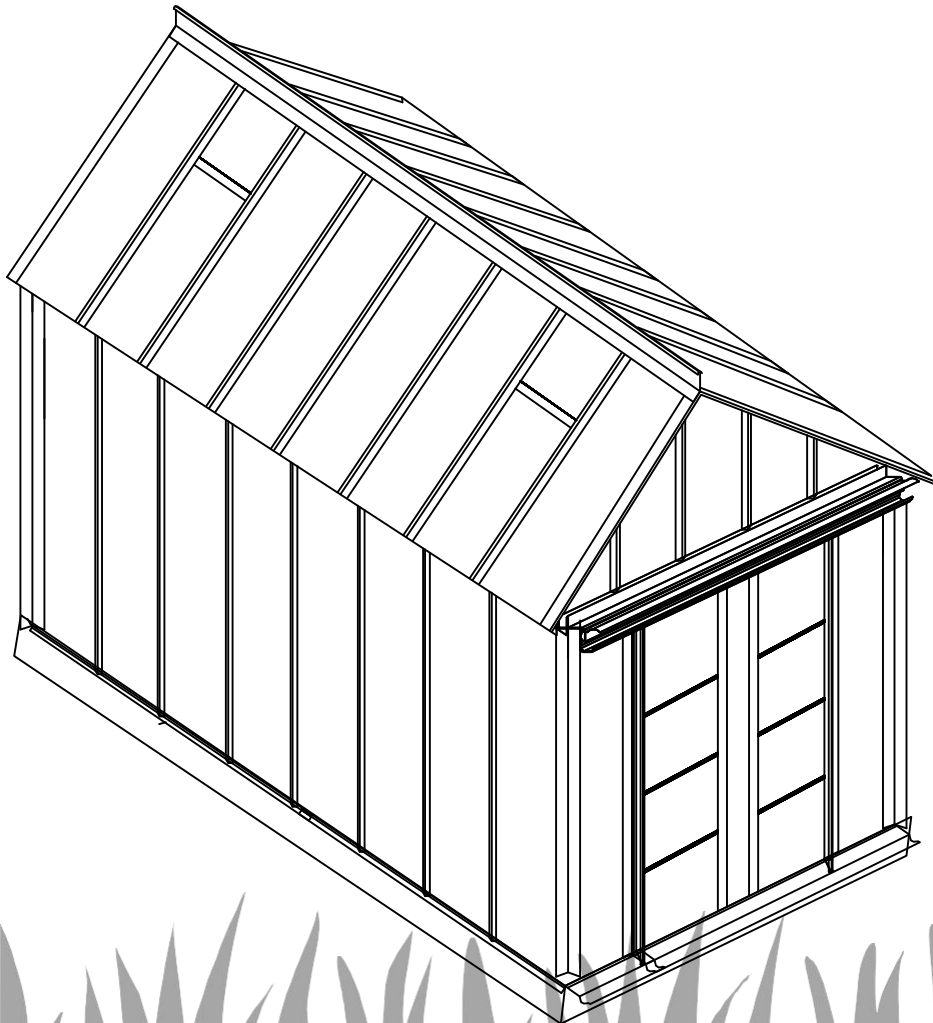

Shelving unit and pots not included.

93358

When unpacking, make sure that the product is intact and undamaged. If any parts are missing or broken, contact us as soon as possible.





No portion of this manual or any artwork contained herein may be reproduced in any shape or form without the express written consent of Harbor Freight Tools. Diagrams within this manual may not be drawn proportionally. Due to continuing improvements, actual product may differ slightly from the product described herein. Tools required for assembly and service may not be included.

⚠️ WARNING

Read this material before using this product. Failure to do so can result in serious injury. **SAVE THIS MANUAL.**

Table of Contents

Safety.....	3	Parts List.....	6
Specifications.....	4	Maintenance.....	31
Assembly.....	5	Warranty.....	32

WARNING SYMBOLS AND DEFINITIONS	
	<p>This is the safety alert symbol. It is used to alert you to potential personal injury hazards. Obey all safety messages that follow this symbol to avoid possible injury or death.</p>
 DANGER	<p>Indicates a hazardous situation which, if not avoided, will result in death or serious injury.</p>
 WARNING	<p>Indicates a hazardous situation which, if not avoided, could result in death or serious injury.</p>
 CAUTION	<p>Indicates a hazardous situation which, if not avoided, could result in minor or moderate injury.</p>
<div style="background-color: black; color: white; padding: 2px 5px;">NOTICE</div> <div style="background-color: #cccccc; padding: 2px 5px;">CAUTION</div>	<p>Addresses practices not related to personal injury.</p>

IMPORTANT SAFETY INFORMATION

The warnings, precautions, and instructions discussed in this manual cannot cover all possible conditions and situations that may occur. The operator must understand that common sense and caution are factors, which cannot be built into this product, but must be supplied by the operator.

Assembly / Installation Precautions

1. Assemble only according to these instructions. Improper assembly can create hazards.
2. Wear ANSI-approved safety goggles and heavy-duty work gloves during assembly.
3. This unit contains pieces with sharp edges. The machined edges of the aluminum parts and the ends of the panel clips may be sharp. Handle all parts carefully.
4. Keep assembly area clean and well lit.
5. Keep bystanders out of the area during assembly.
6. Do not assemble when tired or when under the influence of alcohol, drugs or medication.
7. Product capabilities apply to properly and completely assembled product only.
8. Locate the Greenhouse on a flat level surface. A concrete foundation is recommended for a high-quality installation.

Use / Service Precautions

1. **This product is not a toy. Do not allow children to play in or climb on this product.** Although this greenhouse does include some caps, there are still some exposed sharp edges. In addition, protective covers may fall off in time. Children must be supervised if allowed near the greenhouse.
2. **SNOW/DEBRIS ACCUMULATION HAZARD.** The heavy weight of accumulated snow or other debris can cause parts of this greenhouse to buckle suddenly. Do not allow debris to accumulate on top of the greenhouse. If snowfall is expected, place additional supports (not provided) underneath the Crown. **NEVER enter a greenhouse with accumulated debris on top.**
3. Use as intended only.
4. Inspect periodically; replace damaged parts immediately and do not enter greenhouse if parts are loose or damaged.
5. For your safety, service and maintenance should be performed regularly by a qualified technician.



SAVE THESE INSTRUCTIONS.

Specifications

Overall Dimensions	16' L x 10' W x 10'3" H
Window Dimensions	23-1/4" W x 31-1/4" L
Door Dimensions	75-1/2" H x 35-1/2" W x 1-1/4" Thick
Materials	Aluminum Frame Transparent Polycarbonate Sheets
Aluminum Thickness	0.038"
Polycarbonate Sheet Thickness	0.165"



Read the ENTIRE IMPORTANT SAFETY INFORMATION section at the beginning of this document including all text under subheadings therein before set up or use of this product.

IMPORTANT—READ THE FOLLOWING CAREFULLY BEFORE PROCEEDING

- The first step in assembly is to assemble a proper base. The greenhouse must be properly supported to help prevent property damage and injury in the event of strong winds or inclement weather. Wind and ground conditions may vary from site to site, and may affect the practicality and effectiveness of anchoring methods substantially. If you have any doubt regarding the stability of the base/foundation you are to use, consult a professional.
- It is always your responsibility to ensure that the greenhouse is properly anchored. The manufacturer and distributor cannot be held responsible for personal injury, damage to the greenhouse, or other property damage that occurs as a result of improperly anchoring the greenhouse.
- Be certain to check with local authorities to obtain all required building permits and to familiarize yourself with any building codes that may apply.
- Decide on a location for the greenhouse. The location should optimally be a level, well-lit area that is sheltered from the wind. The door of the greenhouse should not open towards the prevailing wind, if possible.

IMPORTANT ASSEMBLY TIPS















- Assemble Bolts with their heads facing the outside of the greenhouse, unless stated otherwise. Tighten Nuts (54) only about 1/4 turn past finger-tight; be careful not to overtighten.
- Lay out all parts by number prior to assembly.
- At least two assistants will be necessary during assembly.
- Assemble on a clear, calm day. Wind will damage the Greenhouse and make assembly difficult.
- Ladders and gloves may need to be used(not included).





















PLEASE READ THE FOLLOWING CAREFULLY











THE MANUFACTURER AND/OR DISTRIBUTOR HAS PROVIDED THE PARTS LISTS IN THIS DOCUMENT AS A REFERENCE TOOL ONLY. NEITHER THE MANUFACTURER OR DISTRIBUTOR MAKES ANY REPRESENTATION OR WARRANTY OF ANY KIND TO THE BUYER THAT HE OR SHE IS QUALIFIED TO MAKE ANY REPAIRS TO THE PRODUCT, OR THAT HE OR SHE IS QUALIFIED TO REPLACE ANY PARTS OF THE PRODUCT. IN FACT, THE MANUFACTURER AND/OR DISTRIBUTOR EXPRESSLY STATES THAT ALL REPAIRS AND PARTS REPLACEMENTS SHOULD BE UNDERTAKEN BY CERTIFIED AND LICENSED TECHNICIANS, AND NOT BY THE BUYER. THE BUYER ASSUMES ALL RISK AND LIABILITY ARISING OUT OF HIS OR HER REPAIRS TO THE ORIGINAL PRODUCT OR REPLACEMENT PARTS THERETO, OR ARISING OUT OF HIS OR HER INSTALLATION OF REPLACEMENT PARTS THERETO.











Parts List A

Lengths given are rounded to the nearest inch. Hardware lengths are approximate.

PART	DESCRIPTION			QTY
1a	Front-Left Floor Plate	2' 7"		1
2a	Front-Right Floor Plate	7' 2"		1
3	Upper Side Floor Plate	7' 11"		2
4	Side Floor Plate	7' 11"		2
5	Rear-Left Floor Plate	4' 9"		1
6	Rear-Right Floor Plate	4' 9"		1
7	Corner Post	6' 5"		4
8	Right-handed Crown Beam	6'		2
9	Left-handed Crown Beam	6'		2
10	Rear Crown with Brackets	7' 8"		1
11	Front Crown	7' 9"		1
12	Side Ceiling Plate with Brackets	7' 9"		2
13	Plain Side Ceiling Plate	7' 8"		2
14	Side Post	6' 4"		18
15	Rafter	5' 1 2"		14
16	Rear-Left Post	1' 3"		1
17	Rear-Right Post	1' 3"		1
18	Rear-Left Gable Post	2' 6"		1
19	Rear-Right Gable Post	2' 6"		1
20	Front Center-Left Gable Post	2' 6"		1
21	Front Center-Right Gable Post	2' 6"		1
22	Front-Left Gable Post	1' 4"		1
23	Front-Right Gable Post	1' 4"		1







PART	DESCRIPTION			QTY
24	Front-Left Ceiling Plate	7' 4"		1
25	Front-Right Ceiling Plate	2' 2"		1
26	Left Door Rail	4' 8"		1
27	Right Door Rail	4' 8"		1
28	Left Doorway Post	6' 5"		1
29	Right Doorway Post	6' 5"		1
30	Side Brace	7' 7"		12
31	Rear Brace	5' 8"		6
32	Front Brace	1' 9"		4
33	Side Door Frame	6' 2"		4
34	Door Slider	2' 8"		2
35	Top Door Frame	2' 8"		2
36	Center Door Frame	2' 8"		6
37	Bottom Door Frame	2' 8"		2
38	Top Window Frame	1' 9"		4
39	Side Window Frame	2' 4"		8
40	Bottom Window Frame	1' 9"		4
41	Window Support Beam	2'		4
42	Panel Connector			5
43	End Cap			16
44	Brace	5' 8"		6
45	Front/Rear Diagonal Strut	6' 5"		4
46	Side Diagonal Strut	7' 5"		4







80	Side Base Plate	3' 1 0 "		2
47	Hold-down Connector			32
48	Post Connector			4
49	Corner Bracket			4
50	Door Bottom Slider			4
51	Panel Clip			178
52	Normal Bolt	M6 x 3/8"		363
53	Brace Bolt	M6 x3/4"		154
54	Nut			523
55	Phillips Screwdriver			1

56	Door Screw	4.3 x 4/5"		40
57	Side fixtures			14
58	Angle fixtures			4
59	Tapping Screw	4.3 x 1/2"		100
60	Left Rail End Cap			1
61	Right Rail End Cap			1
62	Wrench			1
63	Cocket Wrench			1
64	Double Brace Bolt	M6 x 1"		6
65	Bushing	Ø.5" x0.4"		4

Parts List B

Lengths given are rounded to the nearest inch. Hardware lengths are approximate.

PART	DESCRIPTION		QTY
66	Side Base Plate	5' 9 "	 4
67	Front/Rear Base Plate	4' 9 "	 4
68	Base Plate Corner Connector		 4
69	Base Plate End Connector		 6
70	Front/Rear Top Panel	1' 9" x 2' 6"	 4
71	Front/Rear Center Panel	1' 9" x3' 2"	 2
72	Wall Panel	1' 9" x 6' 5"	 21

PART	DESCRIPTION		QTY
73	Roof Window Panel	1' 11" x 3' 7"	 4
74	Roof Panel	1' 9" x 5'12"	 12
75	Window Pane	1' 9" x 2' 6"	 4
76	Front Corner Panel	1' 9" x 1' 3"	 4
77	Front Side Panel	2' x 6' 4"	 2
78	Door Panel	1' 4" x 2' 9"	 8

Record Serial Number here: _____



Note: If product has no serial number, record month and year of purchase instead.

Note: Some parts are listed and shown for illustration purposes only, and are not available individually as replacement parts. Specify UPC 193175344700 when ordering parts.

Phase 1: Base Assembly

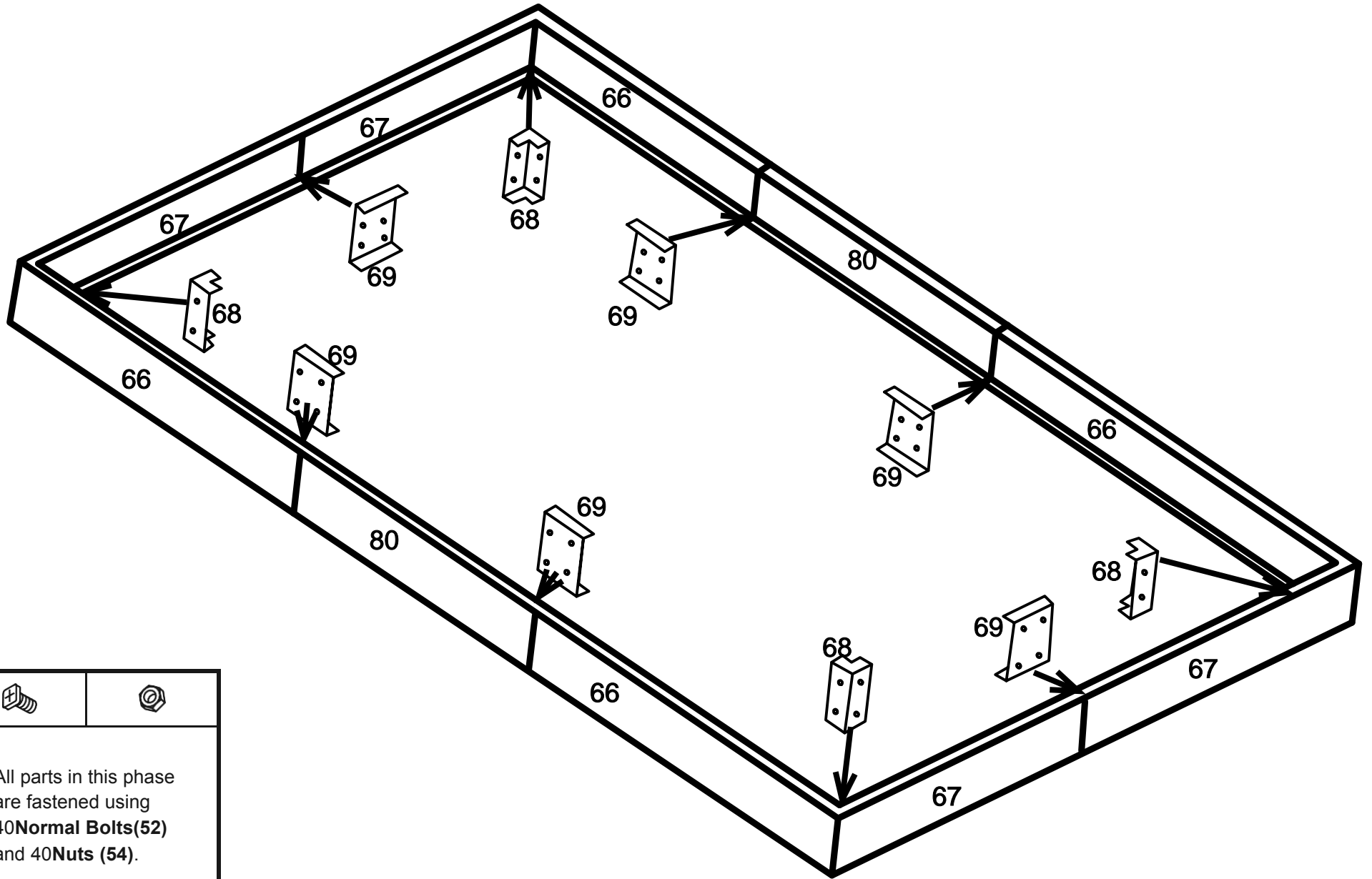
For technical questions, contact us.



	
<p>All parts in this phase are fastened using 40Normal Bolts(52) and 40Nuts (54).</p>	

Base Assembly Instructions

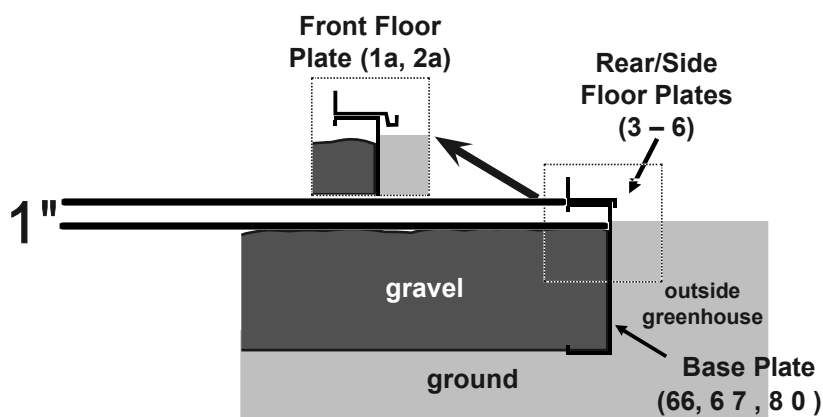

1. Excavate an area for the base of the greenhouse. The area must be 10' 2" wide by 16' 2" long by 5" deep. The floor of the hole must be level and square. The diagonal dimensions, from corner to corner, should each be 18' 10".
2. Assemble the Base outside the hole as shown on facing page. Note that the angled edges of the Base Plates (66,67 , 80) need to face the corners of the base. Use Normal Bolts (52), Nuts (54), and Connectors (68, 69) to secure the pieces together.
3. With assistance, lower the Base into the hole. The diagonal dimensions, from outside corner to outside corner, must be equal for the base to be square.
4. Fill the hole around the outside of the base with soil.
5. This base will need to be filled with about 40 cubic feet of gravel or another appropriate fill material (not provided). The gravel should reach up to about 1" below the lip of the base.

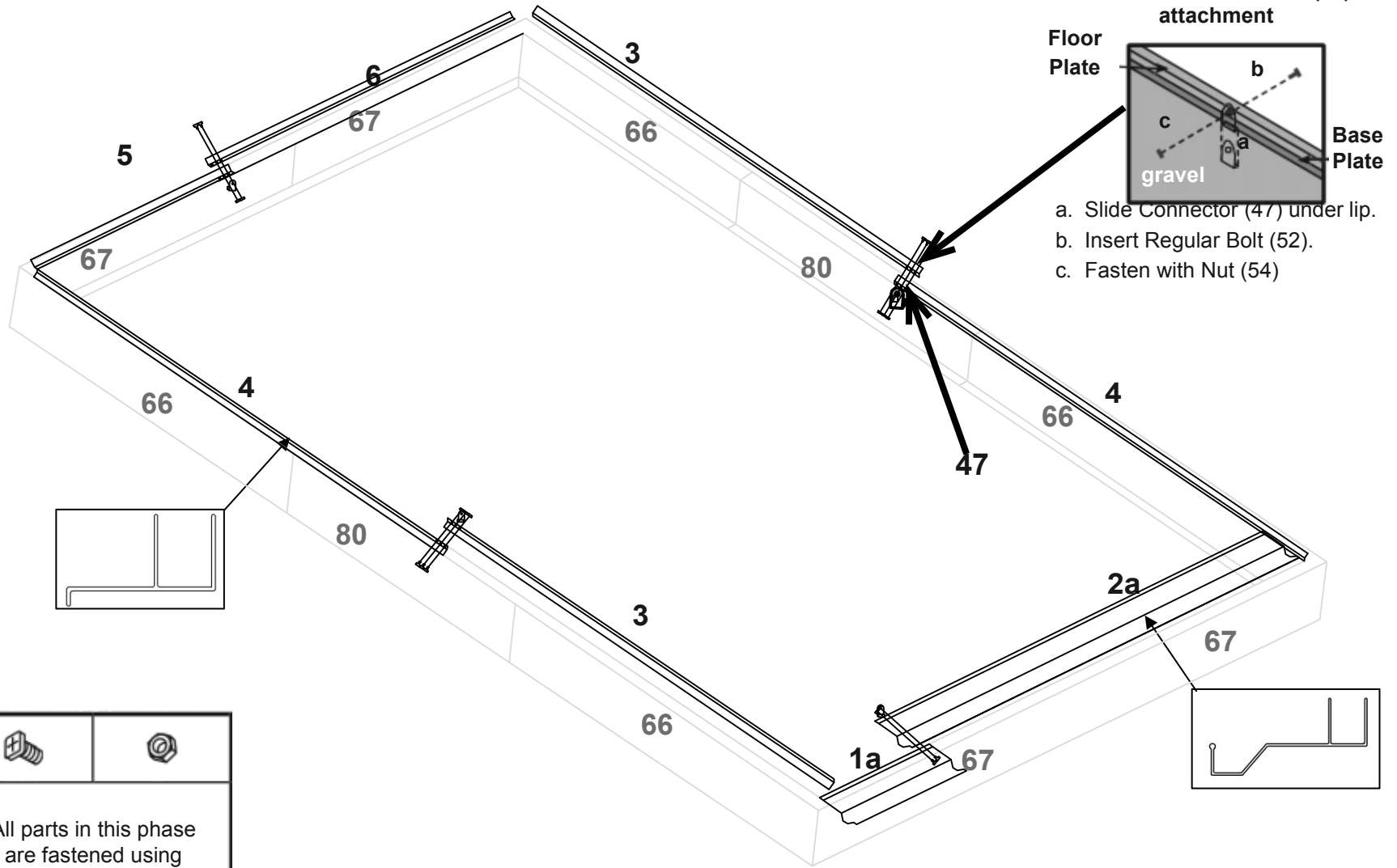

Phase 2: Floor Plate Installation

Grey parts are in place before this phase.



	
<p>All parts in this phase are fastened using 10 Normal Bolts (52) and 10 Nuts (54).</p>	

Floor Plate Installation Instructions

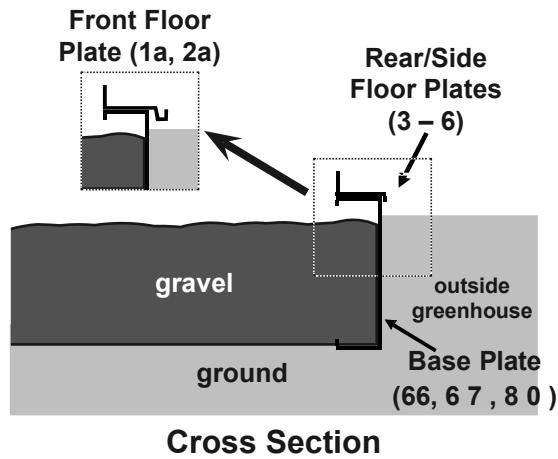

1. When placing the Floor Plates (1a–6) on top of the Base Plates (66, 67, 80) align them as illustrated above. The lip should extend slightly over the edge of the Base Plate and the raised flange with bolt holes should face inside the greenhouse.
2. Place the Front-Left Floor Plate (1a) on top of the Base Plate (67). Lay the Front-Right Floor Plate (2a) on top of it and line up the two holes where the Plates overlap.
3. Fasten the Front Floor Plates (1a, 2a) together, and secure to the Base Plate (67) using a Hold-down Connector (47) over one of the Bolts (52); see inset on facing page.
4. Place the Side Floor Plates (4) on the Side Base Plates (66) on the front-right and rear left corners as illustrated. Lay the Upper Side Floor Plates (3) on top so that the three holes line up where the Plates overlap.
5. Fasten the Side Floor Plates (3, 4) together, and secure to the Base Plates (66) using three Hold-down Connectors (47) on each side of the greenhouse in the places illustrated; see illustration and inset on facing page.
6. Lay the Rear-right Floor Plate (6) on top of the Rear-left Floor Plate (5) so that the two holes line up where the Plates overlap. Fasten the Rear Floor Plates (5, 6) together through those holes.
7. Place the assembled Rear Floor Plates on top of the Base Plates (67).
8. Secure the Rear Floor Plates to the Base Plates using two Hold-down Connectors (47) in the locations shown; see illustration and inset on facing page.

Phase 3: Corner Post Installation

Grey parts are in place before this phase.

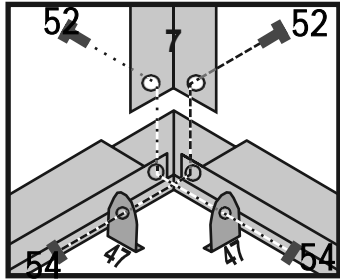

**Hold-down Connector (47)
attachment with Strut (45, 46)**

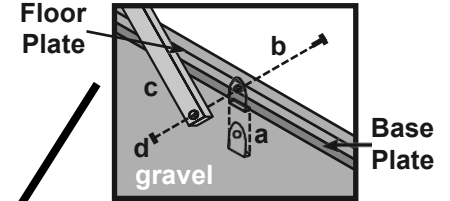

- a. Slide Connector (47) under lip.
- b. Insert Brace Bolt (53).
- c. Slide Strut (45, 46) over Bolt.
- d. Fasten with Nut (54)

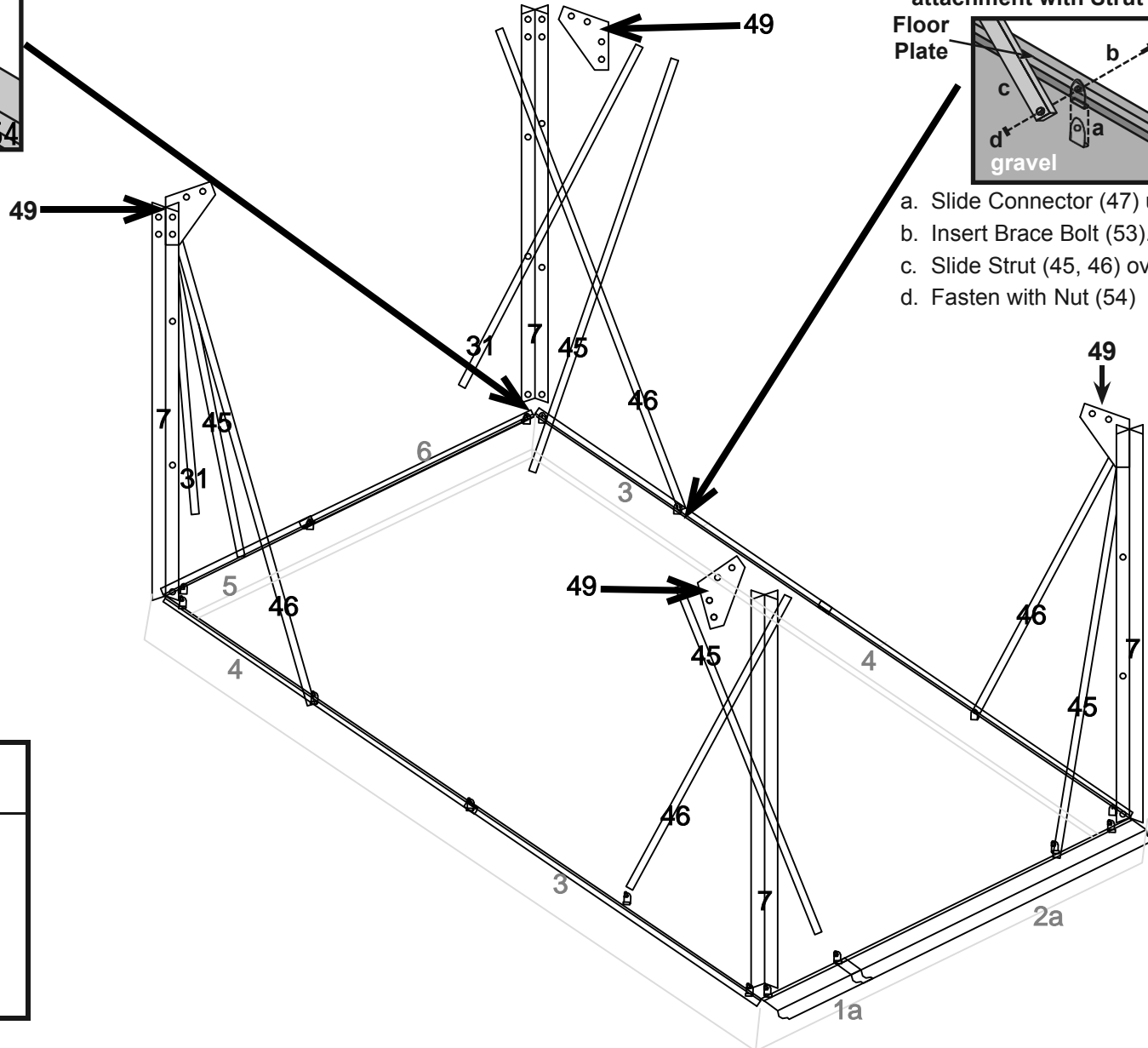

<p>Parts in this phase are fastened using 10 Normal Bolts (52), 14 Brace Bolts (53), 2 Double Brace Bolts (64), and 26 Nuts (54).</p>			

Corner Post Installation Instructions

1. There are 4 Corner Posts (7) to be attached to the Floor Plates (1a-6). The end with two holes should be at the bottom, as shown in the illustration in the center of this page.

2. Attach one Corner Post (7) on the outside of the right rear Floor Plates (3, 6) using two Normal Bolts (52), two Hold-down Connectors (47), and two Nuts (54); see inset on facing page.

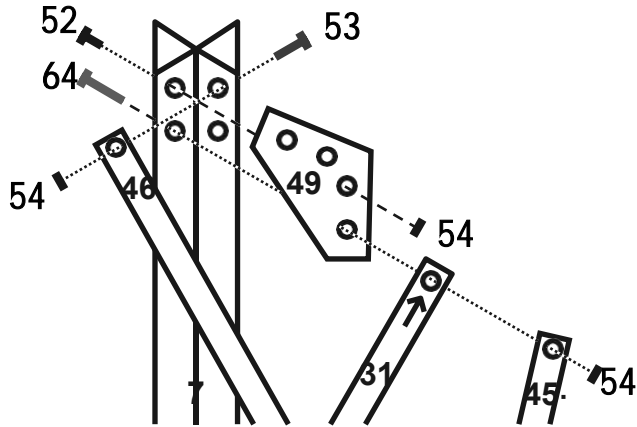

3. Fasten a Corner Bracket (49) to the top of the Corner Post (7) over the Rear Floor Plate (6) using one Normal Bolt (52) for now. Install it angled up towards the center of the greenhouse, as shown above.

4. Install a Double Brace Bolt (64) through the bottom hole of the Corner Bracket. Place a Rear Brace (31) over it with the arrow pointing towards the Bolt. Also place Front/Rear Diagonal Strut (45) over the Bolt, and thread on Nut (54) hand-tight.

5. Fasten a Side Diagonal Strut (46) to the free top hole on the Corner Post (7) using Brace Bolt (53) and Nut (54).

6. Fasten Struts (45, 46) to Floor Plates using Brace Bolts (53), Hold-down Connectors (47), and Nuts (54); see inset on facing page. Allow Rear Braces to hang free.

7. Repeat steps 2 through 6 for the left rear Corner Post (7) on the left side. Keep in mind that the connections will be reversed compared to the right side.

8. Attach one Corner Post (7) on the outside of the front left Floor Plates (1a, 3) using two Normal Bolts (52), two Hold-down Connectors (47), and two Nuts (54).

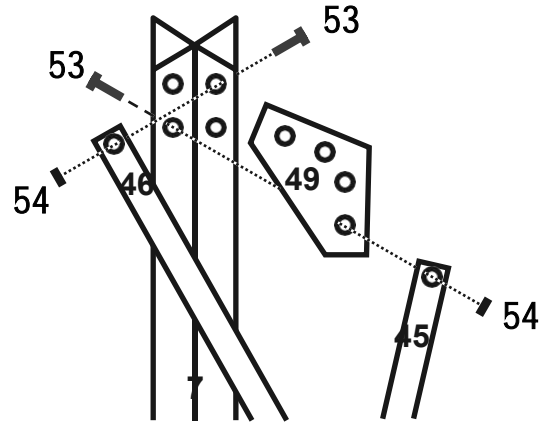

9. Insert a Brace Bolt (53) through the second hole from the top of the Corner Post (7) over the Front Floor Plate (1a). Place the bottom hole of the Corner Bracket (49) over the Bolt with it angled up towards the center of the greenhouse, as shown above. Secure it using a Nut (54).

10. Fasten a Side Diagonal Strut (46) to the top hole on the Corner Post (7) over the Side Floor Plate using a Brace Bolt (53) and Nut (54).

11. Secure the Struts (45, 46) to the Floor Plates using Brace Bolts (53), Hold-down Connectors (47), and Nuts (54); see inset on facing page.

12. Repeat steps 8 through 11 for the right front Corner Post (7) on the right side. Keep in mind that the connections will be reversed compared to the left side.



Phase 4a: Ceiling Plate Assembly, Front

1. Insert Normal Bolts (52) through all holes in the front of the Front Ceiling Plates (24, 25), as shown. Thread a Nut (54) onto each Bolt, but leave all Nuts loose for now.

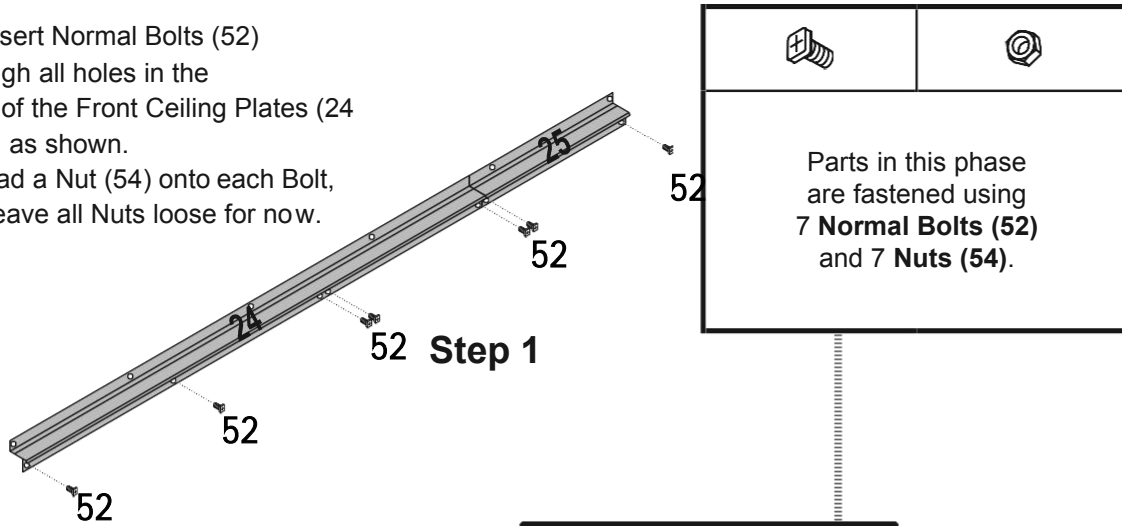

3. Slide the Bolt heads on the Front-left Ceiling Plat (24) into the slot of the Right Door Rail (27) from the left edge until it rests against the Front-right Ceiling Plate (25). Tighten the 2 right-most Nuts on the Ceiling Plate.

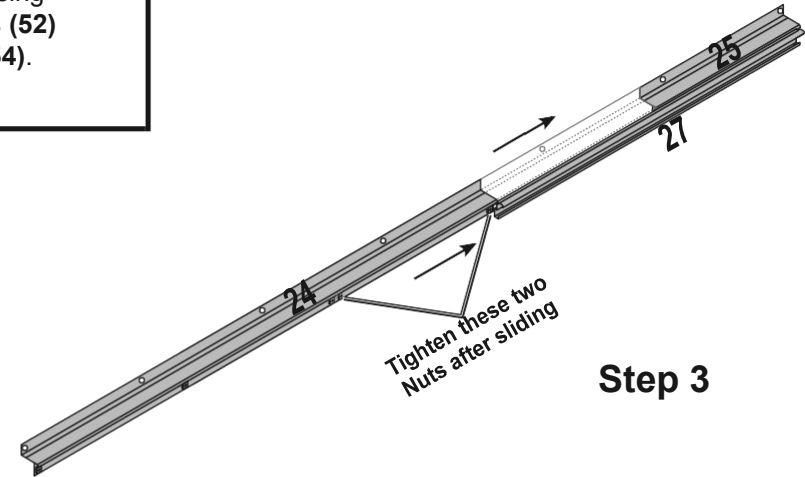

2. Slide the slot on the Right Door Rail (27) over the heads of the 2 Bolts on the Front-right Ceiling Plate (25) until the right end is flush, as shown. The illustration in the center of this page shows how to slide the Rail over the Bolt heads. Tighten the Nuts on those 2 Bolts.

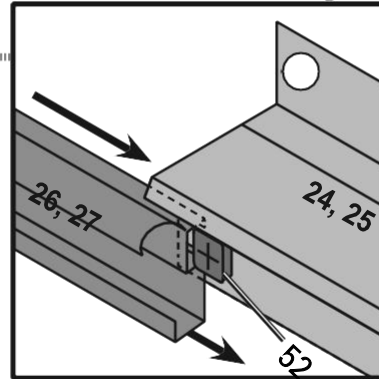

4. Slide the slot on the Left Door Rail (26) over the heads of the remaining three Bolts in the Front-left Ceiling Plate (24) until it presses against the Right Door Rail (27). Tighten the remaining Nuts.

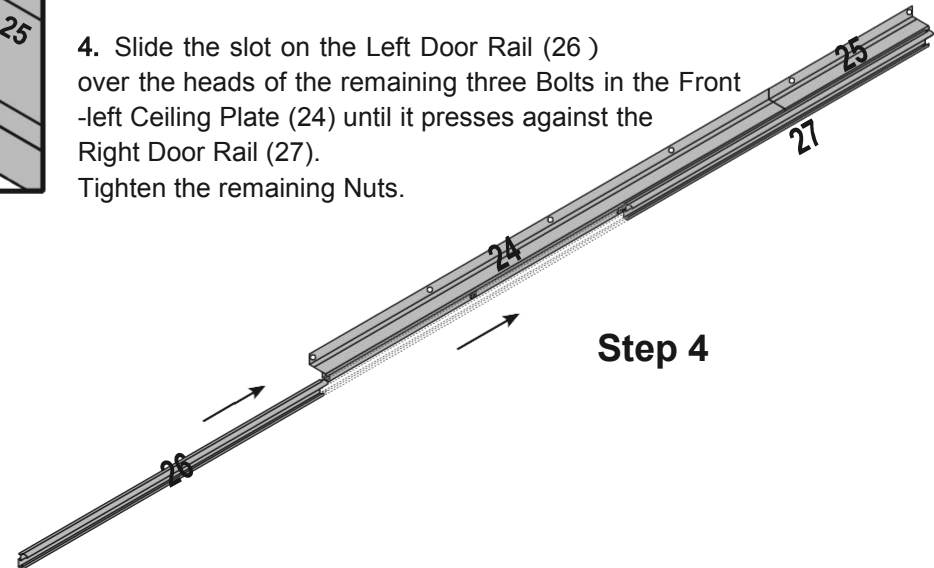

Phase 4b: Ceiling Plate Assembly, Side

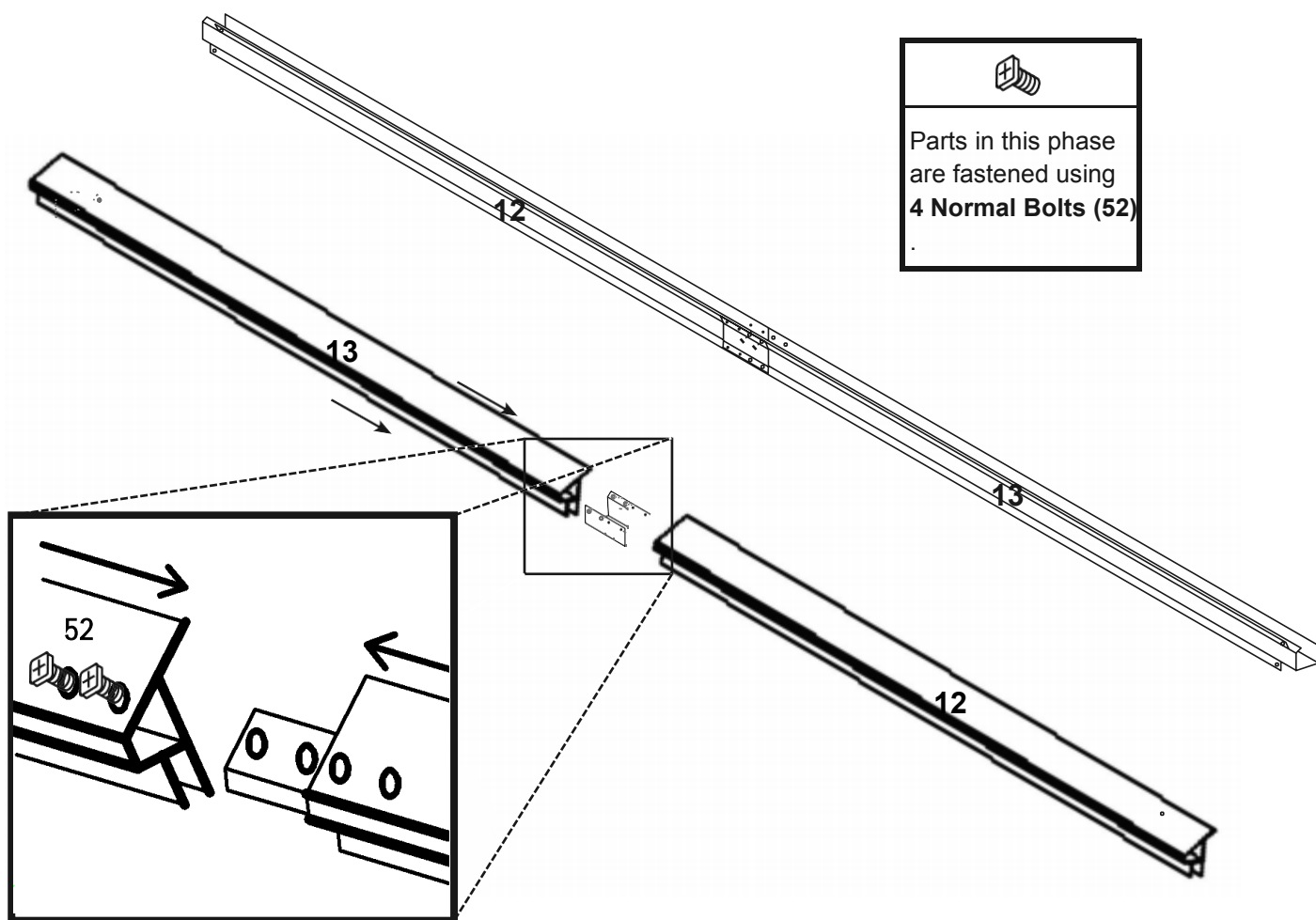

1. Insert a Plain Side Ceiling Plate (13) in the brackets on the end of a Side Ceiling Plate with Brackets (12).
2. Secure in place with two Normal Bolts (52), as shown in the inset above.

3. Repeat the two previous steps for the remaining Plain Side Ceiling Plate (13) and Side Ceiling Plate with Brackets (12).

Phase 5: Ceiling Plate Installation

Grey parts are in place before this phase.

 Means that the nearby Bolt will be removed and then re-attached at the same location.

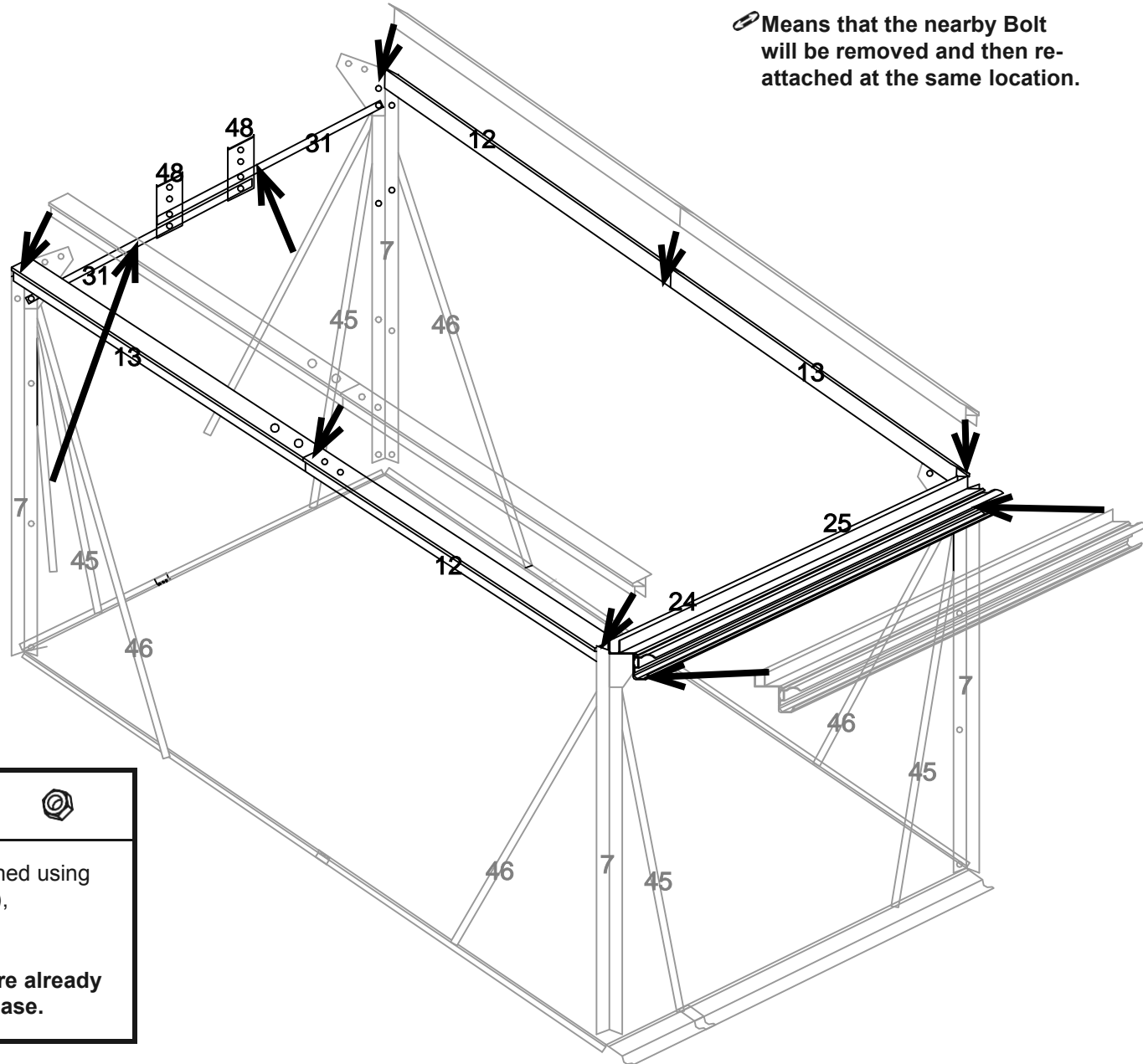

Parts in this phase are fastened using
2 Normal Bolts (52),
4 Brace Bolts (53),
and 6 Nuts (54).
Additional Bolts and Nuts are already
in place before this phase.

Ceiling Plate Installation Instructions

1. Insert one Normal Bolt (52) through the Corner Bracket (49) and the upper hole in the Corner Post (7) at both front corners of the greenhouse, from the inside out, as shown above. This is for the later attachment of the Front Ceiling Plate (24-27).

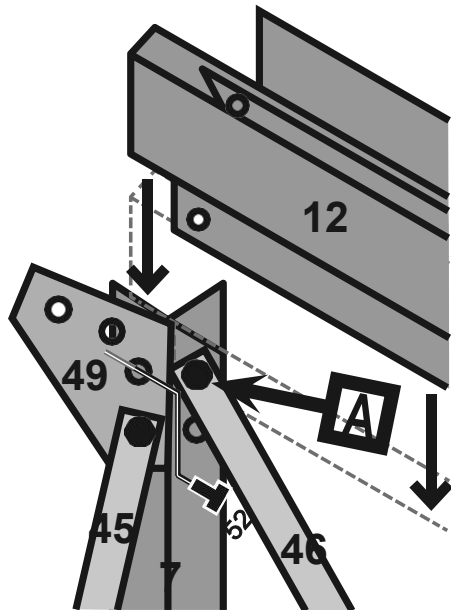

2. To attach one end of a Side Ceiling Plate (12, 13):
 - a. Remove the Nut (54) where the Side Diagonal Strut (46) connects to the Corner Post (7) in one corner, marked A in the illustration above.
 - b. Temporarily disconnect that Side Diagonal Strut (46) from the Brace Bolt (53), but leave the Bolt in place
 - c. Orient the gutter opening up as shown above.
 - d. Place the Side Ceiling Plate (12, 13) then the Side Diagonal Strut (46) on the end of the Bolt, and secure with a Nut (54).
3. Secure the other end of that Side Ceiling Plate (12, 13) similarly.

4. Attach the Front Ceiling Plate (24, 25) to the two Normal Bolts (52) put in place in step 1 on the outside of the greenhouse, note orientation at right.

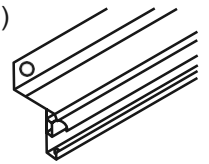

5. Attach the remaining Side Ceiling Plate (12, 13) along the other side according to steps 2 & 3, with the gutter opening up.

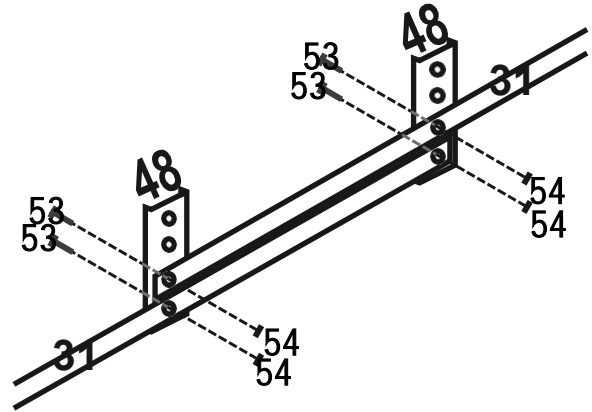

6. Bolt two Post Connectors (48) to a Rear Brace (31) using Brace Bolts (53) through their bottom holes, from the outside in. Place Post Connectors on the outside of the greenhouse with the flat side against the Brace, as shown above. Only finger tighten for now.
7. Swing the Rear Braces (31) together and bolt the second Brace to the *second from bottom holes* on the Post Connectors (48), using Brace Bolts (53) from the outside in. Only finger tighten for now.

Note: The Rear Braces will be under tension.

8. **If you cannot attach the second Post Connector (48), or if they are not parallel:** Make sure that the arrows on both of the Rear Braces (31) are pointing towards the Corner Posts (7).

Post Installation Instructions

Note: All Posts (14) in this phase require extra Bolts to be inserted into their slot before assembly. The small numbers under the main part number on the facing page are the type and number of hardware. See the examples below:

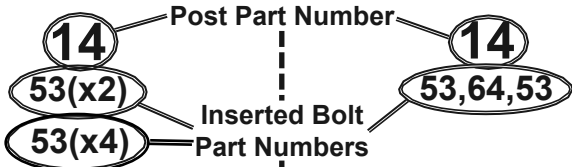
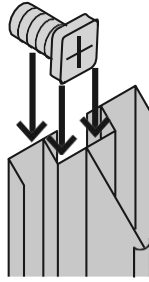

Meaning: Insert two/four Brace Bolts (53) into the Rear Right Post (14) before attaching it.

Meaning: Insert a Brace Bolt (53), then a Double Brace Bolt (64), then another Brace Bolt (53) into this Side Post (14) before attaching it.

1. Loosen a Bolt on one of the Side Floor Plates (3, 4) in an attachment location as shown. Slide the slot in a Side Post (14) over the head of that Bolt.
2. Insert the required Bolts (see note above and illustration on facing page) into the slot in the Side Post.
3. Attach the top of the Side Post (14) to the Ceiling Plate (12, 13), using a Normal Bolt (52) in the slot or using the Bolt already in place for the center Post.
4. Repeat above steps for all fourteen Side Posts (14) on the left and right sides of the greenhouse.
5. Slide a white Bushing (65) over all four inserted Double Brace Bolts (64). Place the center hole of each Side Diagonal Strut (46) over the end of each Double Brace Bolt and secure with a Nut (54).
6. Loosen a Bolt on the Rear Floor Plate (5, 6) in a location that a Side Post (14) attaches, and slide a Side Post over the head of that Bolt. Insert four Brace Bolts (53) into the slot of that Post. (The Side Post (14) in this paragraph is the middle two behind the Green house)

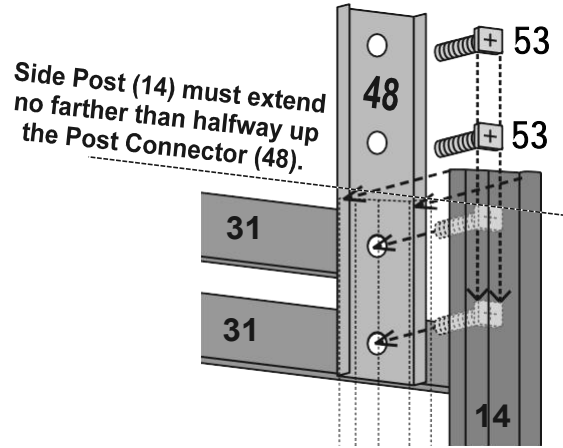

7. Remove the two Brace Bolts (53) connecting the Post Connector (48) near that Side Post. Slide the heads of those Bolts into the Side Post and insert them through the Post Connector. Align the top of the Post with the **center** of the Connector as shown above, and press it in place. Reattach the Rear Braces (31) to the Brace Bolts (53) and secure them.
8. Repeat steps 6 & 7 for another SidePost (14) and Post Connector (48).
9. Loosen the Bolts (53) where the Rear Diagonal Struts (45) connect to the Rear Floor Plate (5, 6). Slide the slot in the Side Post (14) over the head of the **left** Bolt and the Side Post (14) over the **right** Bolt.
10. The slanted ends of the posts must be on top and slant towards the center of the green house. Retighten the Bolts.
11. Slide two Brace Bolts (53) into the slot of each Side Post (14).
12. Slide one more Brace Bolt (53) into the top of each Rear Post. Attach the Rear Posts to the Rear Braces (31) using those Bolts.
13. The frame should now rest square. Measure diagonally from corner to corner at the top. If the measurements are not equal, adjust the frame as needed until square. Some Nuts (54) may need to be loosened to adjust the frame. Tighten all Nuts after adjustment.

Phase 6: Post Installation

Grey parts are in place before this phase.

Means that the nearby Bolt will be removed and then re-attached at the same location.

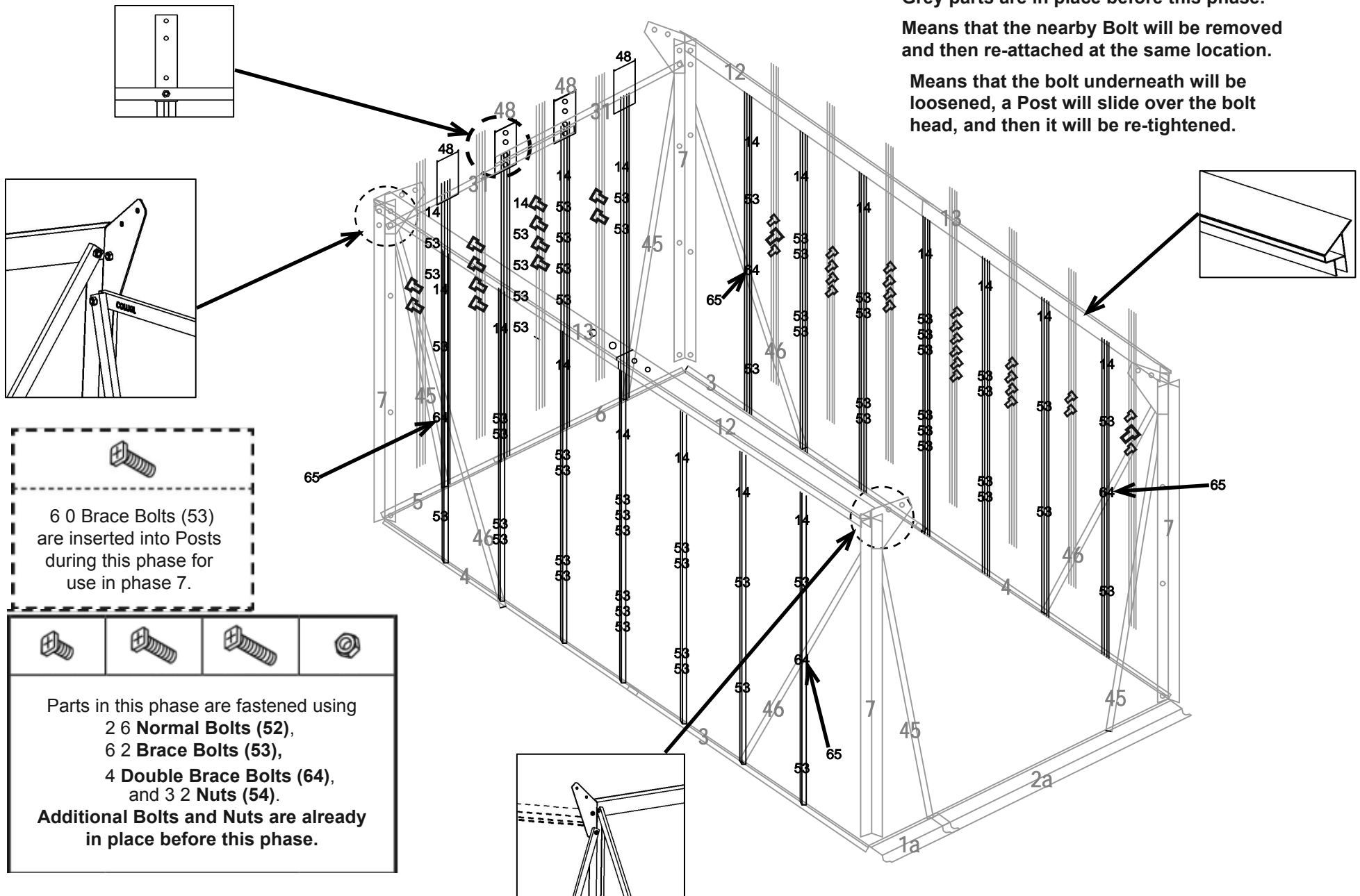

Means that the bolt underneath will be loosened, a Post will slide over the bolt head, and then it will be re-tightened.

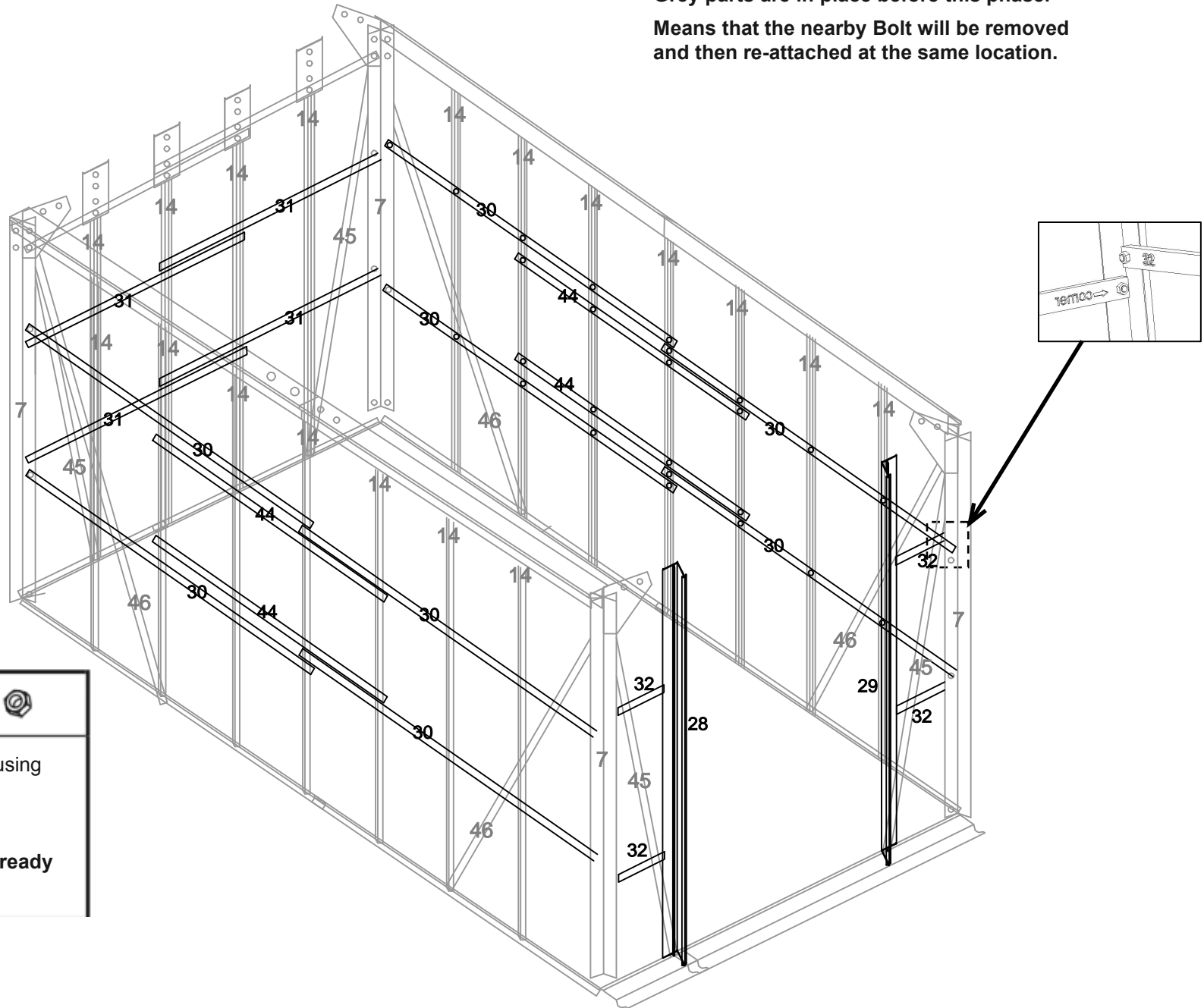

Phase 7: Brace Installation

Grey parts are in place before this phase.
Means that the nearby Bolt will be removed
and then re-attached at the same location.



		
<p>Parts in this phase are fastened using 2 Normal Bolts (52), 20 Brace Bolts (53), and 8 2 Nuts (54). Additional Bolts and Nuts are already in place before this phase.</p>		

Brace Installation Instructions

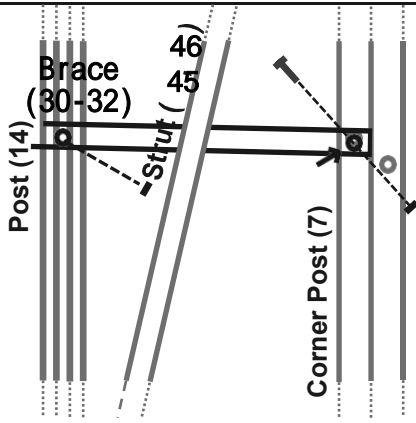

Note: All Braces are installed inside the Posts, but outside the Struts. See diagram above, shown from inside the greenhouse facing out.

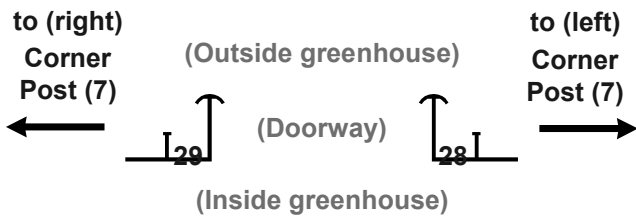

1. Using a Normal Bolt (52) at top and the Brace Bolt (53) already in place at the bottom for each, attach the Left and Right Doorway Posts (28, 29) to the outside of the Front Floor Plates (1a, 2a) and to the inside of the Front Ceiling Plates (24, 25). Install the Posts with the cut-outs at top and oriented as shown in the illustration above.

2. Using Brace Bolts (53), connect the Front Braces (32) between the Corner Posts (7) and the Doorway Posts (28, 29). Install Braces inside Posts but outside Struts, as shown in the diagram at the top of this page.

Note: Install the Braces on the walls so that they are level. If the frame is level and all Braces are level, the Braces should not interfere with one another.

3. Connect the four remaining Rear Braces (31) onto the rear wall as shown on the facing page, with the arrows pointing towards the Corner Posts (7). Secure in place using Brace Bolts (53) at the Corner Post and the inserted Brace Bolts in the remaining holes. Install Braces inside Posts but outside Struts, as shown in the diagram at the top of this page.

4. Connect four Side Braces (30) onto each side wall as shown on the facing page, with the arrows pointing towards the Corner Posts (7). Secure in place using Brace Bolts (53) at the Corner Post and the inserted Brace Bolts in the remaining holes. Install Braces inside Posts but outside Struts, as shown in the diagram at the top of this page.



5. Connect Brace(44) to each side wall by Brace Bolts (53) , with one side wall installed, as shown.

Phase 8: Gable and Crown Installation

Grey parts are in place before this phase.

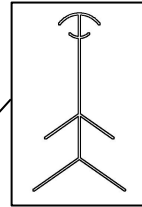
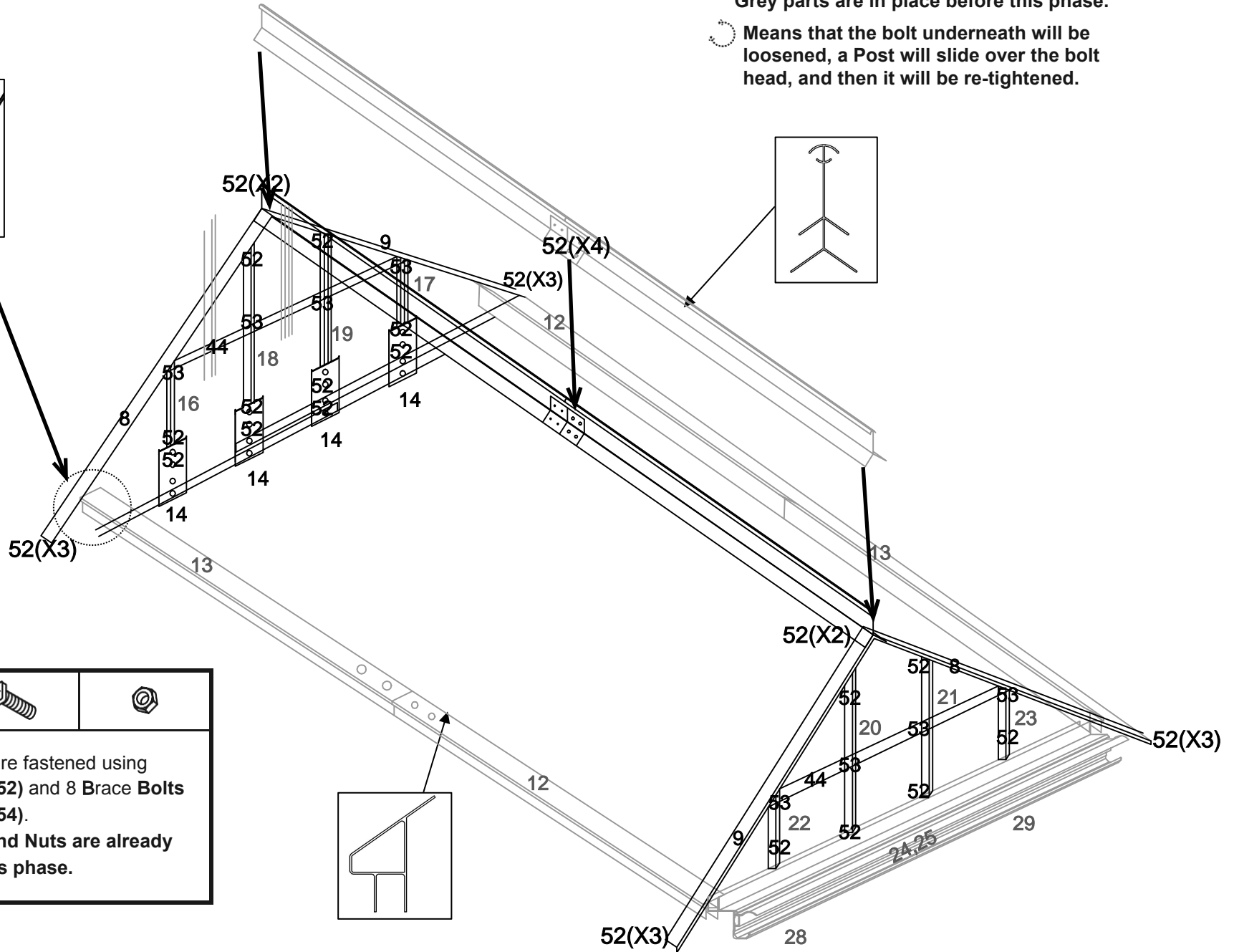
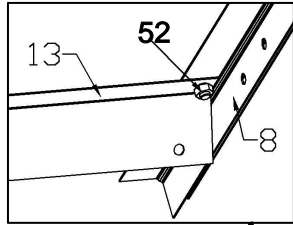
 Means that the bolt underneath will be loosened, a Post will slide over the bolt head, and then it will be re-tightened.



		
<p>Parts in this phase are fastened using 3 6 Normal Bolts (52) and 8 Brace Bolts (53) and 4 4 Nuts (54). Additional Bolts and Nuts are already in place before this phase.</p>		

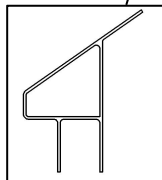

Gable and Crown Installation Instructions

1. First, the Right-handed Crown Beam (8) and Left-handed Crown Beam (9) need to be fixed to Side Ceiling Plate with Brackets (12) or Plain Side Ceiling Plate (13) using Normal Bolt (52). After fixing, fill in Normal Bolts (52) from top to the Right-handed Crown Beam (8) and Left-handed Crown Beam (9). (Note the direction consistent with Fig)

2. Install the Rear Gable Posts and the Front Gable Posts (16-23).

a. Slide three bolts into the slot of the Rear Posts (16, 17), of which, two Normal Bolts (52) are placed at the bottom and one Brace Bolt (53) is placed at the top. Fix the bottom of the Rear Posts (16, 17) to the two holes of the Post Connectors (48) with the two Normal Bolts (52) at the bottom, as shown in the figure. The top Brace Bolt (53) will be used in the next step.

b. Slide four bolts into the slot of the Rear Gable Posts (18, 19), of which, two Normal Bolts (52) are placed at the bottom, one Brace Bolt (53) is placed in the middle, and one Normal Bolt (52) is placed at the top. Use the bottom two Normal Bolts (52) to fix the bottom of the Rear Gable Posts (18, 19) to the two holes of the Post Connectors (48), and use the top Normal Bolt (52) to fix the top of the Rear Gable Posts (18, 19) to the Crown Beams (8,9), as shown in the picture. The Brace Bolt (53) will be used in the next step.

c. Slide a Normal Bolt (52) and a Brace Bolt (53) into the slot of the Front Gable Posts (22, 23), of which, one Normal Bolt (52) is placed at the bottom and one Brace Bolt (53) is placed at the top. Fix the bottom of the Front Gable Posts (22, 23) to the Front Ceiling Plates (24, 25) with the bottom Normal Bolt (52), as shown in the figure. The top Brace Bolt (53) will be used in the next step.

d. Slide three bolts into the slot of the Front Center Gable Posts (20, 21), of which one Brace Bolt (53) is in the middle and two Normal Bolts (52) are at the bottom and top respectively. Fix the bottom and top of the Front Center Gable Posts (20, 21) to the Front Ceiling Plates (24, 25) and the Crown Beams (8, 9) with the bottom and top Normal Bolts (52) respectively, as shown in the figure. The middle Brace Bolt (53) will be used in the next step.

3. Use the Brace Bolts (53) pre-placed on Gable Posts (18,19,20,21) in the previous step to fix the middle two holes of the Brace (44) on Gable Posts(18,19,20,21), and then use the Brace Bolts (53) pre-placed on Gable Posts (16,17,22,23) through the holes on the Crown Beams (8, 9) and the holes at both ends of the Brace (44) to fix the Brace (44) on Crown Beams (8,9).

4. Connect the Rear Crown with Brackets (10) and the Front Crown (11) with Normal Bolts (52), and then use Normal Bolts (52) and Nuts (54) to fix the connected (10, 11) to the top of Crown Beams (8,9).

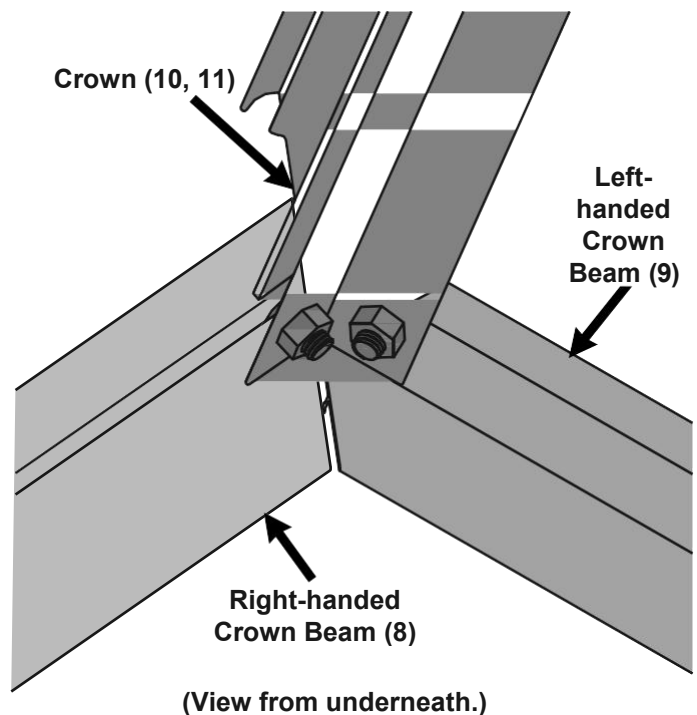

Rafter and Brace Installation Instructions

Note: All Rafters (15) require extra Bolts to be inserted into their slot before assembly. The small numbers under the main part number on the facing page are the type and number of hardware **in the order they are inserted from the TOP of the Rafter.** See the examples below:

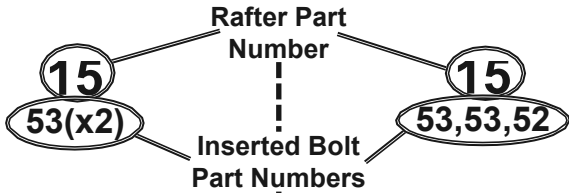
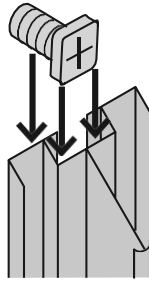

Meaning: Insert two Brace Bolts (53) into the top of this Rafter (15) before attaching it to the frame.

Meaning: Insert two Brace Bolts (53), then a Normal Bolt (52) into the top of this Rafter (15) before attaching it to the frame.

1. Insert the required Bolts (see note above and illustration on facing page) into the slot in one of the Rafters.
2. Attach the Rafter to the Ceiling Plate (12, 13) and the Crown (10, 11), using Normal Bolts (52) in the slot or using the Bolts already in place for the center Rafters.
3. Make sure the Rafter is completely seated over the Normal Bolts (52) on each end before tightening
4. Repeat above steps for all fourteen Rafters.

5. Connect four Side Braces (30) onto the underside of the roof as shown on the facing page, with the arrows pointing towards the Crown Beams (8, 9). Secure in place using Brace Bolts (53) at the Crown Beam and the inserted Brace Bolts in the remaining holes. Finger tighten first and install the Braces so that they are touching, side-by-side as shown.



(View from underneath.)

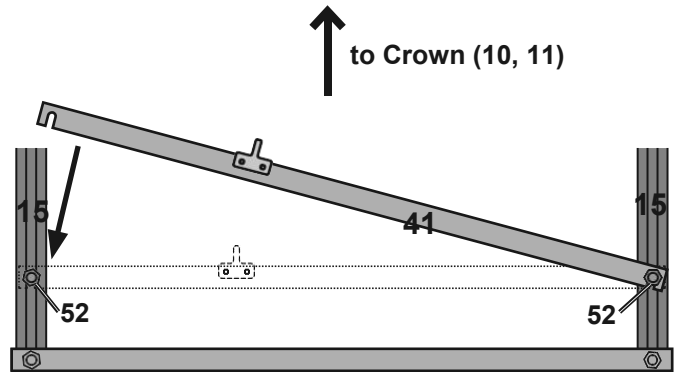

(View from underneath.)

6. Place one of the bolt slots on a Window Support Beam (41) over one of the inserted Normal Bolts (52) and swing it over the inserted Normal Bolt on the other Rafter as shown in the diagram above. Note that the Window Support Beam (41) and flat side of the Window Support Beam are both facing the inside of the greenhouse. Thread Nuts (54) onto the Normal Bolts and finger tighten them for now.

Phase 9: Rafter and Brace Installation

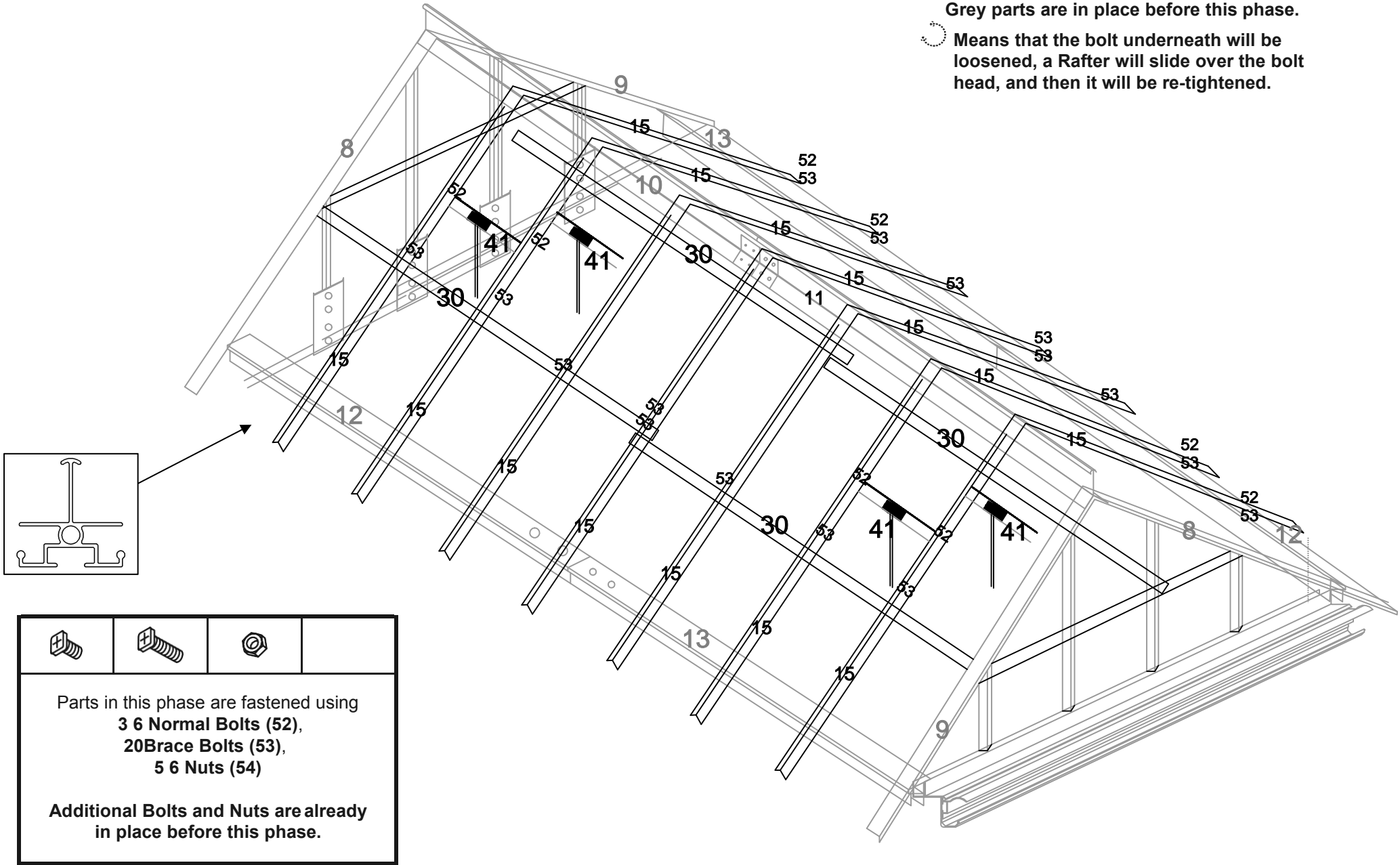

Grey parts are in place before this phase.
 Means that the bolt underneath will be loosened, a Rafter will slide over the bolt head, and then it will be re-tightened.

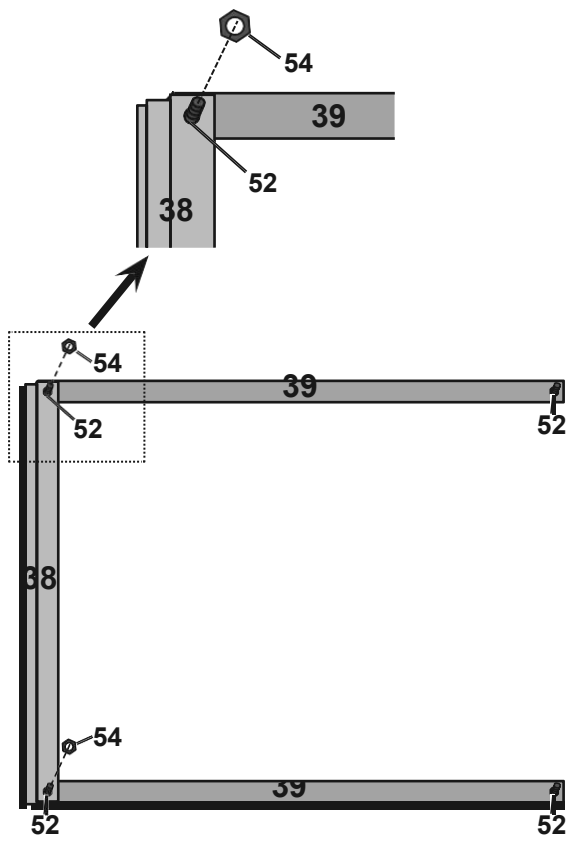

Phase 10: Window Assembly and Installation



(View from underneath window, flat side of pieces.)

		
Parts in this phase are fastened using 16 Normal Bolts (52), 16 Nuts (54).		

1. Attach the Side Window Frames (39) to the Top Window Frame (38), as shown to the left. The threaded shafts of the Bolts should extend out the bottom of the window.
2. Insert Normal Bolts (52) into the holes at other end of the Side Window Frames, so that the threads stick out the bottom of the window.

3. Remove the protective film from both sides of the Window Pane (75). Slide the Window Pane into the three-sided frame.
4. Slide the Bottom Window Frame (40) onto the two Normal Bolts (52) and the Window Pane. Secure it in place with Nuts (54). Press on the heads of the Bolts through the Window Pane to allow the Nuts to thread on properly.

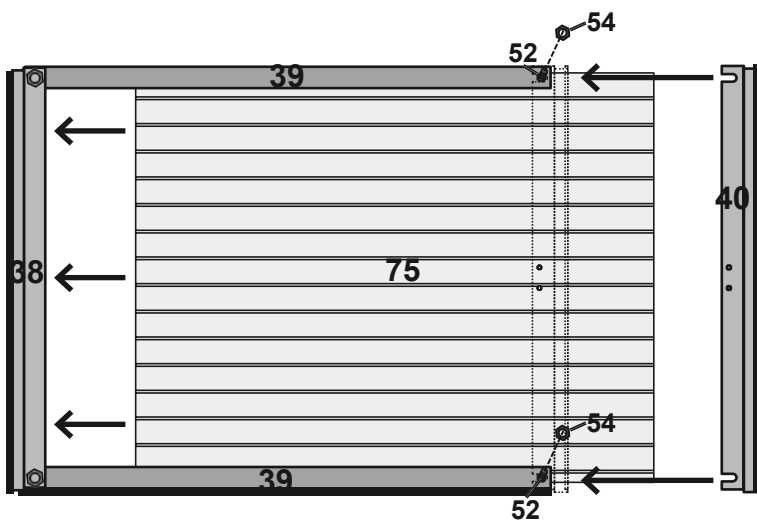

(View from underneath window, flat side of pieces.)

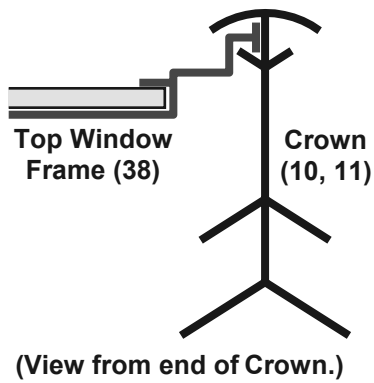
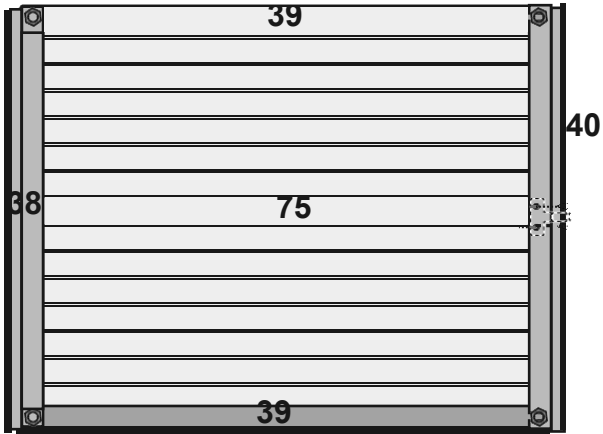

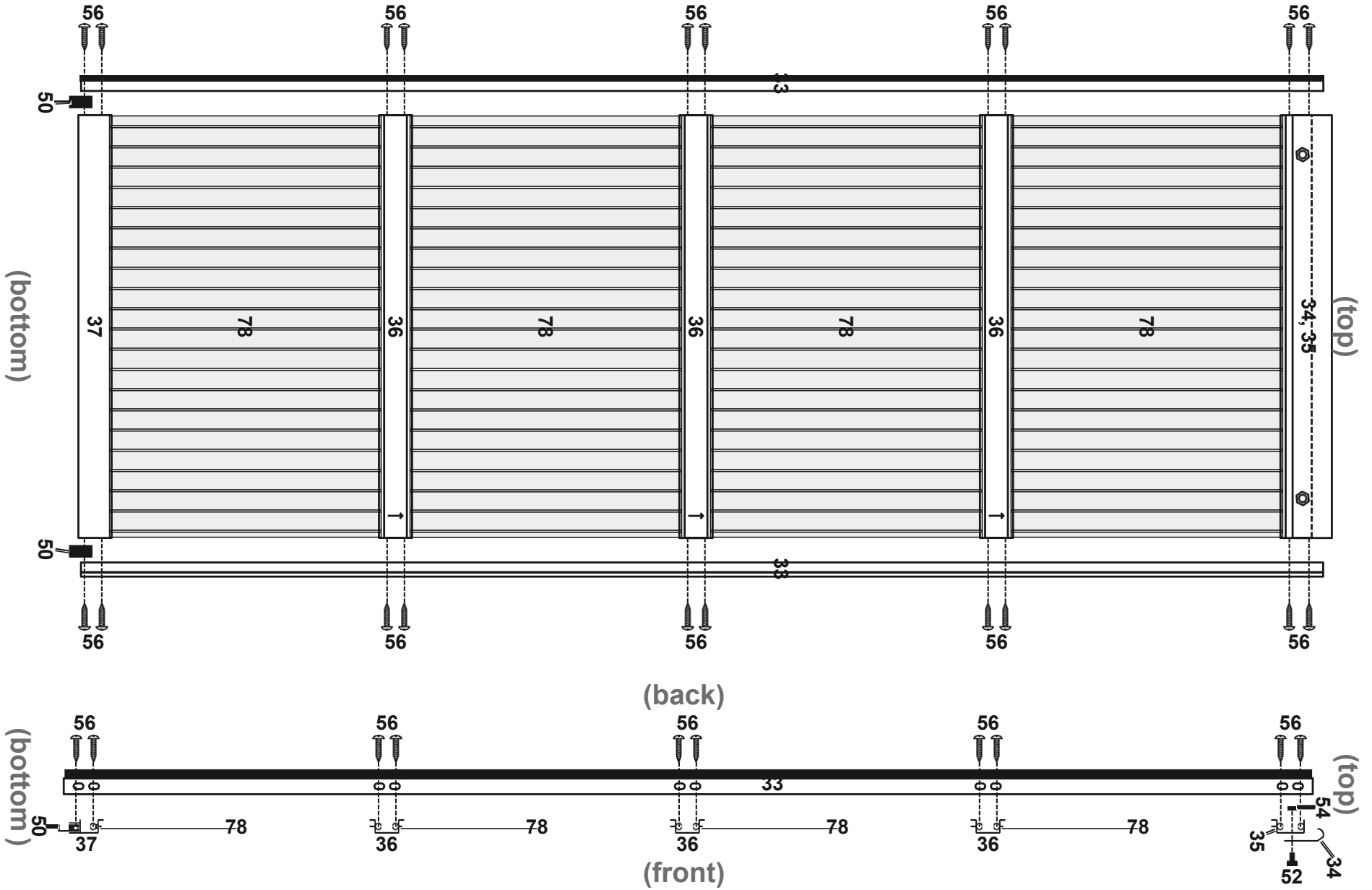

5. Hold the assembled window level with the ground at the outer edge of the Crown (10, 11). Slide the top edge of the Top Window Frame (38) into the slot at the top of the Crown – see illustration to the left. Align the window with the bottom Window frame(40) underneath it. Gradually lower it into place.
6. Loosen the Nuts (54) holding the Window Support Beam in place and slide the Window Support Beam up to touch the window. Secure it in place.
7. Repeat the steps in this phase for all four windows.

Phase 11: Door Assembly and Installation



(Profiles exaggerated for clarity.)

Door Assembly and Installation Instructions

		
<p>Parts in this phase are fastened using 8 Normal Bolts (52), 8 Nuts (54), and 40 Door Screws (56).</p>		

Note: The Door Screws (56) thread directly into the round portions in the center of the door frames. Leave all Screws slightly loose until the door is mounted on the rail.

- Place the Side Door Frame (33) with the rubber flap down. Attach three Center Door Frames (36) to the Side Door Frame (33). Assemble them with the rounded portion facing the front (away from the flap), as shown to the right.

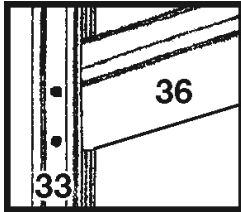

- Using two Normal Bolts (52) and two Nuts (54), attach the Door Slider (34) to the Top Door Frame (35) oriented as shown to the right.

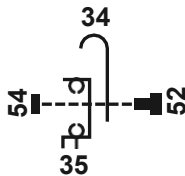

- Attach the Top Door Frame (35) to the Side Door Frames (33) with the Door Slider (34) at top and the rounded portion facing the front.

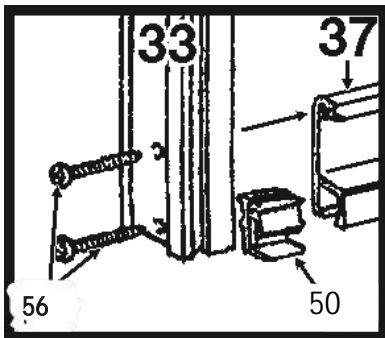

(view from behind)

- Insert a Door Bottom Slider (50) into each end of the Bottom Door Frame (37). Make sure that the Sliders are assembled the correct way, with the gap facing the back of the door – see diagram. Attach the Bottom Door Frame to the Side Door Frames (33) using two Screws (56) on each side – the one on the top into the Bottom Door Frame and the bottom one into the Door Bottom Slider.
- Remove the protective film from both sides of four Door Panels (78). Slide the Door Panels into the door between the Door Frame (35-37) pieces.
- Attach the other Side Door Frame (33) to the Center Door Frames (36) in the same way.

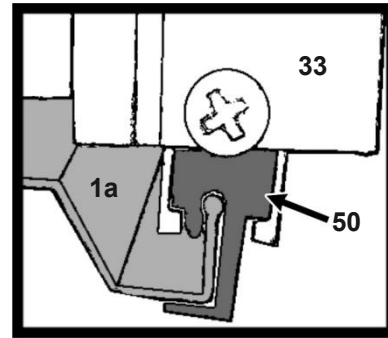

(side view)

- Raise the assembled Door up and insert the first roller of its Door Slider (34) onto the Door Rail (26, 27). Carefully align the first Bottom Door Slider (50) over the edge of the Front Floor Plate (1a, 2a) – see illustration above. Carefully slide the door over and align the other top Roller and bottom Slider as you did the first ones.
- Assemble and install the second door by following the previous steps.
- Once both doors are installed, tighten all Door Screws (56).
- Install a Normal Bolt (52) and Nut (54) into the hole on the end of each Door Rail (26, 27), and in the hole on the end of each Front Floor Plate (1a, 2a) to prevent the doors from sliding off the rails. Attach the Left and Right Rail End Caps (60, 61) onto the ends of the Door Rails.

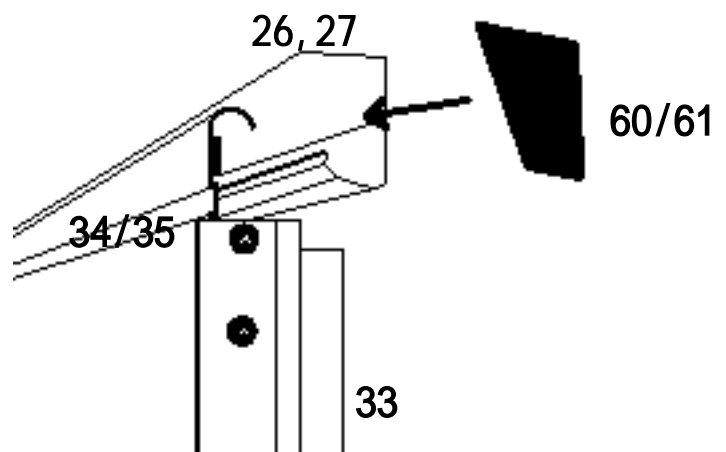

(Move the door top side view)

Phase 12: Panel Installation

For technical questions, contact us.

X = Panel fixtures(51) Location
O = Panel Connector (42) Location

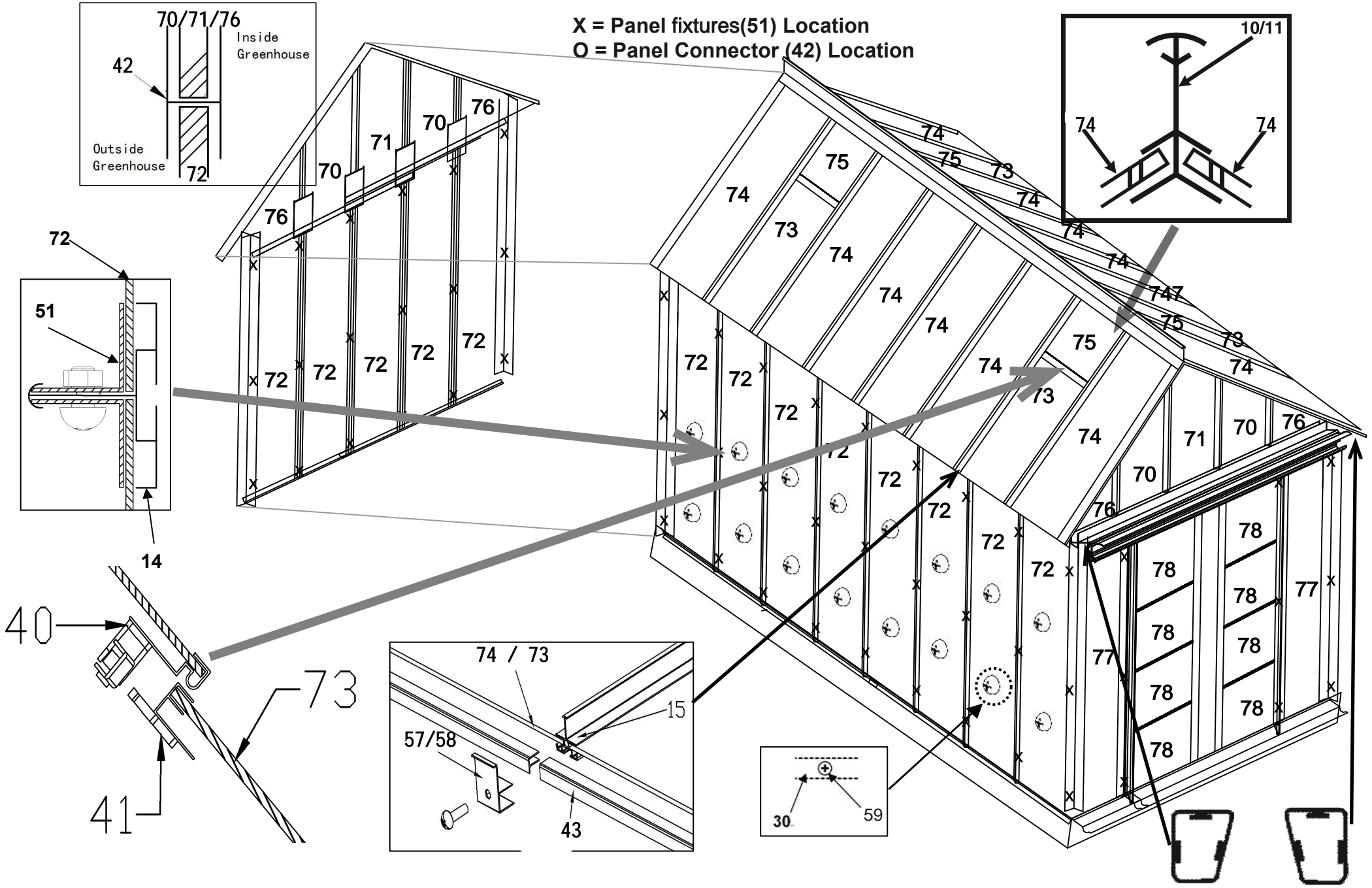

Transparent Panel Installation Instructions

1. Panel fixtures (51) are used to secure the Transparent Panels in place on the Greenhouse. Their locations are marked with X on the facing page.
2. The Roof Panels (74) and the Roof Window Panel (73) will need to be placed as shown in the insets on the facing page. The top edges of these panels need to be placed up under the edge of the Crown (10, 11) or the Window Support Beam (41).
3. The Panel Connectors (42) are used to connect the Rear Top and Center Panels (70 , 71) to the top of the Wall Panels (72) in the rear of the Greenhouse. Refer to the locations marked with O and the inset on the facing page.
4. One at a time, place each Transparent Panel (70– 7 8) in its proper location on the Ceiling and Frame of the Greenhouse. Then, secure the Transparent Panel in place, using the quantity and location of Panel Clips as shown on facing page.
5. To attach Panel Clips, see illustration and instructions below. Use the included Phillips screwdriver(55) to facilitate Panel Clip installation.
 - a. Place the two loose ends of the Clip into the groove in the frame.
 - b. Swing the center portion of the Clip up against the Panel.
 - c. Two edges of the Clip swing under the edge of the panel and the center edge holds the panel in place. Secure with normal bolt (52) and nut (54)
6. Break the self-tapping screw (59) into the middle position to secure the panel again

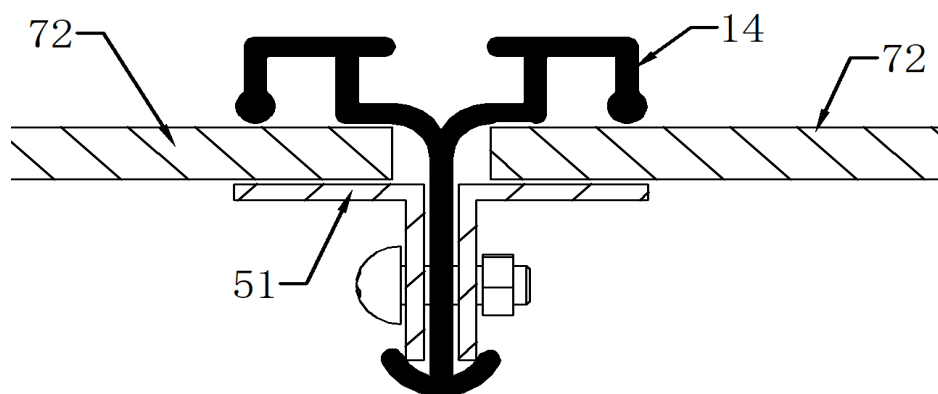

Be careful, Panel Clip ends may be sharp and may spring back!

Use and Maintenance

1. **BEFORE EACH USE**, inspect the general condition of the Greenhouse. Check for loose screws, misalignment or binding of moving parts, cracked or broken parts, and any other condition that may affect the safe operation of the Greenhouse. If a problem occurs with the Greenhouse, have it corrected before further use.
Do not use damaged equipment.
2. **TO CLEAN**: Wipe with a damp cloth, using a mild detergent.
Do not use cleaners that are combustible, corrosive, or not compatible with aluminum.
3. **WHEN STORING**: Keep the Greenhouse in a box and in a clean, dry location.

Limited 90 Day Warranty

We sellers make every effort to assure that its products meet high quality and durability standards, and warrants to the original purchaser that this product is free from defects in materials and workmanship for the period of 90 days from the date of purchase. This warranty does not apply to damage due directly or indirectly, to misuse, abuse, negligence or accidents, repairs or alterations outside our facilities, criminal activity, improper installation, normal wear and tear, or to lack of maintenance. We shall in no event be liable for death, injuries to persons or property, or for incidental, contingent, special or consequential damages arising from the use of our product. Some states do not allow the exclusion or limitation of incidental or consequential damages, so the above limitation of exclusion may not apply to you. THIS WARRANTY IS EXPRESSLY IN LIEU OF ALL OTHER WARRANTIES, EXPRESS OR IMPLIED, INCLUDING THE WARRANTIES OF MERCHANTABILITY AND FITNESS.

To take advantage of this warranty, the product or part must be returned to us with transportation charges prepaid. Proof of purchase date and an explanation of the complaint must accompany the merchandise. If our inspection verifies the defect, we will either repair or replace the product at our election or we may elect to refund the purchase price if we cannot readily and quickly provide you with a replacement. We will return repaired products at our expense, but if we determine there is no defect, or that the defect resulted from causes not within the scope of our warranty, then you must bear the cost of returning the product.

This warranty gives you specific legal rights and you may also have other rights which vary from state to state.