

# **XWG-095**

## **INSTRUCTION MANUAL**

### **11 FT x 13 FT Wood Framed Gazebo**

The gazebo comes with 4 boxes. Sometimes they may be delivered on different day, please wait 2-3 more days or contact us for help.

**Note: The gazebo needs to be installed in cooperation with five people. The following tools are not included and needed for assembly:**



Pistol Drill



Tape Measure

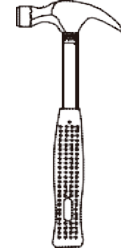

Hammer



Screw Driver

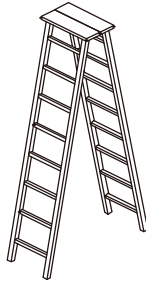

2 m Adjustable Ladder

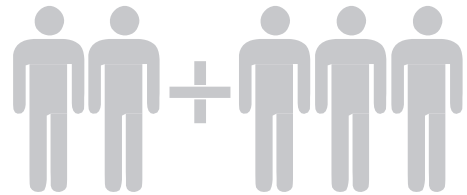

5 people

## Warning







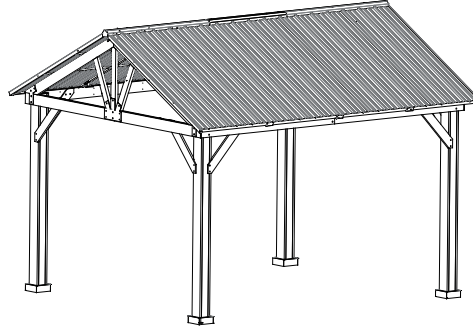



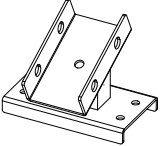

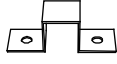

1. A 5 person assembly is required for this gazebo.
2. Please take appropriate actions as heavy rain, wind and snow can damage the gazebo. If necessary please dis-assemble and store for later use.
3. In snowy conditions, please do not allow the thickness of the snow to be more than 1.97 inch on the roof, this should be cleared as soon as possible for your safety. When the wind speed reaches 61.2km/h, please take measures to avoid the wind.
4. Care the wooden structure of the gazebo like painting with anticorrosive paint every two months or dry the wooden parts and then paint when it is in rainy season, which can let the gazebo service longer.

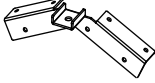
## Attention:

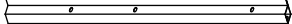
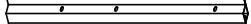
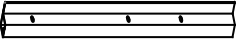
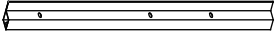
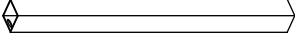
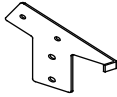
1. Please fix all the screws first, do not lock off, after assembling is fully completed, lock all at once finally.
2. Please check the manual carefully and make sure you have received all the parts.
3. If there is any missing, please let us know the letter of the parts you need.
4. If there is any damage, please send clear photos to us, we will check and offer you best solution soon.

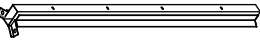

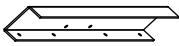
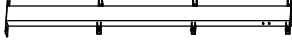
### Parts List (Box A)



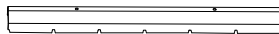

<b>I</b>  Middle Beam Lower Connector	<b>T</b>  Catch	<b>O</b>  Small Beam Presser	<b>Q</b>  Press Panel	<b>M2</b>  Big Roof Side Tube 2
6 PCS	2 PCS	8 PCS	6 PCS	2 PCS
<b>U</b>  Roof Side Cover	<b>C4</b>  Triangular Connector	<b>J1</b>  Support Tube 1	<b>L1</b>  Big Roof Lower Tube 1	<b>L2</b>  Big Roof Lower Tube 2
4 PCS	2 PCS	3 PCS	2 PCS	2 PCS
<b>L3</b>  Big Roof Lower Tube 3	<b>L4</b>  Big Roof Lower Tube 4	<b>N</b>  Big Roof Small Beam	<b>C1</b>  Triangular Connector 1	<b>C2</b>  Triangular Connector 2
2 PCS	2 PCS	16 PCS	2 PCS	2 PCS
<b>F1</b>  Big Roof Beam 1	<b>F2</b>  Big Roof Beam 2	<b>G1</b>  Roof Beam Connector 1	<b>H</b>  Big Roof Middle Beam	<b>M1</b>  Big Roof Side Tube 1
1 PC	1 PC	1 PC	6 PCS	2 PCS

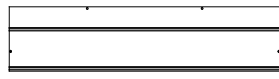
<b>R1</b>	<b>R2</b>			
				
Big Roof Cover 1	Big Roof Cover 2			
2 PCS	1 PC			

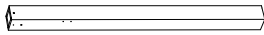

**Parts List (Box B)**

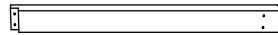
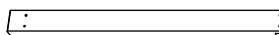
<b>P1</b>	<b>P2</b>			
				
Big Roof Cover	Small Roof Cover			
10 PCS	4 PCS			

**Parts List (Box C)**

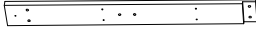
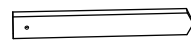
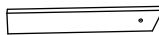

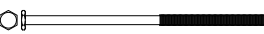

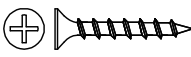
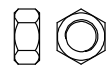
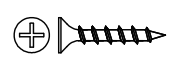

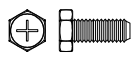
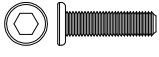
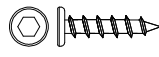
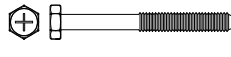
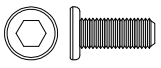





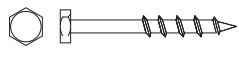



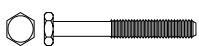

<b>08</b>	<b>13</b>	<b>02</b>	<b>01</b>	<b>10</b>
				
Post	Triangular Support Beam	Outer Long Right Beam (Long)	Outer Long Left Beam (Long)	Arc Support 1
2 PCS	2 PCS	2 PCS	2 PCS	2 PCS

<b>07</b>	<b>14</b>	<b>15</b>		
				
Inner Short Beam (Long)	Triangular Middle Support Beam	Triangular Frame Slanting Beam		
4 PCS	2 PCS	4 PCS		

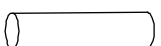
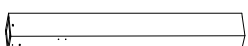
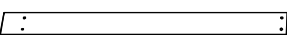
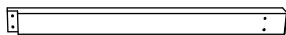
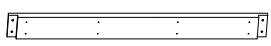
<b>AA</b>	<b>BB</b>	<b>CC</b>	<b>DD</b>	<b>EE</b>
				
Bolt M10*205	Flat Washer M6	Screw M5*40	Nut M6	Screw M5*30
8 PCS	140 PCS	72 PCS	12 PCS	72 PCS

<b>FF</b>	<b>HH</b>	<b>II</b>	<b>JJ</b>	<b>KK</b>
				
Bolt M6*15	Bolt M8*35	Bolt M8*35	Bolt M6*55	Bolt M8*25
108 PCS	16 PCS	16 PCS	12 PCS	24 PCS

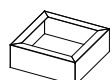

<b>LL</b>	 Non-slip Nuts M10	<b>MM</b>	 Flat Washer M8	<b>NN</b>	 Flat Washer M10	<b>OO</b>	 Screw M10*80	<b>PP</b>	 Stake Ø8*180
8 PCS		84 PCS		24 PCS		8 PCS		8 PCS	
<b>QQ</b>	 Bolt M6*35	<b>RR</b>	 M3 Drill	<b>UU</b>	 Non-slip nuts M8	<b>WW</b>	 Bolt M8*50	<b>Z1</b>	 Wrench M6
8 PCS		2 PCS		14 PCS		14 PCS		2 PCS	
<b>Z2</b>	 Allen Key M8	<b>Z3</b>	 Wrench M8	<b>Z4</b>	 Wrench M10	<b>P</b>	 Hook	<b>S</b>	 Steel Pin
1 PCS		2 PCS		2 PCS		1 PC		12 PCS	
<b>Parts List (Box D)</b>									
<b>08</b>	 Post	<b>03</b>	 Outer Long Left Beam (Short)	<b>04</b>	 Outer Long Right Beam (Short)	<b>05</b>	 Inner Middle Beam	<b>06</b>	 Inner Short Beam (Short)
2 PCS		2 PCS		2 PCS		4 PCS		4 PCS	
<b>10</b>	 Arc Support 1	<b>11</b>	 Arc Support 2	<b>13</b>	 Triangular Support Beam	<b>B</b>	 Base Cover	<b>C</b>	 Base
2 PCS		4 PCS		2 PCS		4 PCS		4 PCS	

<1>



08 4x

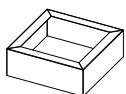

B 4x

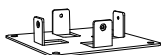

C 4x

STEP1

STEP2

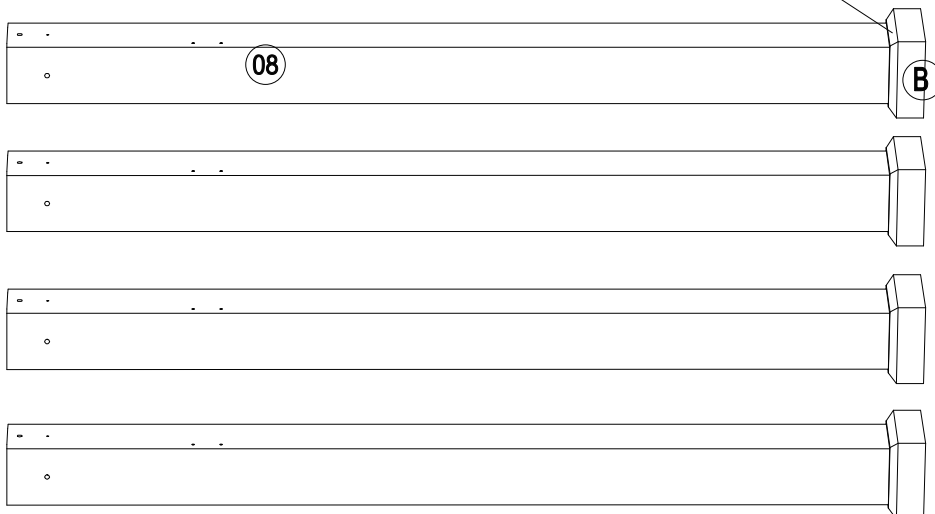
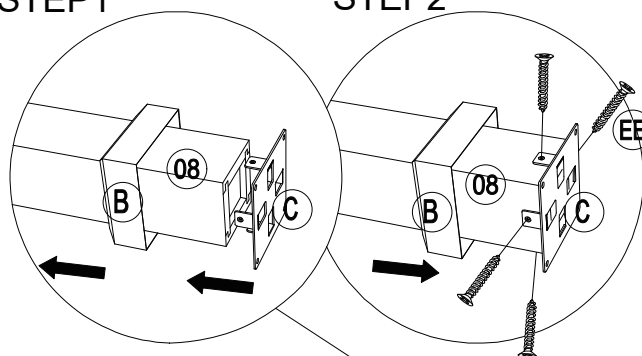

1



EE 16x

M5x30

<2>



05 4x

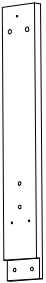

06 4x



07 4x

2

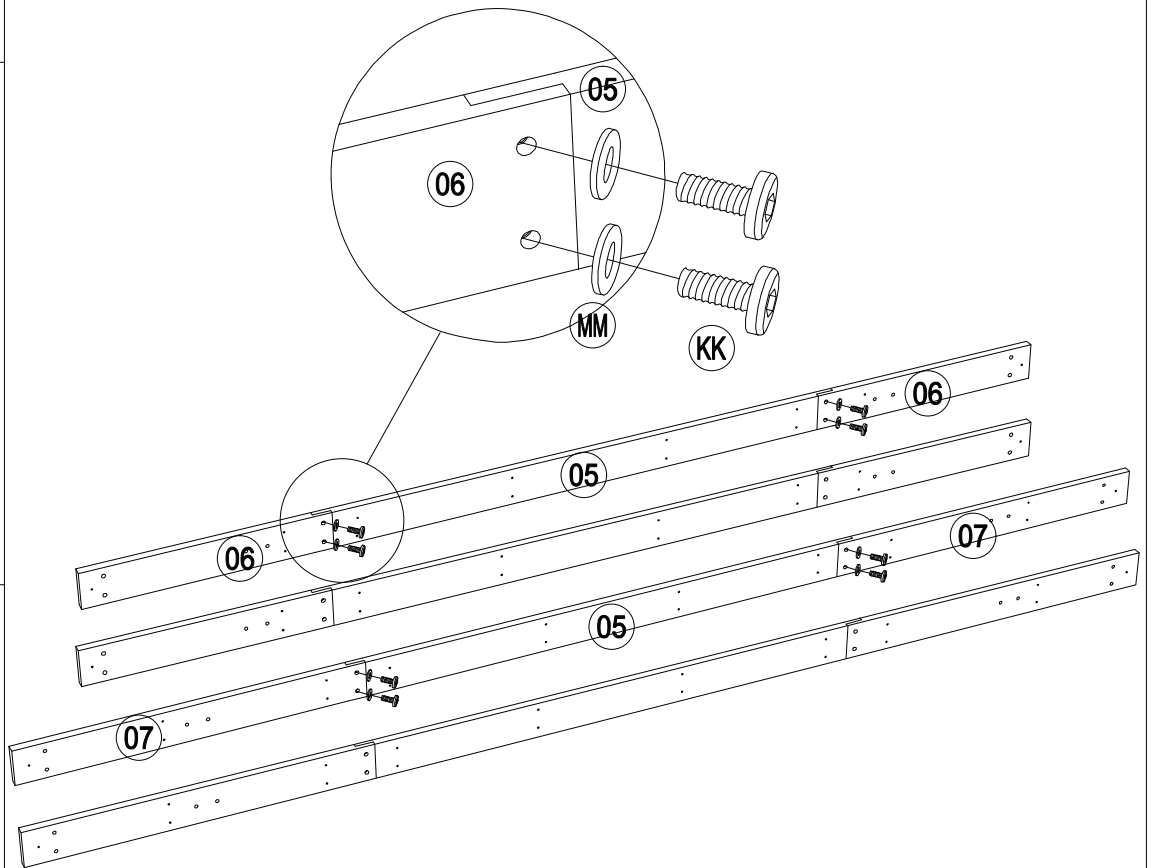

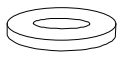
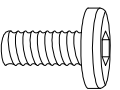
 M8 MM 16x	 M8x25 KK 16x
---	--

<3>



03 2x



04 2x



T 2x

3

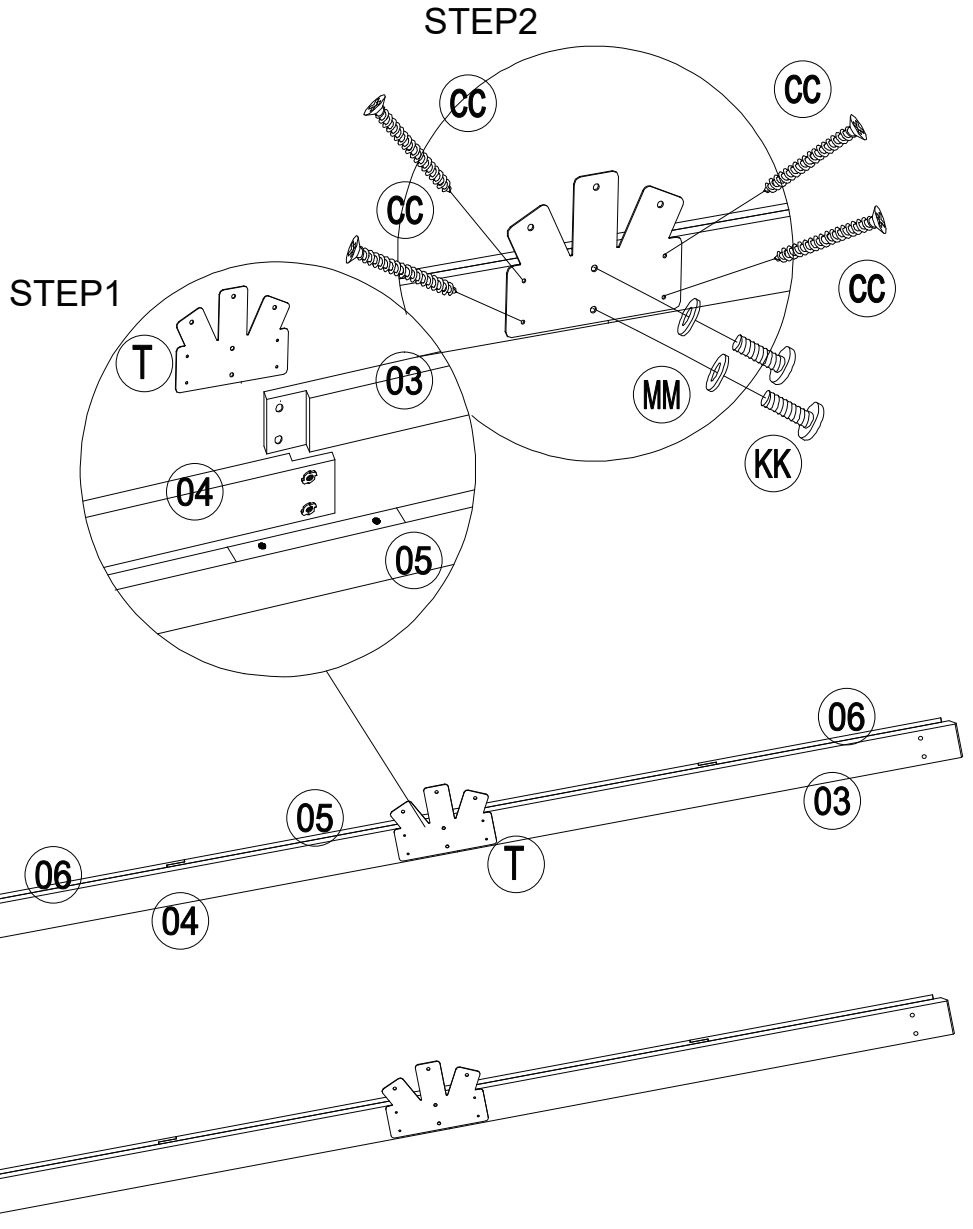

Attention:

Please make sure that the two sides are corresponded when assemble.



M8

MM 4x

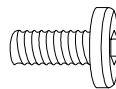

M8x25

KK 4x



M5x40

CC 8x

<4>



01 2x



02 2x

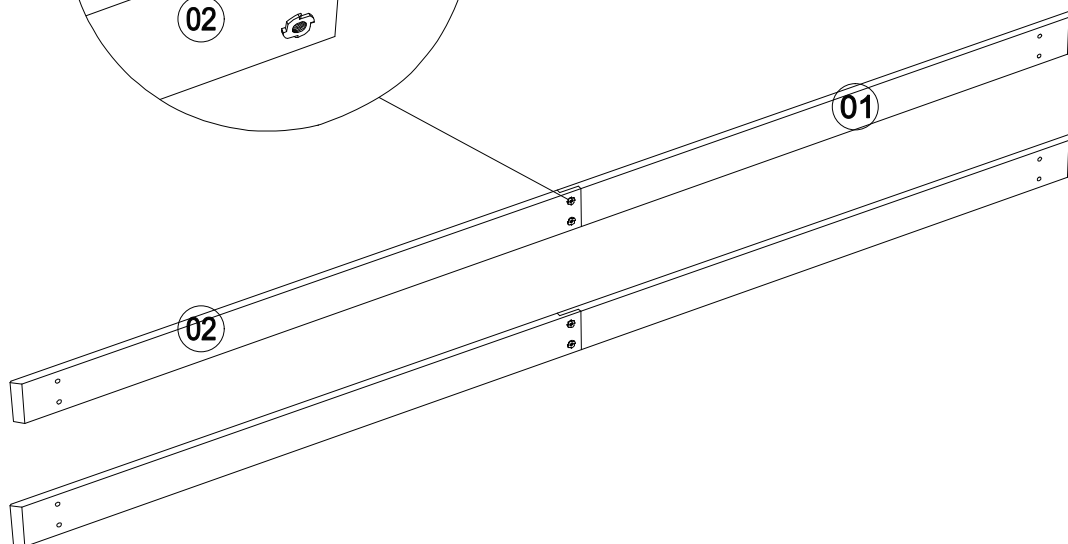
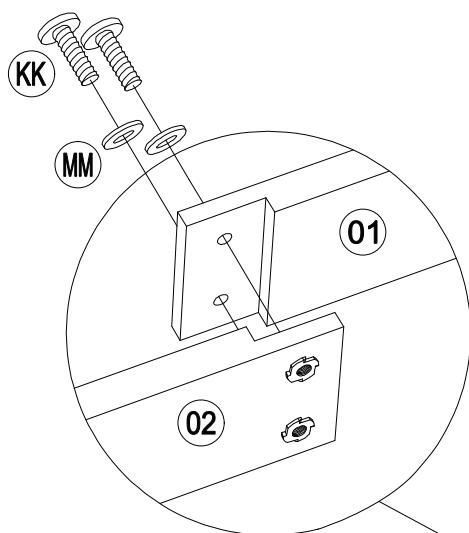

4



M8

MM 4x

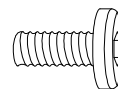

M8x25

KK 4x

<5>

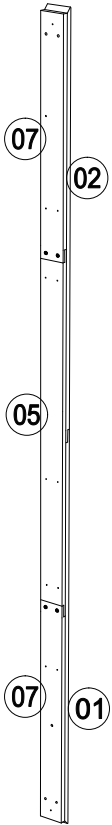

2x

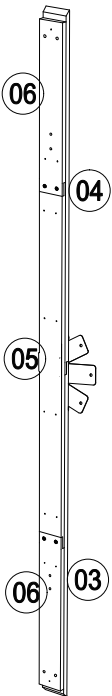

2x

5

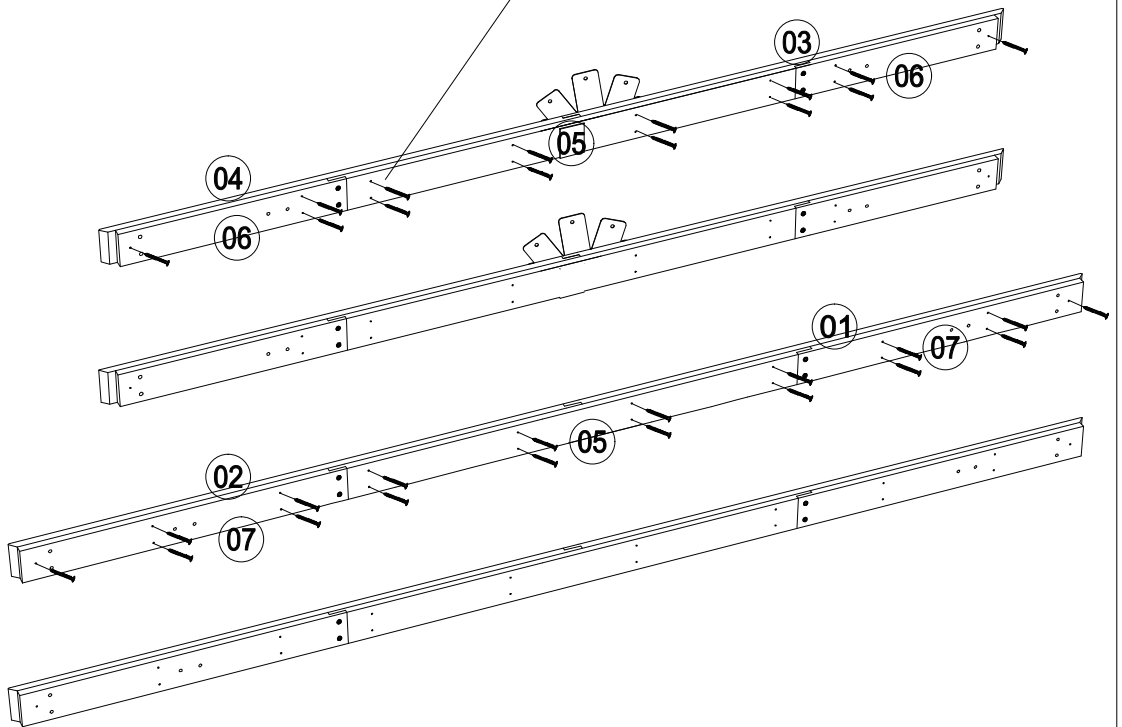
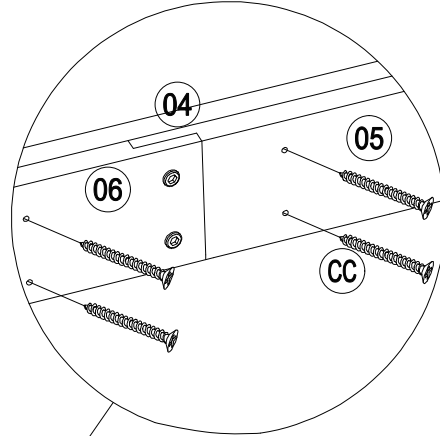

Attention:  
Pay attention to the side of Beam (01) and Beam (02) when join them with Beam (05) and Beam (07).



CC 64x

M5x40

<6>

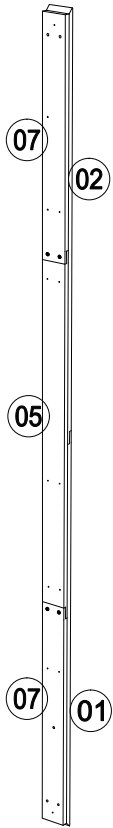

2x

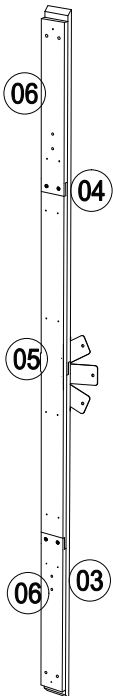

2x

6

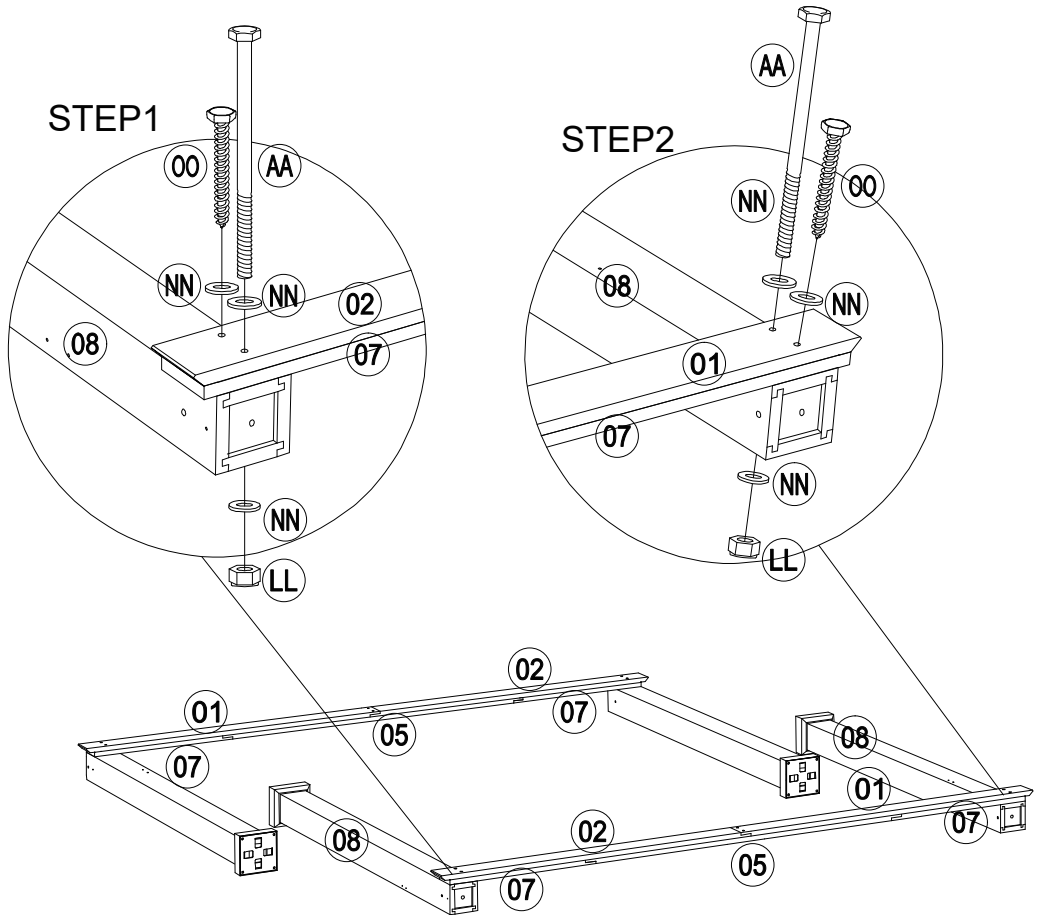

Attention:

1. Pay attention to each side of Post (08).
2. Flat installation please.

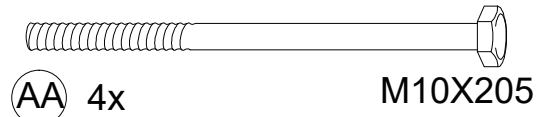
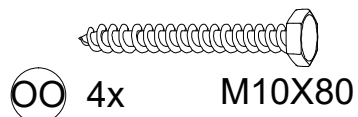
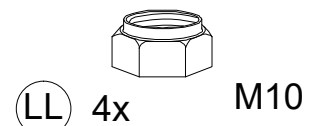
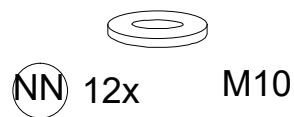

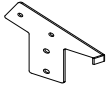

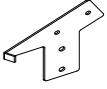

C1 2x

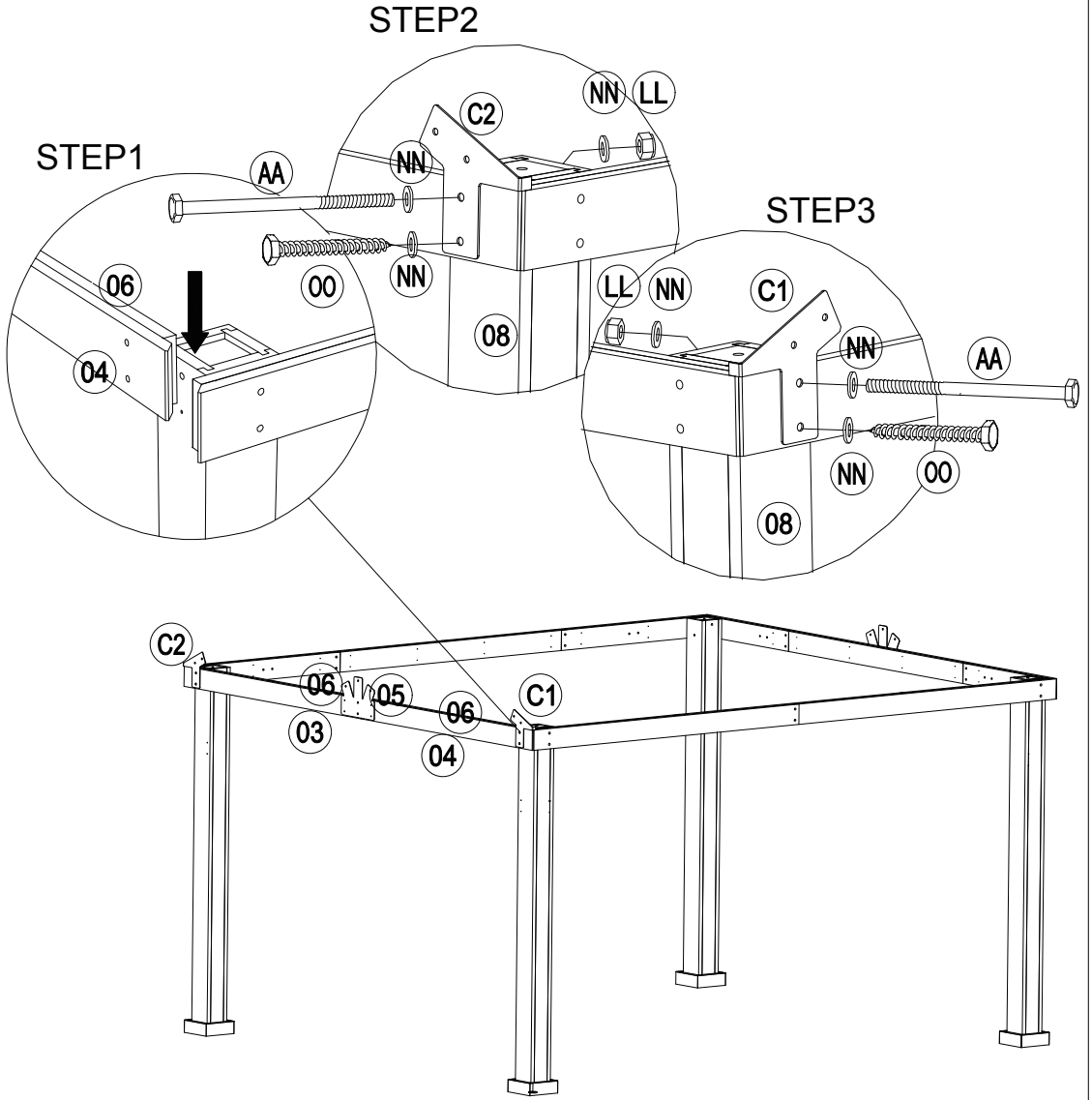

C2 2x

<7>





 NN 12x M10

 LL 4x M10

7

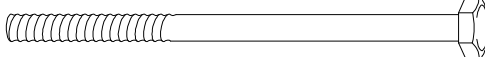
 OO 4x M10X80

 AA 4x M10X205



<8>

10 4x



11 4x



i d1=d2

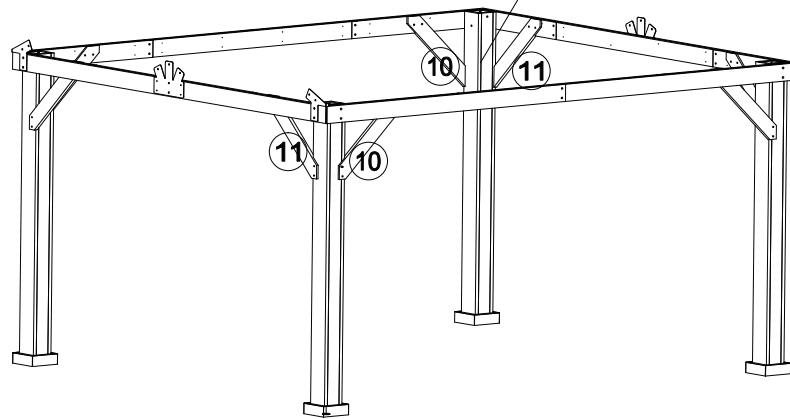
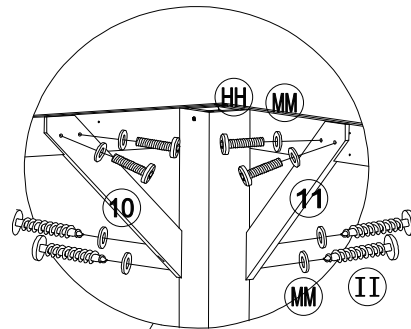
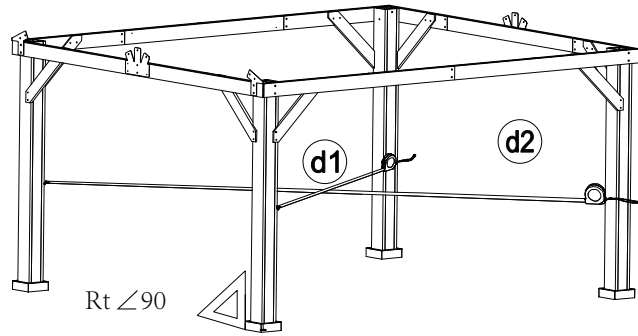

Attention:

Install from the top to bottom when join Arc support 1 (10) and Arc support 2 (11).

8



II 16x

M8X35



MM 32x

M8

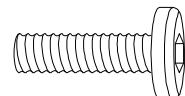

HH 16x

M8x35

# <9>

## Attention:

1. Join Steel pin (S) on the Triangular Support Beam(13) first.
2. Join Triangular Support Beam(13) with Triangular Middle Support Beam(14) and Triangular Frame Slanting Beam(15 ) by using a wooden hammer.

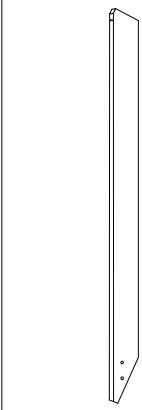

13 4x

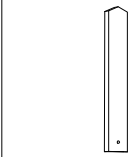

14 2x

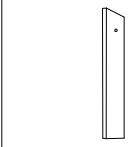

15 4x

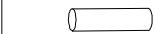

S 12x

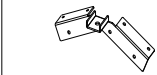

C4 2x

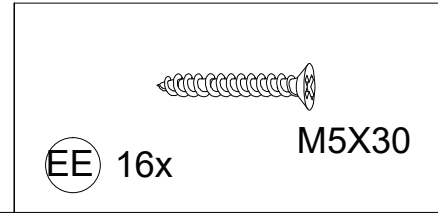
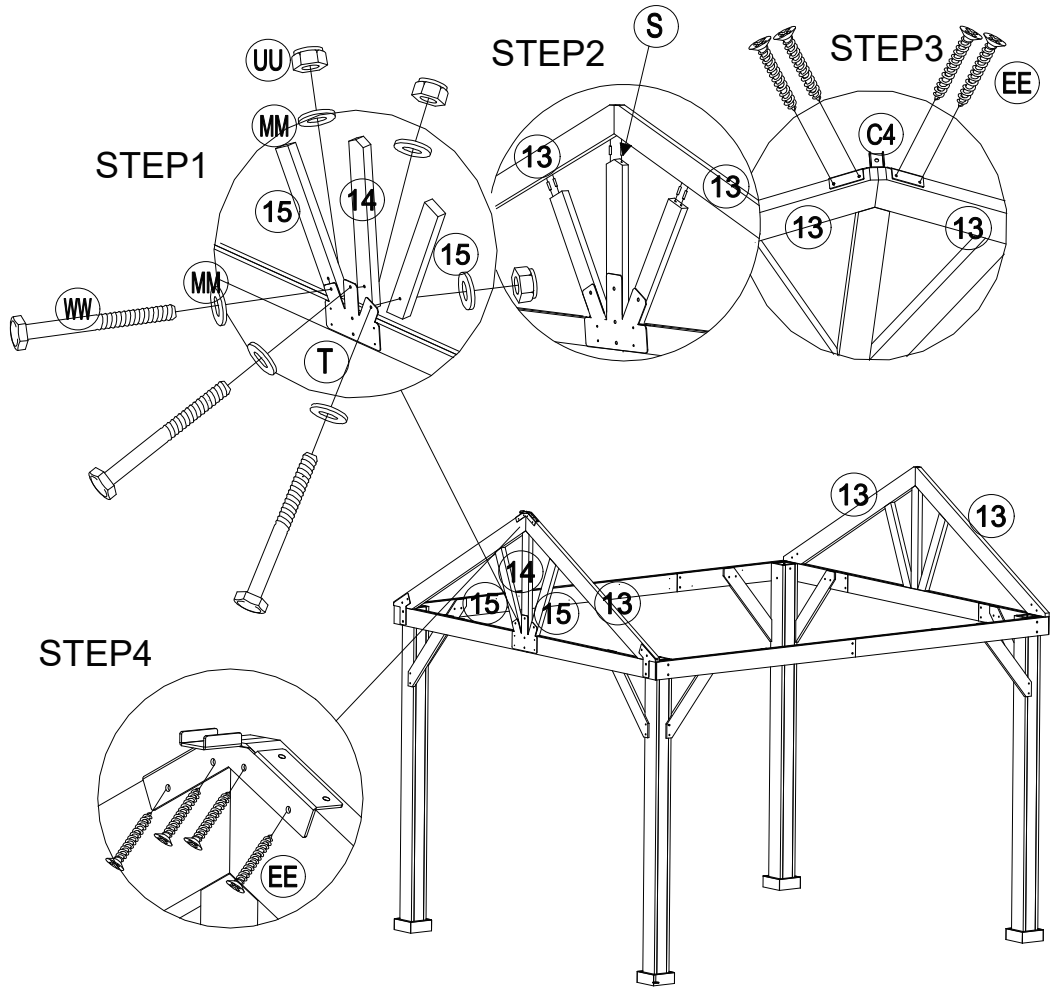

EE 16x M5X30

9

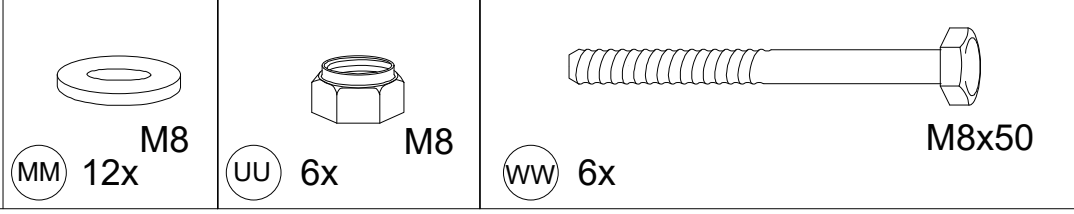

MM 12x M8

UU 6x M8

WW 6x M8x50

<10>



13 4x

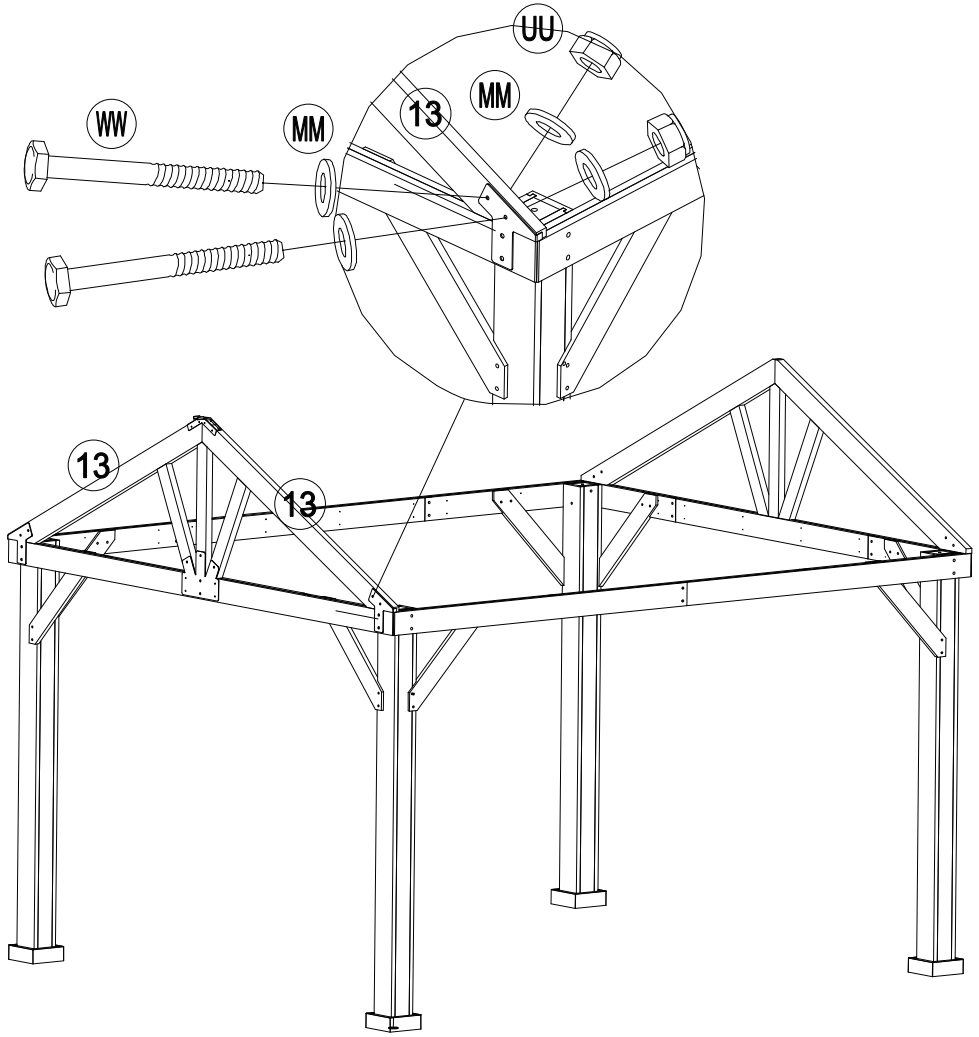

10

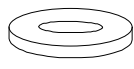

MM 16x M8



UU 8x M8

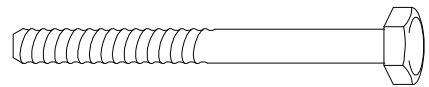

WW 8x M8x50

<11>

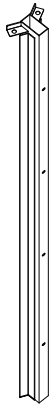

(F1) 1x

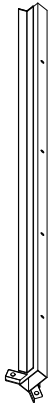

(F2) 1x

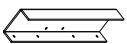

(G1) 1x

11

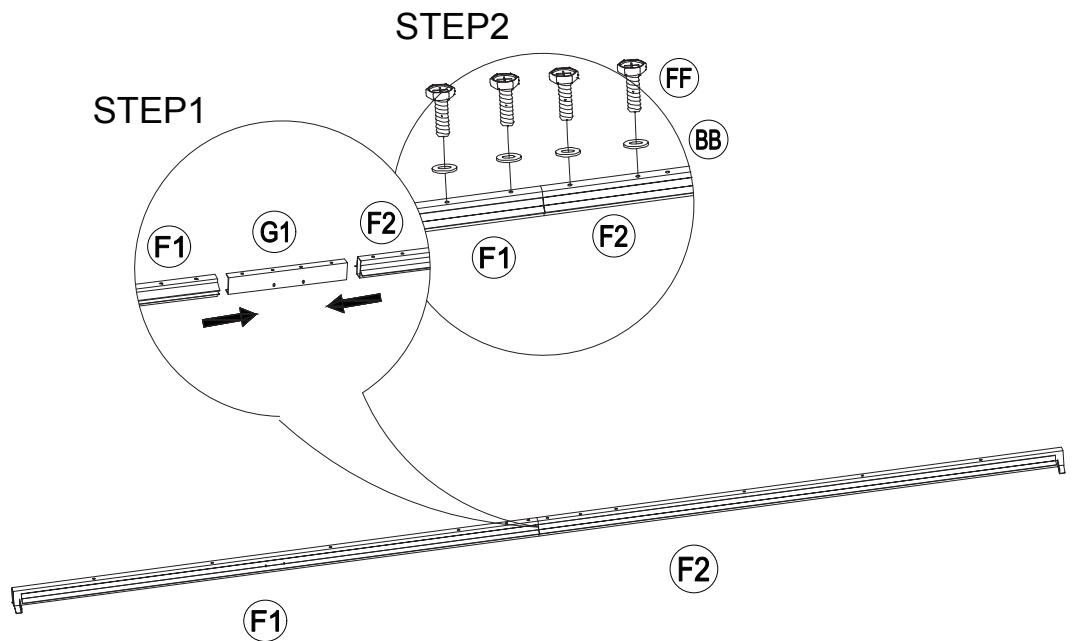

Attention:  
Assemble Big Roof Beam 2(F2) and Big Roof Beam 1(F1) with  
Connector(G1) one by one.



(BB) 4x

M6

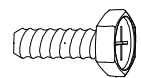

(FF) 4x

M6x15

<12>



F1

F2

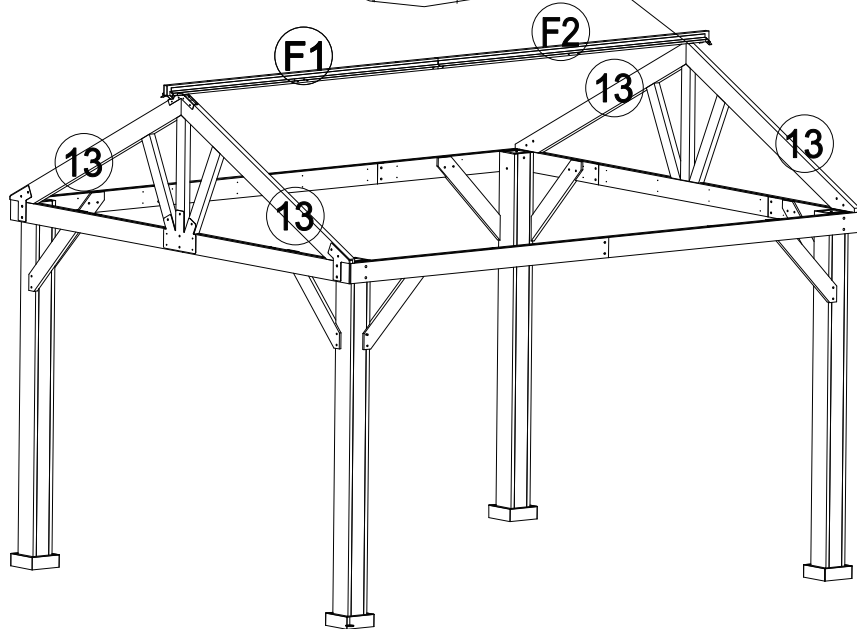
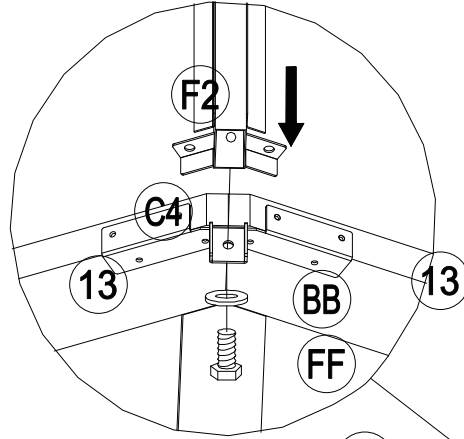

12



M6

BB 2x

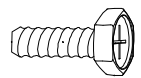

M6x15

FF 2x

<13>



H 6x



I 6x

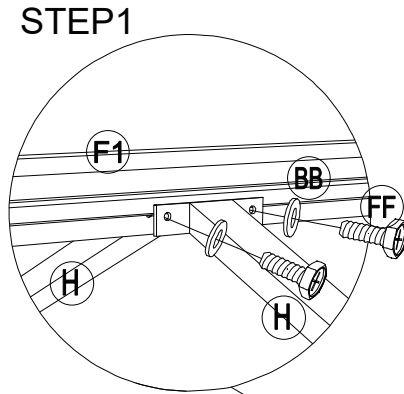

STEP2

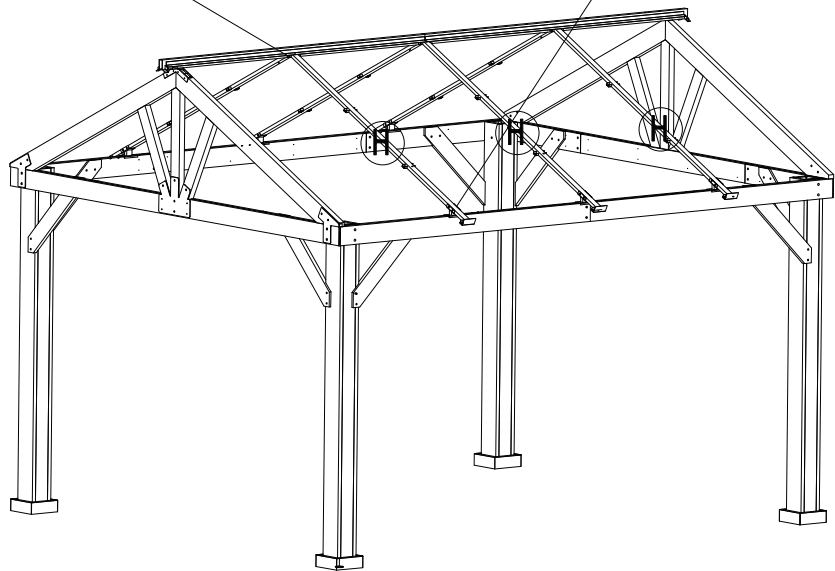
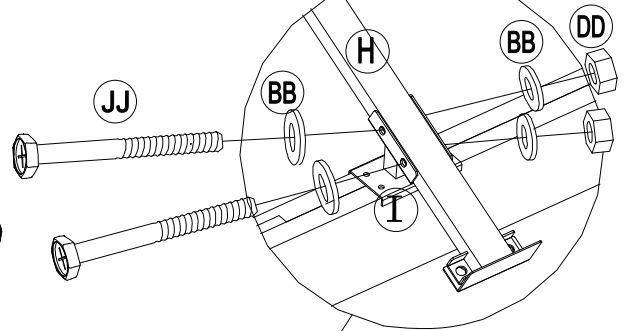

13

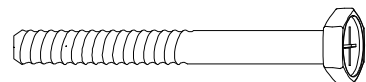

JJ 12x

M6X55



DD 12x

M6



BB 36x

M6

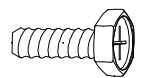

FF 12x

M6x15

<14>



J1 3x

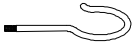

P 1x

STEP1

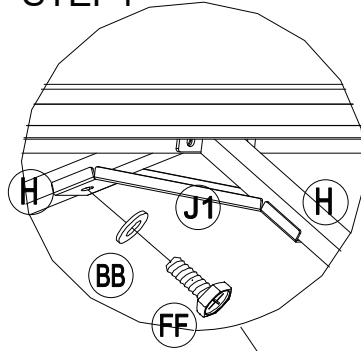

STEP2

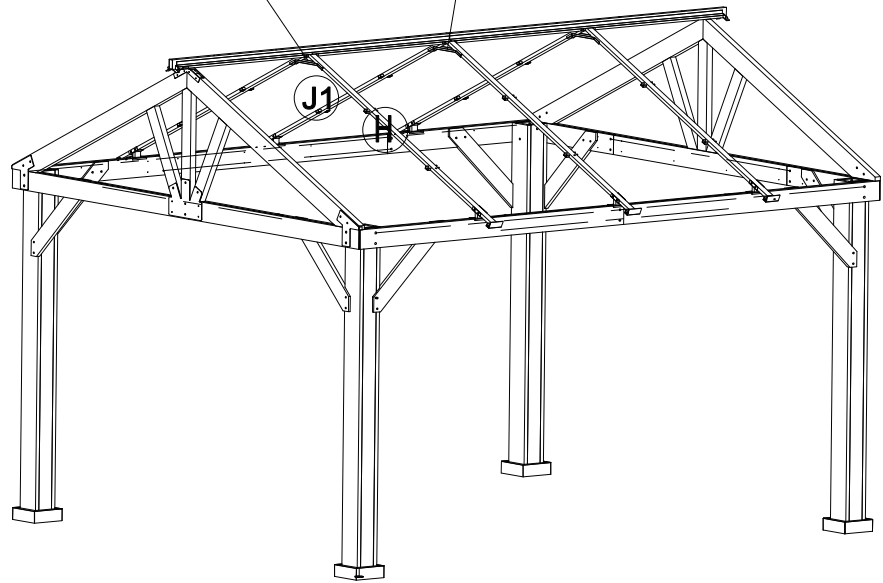
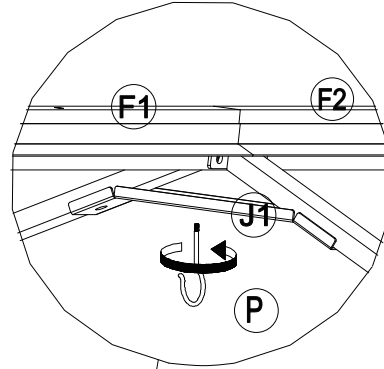

14



M6  
BB 6x

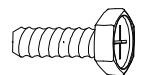

M6x15  
FF 6x

<15>



(N) 8x

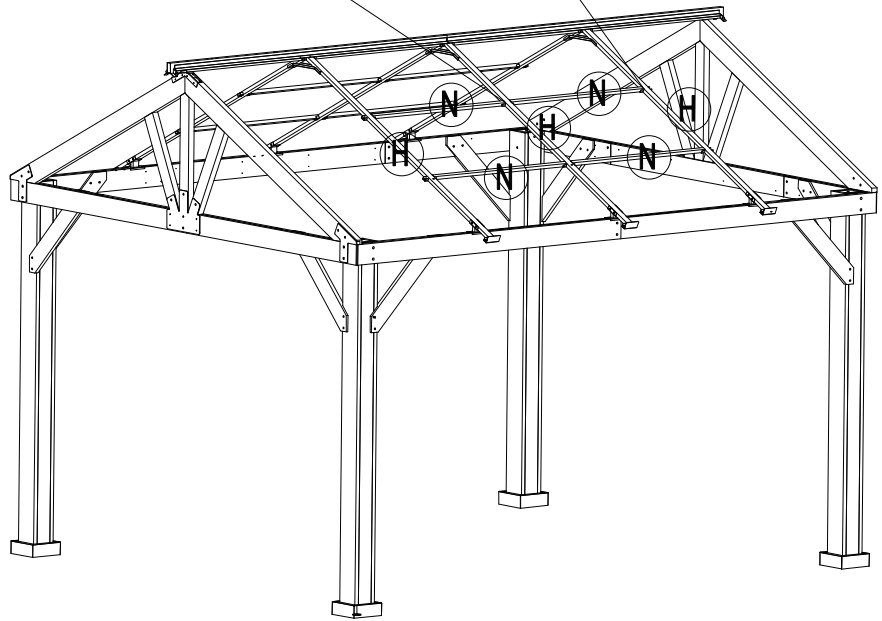
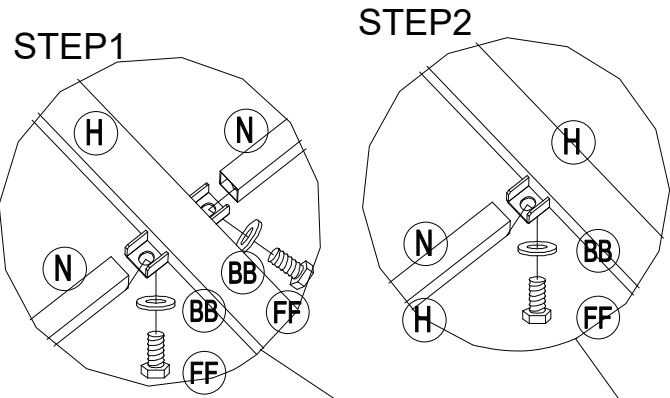

15



M6  
(BB) 16x

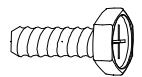

M6x15  
(FF) 16x



<16>

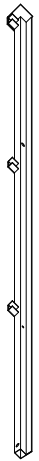

M1 2x

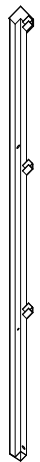

M2 2x

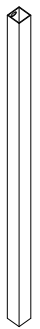

N 8x

16

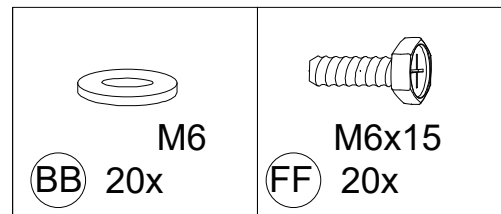
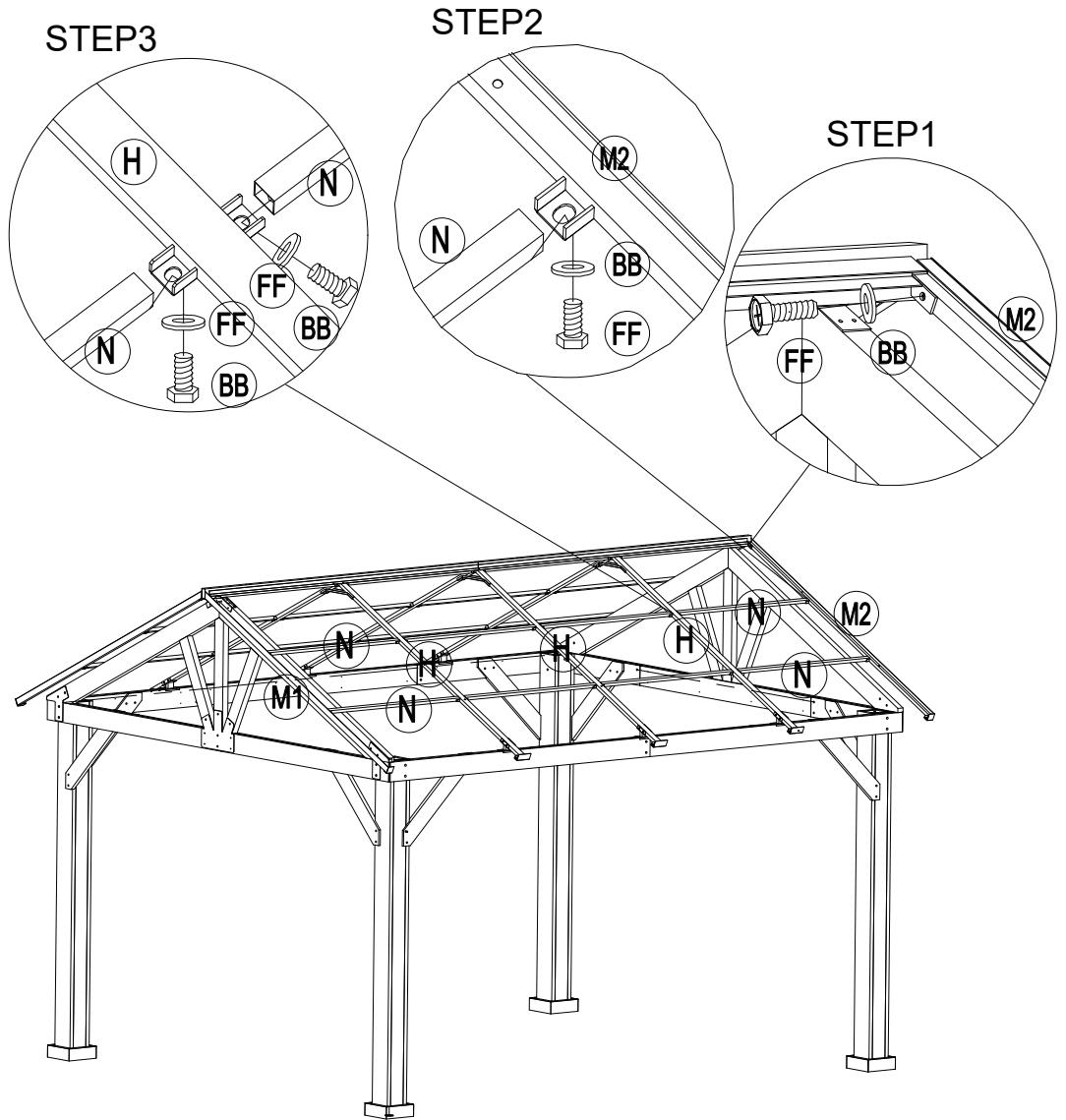

<17>



(L1) 2x



(L2) 2x

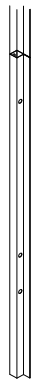

(L3) 2x



(L4) 2x

17

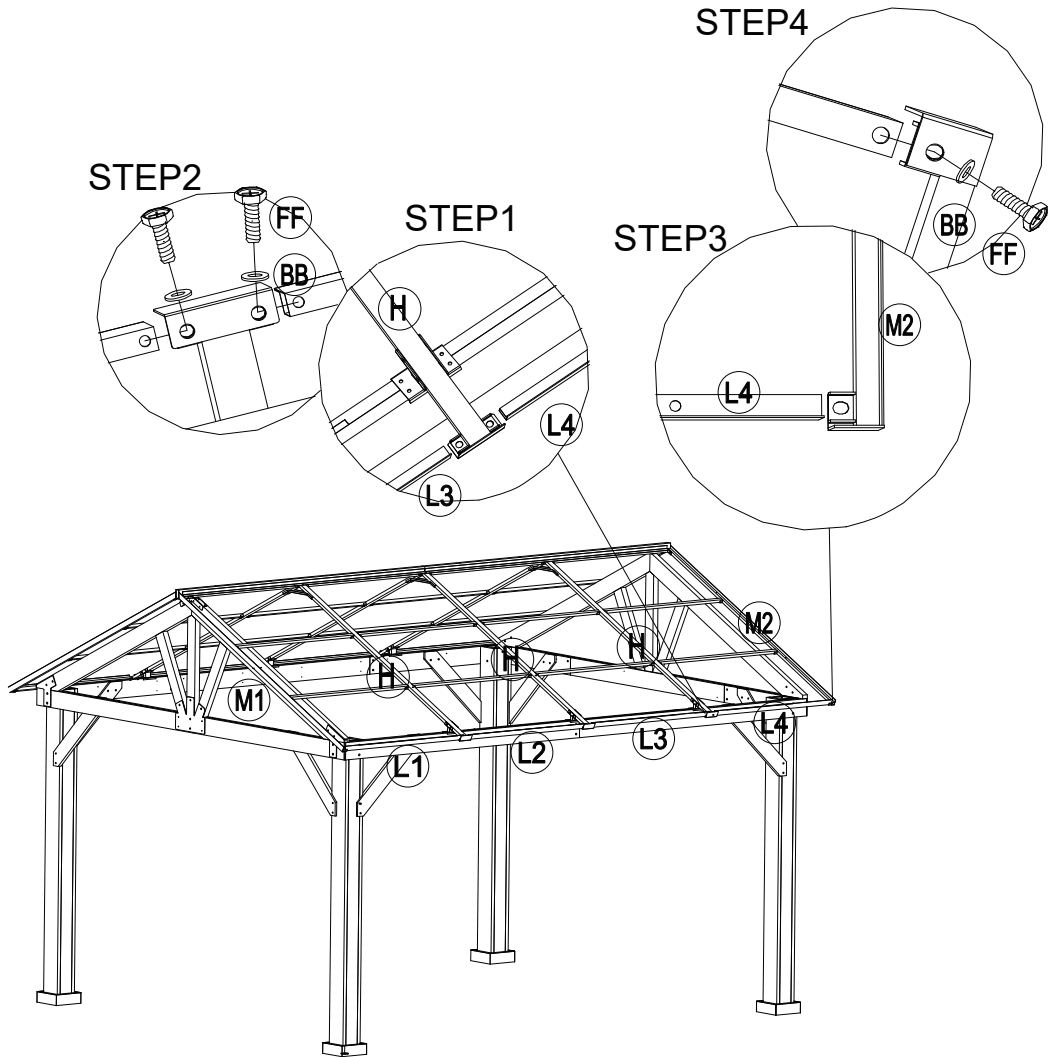

Attention:  
Please make sure that join Big Roof Lower Tube (L1) with the Big Roof Side(M1).



(BB) 16x M6

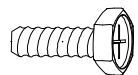

(FF) 16x M6x15

<18>

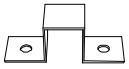

⊙ 8x

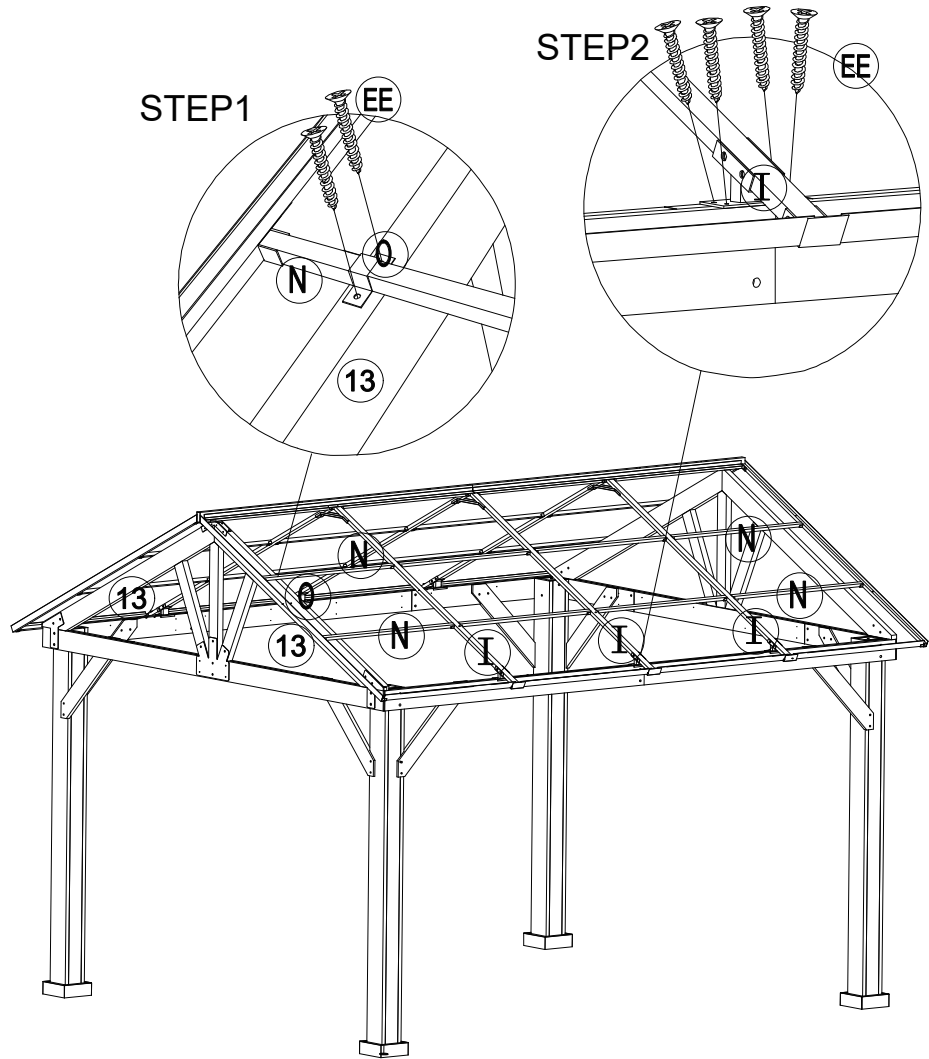

18



⊙ EE 40x

M5x30

<19>

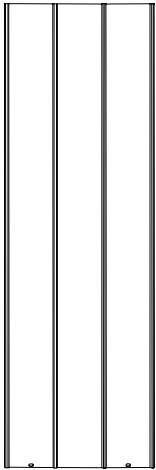

P1 4x

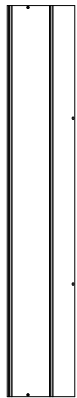

P2 2x



R1 1x

19

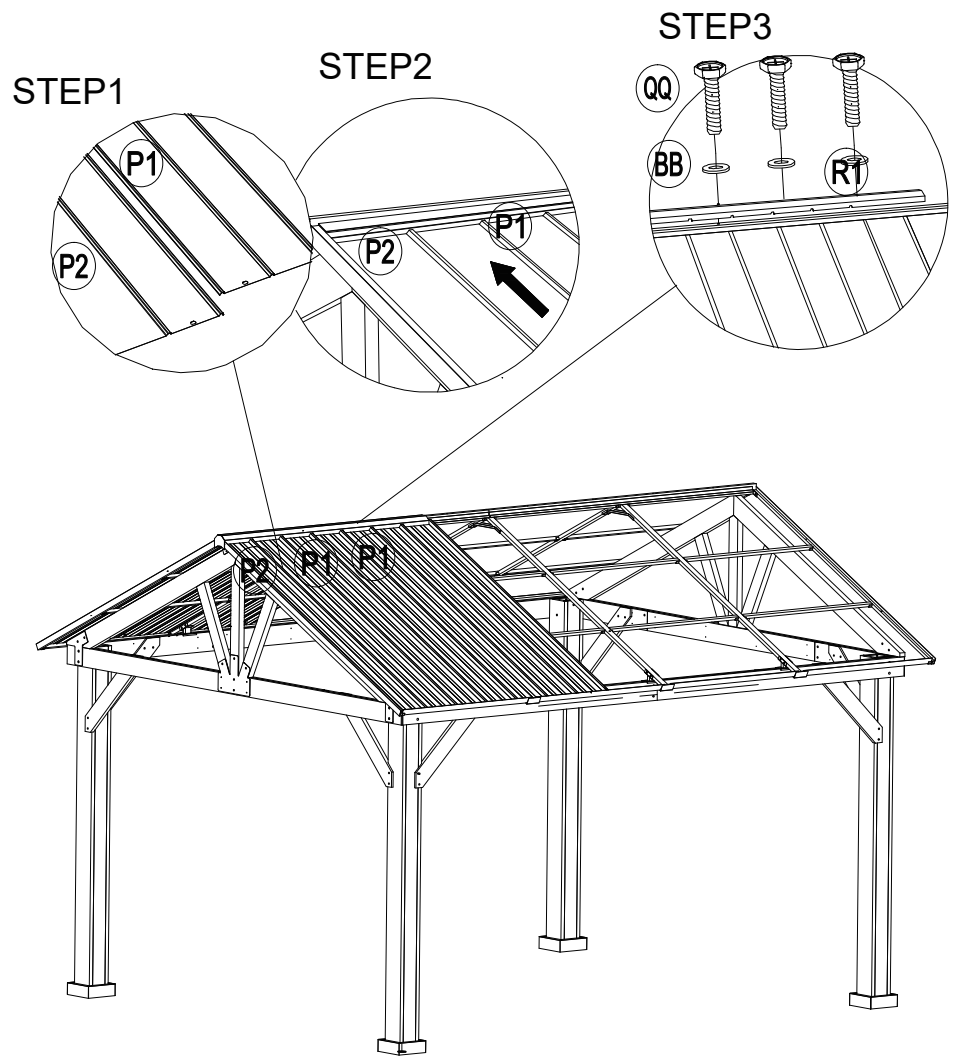

Attention:  
Please assemble the panel with a 2 m adjustable ladder.

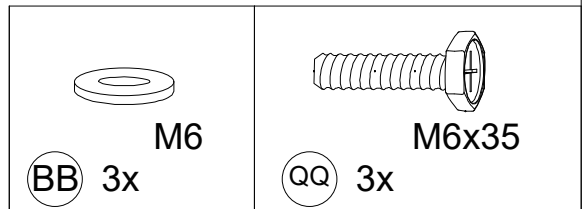

<20>

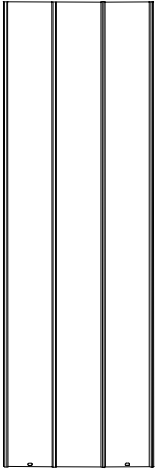

P1 2x



R2 1x

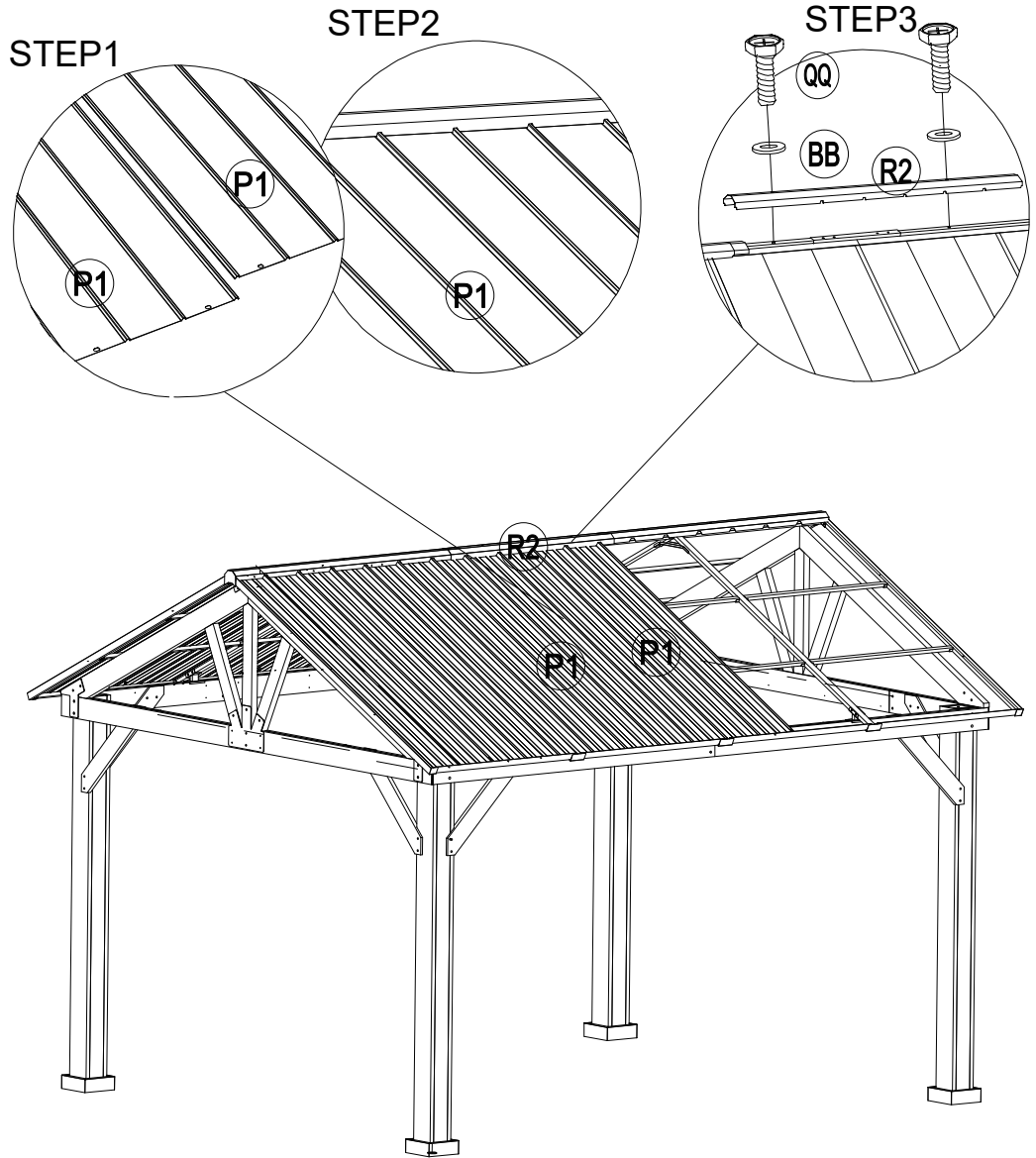

Attention:  
Please assemble the pannel with a 2 m adjustable ladder.

20

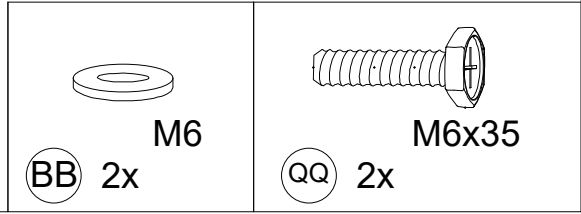

<21>

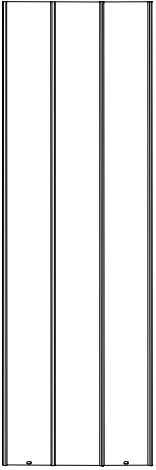

P1 4x

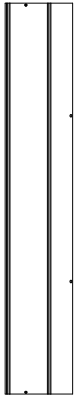

P2 2x



R1 1x

21

STEP1

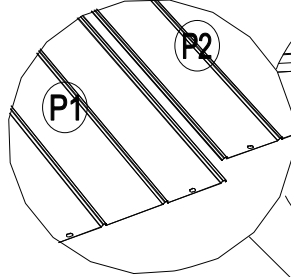

STEP2

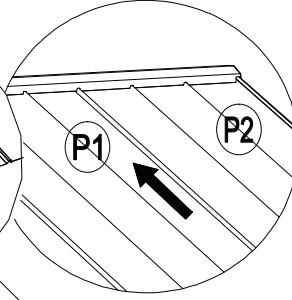

STEP3

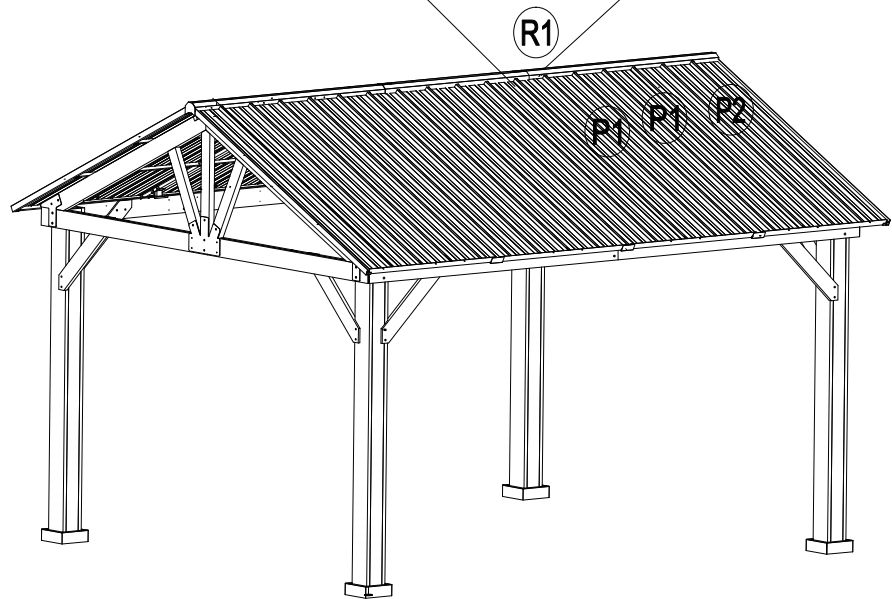
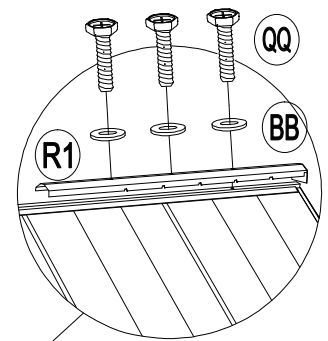

Attention:

Please assemble the pannel with a 2 m adjustable ladder.



BB 3x

M6

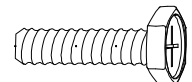

QQ 3x

M6x35

<22>



Q 6x

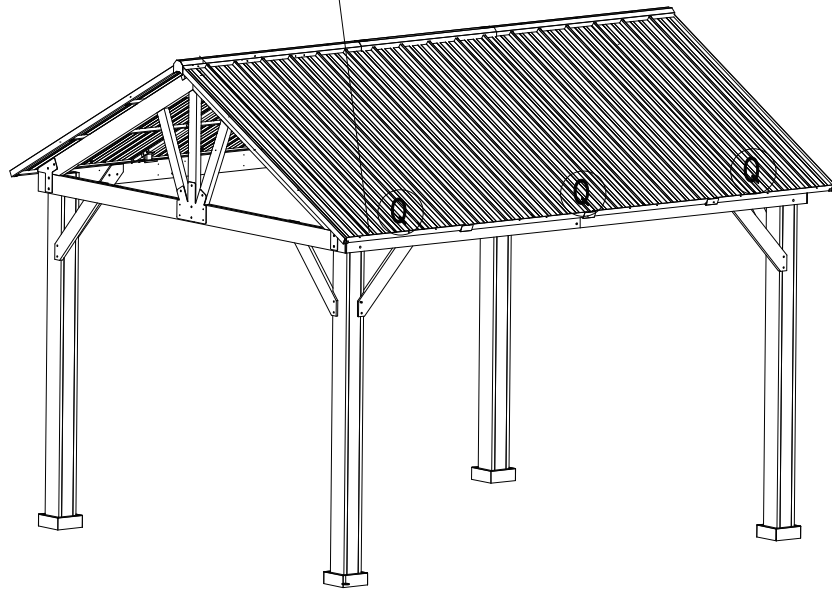
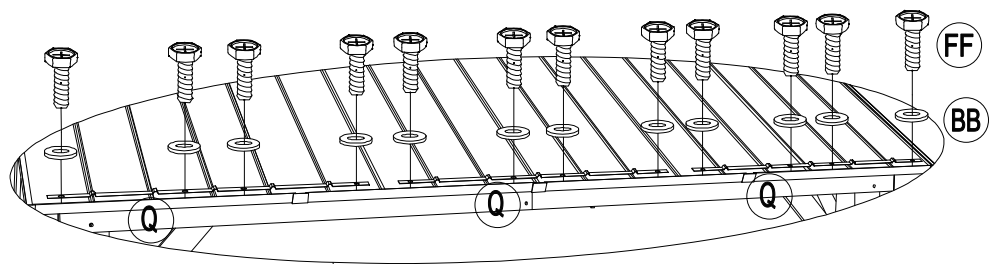

22

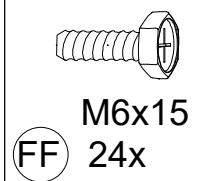
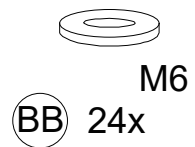

<23>



U 4x

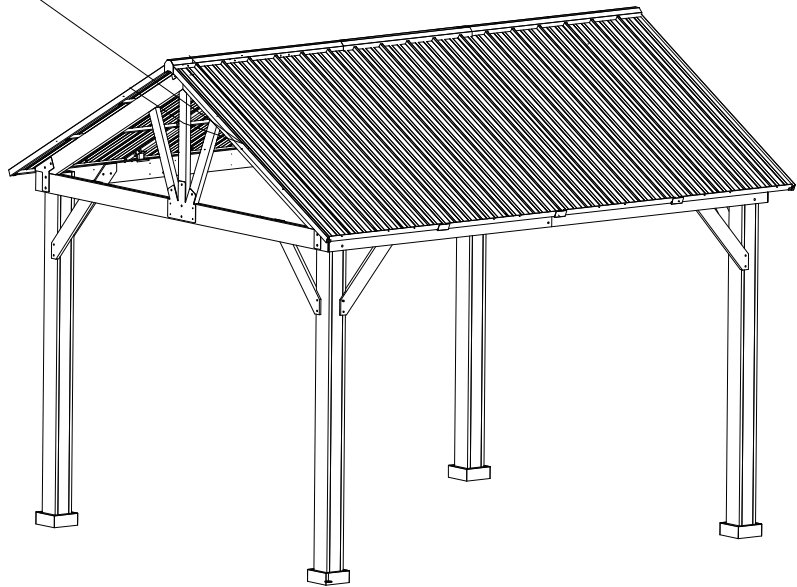
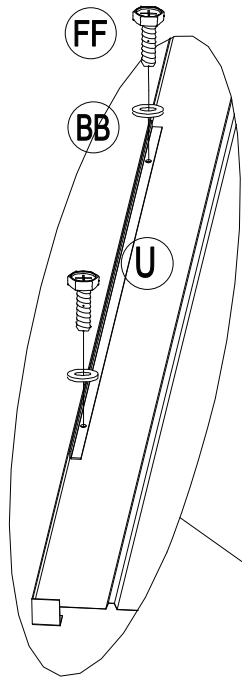

23



BB 8x M6

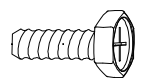

FF 8x M6x15



<24>

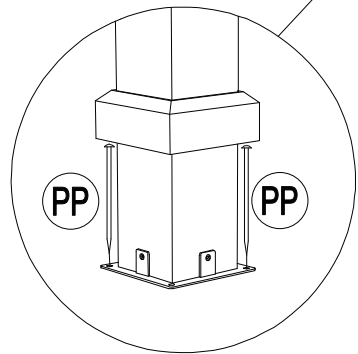
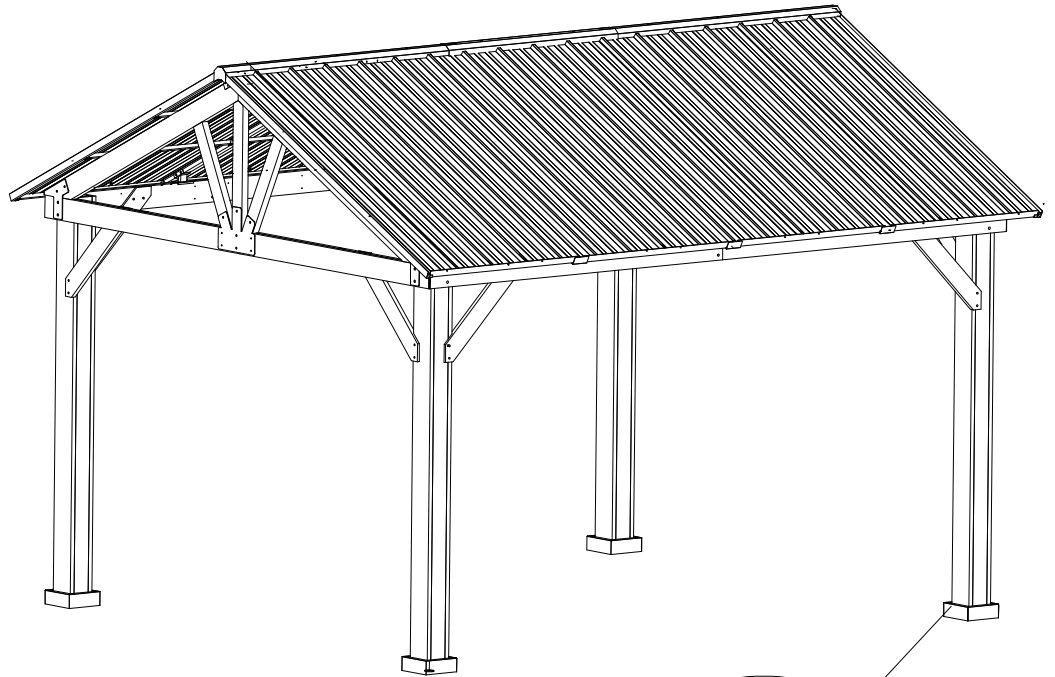

24

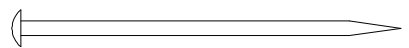

PP Ø8X180  
8x