

**ATTENTION:**

1. Please check the manual carefully and make sure you have received all of the parts.
2. If there is any missing part, please let us know the letter of the parts you need.
3. If there is any damage, please send clear photos. We will check and offer you the best solution soon.
4. If you encounter any problems, please feel free to send us a message.

We'll be happy to propose solutions for you, so please do not worry.







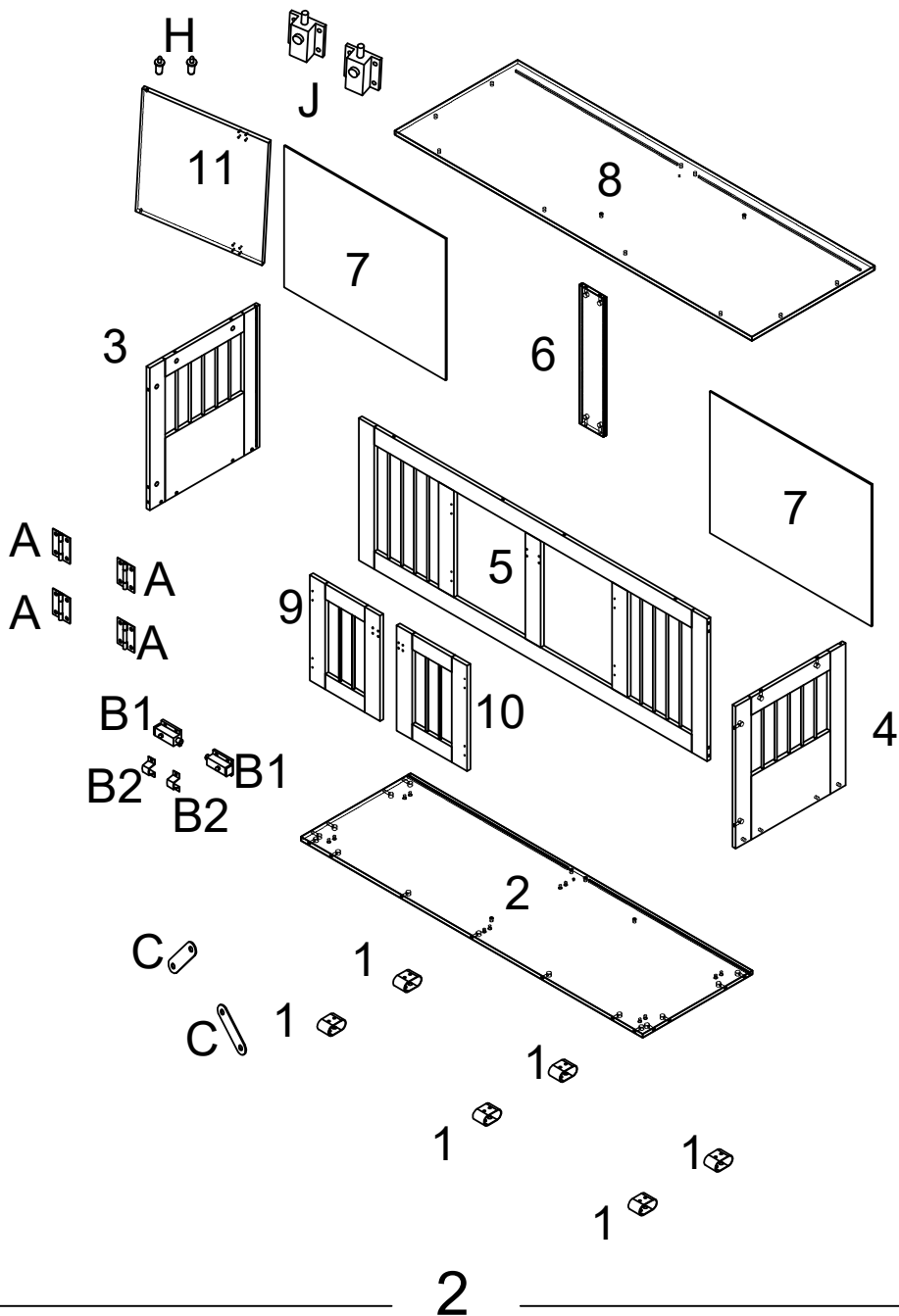

**UESR'S MANUAL**

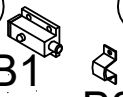
**WQHM097**



# Explosion view

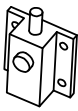

# Hardware List

- |   |  |  |  |  |  |
|---|--|--|--|--|--|
| <br>A<br>(4pcs)  | <br>B<br>B1<br>B2<br>(2pcs) | <br>C<br>(2pcs) | <br>D<br>M6*12<br>(12pcs) | <br>E<br>M4*14<br>(40pcs) | <br>F<br>(31pcs) |
| <br>G<br>(31pcs) | <br>H<br>(2pcs)             | <br>J<br>(2pcs) | <br>M4<br>(1pcs)          |  |  |

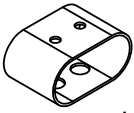
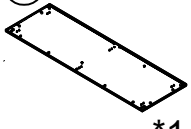
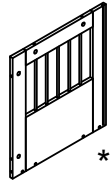
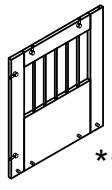
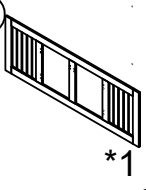
# Panel List

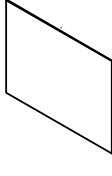
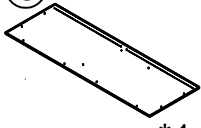
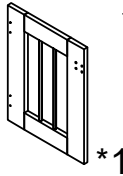
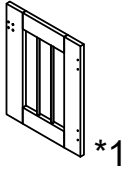
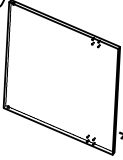
- |  |  |  |  |  |
|--|--|--|--|--|
| <br>1<br>*6    | <br>2<br>*1   | <br>3<br>*1   | <br>4<br>*1   | <br>5<br>*1    |
| <br>6<br>*1 | <br>7<br>*2 | <br>8<br>*1 | <br>9<br>*1 | <br>10<br>*1 |
| <br>11<br>*1 |  |  |  |  |

# Assembling the unit with camlocks and wood dowels.

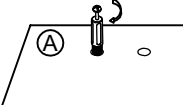
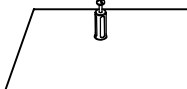
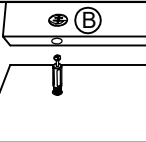
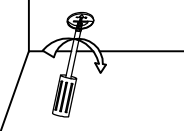
		<p>Arrow must face hole</p> 	
<p>Gently screw cam bolt into the threaded anchor.</p>		<p>Gently attach the dowel to the second panel and insert it into the hole.</p>	<p>Screw the camloc firmly into locked position.</p>

## Assembly instructions

### Step 1

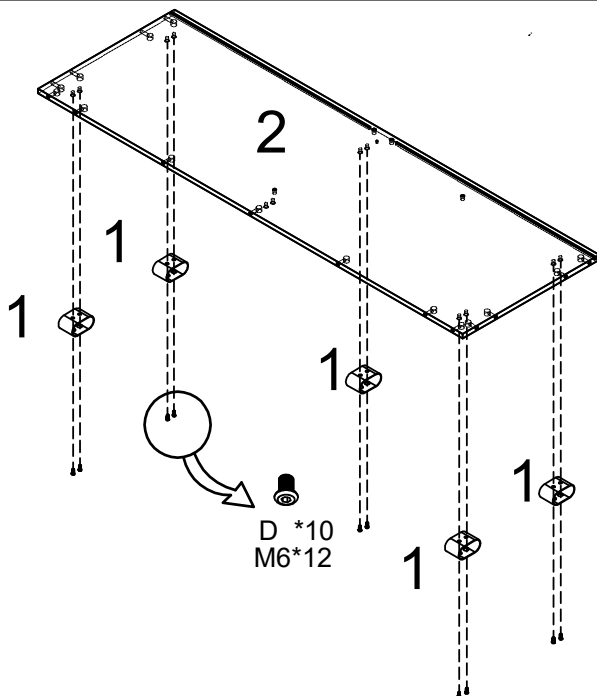

  
 D \*10  
 M6\*12

D \*10  
 M6\*12

## Step 2

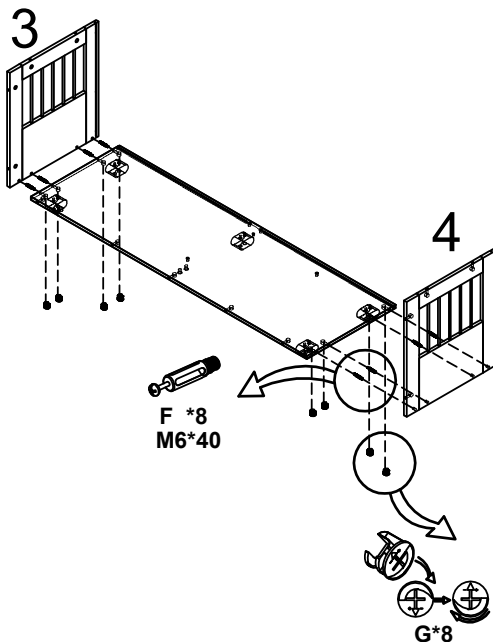

## Step 3

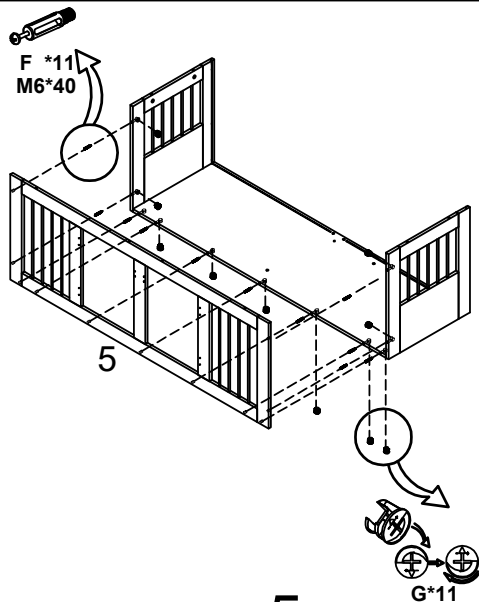

# Step 4

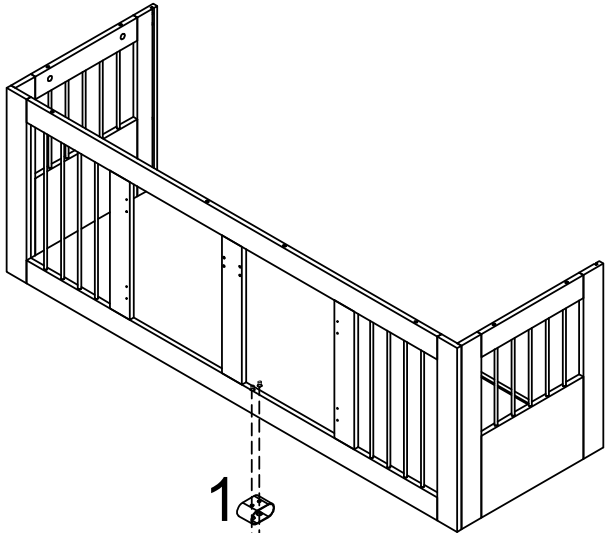

D \*2  
M6\*12

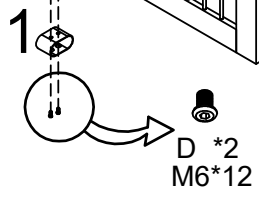

# Step 5

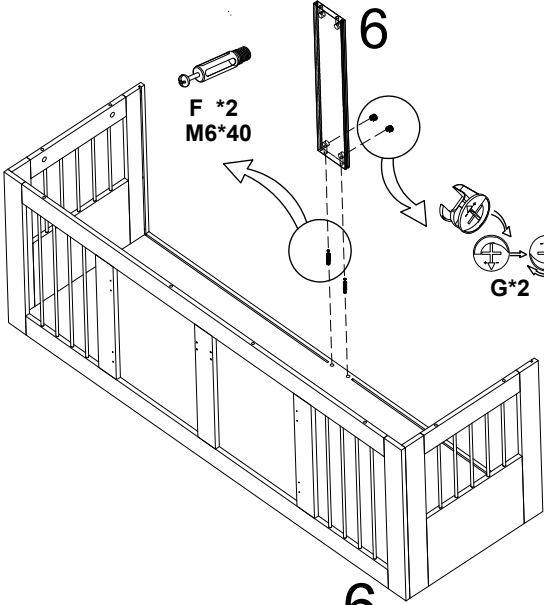

G \*2  
Ø15

6

# Step 6

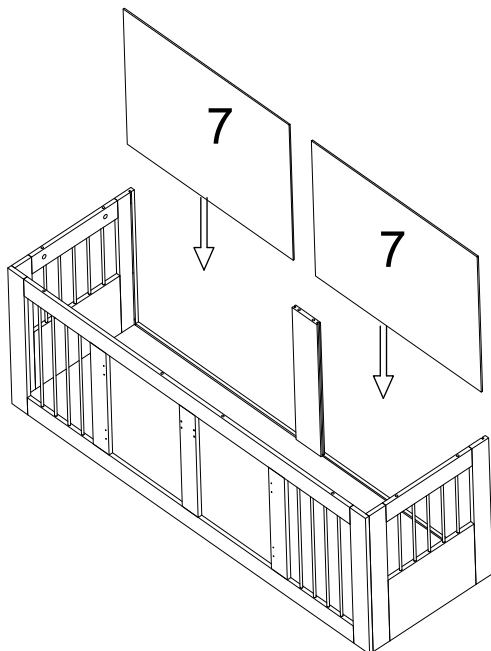

# Step 7

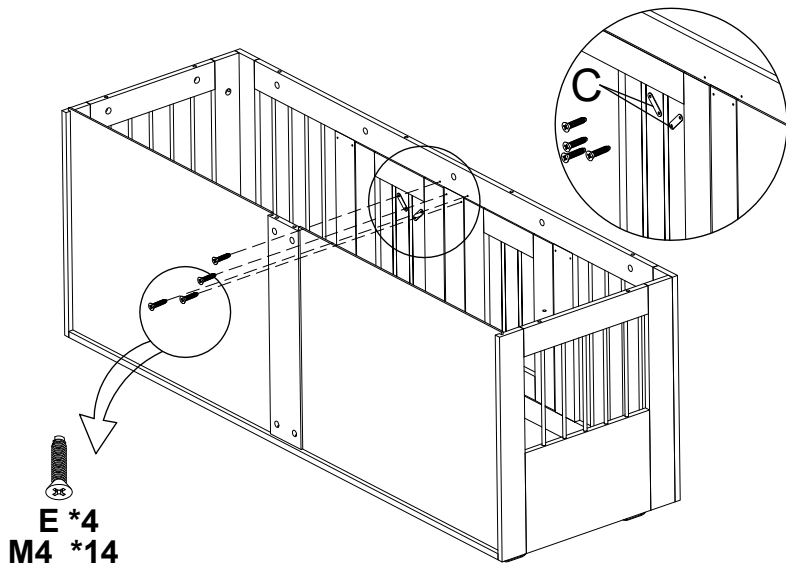

# Step 8

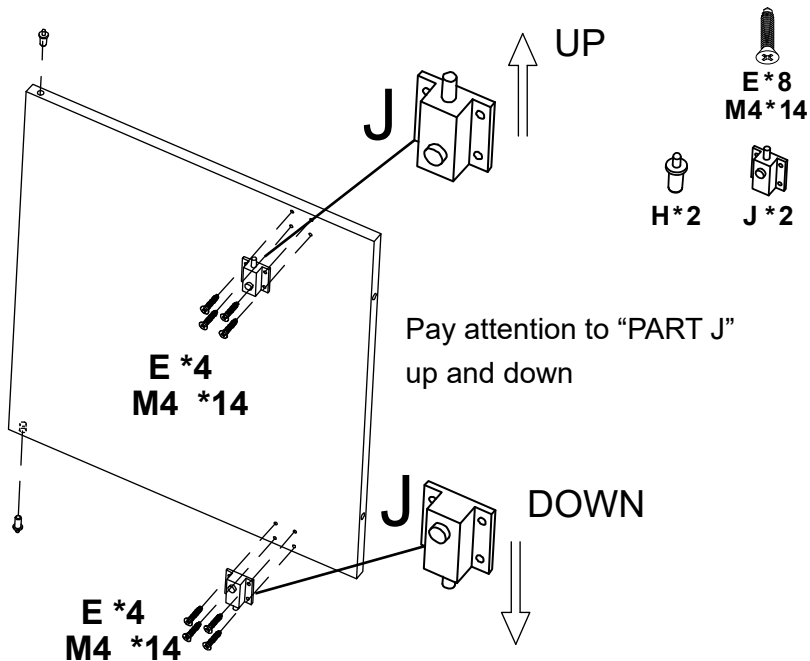
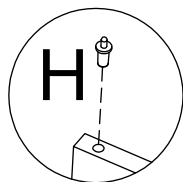

# Step 9

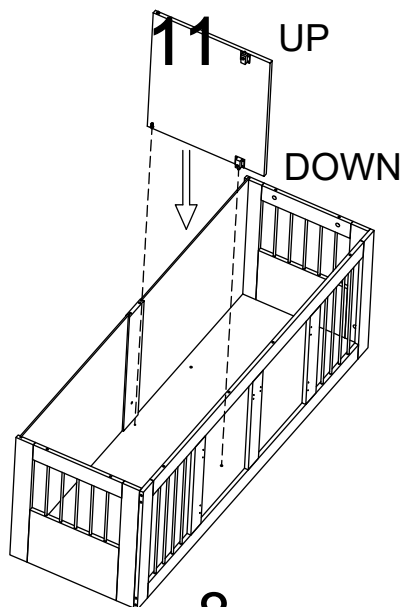



# Step 10

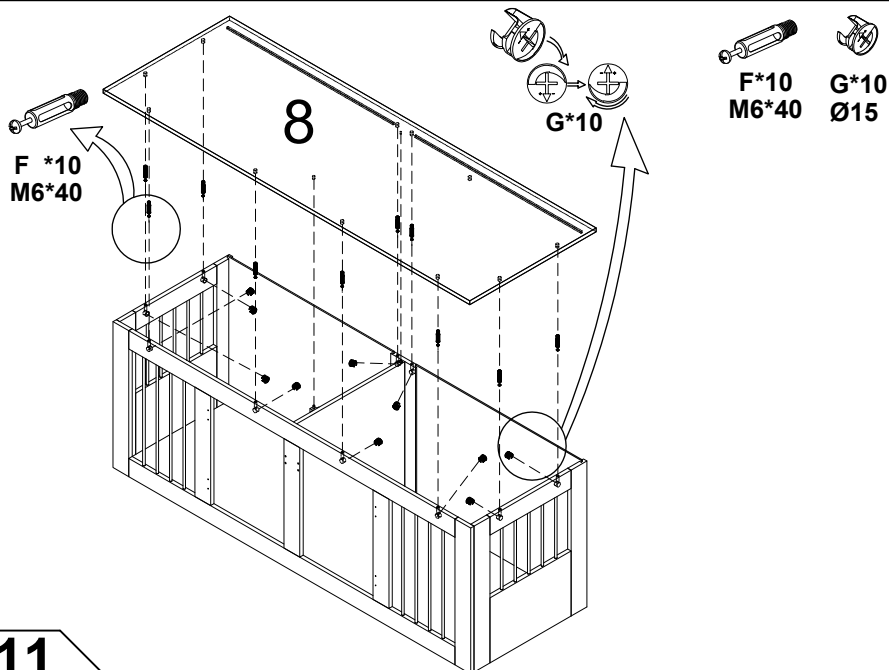

# Step 11

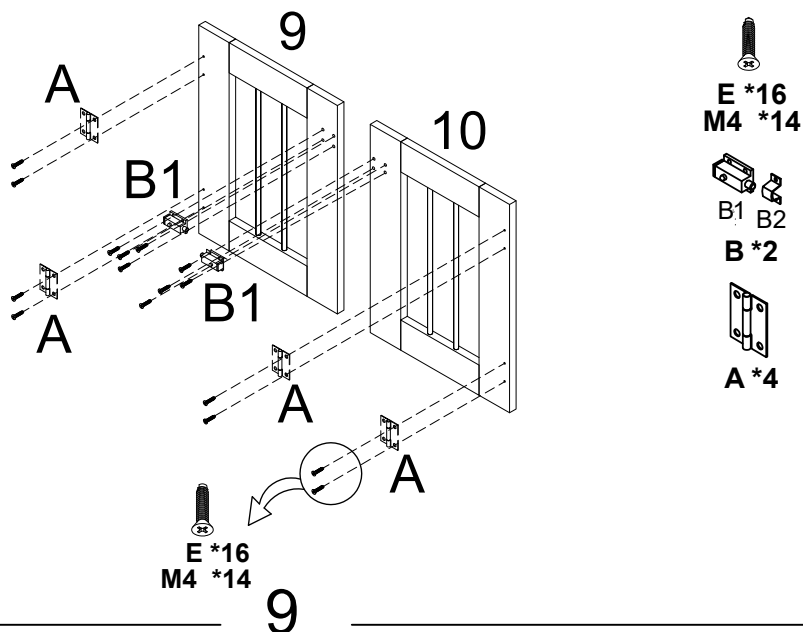

# Step 12

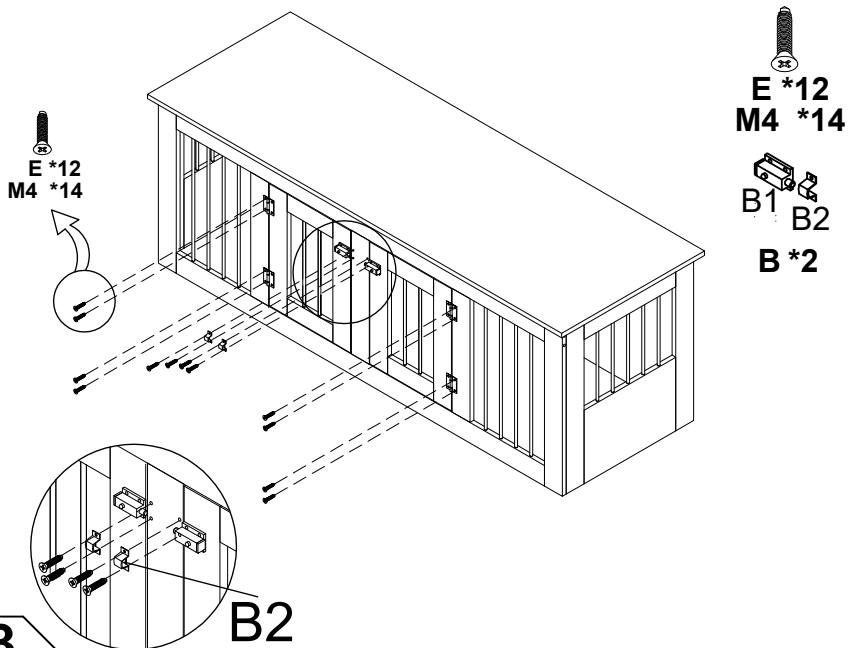

# Step 13

