

WQG-038BK

INSTRUCTION MANUAL





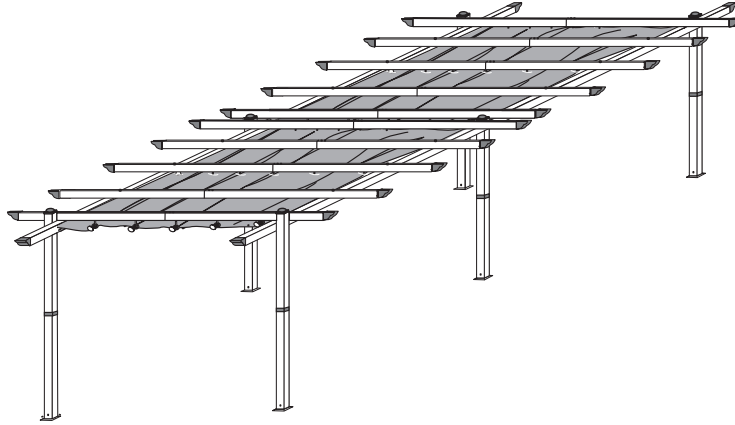

12'x20'Gazebo Garden Pergola

Attention:

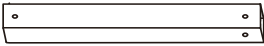
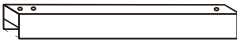
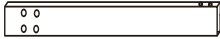







1. Please fix all the screws first, do not lock off, after assembling is full completed, lock all at once finally.
2. Please check the manual carefully and make sure you have received all the parts.
3. If there is any missing, please let us know the letter of the parts you need.
4. If there is any damage, please send clear photos to us, we will check and offer you best solution soon.

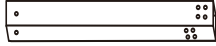
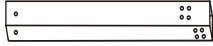
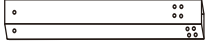
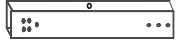

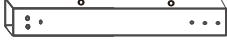
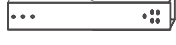
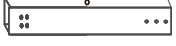

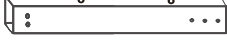
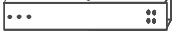
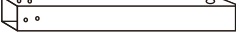
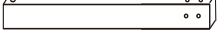







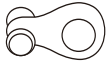

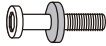

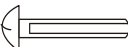

Parts List (BOX A)

PART NO	DESCRIPTION	QTY
A1		6
D		4
F1		4
F2		4
G		2
H		10
U		2
V		24

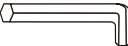
Parts List (BOX B)

PART NO	DESCRIPTION	QTY
A2		2
B1		2
B2		2
C		1
C1		1
C2		1
C3		1
E		1
E1		1
E2		1
E3		1
S1		4
S2		4
K		24
I		2
L		8
M		20

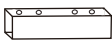
Parts List (BOX B)

PART NO	DESCRIPTION	QTY
N		2
O	 M6 × 75	12
P	 M6 × 45	56
R	 M6 × 12	68
AC		4
Z1		4
T		6
W		6
X	 M6 × 30	4
Y		6
Z		12
AA		1
AB		1
AF		2
AD		4
AE		6
AH		4

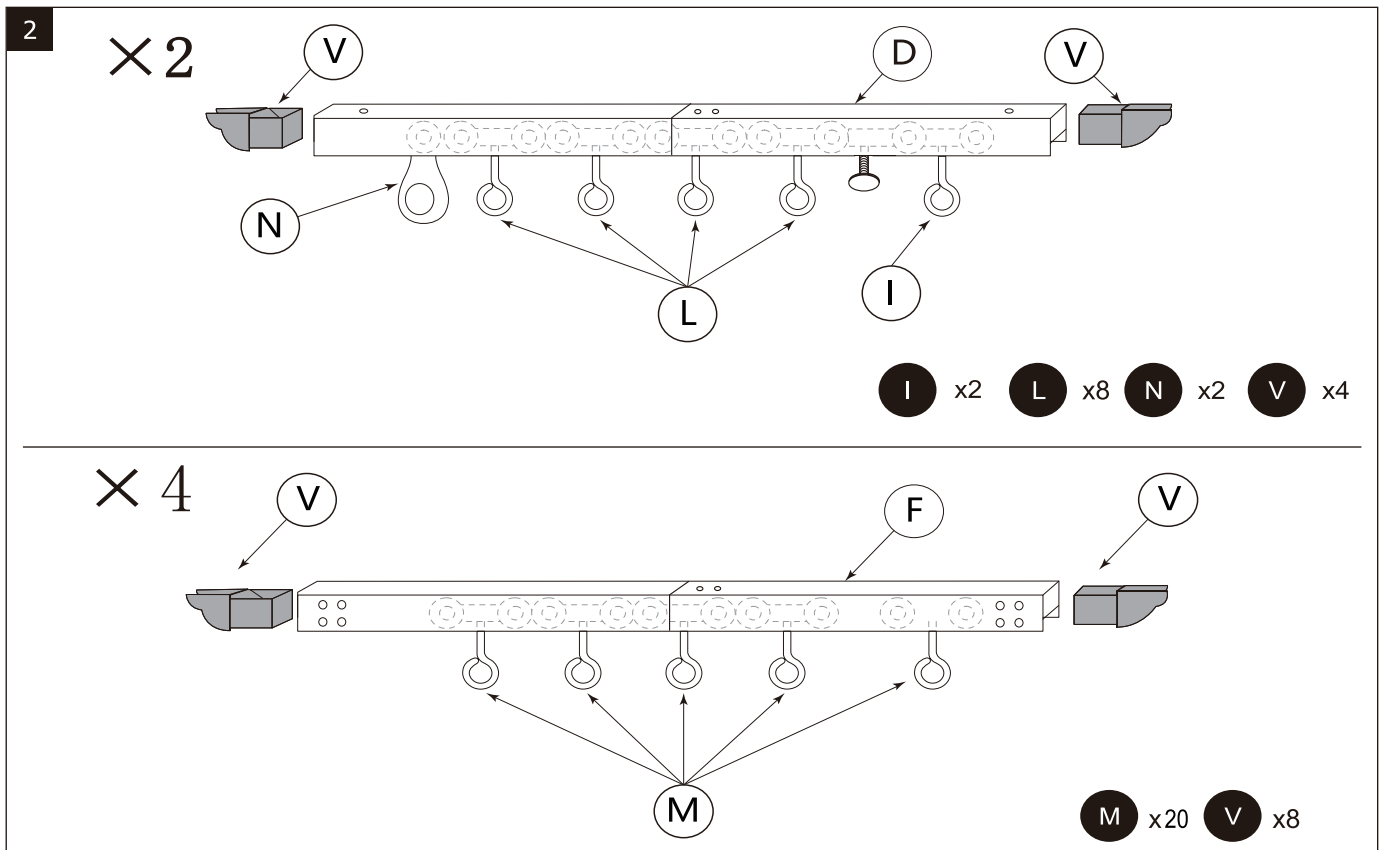
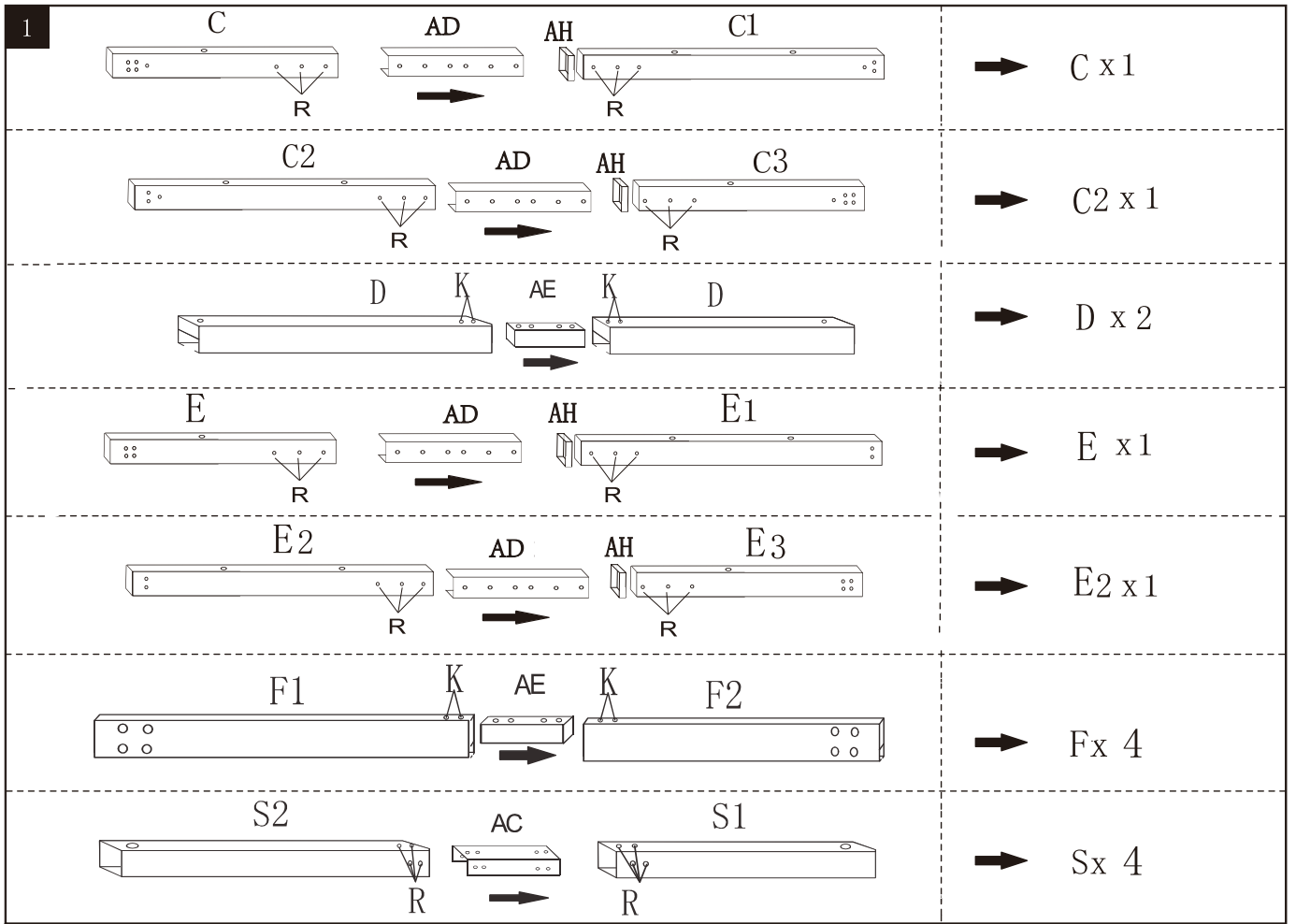

3

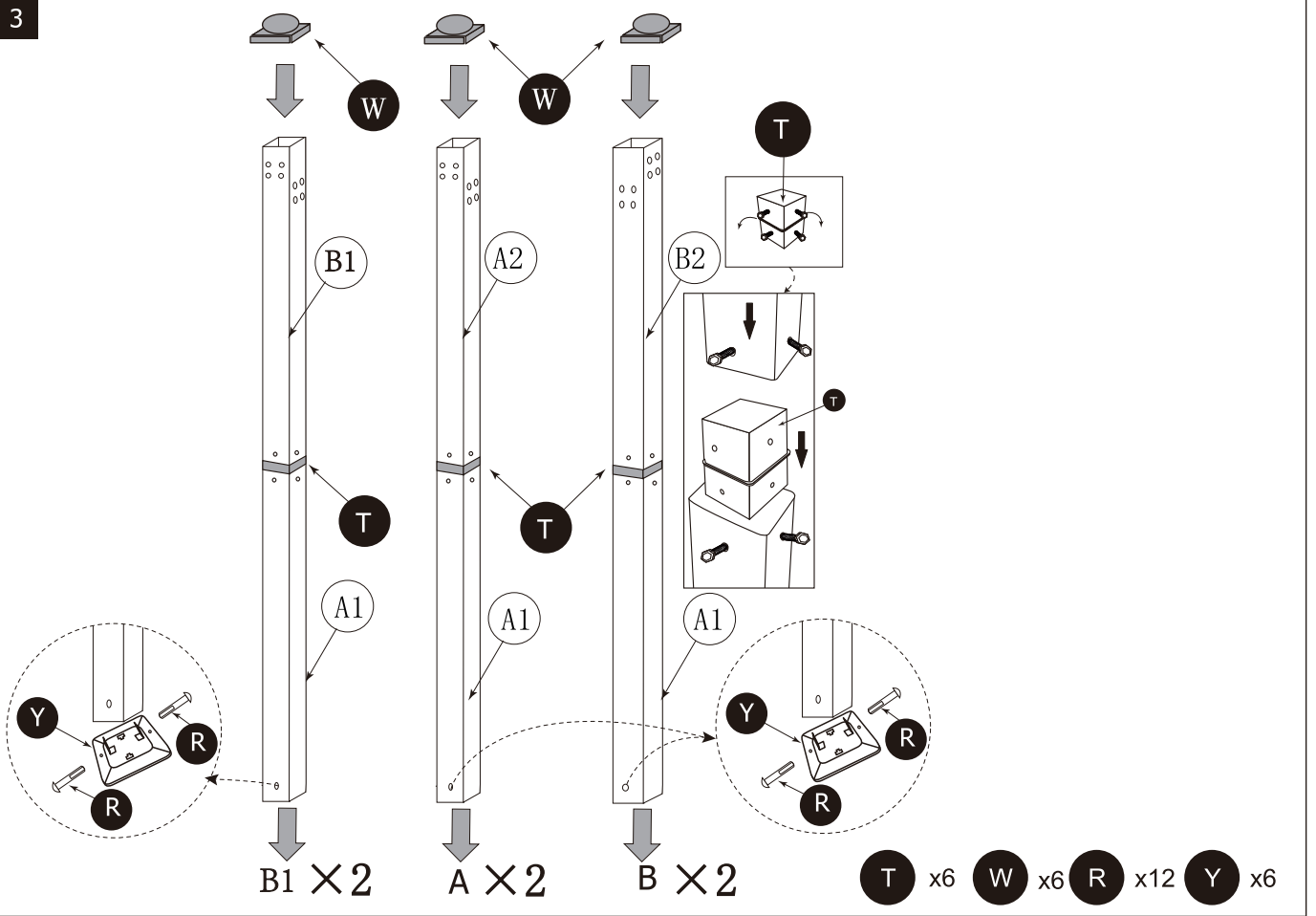

4

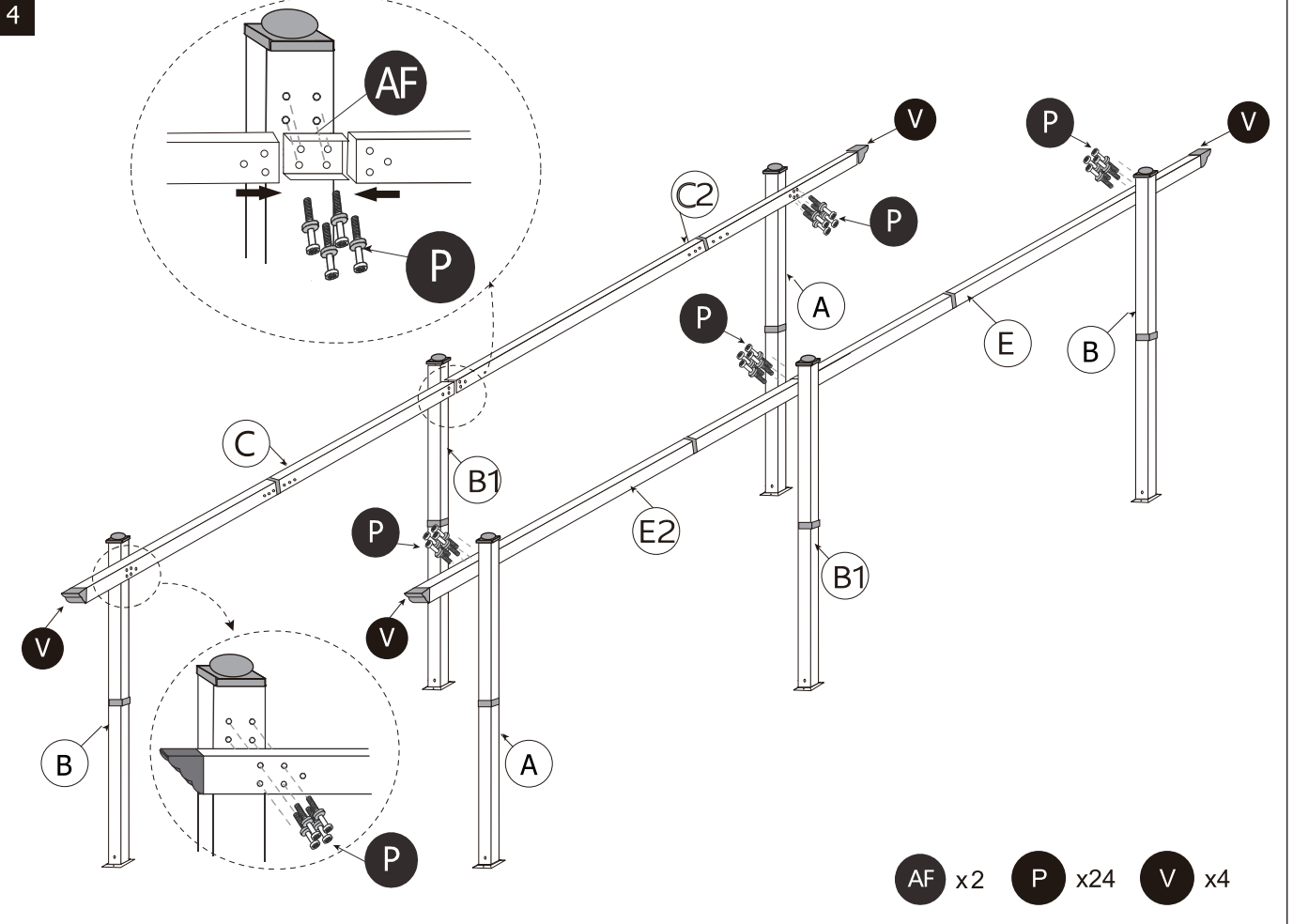

5

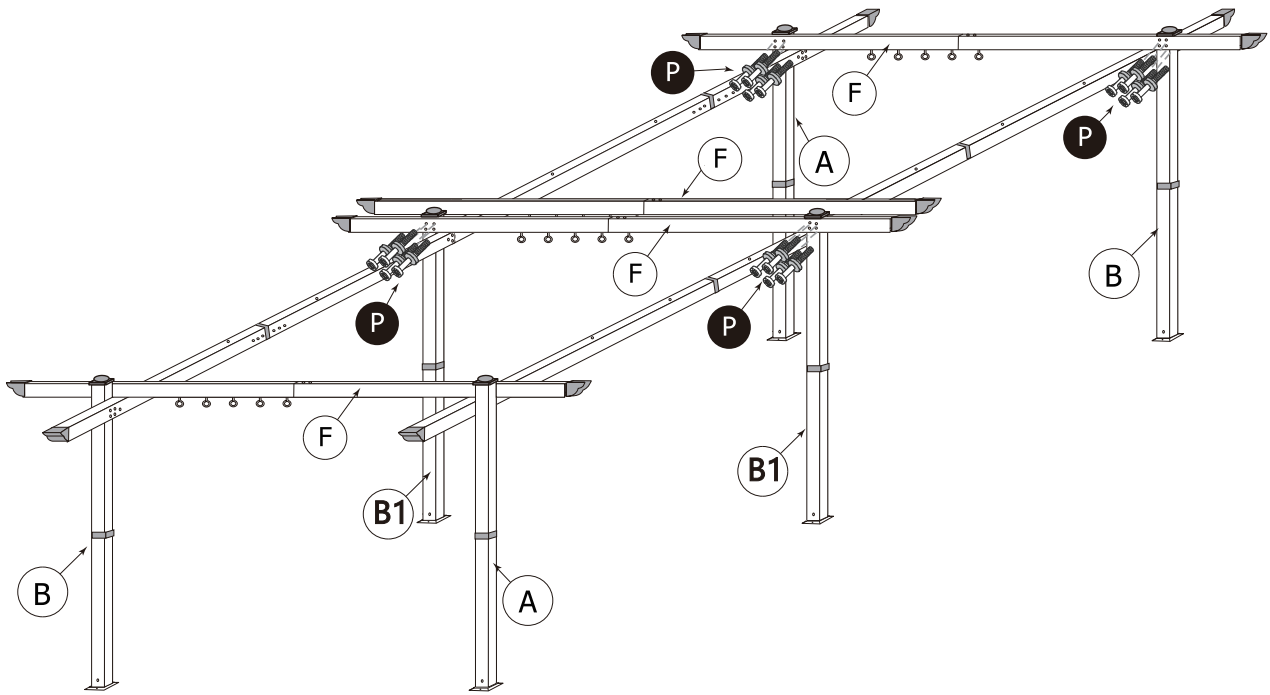

P x32

6

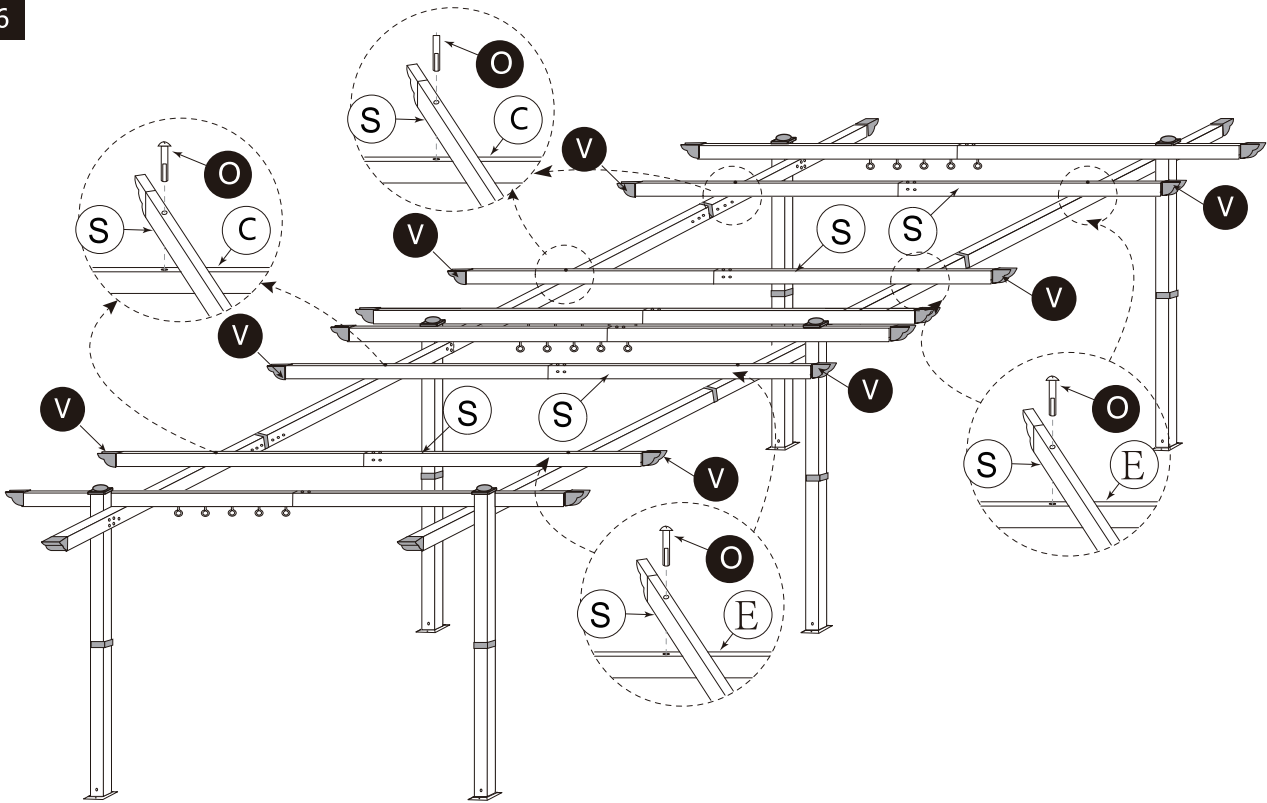

O x8

V x8

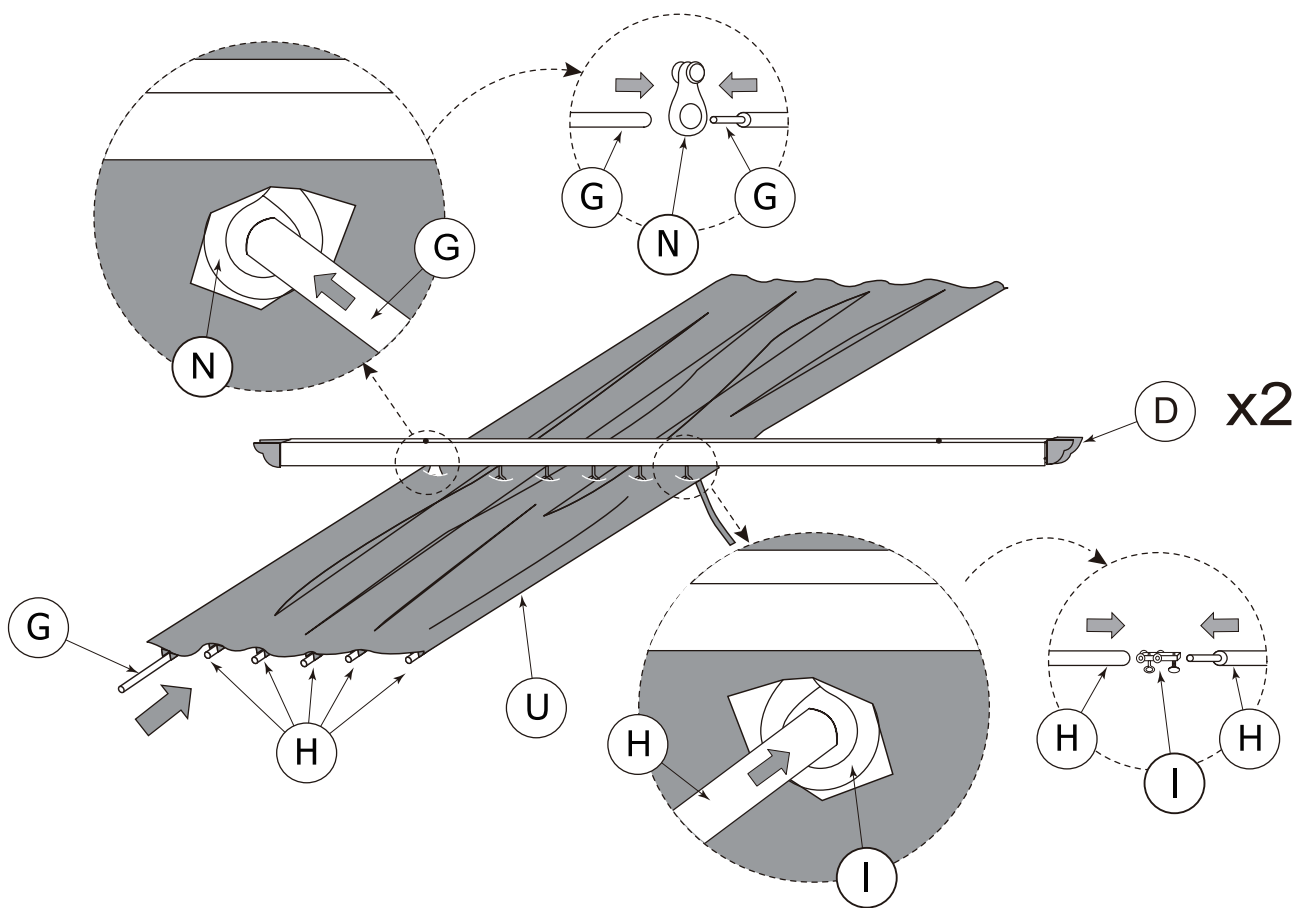

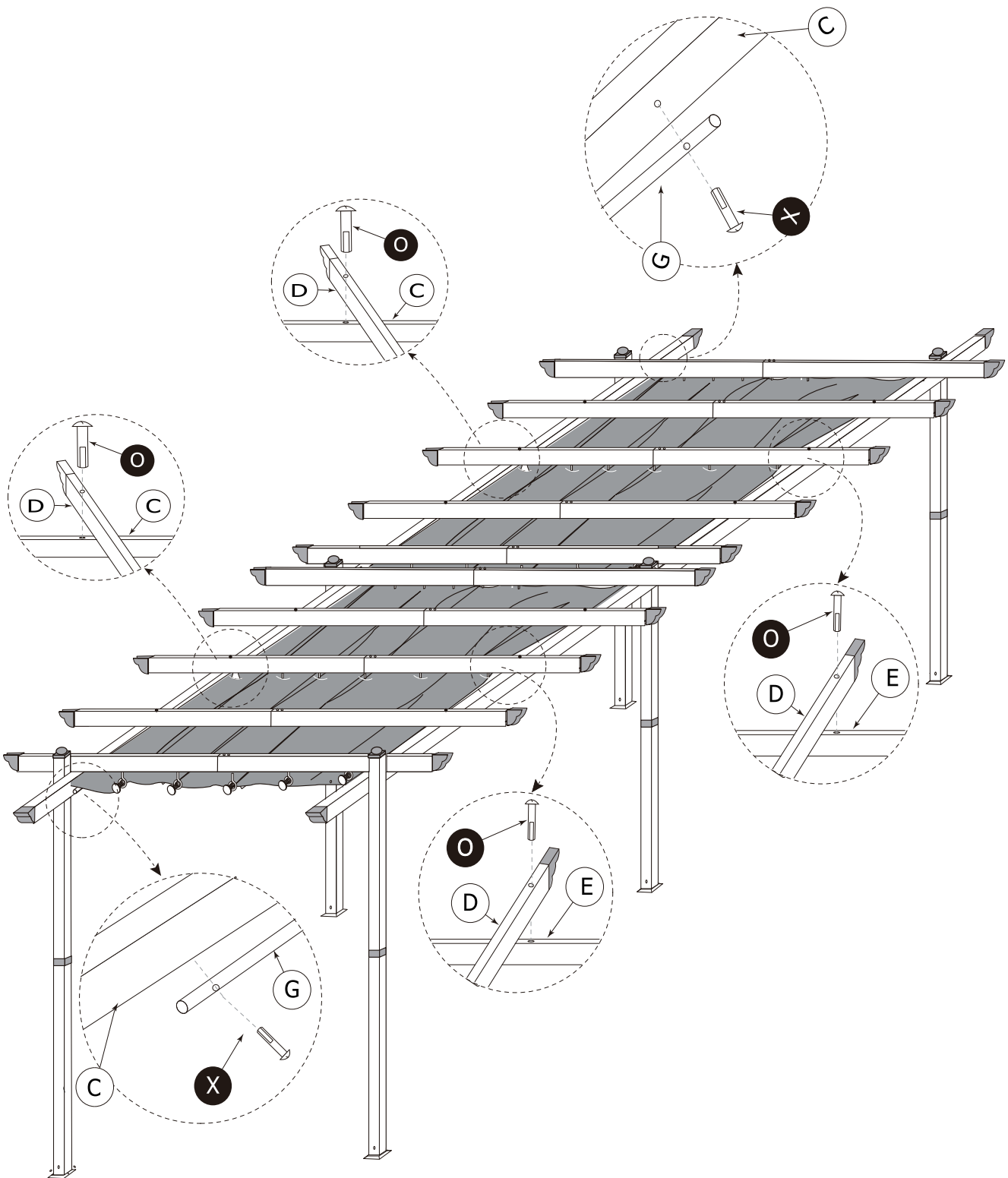

O x4

X x4

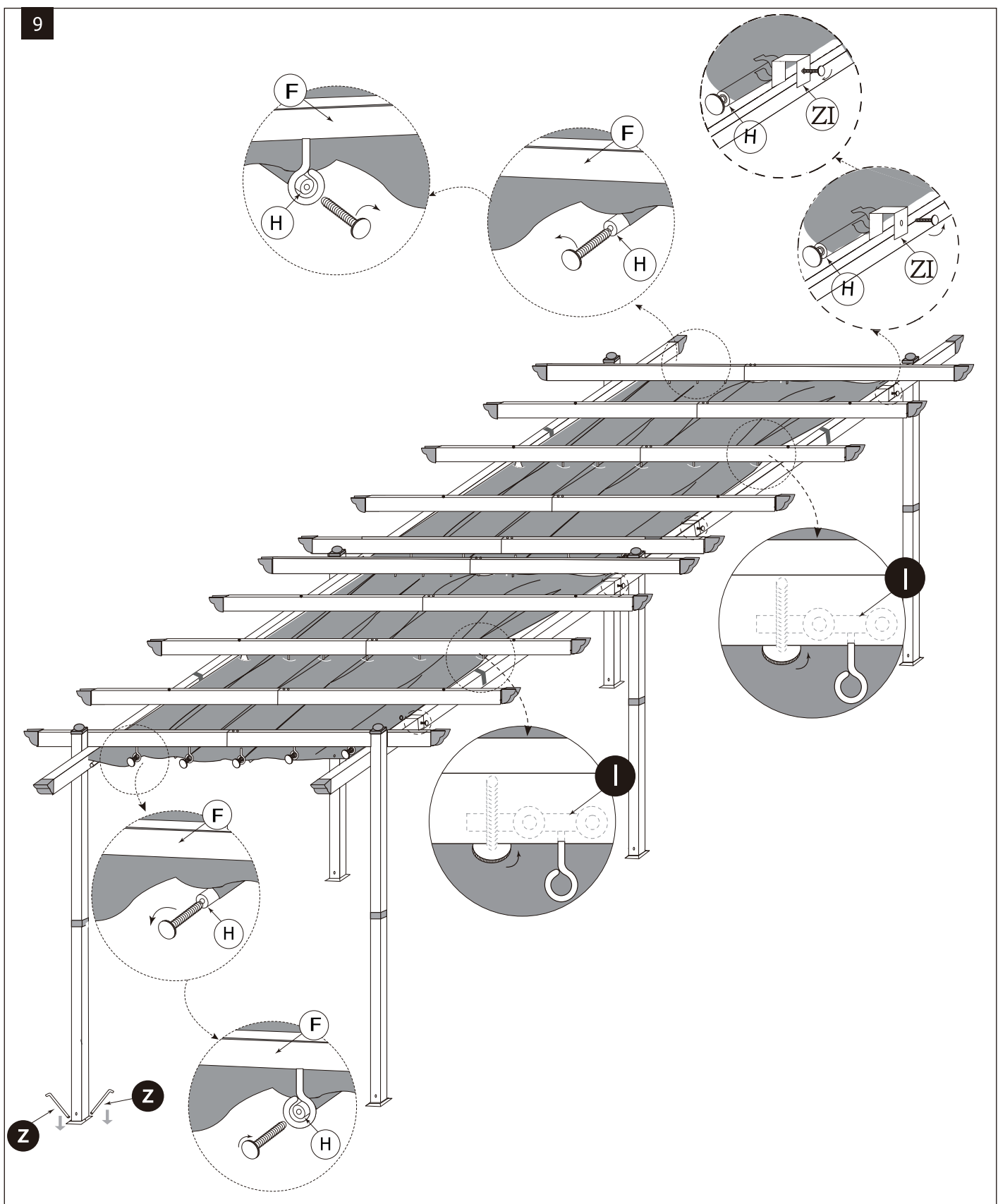

Z x12

Z1 x4