

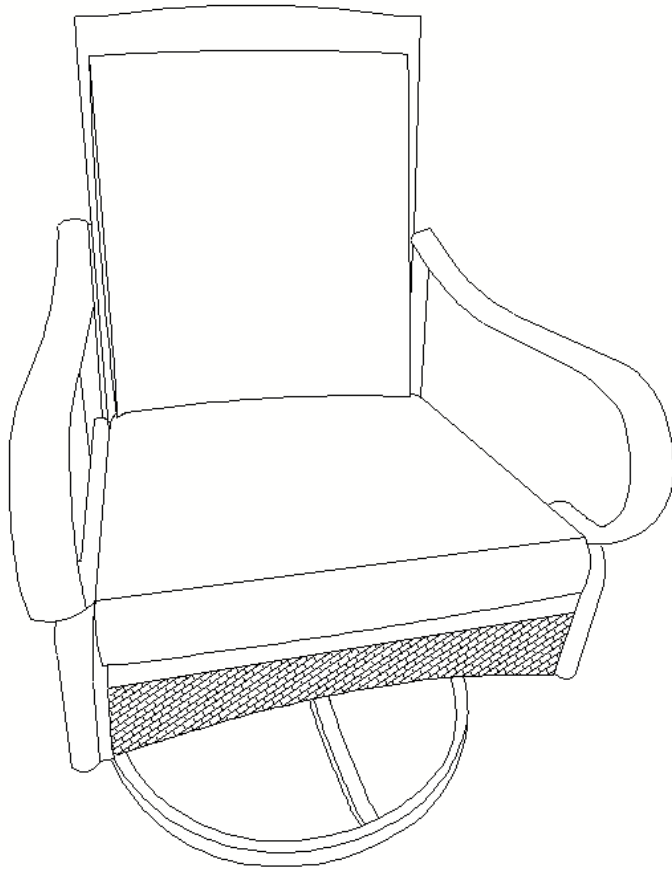

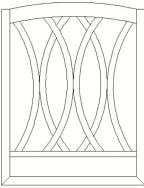

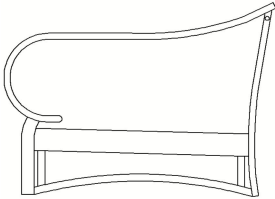

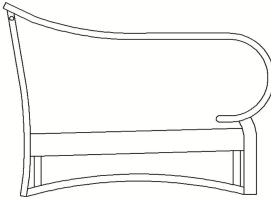

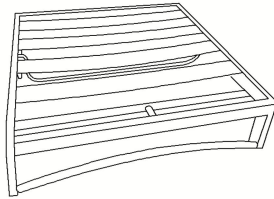
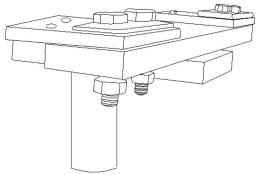
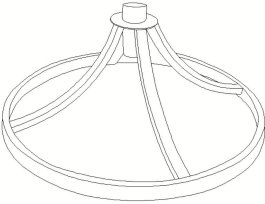
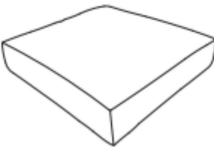
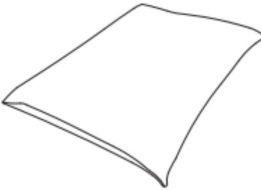
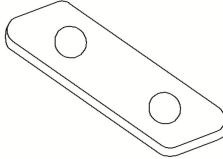

**G4045-DSR dining chair
(SKU#LYOT-035BU)**



PARTS LISTS

A 	B 	C 	D 	E 
1PC	1PC	1PC	1PC	1PC
F 	G 	H 	P 	
1PC	1PC	1PC	4PCS	

HARDWARE LISTS

#1  <p>M6*25mm bolt</p>	#2  <p>M6*30mm bolt</p>	#3  <p>M6*40mm bolt</p>	#4  <p>M6 washer</p>	#5  <p>SocketWrench</p>
2PCS	4PCS	2PCS	8PCS	1PCS
#6  <p>Wrench</p>	#7  <p>M8*33mm bolt</p>	#8  <p>M8 nut</p>	#9  <p>M8 washer</p>	
1PCS	4PCS	4PCS	8PCS	

Step1

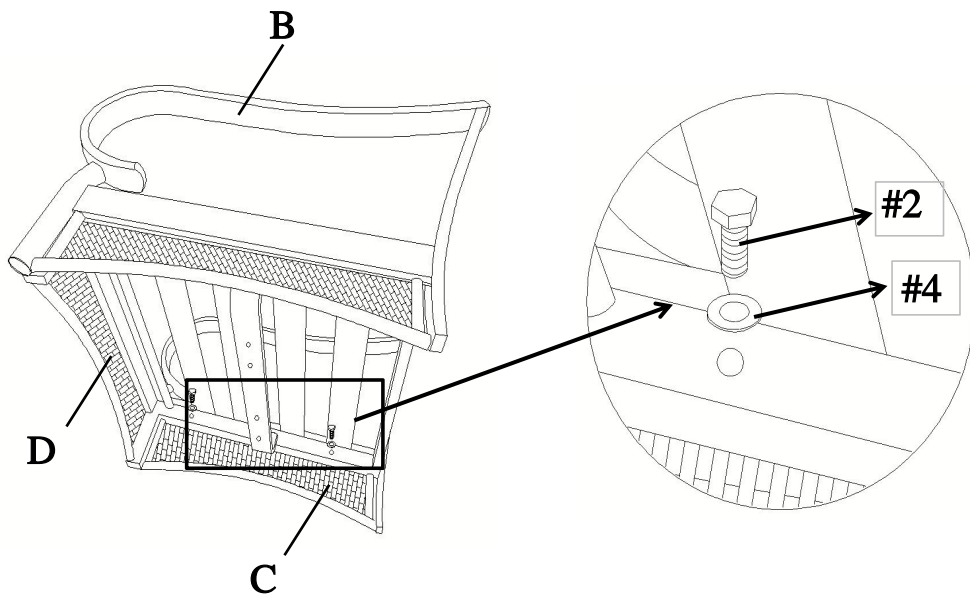

Step2

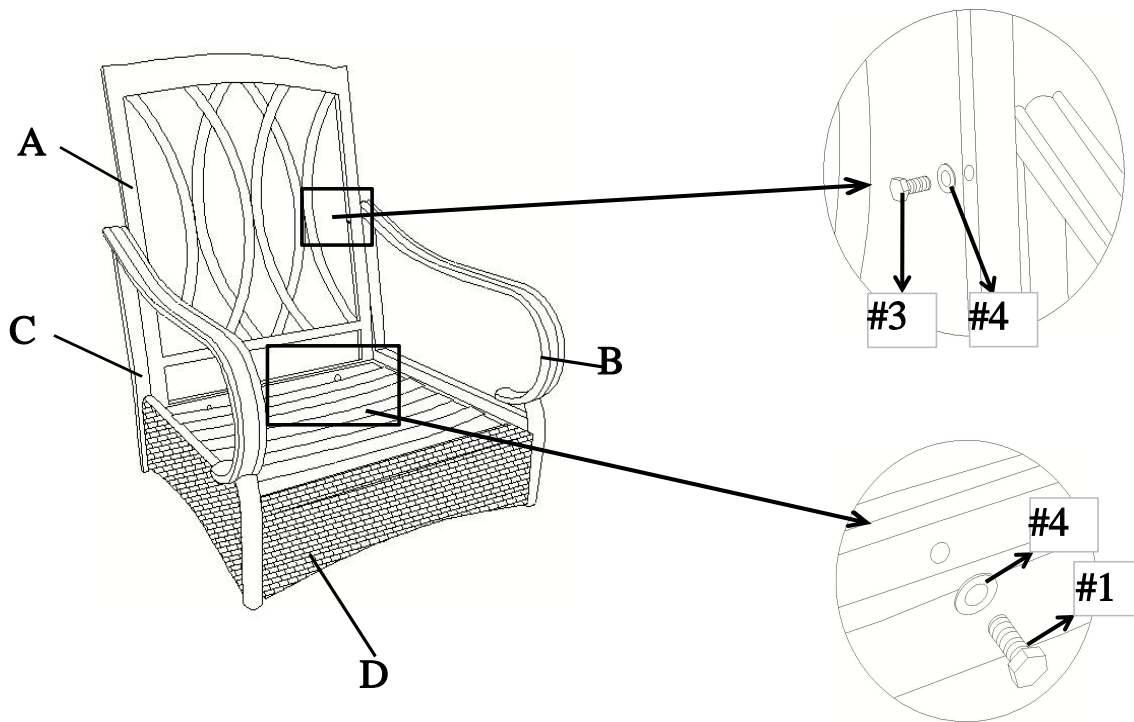

Step3

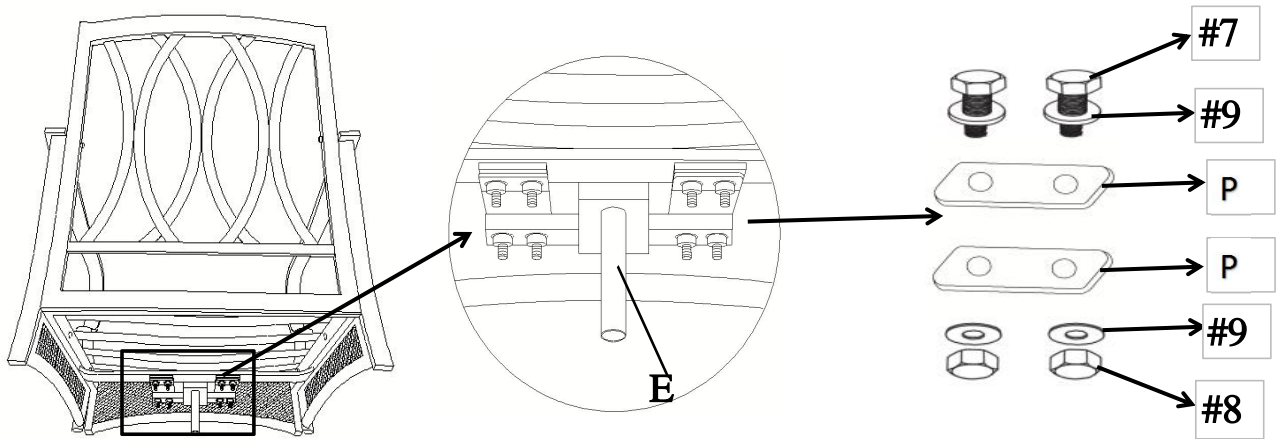

Step4

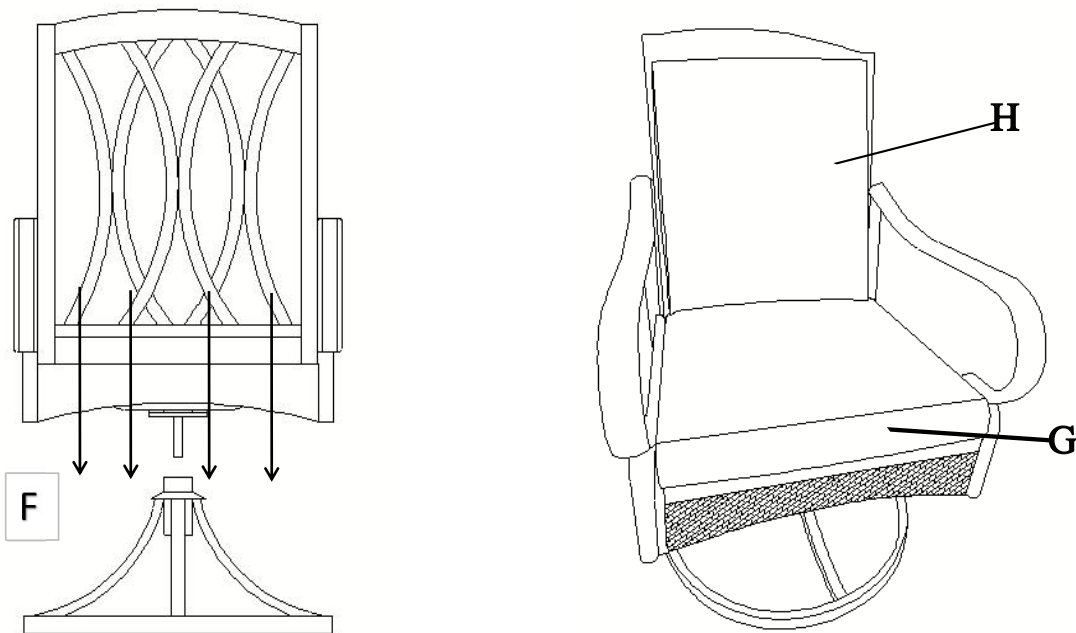

TIGHTEN ALL SCREWS AND INSERT THE SEAT INTO THE BASE