

Tin Shed  
BAAP002GY

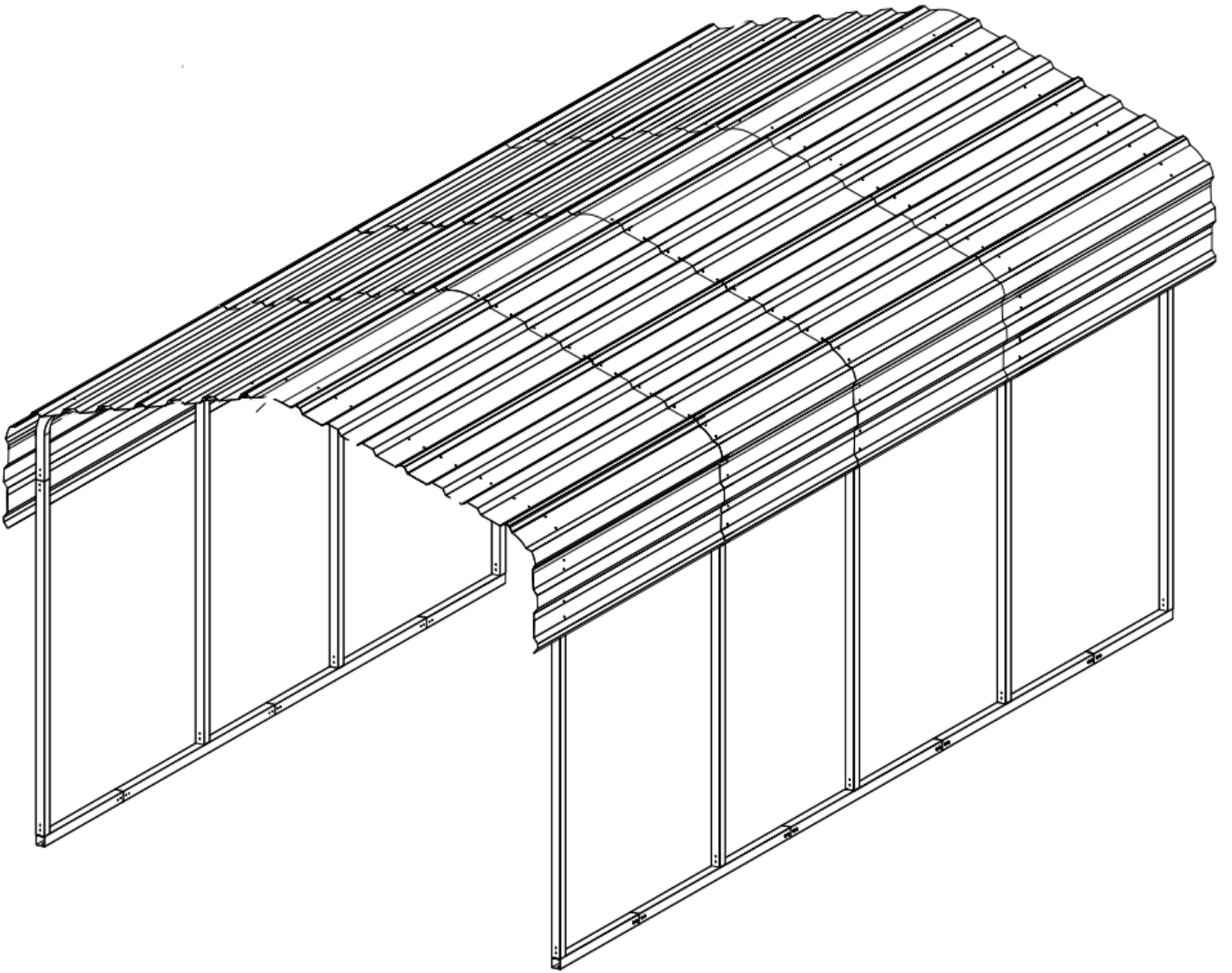

# 12X20 ACCESSORIES LIST

## A BOX

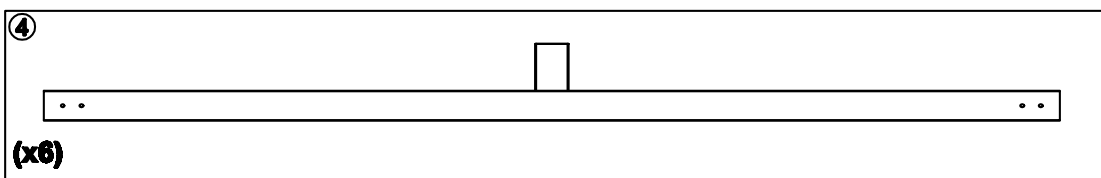
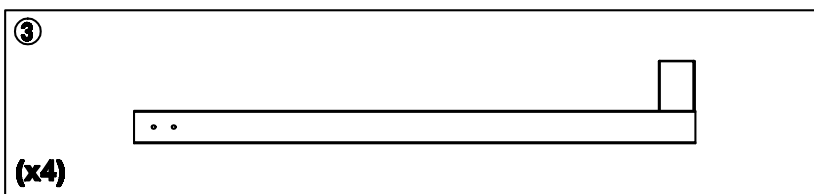
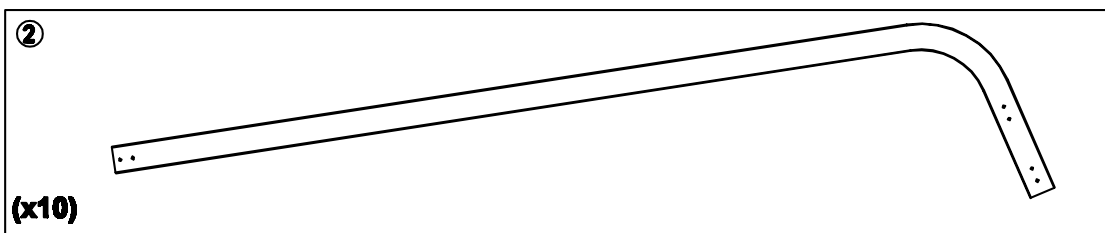
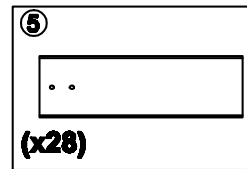
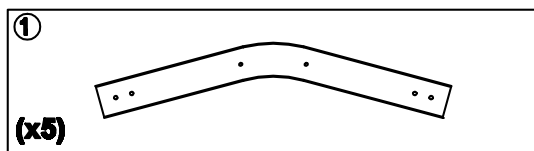
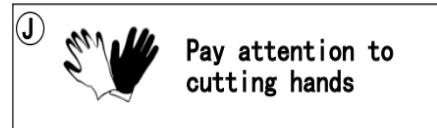
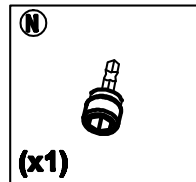
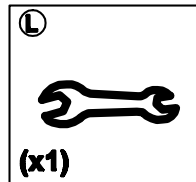
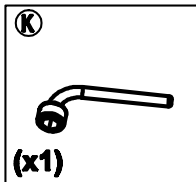
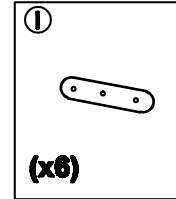
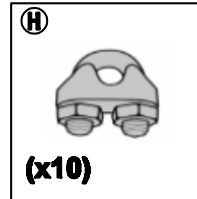
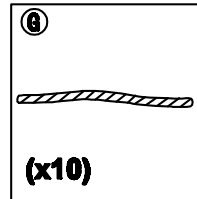
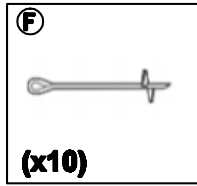
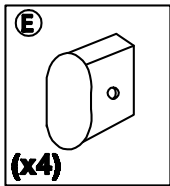
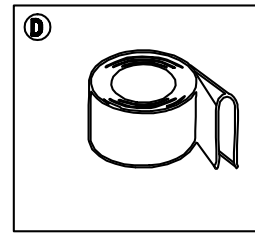
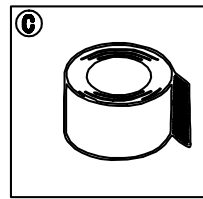
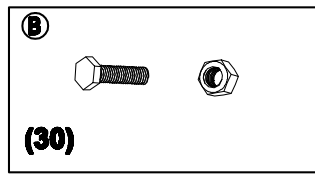
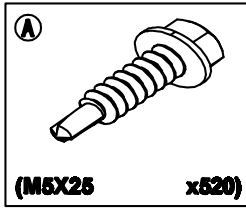

# 12X20 ACCESSORIES LIST

## B BOX

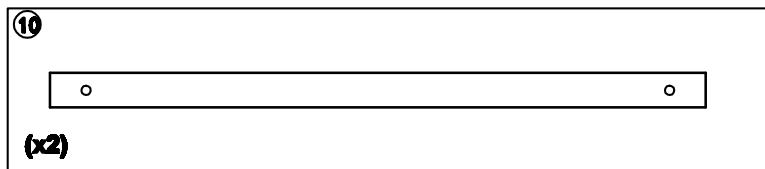
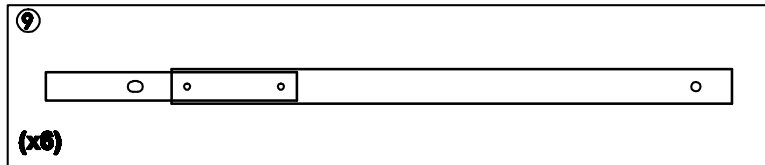
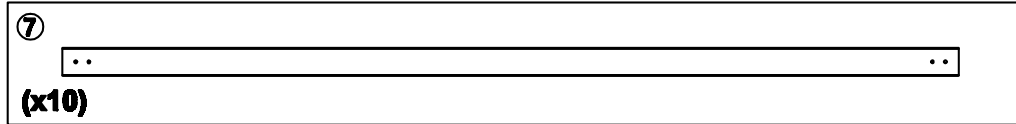
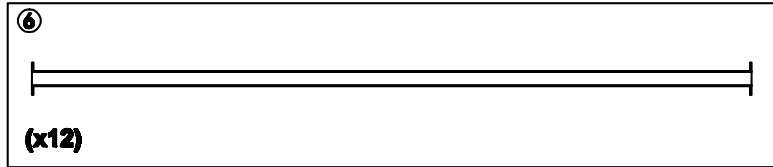

## C BOX

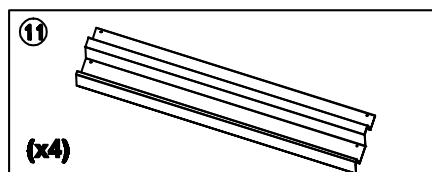
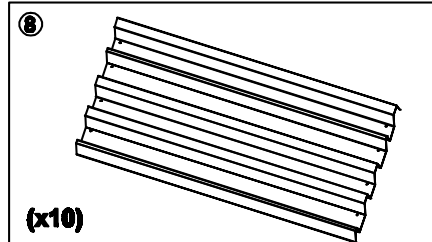

## D BOX

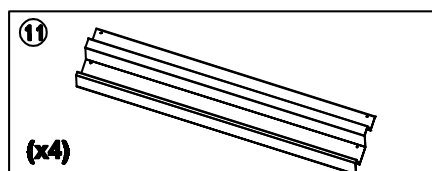
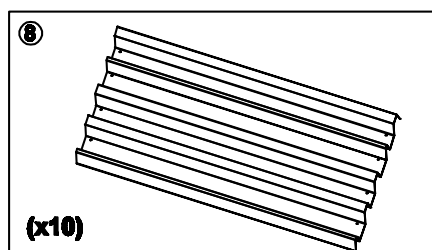

# Step 1

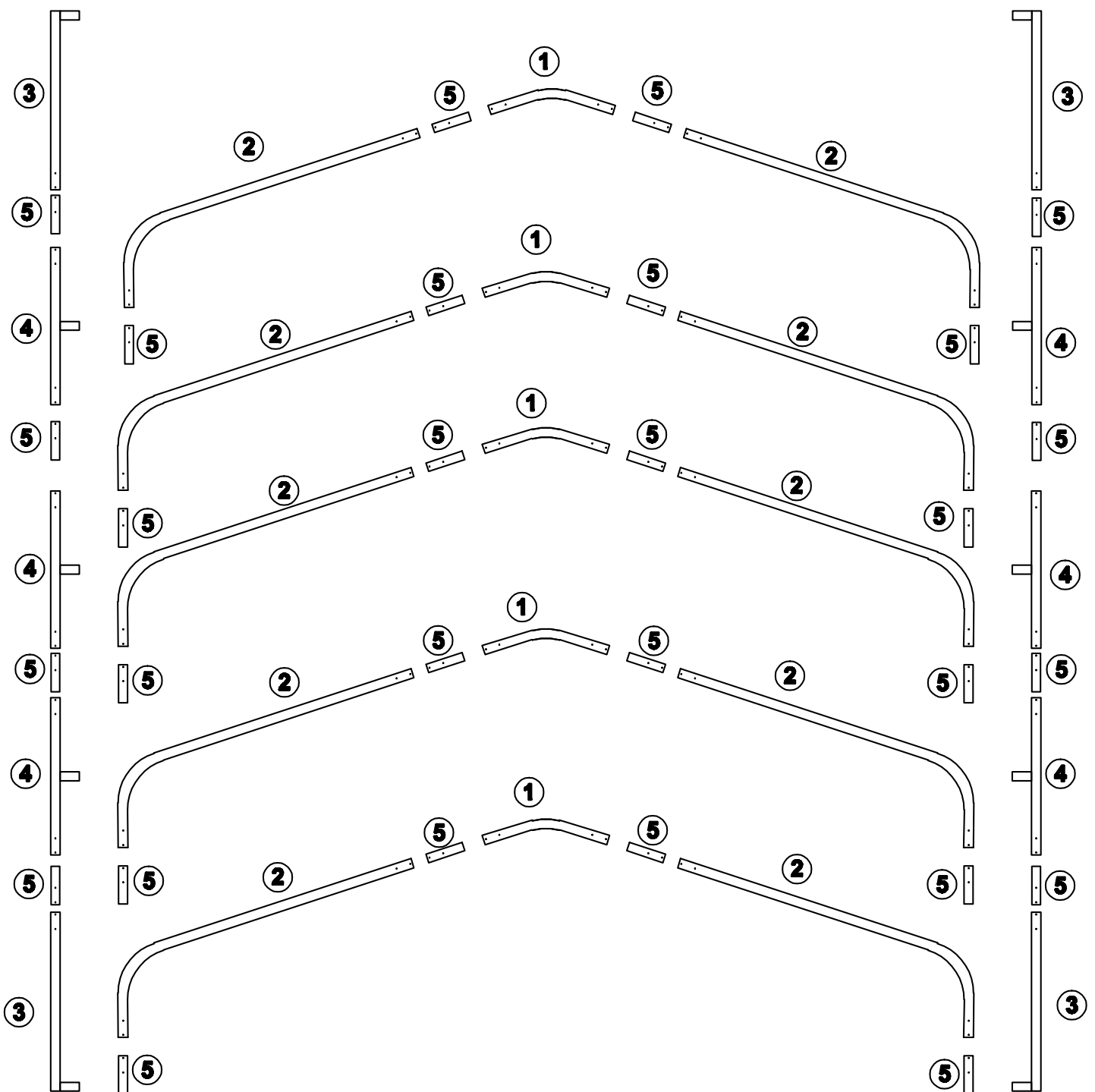
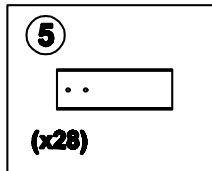
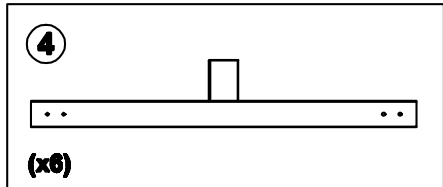
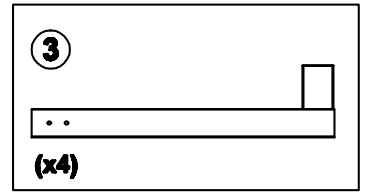
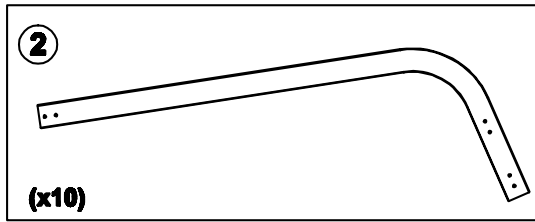
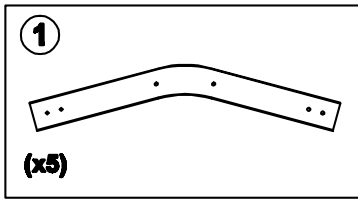

# Step 2

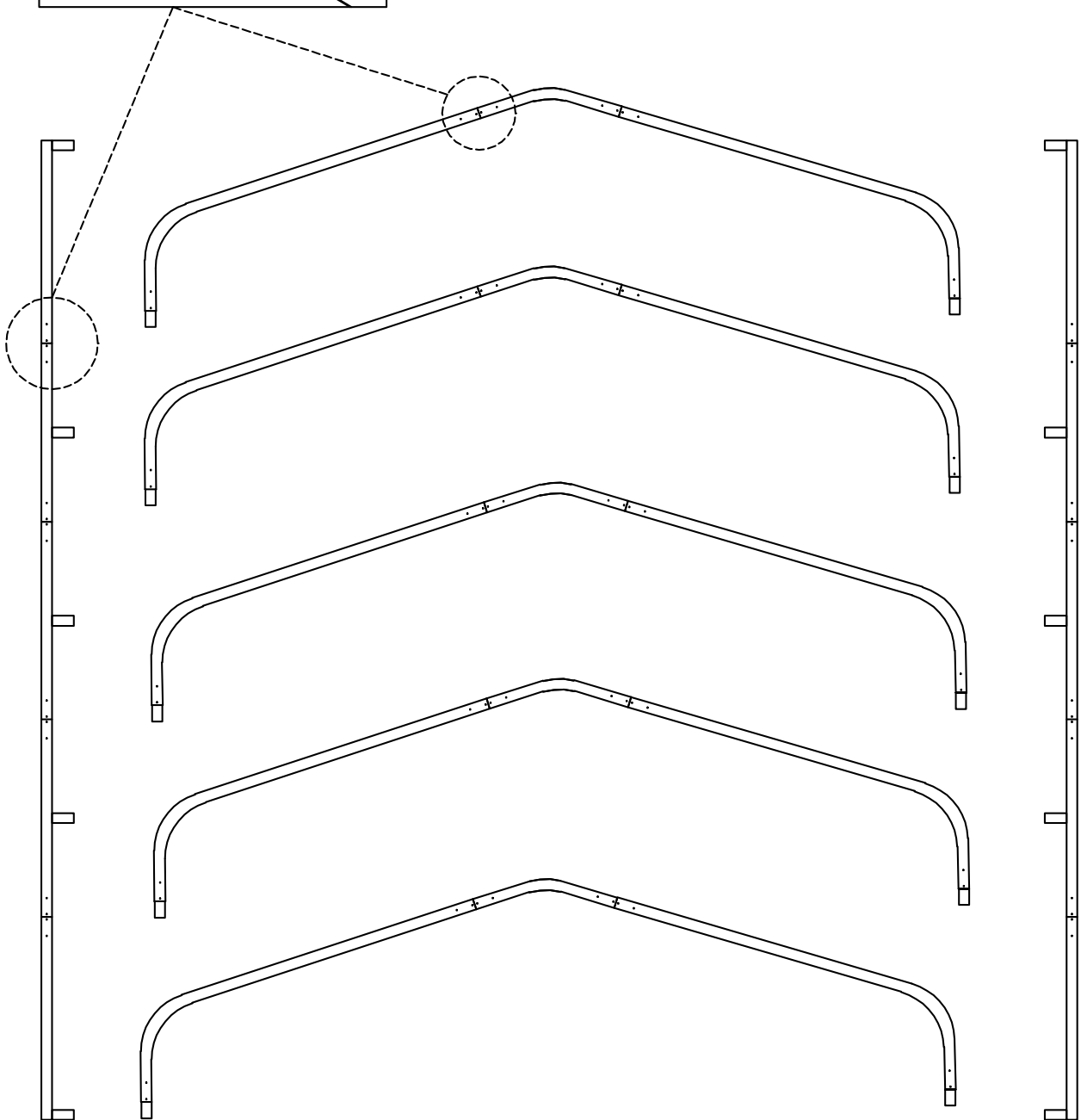
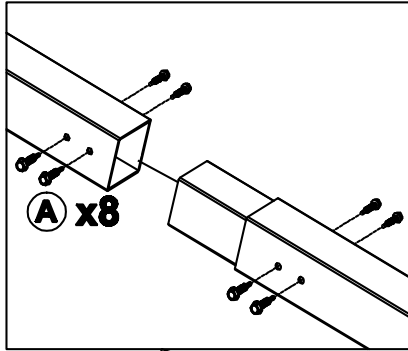
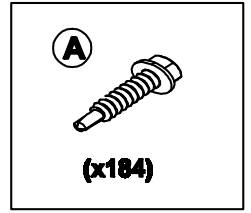

# Step 3

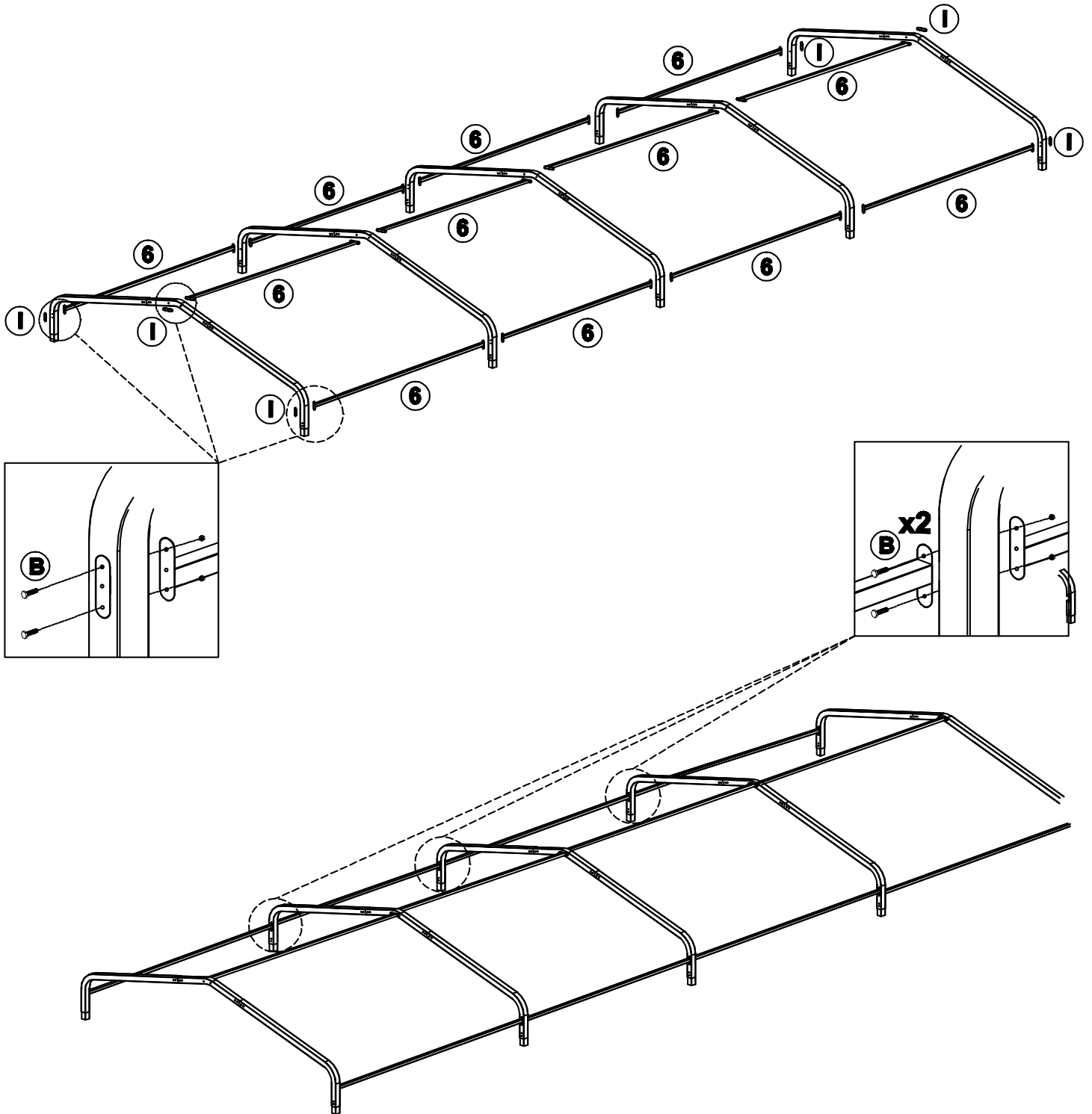
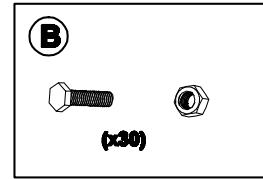
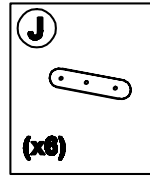
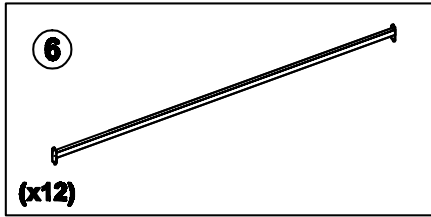

# Step 4

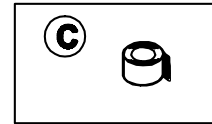
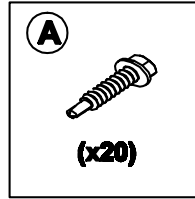
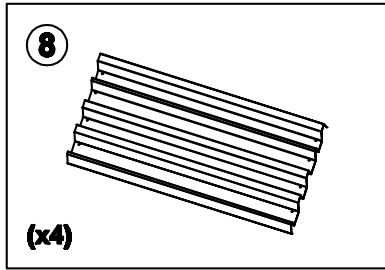

The waterproof strip is affixed to the iron pipe and do not cover the screw hole

Color steel tile 8cm

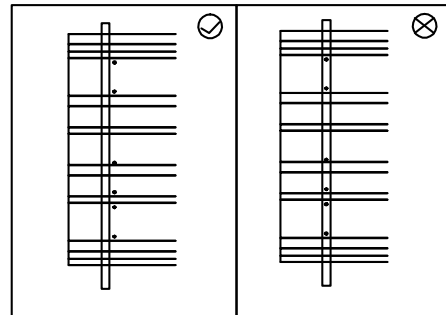
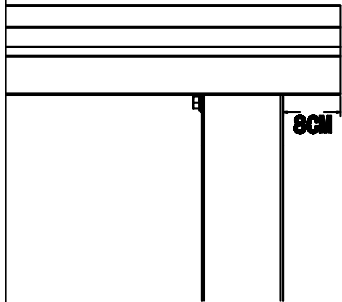

Color steel tile laying to a direction , then and drainage

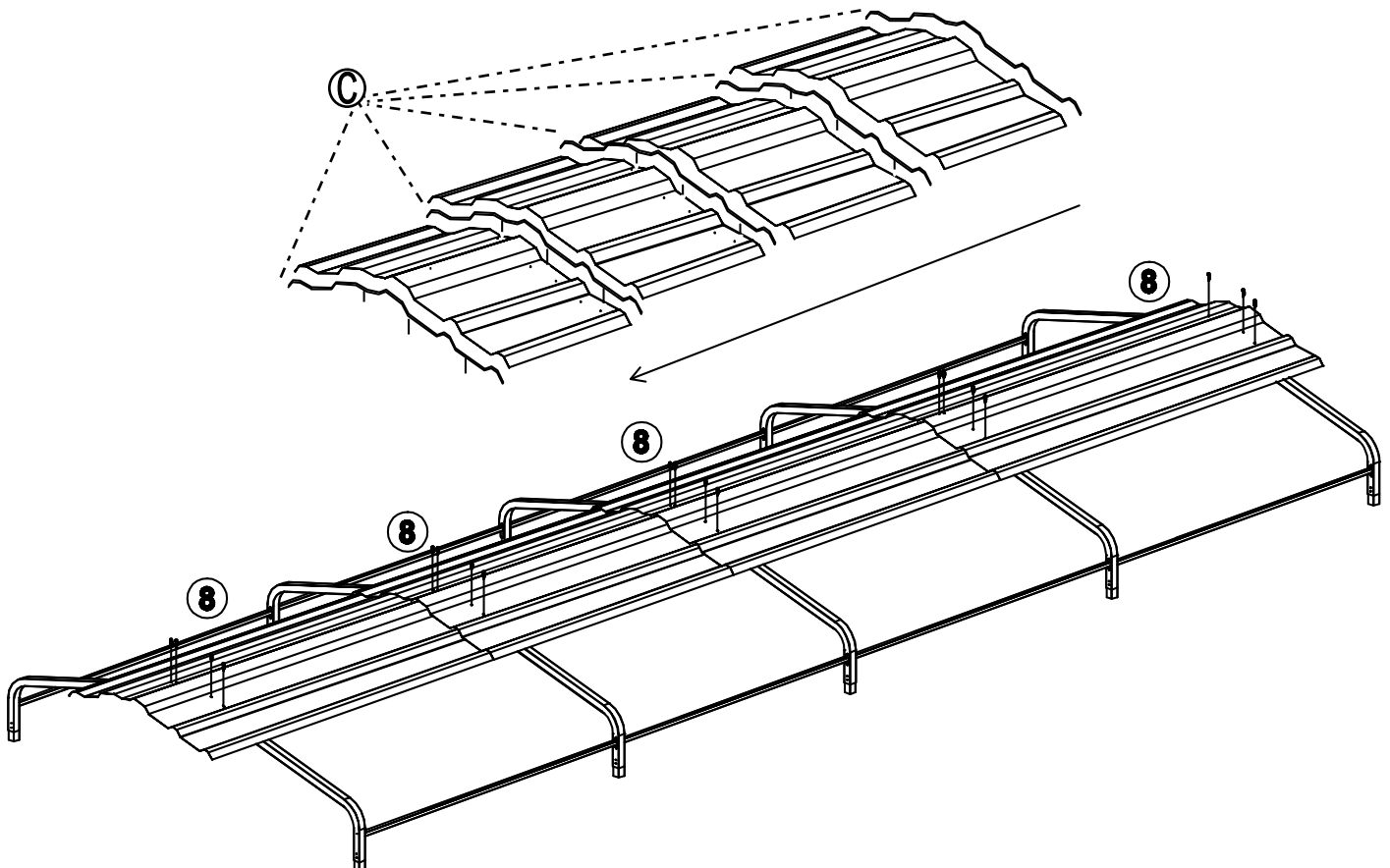

# Step 5

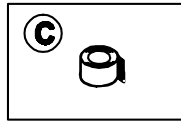
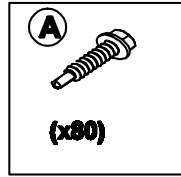
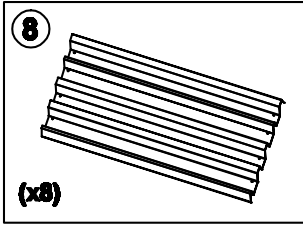

The waterproof strip is affixed to the iron pipe and do not cover the screw hole

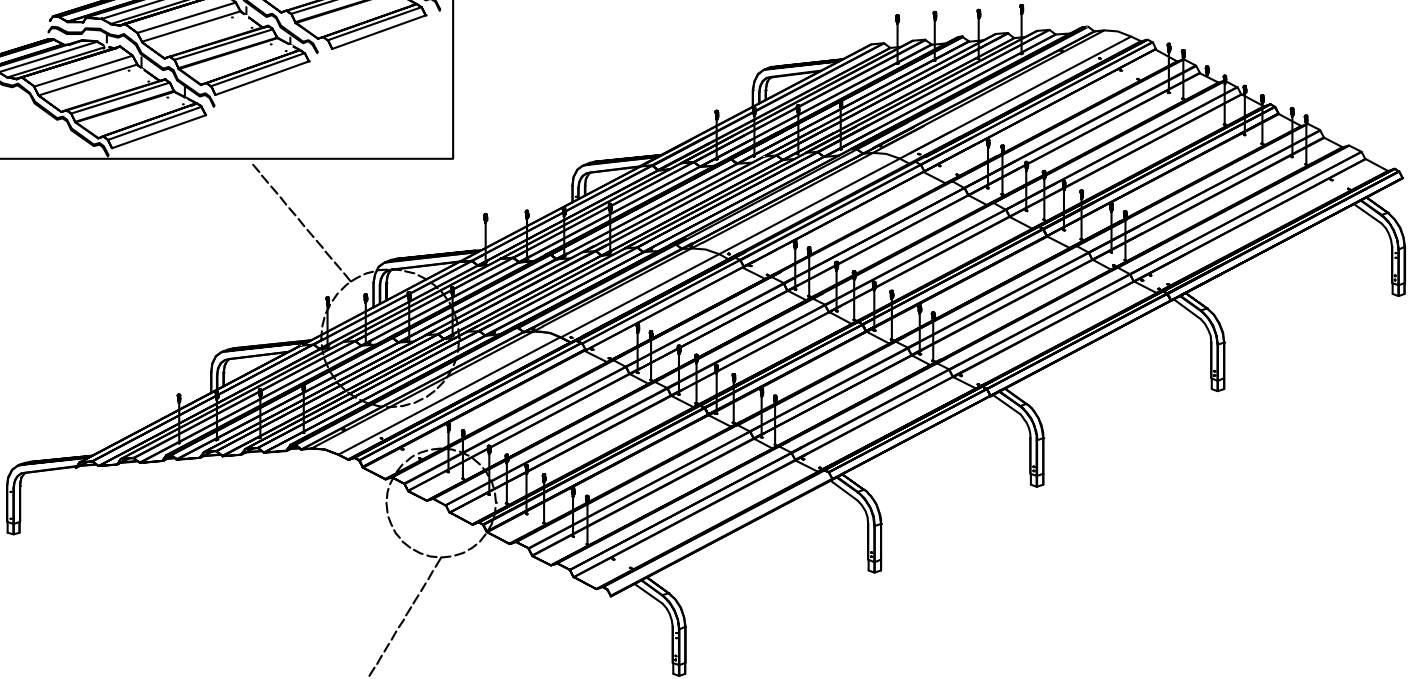
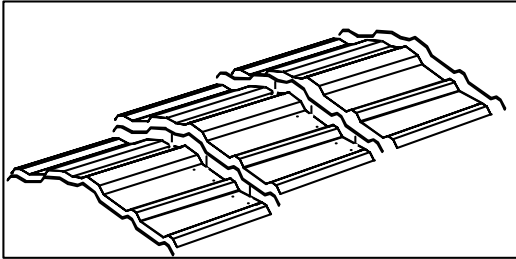
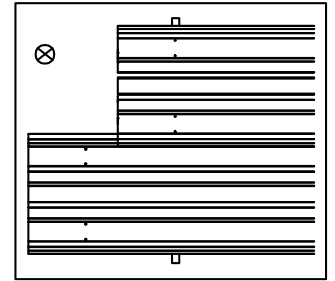
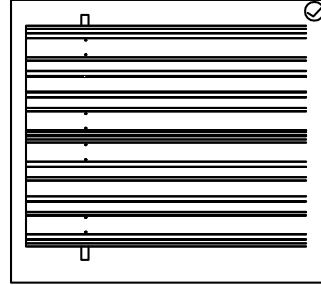

Color steel tile connection should pay attention to the above a piece of pressure below a piece, to prevent water

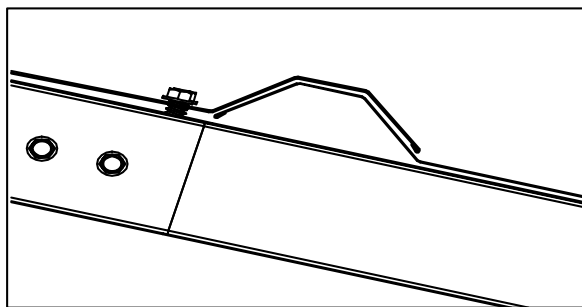
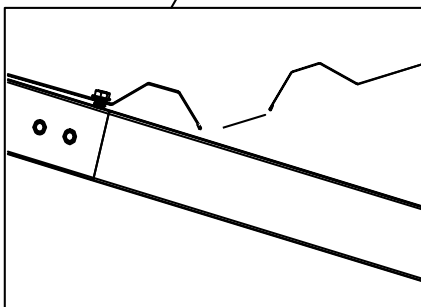



# Step 6

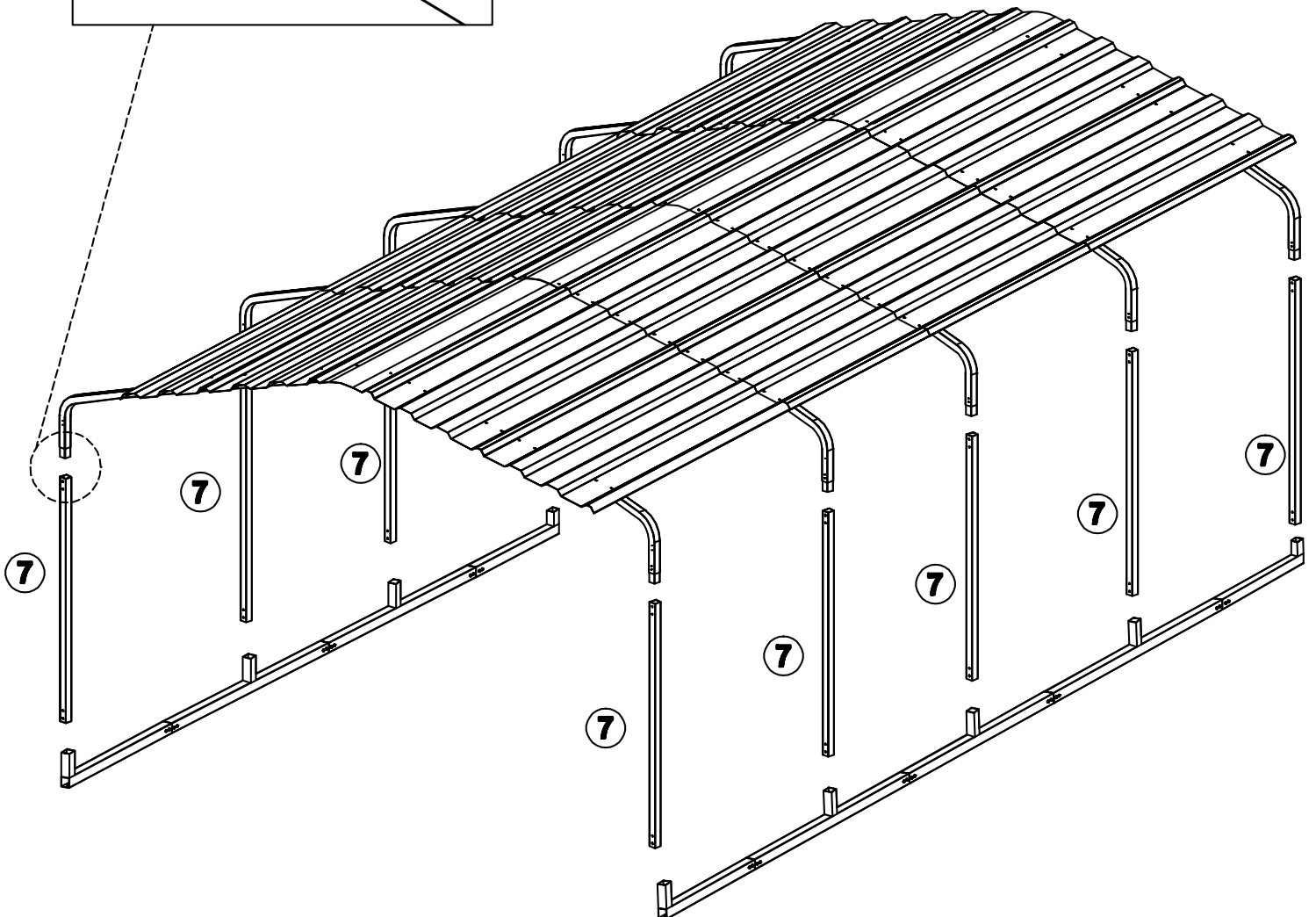
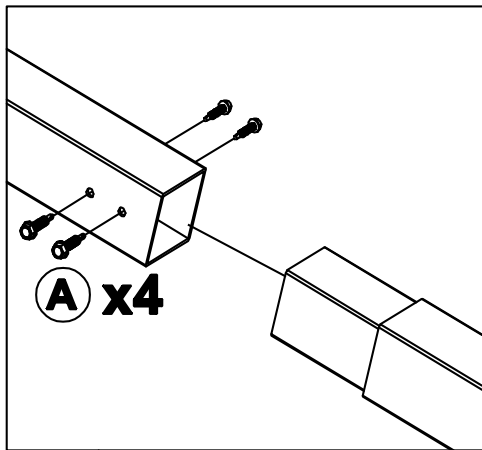
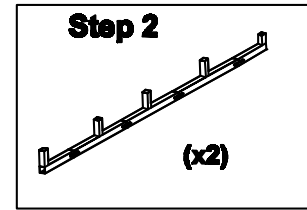
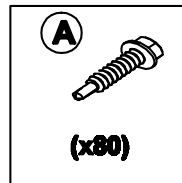
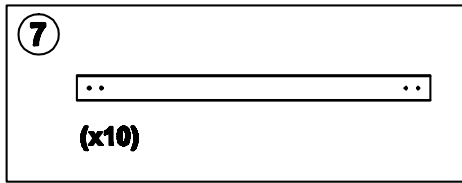

# Step 7

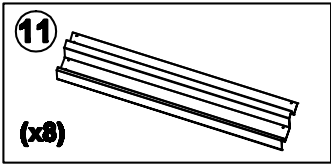
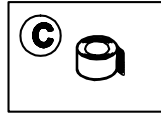
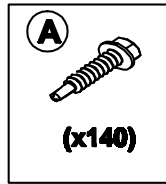
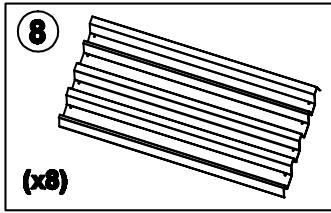

The waterproof strip is affixed to the iron pipe and do not cover the screw hole

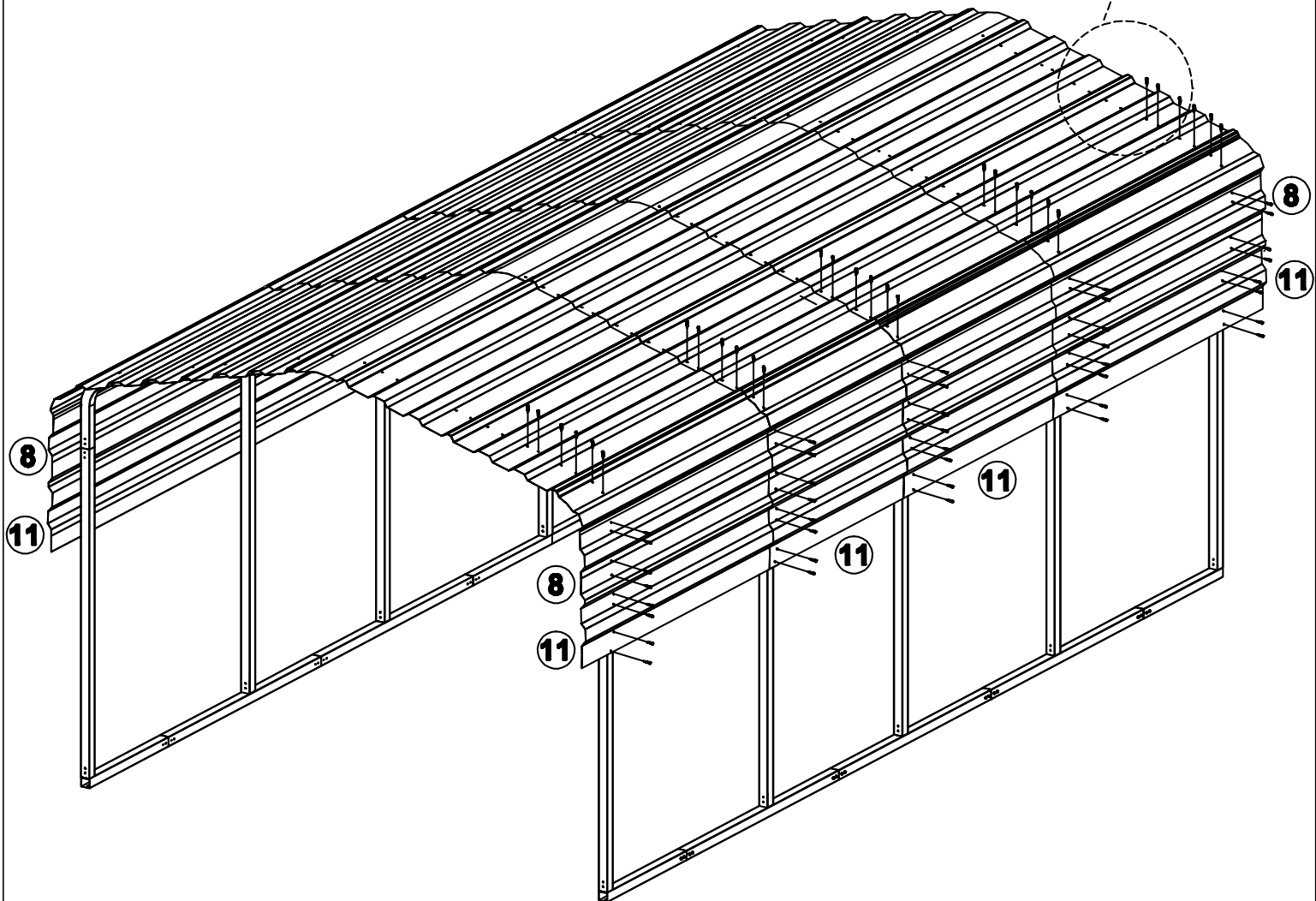
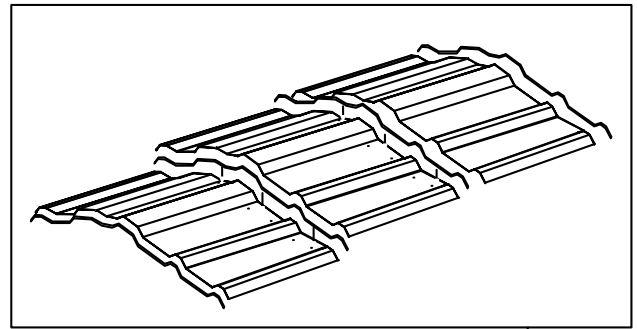

# Step 8

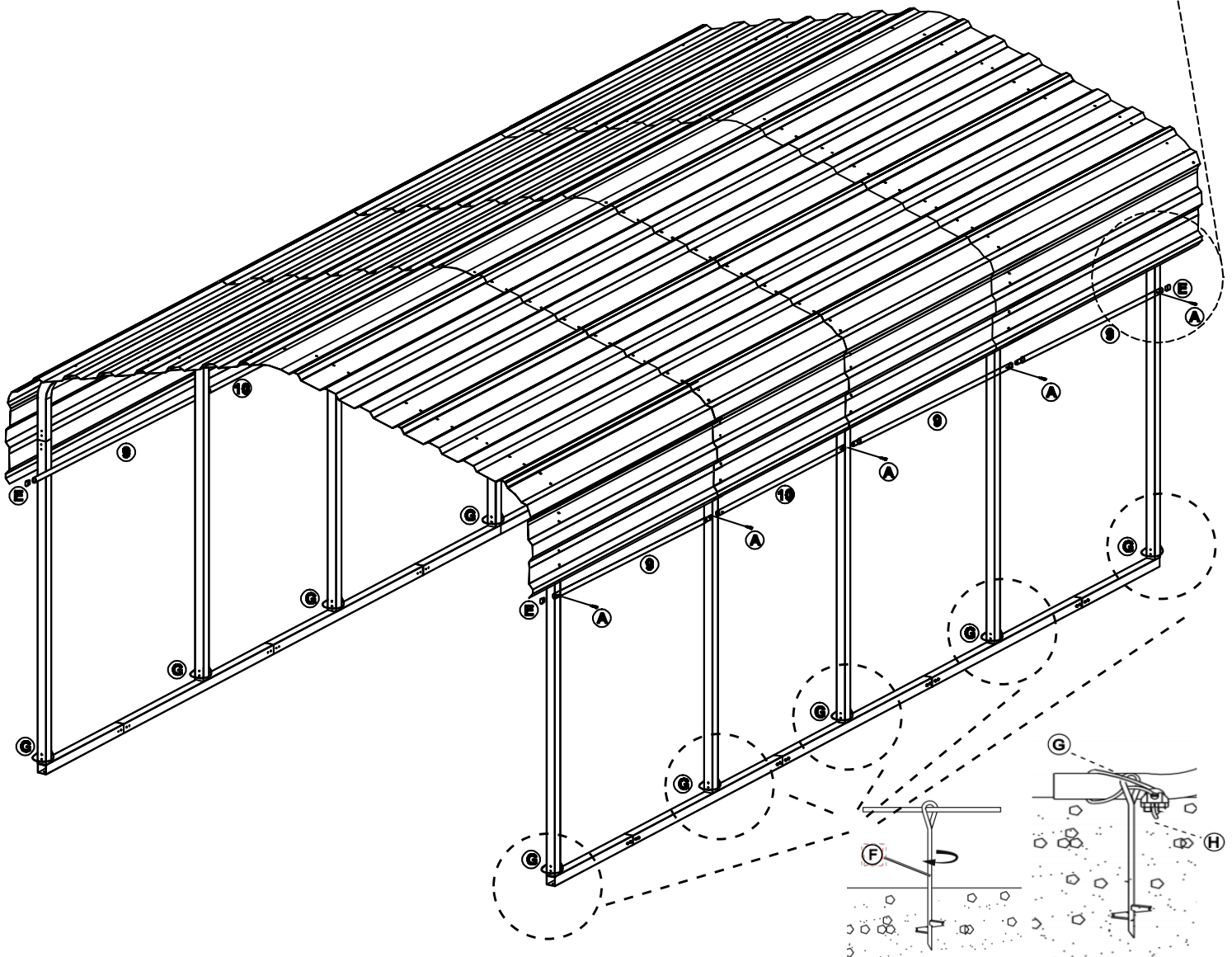
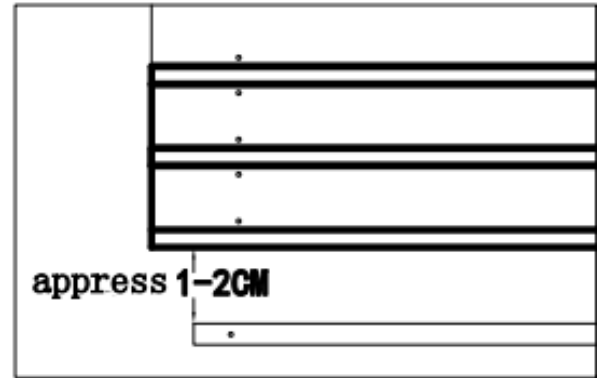
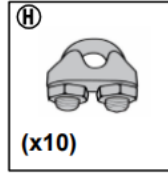
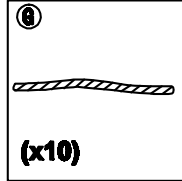
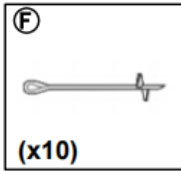
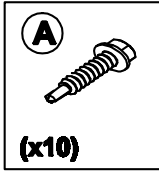
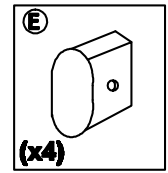
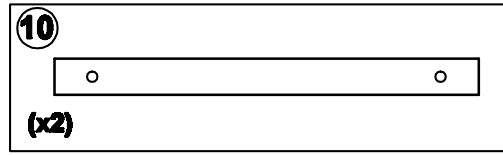
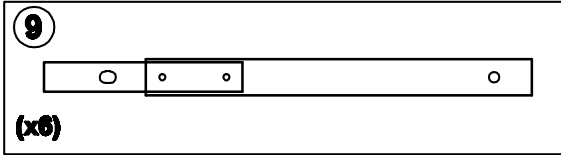

# Step 9

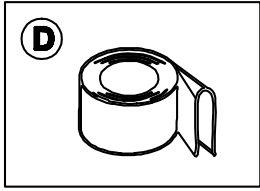

To extend the package of the color steel tile pointed Angle, to prevent injuries.

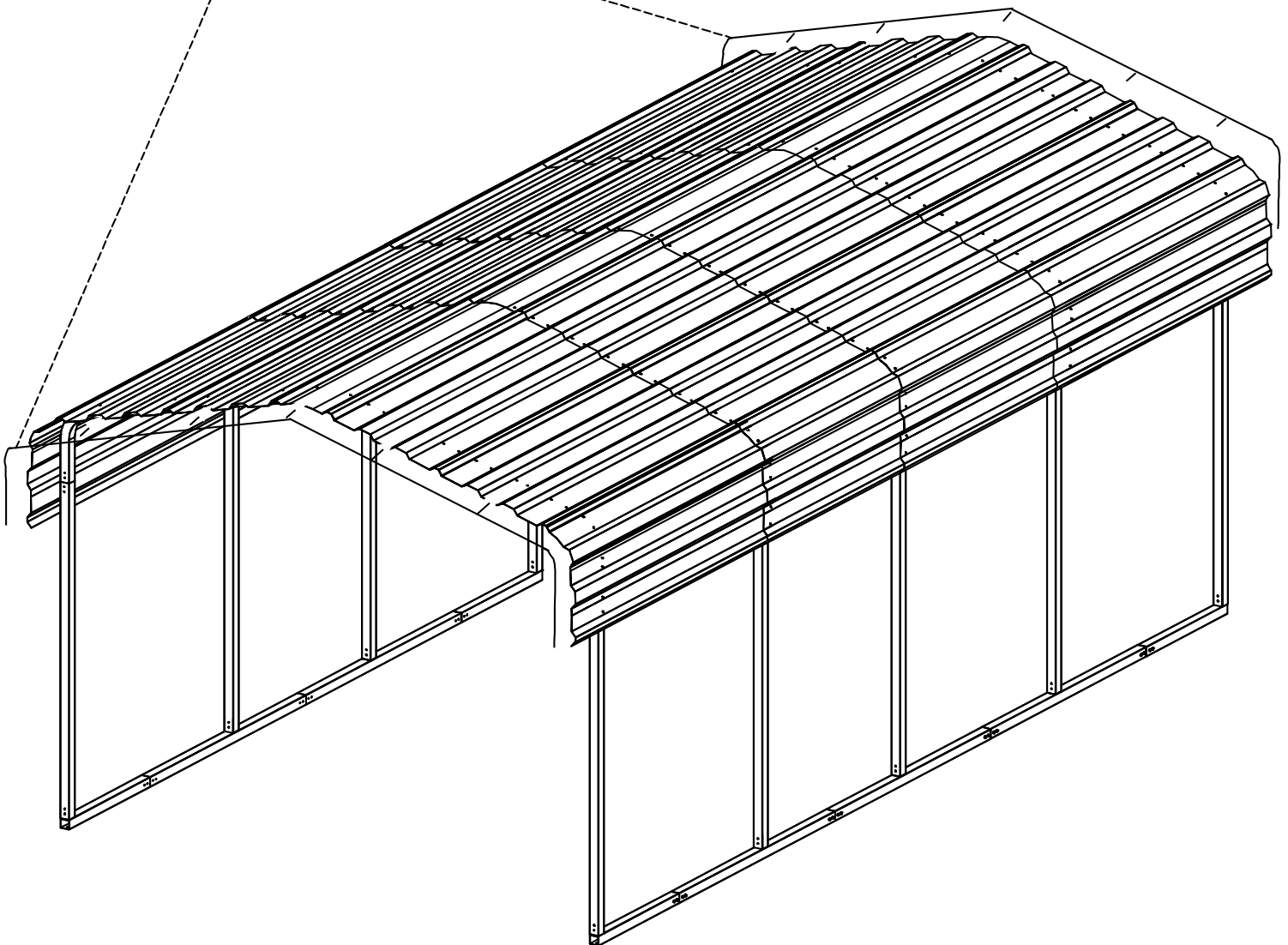
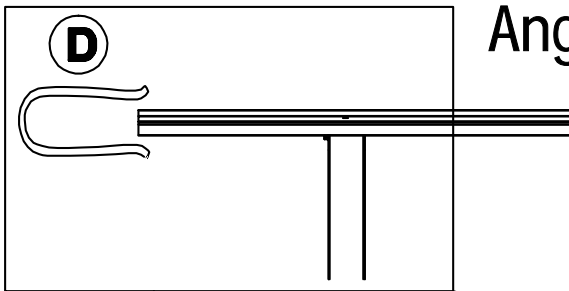



The extra part of the model A screw is used for the situation shown in the circle above, and the customer decides whether to install it, if installed, as shown in the circle below.

