

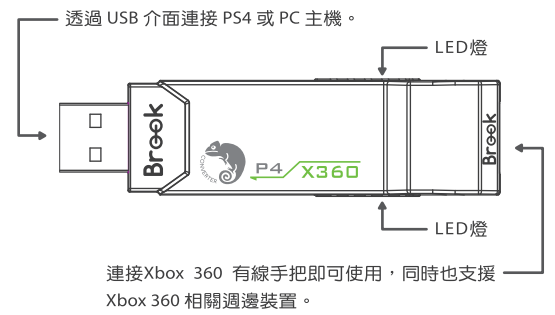

# Game Controller Super Converters

Magic stick P4-GN

## Xbox 360 ↔ PS4 Controller Adapter



**step.1**  
將 Game Controller Super Converters 連接到 PS4 主機的 USB 連接埠。等待 LED 藍燈亮起即代表與主機連線成功。

**step.2**  
Xbox 360 手柄透過 USB 線與 Game Controller Super Converters 連接後，待手柄 Player 指示燈亮起（或確認手柄能用有線操控的方式對應主機功能），即表示與 Game Controller Super Converters 註冊完成。

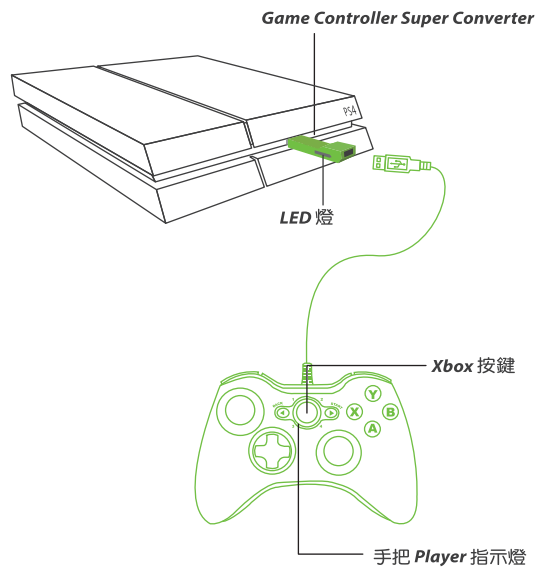

· 每個 Super Converter 一次僅能對應一支 Xbox 360 手柄進行控制。

可自動判斷 Xbox 360 手柄與方向盤功能，不需要(機動開關)設定，自動對應 PS4 按鍵功能。

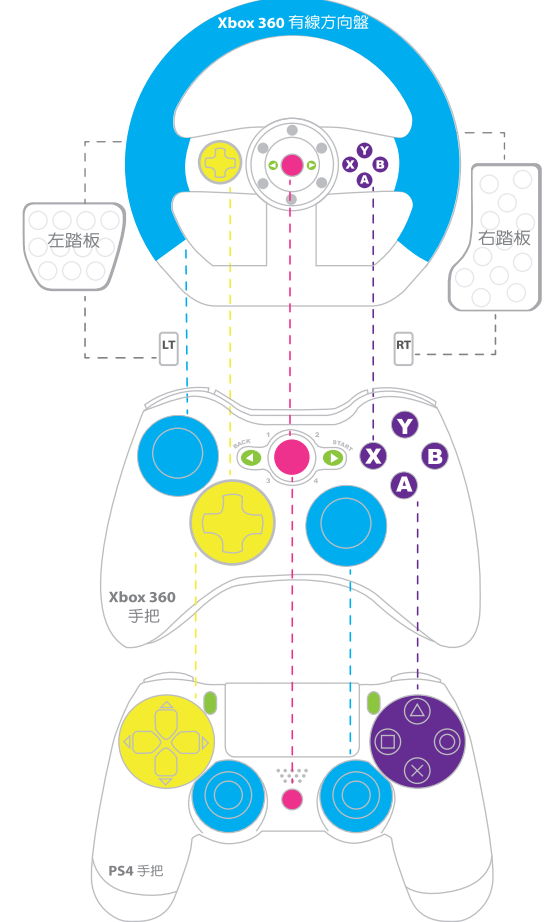

PS4 手柄	Xbox 360 手柄	Xbox 360 方向盤	Xbox 360 大搖桿
DPad-UP	DPad-UP	DPad-UP	DPad-UP
Dpad-Down	Dpad-Down	Dpad-Down	Dpad-Down
Dpad-Left	Dpad-Left	Dpad-Left	Dpad-Left
Dpad-Right	Dpad-Right	Dpad-Right	Dpad-Right
X	A	A	A
O	B	B	B
□	X	X	X
△	Y	Y	Y
OPTIONS	Start	Start	Start
SHARE	Back	Back	Back
Lx	Lx	Lx	--
Ly	Ly	--	--
Rx	Rx	--	--
Ry	Ry	--	--
L1	LB	LB	LB
R1	RB	RB	RB
L2	LT	LT	LT
R2	RT	RT	RT
L3	L3	--	--
R3	R3	--	--
PS Key	Xbox Key	Xbox Key	Xbox Key
Touchpad Key	L3+ R3	--	--

### Turbo 使用設定步驟:

**step.1**  
將手柄按住 Xbox 鍵 + BACK 鍵，轉接器的 LED 藍燈轉成 LED 紅燈進入設定模式。



**step.2**  
按住 BACK 鍵不放，再選擇想要連發的按鍵，可選擇一個或是多個按鍵。



**step.3**  
按下 START 鍵後，設置完畢。



**step.4**  
按下 Xbox 鍵，轉接器中的 LED 紅燈轉換成 LED 藍燈代表退出設定模式。



### 清除全部 Turbo 使用設定步驟:

**step.1**  
將手柄按住 Xbox 鍵 + BACK 鍵，轉接器的 LED 藍燈轉成 LED 紅燈，進入設定模式。



**step.2**  
再同時按下 BACK 鍵 + START 鍵，即可將設定全部清除。



**step.3**  
按下 Xbox 鍵，轉接器中的 LED 紅燈轉換成 LED 藍燈，代表退出設定模式。



更多詳細操作請上官網查詢 [www.brookaccessory.com](http://www.brookaccessory.com)

### Remap Key/Custom Buttons 使用設定步驟:

**step.1**  
將手柄按住 Xbox 鍵 + START 鍵，轉接器的 LED 藍燈轉成 LED 紅燈，即進入設定模式。



**step.2**  
轉移單一按鍵功能 (比如將 B 鍵變成 A 鍵使用)



**step.3**  
按下 Xbox 鍵，轉接器中的 LED 紅燈轉換成 LED 藍燈，代表退出設定模式。



單一按鍵功能轉移到復數鍵使用 (比如將 B 按鍵變成 X+B+A 三鍵使用)



**step.3**  
按下 Xbox 鍵，轉接器中的 LED 紅燈轉換成 LED 藍燈，代表退出設定模式。



### 清除全部 Remap Key/Custom Buttons 使用設定步驟:

**step.1**  
將手柄按住 Xbox 鍵 + START 鍵，轉接器的 LED 藍燈轉成 LED 紅燈，進入設定模式。



**step.2**  
再同時按下 BACK 鍵 + START 鍵，即可將設定全部清除。



**step.3**  
按下 Xbox 鍵，轉接器中的 LED 紅燈轉換成 LED 藍燈，代表退出設定模式。



更多詳細操作請上官網查詢 [www.brookaccessory.com](http://www.brookaccessory.com)



# Game Controller Super Converters

Magic stick P4-GN

## Xbox 360 ↔ PS4 Controller Adapter

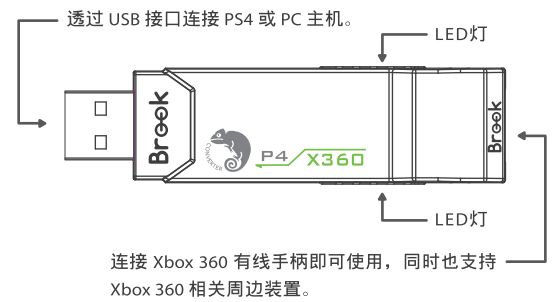

**step.1**  
將 Game Controller Super Converters 連接到 PS4 主機的 USB 連接埠，等待 LED 藍燈亮起即代表與主機連線成功。

**step.2**  
Xbox 360 手柄透過 USB 線與 Game Controller Super Converters 連接後，待手柄 Player 指示燈亮起（或確認手柄能用有線操控的方式對應主機功能），即表示與 Game Controller Super Converters 註冊完成。

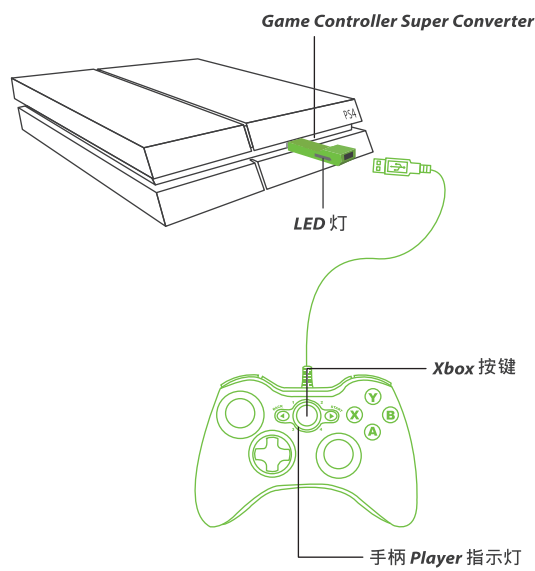

· 每個 Super Converter 一次僅能對應一支 Xbox 360 手柄進行控制。

可自動判斷 Xbox 360 手柄與方向盤功能，不需要(機動開關)設定，自動對應 PS4 按鍵功能。

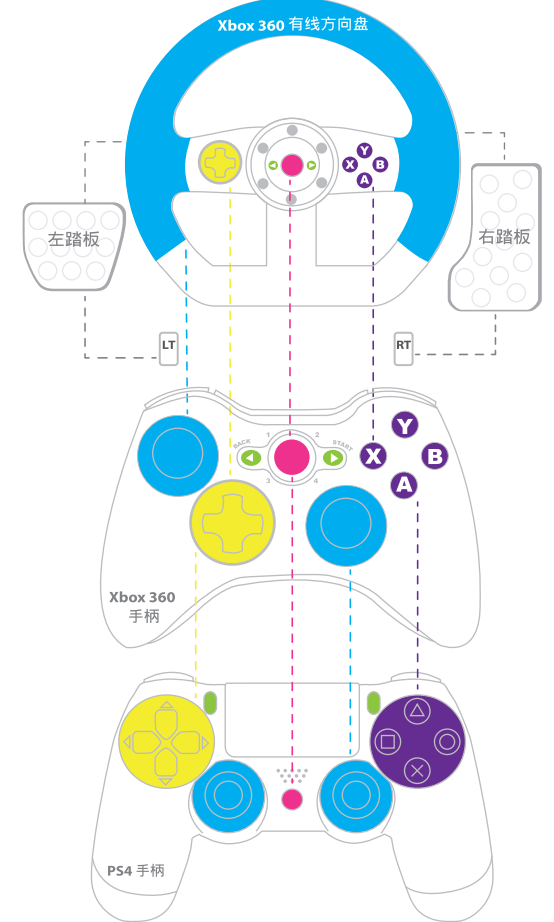

PS4 手柄	Xbox 360 手柄	Xbox 360 方向盤	Xbox 360 大搖台
DPad-UP	DPad-UP	DPad-UP	DPad-UP
Dpad-Down	Dpad-Down	Dpad-Down	Dpad-Down
Dpad-Left	Dpad-Left	Dpad-Left	Dpad-Left
Dpad-Right	Dpad-Right	Dpad-Right	Dpad-Right
X	A	A	A
O	B	B	B
□	X	X	X
△	Y	Y	Y
OPTIONS	Start	Start	Start
SHARE	Back	Back	Back
Lx	Lx	Lx	--
Ly	Ly	--	--
Rx	Rx	--	--
Ry	Ry	--	--
L1	LB	LB	LB
R1	RB	RB	RB
L2	LT	LT	LT
R2	RT	RT	RT
L3	L3	--	--
R3	R3	--	--
PS Key	Xbox Key	Xbox Key	Xbox Key
Touchpad Key	L3+ R3	--	--

### Turbo 使用設定步驟:

**step.1**  
將手柄按住 Xbox 鍵 + BACK 鍵，轉接器的 LED 藍燈轉成 LED 紅燈，即進入設定模式



**step.2**  
按住 BACK 鍵不放，再選擇想要連發的按鍵，可選擇一個或是多個按鍵。



**step.3**  
按下 START 鍵後，設置完畢。



**step.4**  
按下 Xbox 鍵，轉接器中的 LED 紅燈轉換成 LED 藍燈，代表退出設定模式。



### 清除全部 Turbo 使用設定步驟:

**step.1**  
將手柄按住 Xbox 鍵 + BACK 鍵，轉接器的 LED 藍燈轉成 LED 紅燈，進入設定模式。



**step.2**  
再同時按下 BACK 鍵 + START 鍵，即可將設定全部清除。



**step.3**  
按下 Xbox 鍵，轉接器中的 LED 紅燈轉換成 LED 藍燈，代表退出設定模式。



更多詳細操作請上官網查詢 [www.brookaccessory.com](http://www.brookaccessory.com)

### Remap Key/Custom Buttons 使用設定步驟:

**step.1**  
將手柄按住 Xbox 鍵 + START 鍵，轉接器的 LED 藍燈轉成 LED 紅燈，即進入設定模式。



**step.2**  
轉移單一按鍵功能 (比如將 B 鍵變成 A 鍵使用)



**step.5**  
按下 Xbox 鍵，轉接器中的 LED 紅燈轉換成 LED 藍燈，代表退出設定模式。



單一按鍵功能轉移到復數鍵使用 (比如將 B 按鍵變成 X+B+A 三鍵使用)

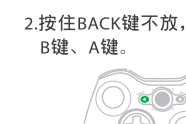

**step.5**  
按下 Xbox 鍵，轉接器中的 LED 紅燈轉換成 LED 藍燈，代表退出設定模式。



### 清除全部 Remap Key/Custom Buttons 使用設定步驟:

**step.1**  
將手柄按住 Xbox 鍵 + START 鍵，轉接器的 LED 藍燈轉成 LED 紅燈，進入設定模式。



**step.2**  
再同時按下 BACK 鍵 + START 鍵，即可將設定全部清除。



**step.3**  
按下 Xbox 鍵，轉接器中的 LED 紅燈轉換成 LED 藍燈，代表退出設定模式。



更多詳細操作請上官網查詢 [www.brookaccessory.com](http://www.brookaccessory.com)



# Game Controller Super Converters

Magic stick P4-GN

Xbox 360 ↔ PS4 Controller Adapter

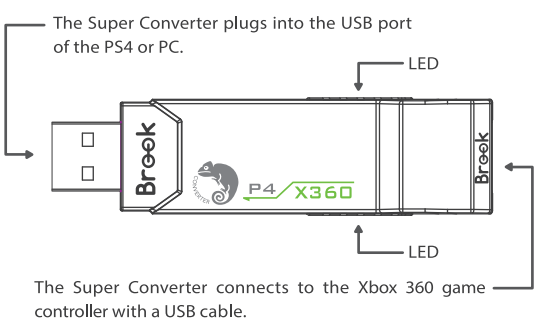

**step.1**  
Connect the Super Converter to the USB port of the PS4. The converter's blue LED will turn on to indicate a successful connection.

**step.2**  
Connect the Xbox 360 game controller to the Super Converter via a standard USB cable. The registration of the controller starts automatically and finishes when the port indicator light on the controller turns on or when pushing a button triggers a response on the screen.

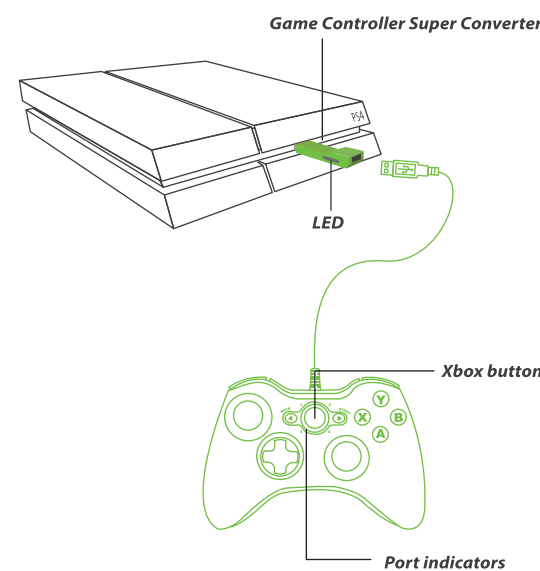

• Each Super Converter can handle one Xbox One game controller at a time.

The Super Converter automatically recognizes Xbox 360 gamepads and racing wheels and auto-configures their buttons for use with PS4.

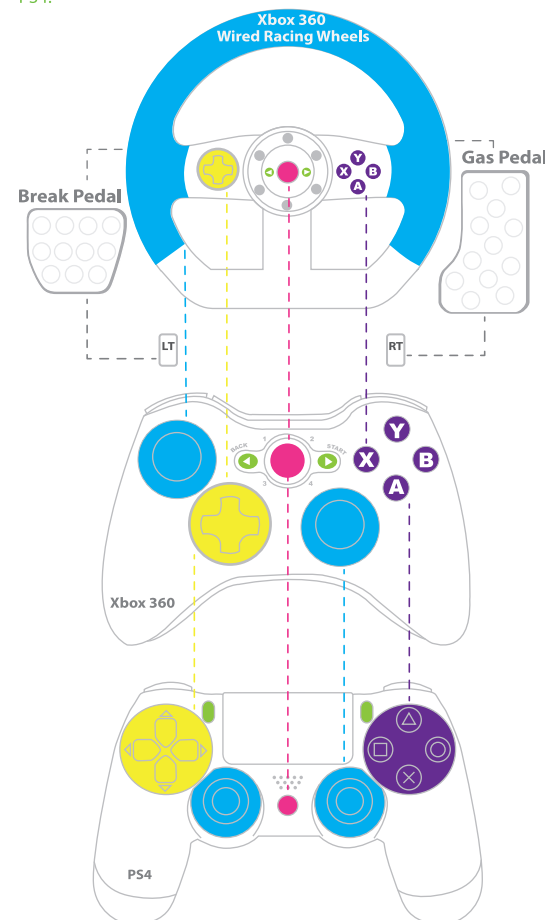

PS4 Gamepad	Xbox 360 Gamepad	Xbox 360 Racing Wheel	Xbox 360 Joystick
Dpad-UP	Dpad-UP	Dpad-UP	Dpad-UP
Dpad-Down	Dpad-Down	Dpad-Down	Dpad-Down
Dpad-Left	Dpad-Left	Dpad-Left	Dpad-Left
Dpad-Right	Dpad-Right	Dpad-Right	Dpad-Right
X	A	A	A
O	B	B	B
□	X	X	X
△	Y	Y	Y
OPTIONS	Start	Start	Start
SHARE	Back	Back	Back
Lx	Lx	Lx	--
Ly	Ly	--	--
Rx	Rx	--	--
Ry	Ry	--	--
L1	LB	LB	LB
R1	RB	RB	RB
L2	LT	LT	LT
R2	RT	RT	RT
L3	L3	--	--
R3	R3	--	--
PS Key	Xbox Key	Xbox Key	Xbox Key
Touchpad Key	L3+ R3	--	--

### Procedure for assigning a Turbo button

**step.1**  
Press the Xbox GUIDE and BACK buttons at the same time. The converter's LED will switch from blue to red to indicate that you enter the settings mode.



**step.2**  
Press and hold the BACK button and select which button you want to use for the turbo function. A single button or a combination of buttons can be chosen.



**step.3**  
Press the START button to complete the setting.



**step.4**  
Press the Xbox GUIDE button to exit the settings mode. The converter's LED will switch back from red to blue.



### Procedure for clearing a Turbo button assignment

**step.1**  
Press the Xbox GUIDE and BACK buttons at the same time. The converter's LED will switch from blue to red to indicate that you enter the settings mode.



**step.2**  
Press the BACK and START buttons at the same time to clear the current setting.



**step.3**  
Press the Xbox GUIDE button to exit the settings mode. The converter's LED will switch back from red to blue.



For more details please visit our official website at [www.brookaccessory.com](http://www.brookaccessory.com)

### Procedure for customizing buttons

**step.1**  
Press the Xbox GUIDE and START buttons at the same time. The converter's LED will switch from blue to red to indicate that you enter the settings mode.



**step.2**  
Transfer a function from one button to another. (Example: You want to use A to do what B does now.)



1.Press the B button.



2.Press and hold BACK, then press the A button.



3.Press START to complete the setting.

Transfer a function from one button to multiple buttons. (Example: You want to use X, B or A to do what B does now.)



1.Press the B button.



2.Press and hold BACK, then press X, B and A one by one (any sequence will do).



### Procedure for resetting all customizing buttons

**step.1**  
Press the Xbox GUIDE and START buttons at the same time to enter the settings mode. The converter's LED will switch from blue to red to indicate that you enter the settings mode.



**step.2**  
Press the BACK and START buttons at the same time to clear all settings.



**step.3**  
Press the Xbox GUIDE button to exit the settings mode. The converter's LED will switch back from red to blue.



### FCC Statement:

This device complies with part 15 of the FCC Rules. Operation is subject to the following two conditions:

- (1) This device may not cause harmful interference, and
- (2) this device must accept any interference received, including interference that may cause undesired operation.

NOTE: This equipment has been tested and found to comply with the limits for a Class B digital device, pursuant to part 15 of the FCC Rules. These limits are designed to provide reasonable protection against harmful interference in a residential installation.

This equipment generates, uses and can radiate radio frequency energy and, if not installed and used in accordance with the instructions, may cause harmful interference to radio communications. However, there is no guarantee that interference will not occur in a particular installation.

If this equipment does cause harmful interference to radio or television reception, which can be determined by turning the equipment off and on, the user is encouraged to try to correct the interference by one or more of the following measures:

- Reorient or relocate the receiving antenna.
- Increase the separation between the equipment and receiver.
- Connect the equipment into an outlet on a circuit different from that to which the receiver is connected.
- Consult the dealer or an experienced radio/TV technician for help. Changes or modifications not expressly approved by the party responsible for compliance could void the user's authority to operate the equipment.