

Photography copyright: Sami Paakkari 2012

USER INSTRUCTIONS

JJ-CCR Rebreather 

(Version 2.00 / Revision 07)



Reproduction and changes of this document and its content is prohibited without written approval from JJ-CCR ApS.

All information in this document has been carefully analyzed and is believed to be accurate. However, it is not possible to guarantee its accuracy and all liability is excluded. Cited companies and/ or product names are trademarks belonging to the respective companies.

General cautionary notes and warnings

- Never use the JJ-CCR Rebreather without receiving specific equipment training (basic course or crossover). It is essential receiving training from a factory approved instructor and from a factory approved training agency.
- These user instructions do not replace training with the equipment and are not directions for diving with closed circuit equipment.
- As with other equipment, it is possible that a Rebreather may fail at any time! It is therefore essential that an autonomous bailout system, independent of the equipment, be taken by the diver on every dive. The bailout system must be configured such that the dive can be terminated without difficulty in the event of a malfunction.
- Your knowledge and practical exercises are the best prerequisites for avoiding accidents.
- Modifications to the equipment result in the CE being voided immediately and it is no longer possible to guarantee a safe dive. This is also the case in the event of a failure to observe the service and maintenance intervals.
- Modifications to the equipment result in the warranty being invalidated. If modified equipment and/or parts are returned for repairs or maintenance then the equipment will be restored to its original format in the factory. Any parts and work required in order to do so will be billed for.
- Replacement parts, repairs and maintenance may only be carried out / shall only be supplied if the owner is able to provide verification that he possesses the requisite equipment-specific training.
- It is highly recommended that the user take the time to read through these user instructions in full.
- If you do not concur with the warnings provided then you should not dive with a JJ-CCR Rebreather.

1 Table of contents



1	Table of contents	3
1.1	Revisions and changes in documentation	7
1.2	Manufacturer	7
1.3	EC type examination	7
2	Introduction	8
3	JJ-CCR overview	9
3.1	JJ-CCR Scope of functionality	9
3.2	Technical specifications	10
3.2.1	Vertical head down position	11
3.2.2	Temperature conditions	11
3.2.3	Work rates	11
3.2.4	High-pressure oxygen	11
3.2.5	Expected inspired gas concentrations	12
3.2.6	Visibility	12
3.2.7	Use of high oxygen content gases	12
3.2.8	Potential long term health effects	12
4	Assembly of the JJ-CCR	13
4.1	Base unit	13
4.2	Handle	14
4.3	Stand	14
4.3.1	Attaching the stand to the base unit	15
4.4	1 st stages and hoses	16
4.5	Wing	17
4.6	Back-mounted counter lungs (BMCL)	17
4.7	Backplate and harness	18
4.7.1	Adjust the harness	19
4.8	Connecting the supplemental valves	20
4.9	Connecting the ADV	21
4.10	Connecting the wing inflator	21
4.11	Soda lime canister (axial)	22
4.12	Soda lime canister (radial)	23
4.13	Lid	24
4.14	Breathing hose with DSV (Dive Surface Valve)	26
5	Main components	27
5.1	Lid	27
5.1.1	Battery compartment	27
5.1.2	Oxygen sensors	28
5.1.3	Solenoid	28
5.1.4	Breathing hoses	28
5.2	Controller	29
5.3	HUD (Head Up Display)	29
5.3.1	Overview	30
5.3.2	PPO2 Display	31
5.3.3	Basic Commands	32

5.3.4	Turning On	32
5.3.5	Entering Commands	32
5.3.6	Turn-Off Command	33
5.3.7	Calibrate PPO2 Command	33
5.3.8	Alarm and Error messages	34
5.3.9	Advanced Options	35
5.3.10	Color Blind Code	36
5.3.11	Flip orientation	36
5.4	ADV (Automatic Diluent Valve)	37
5.5	Manual supplemental oxygen valve	37
5.6	Manual supplemental diluent valve	37
5.7	DSV (Dive Surface Valve)	37
6	Controller	38
6.1	Overview	38
6.2	Functionality	39
6.3	DiveCAN Architecture	40
6.4	Turning on the controller	41
6.5	Left and right buttons	41
6.5.1	Left (MENU)	41
6.5.2	Right (SELECT)	42
6.5.3	Overview of the button functions	42
6.6	The main display	43
6.7	Compass	46
6.7.1	Mark Heading (Compass)	47
6.8	Menu structure	48
6.9	Menu reference	49
6.10	Turn Off	49
6.11	Calibrate (calibration of the O2 sensors)	50
6.11.1	PPO2 monitoring	51
6.11.2	Checking calibration during a dive	52
6.12	End Dive	52
6.13	Switch Setpoint	52
6.14	Select Gas	53
6.15	Switch CC/BO (Between Closed and Open Circuit Bailout Mode)	54
6.16	Dive Setup	54
6.16.1	Low SP (Low Setpoint)	55
6.16.2	High SP (High Setpoint)	55
6.16.3	Define Gas	56
6.16.4	Dive Planner	58
6.16.5	Conserv.	61
6.16.6	NDL Display (GF99, CEIL, NDL, @+5 or Δ+5 display)	62
6.16.7	Brightness	63
6.17	Start Bluetooth	64
6.18	Dive Log	64
6.18.1	Display Log / Edit Log	64
6.18.2	Display Log / Edit Log	65
6.18.3	Restore Mode Off	66
6.18.4	Delete All Logs	66
6.19	Reset Stack Time	66
6.20	Setpoint -> .19	67

6.21	System Setup	67
6.21.1	Mode Setup	68
6.21.2	Salinity (Mode Setup)	68
6.21.3	Low Setpoint (Mode Setup)	68
6.21.4	High Setpoint (Mode Setup)	69
6.21.5	Deco Setup (Overview)	69
6.21.6	Conserv. (Deco Setup)	69
6.21.7	Last Stop (Deco Setup)	70
6.21.8	NDL Display (Deco Setup)	70
6.21.9	BO Gases	71
6.21.10	CC Gases	72
6.21.11	O2 Setup (Overview)	73
6.21.12	Cal. FO2 (O2 Setup)	73
6.21.13	Sensor Disp (O2 Setup)	74
6.21.14	Auto SP Switch	74
6.21.15	Display Setup (Overview)	76
6.21.16	Depth Units (Display Setup)	76
6.21.17	Temp. Units (Display Setup)	76
6.21.18	Brightness (Display Setup)	76
6.21.19	Altitude (Display Setup)	77
6.21.20	Flip Screen (Display Setup)	77
6.21.21	Compass (Overview)	78
6.21.22	Compass View (Compass)	78
6.21.23	Calibrate (Compass)	79
6.21.24	True North (Compass)	79
6.21.25	System Setup (Overview)	79
6.21.26	Date (System Setup)	79
6.21.27	Clock (System Setup)	80
6.21.28	Unlock (System Setup)	80
6.21.29	Reset to Defaults (System Setup)	80
6.21.30	Advanced Config (Overview)	81
6.21.31	System Info (Advanced Config)	81
6.21.32	Battery Info (Advanced Config)	81
6.21.33	Main Color (Advanced Config 1)	82
6.21.34	Title Color (Advanced Config 1)	82
6.21.35	End Dive Delay (Advanced Config 1)	82
6.21.36	Bat Icon (Advanced Config 1)	82
6.21.37	Gas Select (Advanced Config 1)	83
6.21.38	Advanced Config 2 (Overview)	83
6.21.39	Advanced Config 3 (Stack Timer)	84
6.22	Bus Devices	84
6.22.1	SRI Petrel (Bus Devices)	85
6.22.2	SRI SOLO (Bus Devices)	85
6.23	Info Screens	86
6.24	Alarm, error and info messages	90
6.25	Changing the battery	95
6.25.1	Battery Types	97
6.26	Firmware Update	98

6.27	Step-by-step Firmware Update	98
6.28	Controller Personalization (Start-Up Text)	99
7	Gas Select (New / Classic)	100
7.1	Gas Select (New Style)	100
7.2	Define Gas (New Style)	101
8	VPM-B / VPM-GFS decompression model	101
8.1	Deco Model	101
8.2	Conserv. (VPM)	102
9	Checklist prior to diving	103
9.1	Preparations on land	103
9.2	Shortly prior to diving	104
9.3	Shortly after entering the water	104
10	Diving	105
11	After the Dive	105
12	Cleaning	105
12.1	"Quick" Cleaning	105
12.2	"Complete" Cleaning	106
13	Storage	106
14	Maintenance	107
14.1	General Care	107
14.2	Maximum Service Life	107
14.3	Approved care products	107
14.4	Care Intervals	108
14.4.1	Prior every dive	108
14.4.2	After every dive	108
14.5	Maintenance Intervals	108
14.5.1	Every 12 months	109
14.5.2	Every 24 months	109
14.5.3	Every 60 Months	109

1.1 Revisions and changes in documentation

Revision	Description	Author
00	JJ-CCR Rebreather (DiveCAN®) - CE Edition	Dietmar Inäbnit
01	Wrong chapter numbers corrected Changed the on board gas calculation from 1.0 liter oxygen consumption to 1.78 (EN14143 section 6.6.3) Added chapter 3.2.1 - "Vertical head down position"	Dietmar Inäbnit
02	Updated for controller firmware v18 Some minor text changes and corrected typo	Dietmar Inäbnit
03	Updated for controller firmware v21	Dietmar Inäbnit
04	Updated for controller firmware v27 The compass requires mainboard v3.4.0 or higher	Dietmar Inäbnit
05	Updated for controller firmware v44 CE and International Edition user instructions merged into one document. Some minor text changes and corrected typo	Dietmar Inäbnit
06	Some minor text changes and corrected typo	Dietmar Inäbnit
07	Updated for controller firmware v53	Dietmar Inäbnit

1.2 Manufacturer

The JJ-CCR Rebreather is proudly manufactured in Denmark by:

JJ-CCR ApS, Dyrlevvej 11, 4720 Presto / www.jj-ccr.com

1.3 EC type examination

EC type examination conducted by SGS United Kingdom Ltd, SGS United Kingdom Limited: 202b, Worle Parkway, Weston-super-Mare, BS22 6WA, United Kingdom. Notified Body 0120.

2 Introduction

Congratulations on purchasing the JJ-CCR Rebreather. We are certain that you will experience many unforgettable dives using this equipment.

The development and testing of the JJ-CCR Rebreather started back in 2006. During this period the equipment was able to demonstrate exceptional reliability over more than 1500 diving hours at a wide range of locations around the world prior the first public release.

The product development philosophy is aligned with the following criteria:

- Strict application of the KISS principle: "Keep It Simple Stupid".
- The Rebreather must be extremely solid, versatile and reliable.
- The Rebreather must be very simple to use, maintain and service.
- The use of easy to obtain parts, enabling on-site repairs at any time.
- The support of a wide range of tank sizes without requiring any special adjustments to the equipment.
- The supply of fully operational equipment and not basic equipment with numerous different options.
- The equipment must be configured to include a very high level of redundancy. For example, separate batteries for the controller, HUD and solenoid. No batteries are permitted within the circuit. And it must be possible at all times to manually operate the Rebreather in the event of the controller failing.
- The use of simple and above all reliable electronics. No use of any high tech gimmicks and strict avoidance of an "autopilot effect". The diver retains full control of the Rebreather and not vice versa.
- Availability of scientific test records in order to verify the equipment performance.
- Always on the search for new ways of further improving the equipment.

3 JJ-CCR overview



3.1 JJ-CCR Scope of functionality



- Highly robust aluminium housing to which it is possible to secure up to 4 diving tanks (2 – 12 litre) using conventional tank belts.
- Self-filling soda lime canister (axial).
- Heavy duty stand.
- Integrated handle.
- Back-mounted counter lungs.
- Redundant power supply: One battery for the controller, one battery for the HUD and two parallel batteries for the solenoid. None of the batteries are integrated into the circuit.
- Integrated ADV (Automatic Diluent Valve).
- DSV (Dive Surface Valve).
- Manual supplemental O₂ and diluent valves with the option of feeding in external gases.
- Independent HUD (Head Up Display) with real-time display of PPO₂ for all three oxygen sensors.
- Reliable controller with an integrated multi-gas decompression computer (based on the Shearwater Petrel 2).

3.2 Technical specifications



Dimensions	70cm x 40cm x 26cm including the handle
Weight	34.2kg – Ready for operation with 2 x 3 litre tanks 19,8kg – Without tanks and soda lime
Soda lime canister	<p>Type: Axial Soda lime: Average 2.5kg (Sofnolime 797) Running time: 180 min with dive profile (40 m) 180 min with dive profile (100 m)</p> <p>Dive profile: 40 min at 40 m, 5 min at 15 m, 9 m for the remaining time</p> <p>Dive profile: 10 min at 100 m, 1 min at 39 m, 1 min at 36 m, 2 min at 33 m, 2 min at 30 m, 2 min at 27 m, 3 min at 24 m, 4 min at 21 m, 4 min at 18 m, 6 min at 15m, 7 min at 12 m, 10 min at 9 m, 6 m for the remaining time</p> <p>Test parameter: 40l/min air, 1.6l/min CO₂, 4°C water temperature</p> <p>Used diluent: 40 m - Air 100 m - Trimix 11/65</p>
Soda lime	The only supported soda lime is: Sofnolime® 797 manufactured by Molecular Products.
Oxygen Cylinder	3 Liter steel cylinder (200 bar)
Diluent Cylinder	3 Liter steel cylinder (200 bar)
On board gas duration	<p>Oxygen: The on board oxygen supply will last 252 minutes, if the diver consumes 1.78 liter of oxygen per minute.</p> <p>3 liter x 200 bar = 600 liter - 25% reserve = 450 liter</p> <p>Diluent: The duration depends on the depth and activity of the diver.</p> <p>3 liter x 200 bar = 600 liter</p>
Batteries	<p>2 x 3.6v lithium (SAFT 14500). One battery for the controller and one battery for the HUD.</p> <p>2 x 9v block lithium (Parallel operation for the solenoid)</p>
Volume of the counter lungs	8 litres
Maximum application depth	<p>Max. 40 m with air as diluent Max. 100 m with trimix as diluent</p> <p>Warning: Dives exceeding a depth of 100 m are associated with numerous additional risks</p>
Purity of the gases	<p>Air: DIN EN 12021 Oxygen: >99.5% (medicinal oxygen) Helium: >99.996</p>
Atmospheric pressure range	800 – 1050mbar

1 st stage "oxygen"	CE Edition - Connection: M26x2 - medium pressure: 7.0 to 7.5 bar International Edition - Connection: DIN 5/8" - medium pressure: 7.0 to 7.5 bar
1 st stage "diluent"	CE Edition - Connection: DIN 5/8" - medium pressure: 9.0 to 10.0 bar International Edition - Connection: DIN 5/8" - medium pressure: 9.0 to 10.0 bar
Oxygen control	Two oxygen setpoints (low and high). Can be switched as many times as required, also changeable under water.
Oxygen setpoint range	From 0.4 to 1.5 bar (low and high)
Oxygen warnings	Low 0.4 bar High 1.6 bar
Oxygen sensors	3 galvanic cells (type: R17JJ-CCR) - Output: 9-13 mV Shelf live: 3 months / Max. operating life 12 months after installation
Operating temperatures	When diving: +4°C to +34°C Short-term (air): -10°C to +50°C Long-term (storage) +5°C to +20°C

3.2.1 Vertical head down position

The JJ-CCR does not meet the requirements of EN 14143 section 5.6.1.4 (Hydrostatic imbalance test) with a pitch of -90 degrees (Vertical head down position). A vertical head down position during a dive is an extremely unusual position for a diver and normally never used when not absolutely necessary. Within a vertical head down position an unintentional activation or freeflow of the ADV can possibly occur. To avoid it when the diver is forced to a vertical head down position he can close the in line shut-off valve on the ADV and use the manual diluent adding valve to maintain an optimized loop.

3.2.2 Temperature conditions

The operating temperature for the JJ-CCR is between a minimum of 4° Celsius, and a maximum of 34° Celsius. Operation at temperatures outside of this range may lead to unreliable function.

3.2.3 Work rates

The JJ-CCR is intended for use on dives involving low to moderate work rates (E.g. normal recreational and technical diving activities). Although it is capable of sustaining divers operating with high work rates, this is not its intended purpose. At higher work rates the divers needs to take into account a reduced endurance. This is caused by a higher oxygen consumption and a higher CO₂ production which will reduce the running time of the soda lime. Additionally the diver needs to take into account, that a higher work rate can have an impact on the decompression and some additional safety margin should be added. Each body of course is different and reacts differently. Therefore it is not possible to specify exact numbers.

3.2.4 High-pressure oxygen

The JJ-CCR uses high pressure oxygen as one of its supply gas mixtures. The related parts has been cleaned and prepared specifically for use with high-pressure oxygen. The diver must taken special care. Especially when filling the oxygen cylinder. Very important is a proper maintenance and oxygen-compatible cleanless for all components exposed to high-pressure oxygen. Service and/or repair work for components exposed to high-pressure oxygen must be carried out by the manufacturer or by a service centre approved by JJ-CCR ApS. Failure to comply with these instructions could lead to an oxygen fire and may cause serious injury or death.

3.2.5 Expected inspired gas concentrations

The oxygen setpoint range of the JJ-CCR is from 0.4 to 1.5 bar (low and high). The setpoint range creates breathing gas mixture representing an inspired oxygen partial pressure between 0.4 bar and 1.5 bar. The default setpoints are 0.7 (low) and 1.3 (high) and they are user selectable within the listed setpoint range. The oxygen fraction of the mixture depends upon depth and set point. The following table shows the oxygen and nitrogen fraction with diluent "Air" and setpoint 0.7 and 1.3 to a depth of 50 meters.

Depth (m)	Abs. Pressure (bar)	Setpoint	PPO2 (bar)	O2 (%)	ppN2 (Bar)	N2 (%)
0	1.0	0.7	0.70	70	0.3	30
3	1.3	1.3	1.3	100	0	0
6	1.6	1.3	1.3	81	0.3	19
10	2.0	1.3	1.3	65	0.7	35
20	3.0	1.3	1.3	43	1.7	57
30	4.0	1.3	1.3	32	2.7	68
40	5.0	1.3	1.3	26	3.7	74
50	6.0	1.3	1.3	21	4.7	79

The nitrogen fraction will vary depending upon the selected diluent for a dive. To reach the maximum operating depth of 100 meters a trimix diluent is required. Diving deeper than the maximal recreational depth of 40 meters requires additional training, increases the over all risk and should only be carried out by trained divers.

3.2.6 Visibility

During a dive it is essential that the diver can read the information from the setpoint controller display and HUD. Therefore the JJ-CCR should only be used when the visibility in water exceeds approximately 30 centimeters. Using the JJ-CCR in visibility conditions that prohibit viewing of the setpoint controller display and HUD poses increased risks of operation.

3.2.7 Use of high oxygen content gases

CNS = Central Nervous System Oxygen Toxicity. Oxygen toxicity is a combination of oxygen pressure and time. The training for the JJ rebreather will cover CNS oxygen toxicity and the NOAA exposure limits.

Prolonged exposure to oxygen in excess of 0.5 bar can lead to pulmonary toxicity, affecting the whole body. Pulmonary toxicity is tracked using Oxygen Toxicity Units, known as OTUs for short. One OTU is earned by breathing 100% oxygen at one bar for one minute. The most conservative limit sets a maximum of 300 OTUs per day for multi day diving trips.

3.2.8 Potential long term health effects

There are no long term studies available for using a rebreather. It is the responsible of the diver to inform himself of the consequences of CNS, OTU's and the effect of decompression, emerged in water.

4 Assembly of the JJ-CCR



This chapter deals with the basic assembly of the JJ-CCR Rebreather. The equipment is fully assembled at the time of delivery. This chapter is primarily intended to show how the basic assembly takes place. At the same time, it acts as a guideline for correctly reassembling the equipment if it proves necessary to disassemble it for any reason (e.g. transportation for a dive trip).

4.1 Base unit



The base unit of the JJ-CCR consists of a highly stable aluminium housing. The guide rails shown in the image hold the selected diving tanks in the correct position and they are also used to attach the tank belts.



On the front side it is possible to see two screw retainers and a tube on both the right and left hand side respectively.



The following image shows how the screw (lock screw M8x30) is inserted in the screw retainer. Both screw retainer openings are arranged such that an unintentional loosening of a connection will not result in the base unit falling off. The plastic section of the screw forms a galvanic partition between the aluminium of the base unit and the rustproof steel of the screw. This prevents corrosion. The wing, counter lung and back plate are secured on the screws later.

4.2 Handle ●●●



The following image shows the handle, which is screwed into the two tubes on the base unit. The handle facilitates easy lifting of the JJ-CCR under all circumstances. The two tubes can be used for an additional trim weight. **Important:** Regardless of whether trim weights are used in the tubes or not, the overall trim of the JJ-CCR will not change! The only difference is the required quantity of lead on the diver's lead belt.



It is possible to use two types of trim weights. One can either opt for lead shot or lead bars. If lead shot is used then it is first necessary to insert a small piece of sponge into the tubes. This prevents the lead shot from falling out. At the same time, the sponge allows the water to run out.

4.3 Stand ●●●

The heavy duty stand is secured to the base plate of the base unit with 4 lock screws. The stand prevents the JJ-CCR from falling and can also be used as a fastening point for stages, wheels, buoys, etc. whilst diving.



4.3.1 Attaching the stand to the base unit ●●●



When attaching the stand it is first necessary to insert the base plate into the base unit from above. Before inserting the base plate it is necessary to ensure that the sealing surfaces of the base unit are clean. Carefully check the two base plate O-rings and re-grease these if necessary. When doing so, do not use excessive grease but simply apply a light coating. It must be possible to insert the base plate without applying force and without excessive effort.



During the next step the four lock screws are inserted into the base plate. Afterwards, attach the two blocks. An arrow is marked on the base unit and a notch is visible on the block. These serve to ensure the correct alignment of the stand. The stand is now secured. Important: Do not tighten the four nuts yet because it is first necessary to align the stand correctly. The stand is properly aligned if the arrow on the base unit points precisely to the notch in the block. It is now possible to tighten the self-locking nuts. The following image shows the stand correctly attached.



All parts are shown once again here in overview.

4.4 1st stages and hoses ●●●

The next assembly step concerns the 1st stages and hoses (low pressure and high pressure). When developing the JJ-CCR, extensive value was placed on clear and simple hose guidance. A further primary objective was to ensure that the equipment was fitted with the minimum possible number of hoses.



The 1st stage with the M26x2 connection and the green pressure gauge is used for oxygen. A low pressure hose line delivers the oxygen for the solenoid and the second hose is connected with the manual supplemental oxygen valve. The oxygen pressure relief valve triggers if the medium pressure rises to 10 bar, and thereby prevents the hoses from rupturing if, for example, icing up should occur. The 1st stage with the DIN 5/8" connection and the black pressure gauge is used for diluent. From the 1st stage a hose goes to a small 3-way manifold. Here, the three hoses are connected with the ADV, manual supplemental diluent valve and wing inflator. The diluent pressure relief valve triggers if the medium pressure rises to 15 bar, and thereby prevents the hoses from rupturing if, for example, icing up should occur.



The image to the left shows how the first two stages are connected to the diving tanks. Arrangement of the high pressure and low pressure hoses differs! It is very important to ensure that the hoses are arranged as shown in the image!

The image to the right shows the correct position of the 3-way manifold, which must lie flush with the housing.



4.5 Wing ●●●



The next assembly step concerns the wing. The JJ-CCR Rebreather is supplied with one wing, which is optimally tailored to the equipment and has been specially developed for it. The following image shows the correct hose arrangement. The two high pressure hoses must be fed through the lower opening in the wing. All hoses from the diluent must run through the upper opening. In the case of the oxygen, it is only necessary to run the hose for the manual supplemental oxygen valve through the upper opening.

The special position of the pressure gauges is advantageous for a number of reasons. During the pre-dive check they are very easy to read, whilst their position is completely out of the way during the dive. If, during a dive, it is necessary to check the tank pressure (oxygen or diluent) then it is very easy to reach both pressure gauges and to pull these forward.

4.6 Back-mounted counter lungs (BMCL) ●●●

Next, the back-mounted counter lungs are attached. The holes permit attachment of the back-mounted counter lungs at various heights.



The fast drain valve must be fed through the loop on the wing.

ATTENTION: Never attempt to lift the equipment using the ADV or T-piece. This can cause serious damage to the counter lungs!

4.7 Backplate and harness ●●●

The counter lung must be fastened to the harness. The top section of the counter lung is fitted with two fastening straps with Velcro for this purpose. The Velcro must be opened and one strap must be fed between the harness and the shoulder padding. The second strap is then used in order to close the Velcro fastening. The straps with Velcro must not be placed over the shoulder padding!



The following diagram shows the correct fastening of the counter lung to the harness.



A washer and wing nut are attached to the backplate. From time to time it is necessary to check whether the wing nut requires tightening, or if it has loosened at all.

4.7.1 Adjust the harness



The harness is supplied fully assembled together with the back plate. However, it is essential that the harness is adjusted to the physical dimensions of the diver. The JJ-CCR Rebreather must always sit as high as possible on the diver's back. It is also necessary to ensure that the equipment sits as tight to the back as possible.

- The JJ-CCR Rebreather is supplied with an adjustable harness. This enables very simple adjustment when putting on, and it is also possible to make underwater re-adjustments if necessary.
- A poorly adjusted harness can have an extremely negative effect on the comfort of the wearer during a dive.

The following images show both correct and incorrect adjustment. The right hand image shows the harness following incorrect adjustment, with the equipment sitting too low on the back. The left hand image shows the harness following correct adjustment, with the equipment sitting in the correct position the diver's back.



CORRECT



INCORRECT

4.8 Connecting the supplemental valves

The JJ-CCR comes with two supplemental valves. The oxygen valve enables the manual supply of oxygen via the t-piece into the breathing circuit. The diluent valve enables the supply of diluent via a second connection on the ADV into the breathing circuit.

Connect the low pressure oxygen hose (inflator connection) with the manual supplemental oxygen valve. It is recommended that both hoses be fed to the manual supplemental oxygen valve through the D-ring (see image). In this way the supplemental oxygen valve always remains in the same position, even during a dive.

Connect the longest low pressure diluent hose (inflator connection) with the the manual supplemental diluent valve. It is recommended that both hoses be fed to the manual supplemental diluent valve through the D-ring (see image). In this way the supplemental diluent valve always remains in the same position, even during a dive.



4.9 Connecting the ADV ●●●



Connect the shortest low pressure hose with the in-line shut-off valve from the 1st stage (diluent) with the ADV.

Never use any form of tool for this action! It is entirely sufficient for the connection to be hand-tight.

4.10 Connecting the wing inflator ●●●



The hose with the inflator connection is connected to the inflator from the wing and the complete assembly is then pushed through the inflator retainer on the harness. In this way the inflator always remains in the same position, even during a dive.

4.11 Soda lime canister (axial) ●●●

The JJ-CCR Rebreather is supplied with an axial soda lime canister.

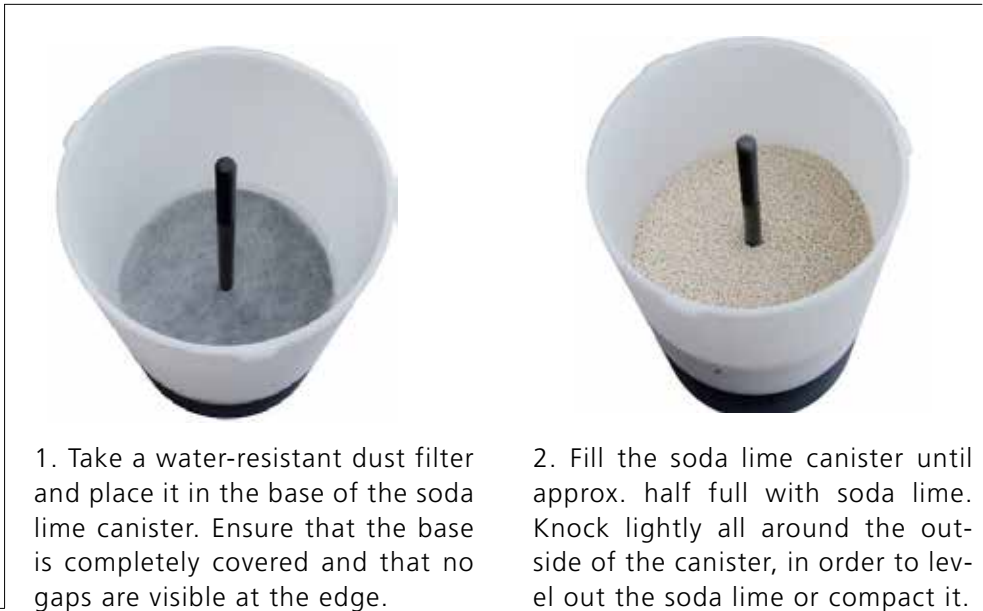

1. Take a water-resistant dust filter and place it in the base of the soda lime canister. Ensure that the base is completely covered and that no gaps are visible at the edge.

2. Fill the soda lime canister until approx. half full with soda lime. Knock lightly all around the outside of the canister, in order to level out the soda lime or compact it.



3. Fill the soda lime canister once more until you can see clearance of 4-5mm. Knock lightly all around the outside of the canister, in order to level out the soda lime or compact it. Now place the second dust filter on top of the soda lime.

4. Place the spring pressure plate on the dust filter and tighten the nut until it is hand-tight. Then knock lightly all around the outside of the canister, in order to level out the soda lime or compact it. The nut will usually loosen a little during this process and must be hand-tightened again afterwards. ATTENTION: Please do not tighten the nut excessively as this can damage the soda lime canister. The soda lime canister is correctly filled if shaking it does not result in noise being heard from the soda lime.

IMPORTANT: Soda lime that has already been used must never be used for another dive.

4.12 Soda lime canister (radial) ●●●



FOR INTERNATIONAL EDITON ONLY: The radial soda lime canister is available as an option to the JJ-CCR.

- The radial soda lime canister must be filled extremely carefully and it is essential to ensure that the soda lime is correctly compacted.
- In order to fill the radial soda lime canister correctly, take a minimum of 10 minutes for this action.



A water-resistant dust filter is located on the inner tube. This prevents dust from the soda lime from entering the inhalation side of the breathing circuit. In order to replace the dust filter it is possible to simply screw out the entire inner tube. The dust filter is attached by three O-rings.

The radial soda lime canister must be filled in stages. At each stage, approx. 5 – 7 cm of soda lime should be added. Each time soda lime is added this must then be compacted. This is most simply carried out by knocking right around the edge of the black section of the soda lime canister. Fill the soda lime canister until you can see clearance of 4-5mm. Knock lightly all around the black section of the canister, in order to level out the soda lime or compact it.



Never knock on the top section (= grate) of the soda lime canister in order to compact the soda lime. This could damage the soda lime canister.

IMPORTANT: Soda lime that has already been used must never be used for another dive.

Insert the spring pressure plate and tighten the nut until it is hand-tight. Then knock lightly all around the black section of the canister, in order to level out the soda lime or compact it. The nut will usually loosen a little during this process and must be hand tightened again afterwards. The pressure plate must be flush with the soda lime canister. The soda lime canister is correctly filled if shaking it does not result in noise being heard from the soda lime.

4.13 Lid ●●●

The lid and the soda lime canister are screwed together with a quarter turn and sealed with an O-ring. This O-ring must be checked carefully prior to assembly! Never tighten the soda lime canister excessively!



Before placing the lid with the soda lime canister into the aluminium housing, the two O-rings must be very carefully checked and re-greased if necessary. When doing so do not use excessive grease but simply apply a light coating. This is a very important point as it is otherwise possible that the rebreather may leak which may cause serious risk to the user and severe damage to the rebreather.

A leakage in this area will most likely be discovered during the positive and negative pressure test!



Align the lid such that the stud and the hole in the aluminium housing line up with each other.



Push down on the stud and start to push the lid slowly down with the soda lime canister.



The correct position has been attained once the stud pokes out of the hole in the aluminium housing.



Push both the HUD and the controller through the handle.



Now connect the oxygen low pressure hose. **Only tighten until hand-tight!**



Take both breathing hoses and feed these through the handle. Afterwards, your equipment should be in position as in the image above.

Note: The breathing hose in the centre of the lid is for the inhalation side and is always connected to the ADV!



Connect the breathing hoses to the T-piece and ADV. It is not possible to connect these incorrectly because the two connection threads are different. The connection thread on the inhalation side (ADV) is clockwise, whilst the thread on the exhalation side (T-piece) is anti clockwise.

ATTENTION: Never attempt to lift the equipment using the ADV or T-piece. This can cause serious damage to the counter lungs!

4.14 Breathing hose with DSV (Dive Surface Valve)



It is now possible to connect the breathing hose with the DSV (Dive Surface Valve).



Before connecting the breathing hose it is always necessary to check that both check valves are operating correctly!

The arrow on the DSV indicates the flow direction of the breathing circuit. It is not possible to connect the breathing hose incorrectly because the two connection threads are different. The connection thread on the inhalation side (ADV) is clockwise, whilst the thread on the exhalation side (T-piece) is anti clockwise.



Take the HUD and feed it through the two red O-rings on the breathing hose. Then push it into the retainer on the DSV.

The JJ-CCR Rebreather is now fully assembled and the assembly chapter is hereby complete.

For detailed information on the individual main components of the JJ-CCR Rebreather refer to the respective chapters.

WARNING: The equipment is not yet ready for diving! It is always necessary to carry out the pre dive checks in accordance with chapter 9!

5 Main components ●●●

This chapter provides descriptions of some of the main components of the JJ-CCR Rebreather and also includes a few essential maintenance and care instructions.

5.1 Lid ●●●



The lid with the three oxygen sensors, solenoid, battery compartment, and connectors for controller and HUD is effectively the brain of the JJ-CCR Rebreather. On the right hand side is the connection for the low pressure oxygen hose to the solenoid. Under the cap engraved with "JJ-CCR" is the battery compartment.

IMPORTANT: The lid should always be treated with the utmost care.

5.1.1 Battery compartment ●●●



IMPORTANT: Only 9 volt block batteries with rounded edges will fit.

In order to open the battery compartment it is necessary to remove the 10 screws from the battery compartment. The JJ-CCR Rebreather has an extremely low energy consumption. The batteries usually have a lifetime between 6 to 12 months.

A design feature of the JJ-CCR Rebreather is the arrangement of the batteries. As shown in the image, no batteries are integrated into the breathing circuit and the battery compartment is completely sealed. As such battery problems never arise due to increased moisture, which would have been the case within the breathing circuit. Furthermore, the batteries are not exposed to any pressure changes in the battery compartment. Problems with batteries, that may be attributed to severe changes in pressure, are therefore fully excluded with the JJ-CCR Rebreather. Due to the complete sealing of the battery compartment, a fully flooded breathing circuit will also have no effect on the batteries. The two 2 x 9v block lithium batteries are used in parallel for the solenoid. When replacing the batteries please always change both batteries! The current voltage of the batteries can be checked on the status display on the controller. The controller also issues an external battery warning (Low Battery EXT) if the voltage is too low. The 3.6v lithium battery (SAFT 14500) is for the HUD. Please ensure that the battery is inserted correctly into the battery holder. The battery holder is appropriately marked with "+" and "-" signs. It is recommended that the battery for the HUD always be replaced at the same time as both batteries for the solenoid.

5.1.2 Oxygen sensors ●●●

The JJ-CCR Rebreather uses three JJ-CCR oxygen sensors. The sensors can be exchanged in seconds without the use of a tool. **IMPORTANT:** Only use sensors of type "R17JJ-CCR"! The shelf live is 3 months and max. operating life is 12 months after installation.



The three cells are numbered (1, 2 and 3). These numbers can be found adjacent to the connection on the lid and above each cell.



The wiring of the sensors with the connections in the lid must be carried out correctly according to the numbers because the sequence (1, 2 and 3) corresponds with the display in the controller and the HUD.

5.1.3 Solenoid ●●●



The JJ-CCR Rebreather uses a special solenoid, which is characterised in particular by its extremely low power consumption. With this solenoid the defective operating state is always in the closed position – this dramatically reduces the potential for oxygen poisoning in the event of a malfunction.

- Service and/or repair work on the solenoid must be carried out by the manufacturer or by a service centre approved by JJ-CCR ApS!

5.1.4 Breathing hoses ●●●



Two breathing hoses are attached to the lid. The breathing hose in the centre is connected to the ADV and the breathing hose on the edge of the lid to the T-piece. In order to remove the two breathing hoses (refer also to chapter 12.2) it is necessary to remove the hex socket head screw with the washer. Afterwards it is possible to remove both hoses.

The two openings have different diameters and it is therefore impossible to incorrectly insert the breathing hoses when assembling.

5.2 Controller



The JJ-CCR Rebreather is supplied with a Shearwater Petrel 2 controller, which contains a multigas (nitrox, trimix, heliox) and multimode (Open and Closed Circuit) decompression computer. The firmware installed on the controller is optimized for the JJ-CCR Rebreather and contains capabilities and functions developed specially for the equipment.

For a detailed description of the controller refer to the chapter 6.

5.3 HUD (Head Up Display)



The JJ-CCR Rebreather is supplied as standard with an HUD (Head Up Display). The HUD functions fully independently of the controller. This means that it uses its own DiveCAN® bus, electronic and power supply. The essential features are:

- PPO2 display from 3 oxygen sensors.
- Modified Smither's code blink pattern.
- Bright light emitting diodes with vibrant colors.
- Color-blind blink pattern (optional setting).
- Wet contacts for automatic turn-on.
- DiveCAN® communications interface for robust data transmission and easy upgrades, disassembly and repairs.
- Bright red end-cap LED for buddy warnings.
- Automatic brightness control optimizes viewing in all conditions.
- Red color only used for unsafe PPO2 warnings.

5.3.1 Overview ●●●

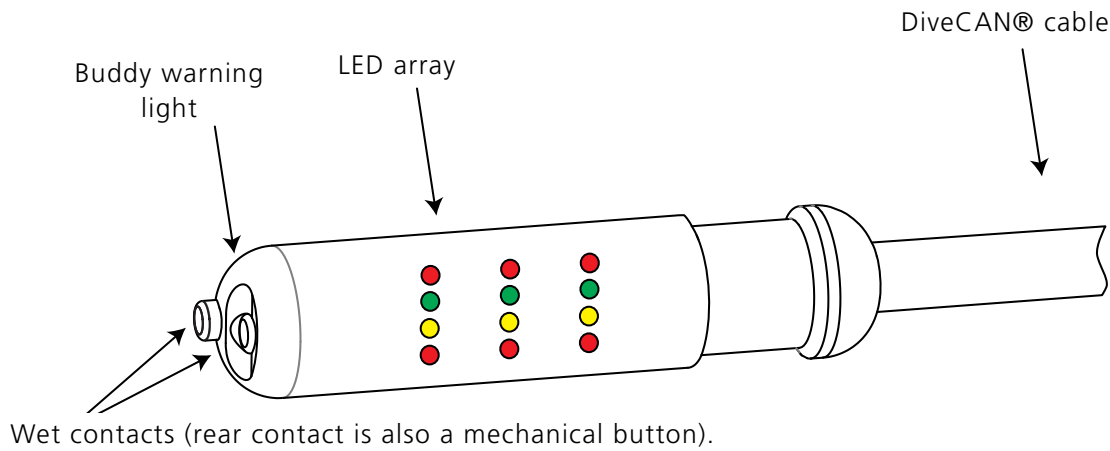

LED array: An array of colored light emitting diodes (LEDs) blink to display PPO2. For color-blind users, there is an optional blink pattern that uses position only to display PPO2

Buddy warning light: The buddy warning light pulses when PPO2 is outside a safe range.

Wet contacts: Wet contacts turn the HUD on automatically when wet. The rear contact is also a mechanical push button for entering commands.

Cable: The DiveCAN® cable provides a robust, disconnectable connection to the rebreather.

The default blink pattern is a modified Smither's code. As alternative a mode color-blind people can be chosen. PPO2 is displayed in absolute atmospheres (ata) with a resolution of 0.1 ata. For the purposes of this HUD, this can be considered the same as Bar. i.e. 1 ata ≈ 1 Bar.

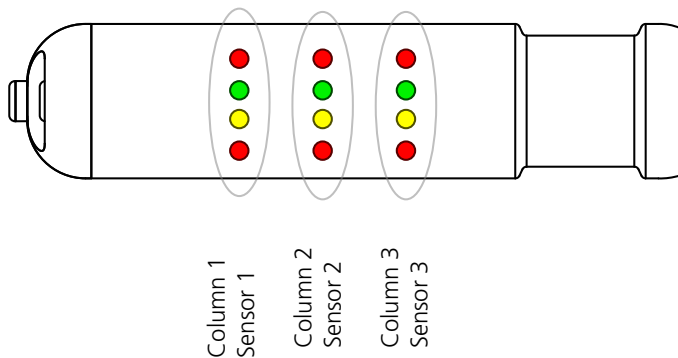

There are four rows of LEDs. Top is red. Next is green, then yellow. Bottom row is red.

Each column displays PPO2 from one O2 Sensor

A blinking LED is drawn with lines emanating from it. An LED that is on-steady is drawn solid. An off LED is not drawn.

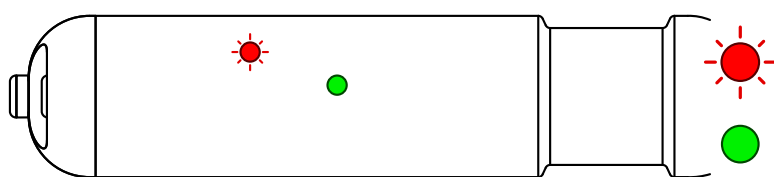

Red LED is blinking
Green LED is on solid
All other LEDs are off

5.3.2 PPO2 Display ●●●

The default PPO2 display is a modified Smither’s code. Blinks of color are used to display PPO2. Every 5 seconds a blink cycle begins. The blink pattern depends on the PPO2 range:

PPO2 Range	HUD Display	Blink Pattern
Above 1.6		Top-red blinks once for each 0.1 above 1.0 e.g. 1.7 = 7 top-red blinks
1.1 to 1.6		Green blinks once for each 0.1 above 1.0 e.g. 1.3 = 3 green blinks
1.0		1.0 = Green and yellow blink once together.
0.4 to 0.9		Yellow blinks once for each 0.1 below 1.0 e.g. 0.7 = 3 yellow blinks
Below 0.4		Bottom-red blinks once for each 0.1 below 1.0 e.g. 0.2 = 8 bottom-red blinks

The modified Smither’s code has some nice attributes that grab attention in abnormal or unsafe situations. A typical rebreather PPO2 setpoint will be about 0.7 to 0.8 for the low setpoint, and 1.2 to 1.3 for the high setpoint. Therefore, when the loop is at setpoint, you will expect to see 2 to 3 blinks per 5 second cycle. If the “light density” changes (i.e. you are seeing more or less blinks), then the setpoint is off target. This change in light density can grab your attention even if you have tuned out the blinking of the LEDs. Of course, we recommend paying attention at all times.

If the PPO2 falls below 0.4 or rises above 1.6, you will be seeing a lot of red blinking. Since red is not used at all in the normal safe PPO2 range, the presence of red is a clear signal that something is wrong.

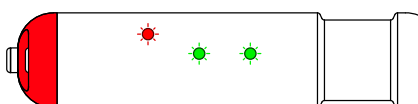

The sole function of the buddy red warning light is to alert that the PPO2 is outside the range of 0.4 to 1.6. If any O2 cell is outside this range then the warning light turns on. If the buddy warning light comes on, check your PPO2, consult your handset, and deal with the problem.

5.3.3 Basic Commands ●●●

Commands are entered by pressing the rear wet contact, which acts as a mechanical push button.

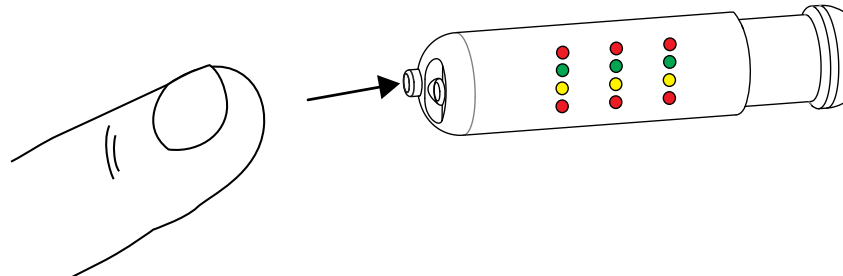

The basic commands are: Turn-on, Turn-off, PPO2 Calibration, Enter advanced Menu

5.3.4 Turning On ●●●

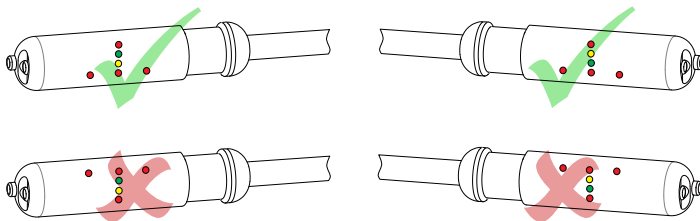

Turn the HUD on by pressing the button once. The HUD will also turn on automatically if the wet contacts detect water.

After turning on, each LED will light up briefly. Use this time to verify that each LED, including the buddy warning light, works properly.

- Do not use the HUD if any LED is not working.

After each LED has been turned on, an "UP" arrow will briefly display. This indicates which orientation the HUD has been set to use (Chapter 5.3.11).

5.3.5 Entering Commands ●●●

A Command is entered by:

1. Pushing and releasing the button until the correct command is selected.
2. Holding the button for 3 seconds to confirm the command.
3. The LEDs will then blink twice to show the command was accepted.

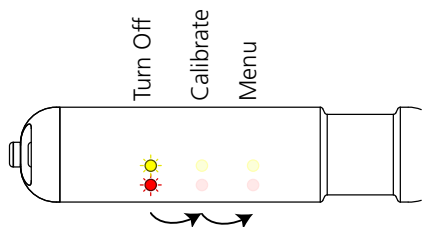

After the first button press, the bottom two LEDs of column 1 will blink. This is "command column 1" or the TURN-OFF command. Each button press advances the command column by one.

When the desired command is blinking, hold the button for 3 seconds to execute the command. The LED column will blink twice as a confirmation. The command will then execute.

- When the wet contacts detect water, the button inputs are disabled. This is to prevent entering commands while diving.
- If the button is not working, try rinsing in fresh water and then ensuring that the wet contacts are dry.

5.3.6 Turn-Off Command

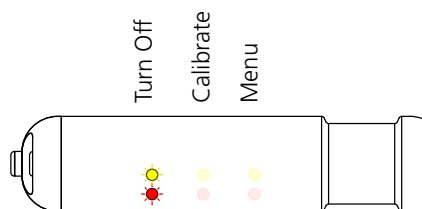

Turn off by holding the button for 3 seconds while on command column 1. The complete turn off sequence is:

1. Press once to enter 1st command column (TURN-OFF).
2. Hold for 3 seconds.
3. While holding, the 1st column LEDs count up. They blink twice to confirm the command.
4. HUD shuts off.

- Turn off the HUD when not in use to save battery power.
- The HUD will turn off by itself after 30 minutes of inactivity.
- However, the HUD will not turn-off if the wet contacts detect the presence of water.
- Ensure the wet contacts are dry before putting the HUD into storage.

5.3.7 Calibrate PPO2 Command

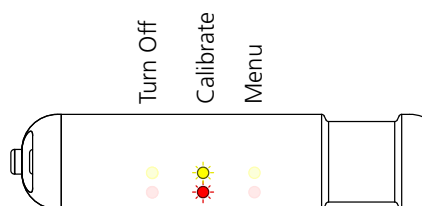

Perform the PPO2 calibration by holding the button for 3 seconds while on command column 2.

Calibration of the HUD should take place immediately after calibrating the controller! It is recommended that the HUD and controller always be calibrated at the same time!

The complete calibration sequence is:

1. Open the valve on the oxygen tank.
 2. Open the mouthpiece (=CC mode).
 3. Turn on the HUD.
 4. Start the calibration sequence for the controller (Chapter 6.11).
 5. Perform the following steps as quickly as possible, so that you can calibrate the HUD as soon as possible after completion of the controller calibration!
 6. Press once to enter 1st command column (TURN-OFF).
 7. Press again to advance to 2nd command column (CALIBRATE).
 8. Hold for 3 seconds.
 9. While holding, the 2nd column LEDs count up. They blink twice to confirm the command.
 10. The green and yellow LED rows then count up to indicate the calibration is in progress.
 11. Once the calibration completes, the HUD will return to the regular PPO2 display.
- The HUD only calibrates at a PPO2 of 1.0 ata. This means it assumes pure oxygen is used for the calibration, and it is performed at sea-level.

5.3.8 Alarm and Error messages ●●●

The following table shows alarm and error messages related to a failed calibration of the oxygen sensors:

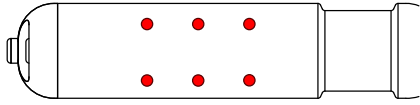
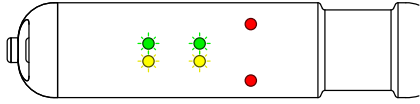
HUD Display	Description	Troubleshooting
 <p>Top and bottom red LEDs on solid</p>	<p>All O2 sensors have failed calibration.</p>	<p>A good O2 sensor is expected to output between 30mV to 70mV in pure oxygen at sea-level.</p> <p>A sensor that does not meet these specs fails calibration. Fix the problem (e.g. replace the sensors) and recalibrate.</p>
 <p>Top and bottom red LEDs on solid (1 column)</p> <p>Other columns normal</p>	<p>One O2 sensor has failed calibration.</p> <p>In this case sensor #3 has failed.</p>	<p>It is possible for some sensors to pass calibration, while others fail.</p> <p>This indicates which sensor is faulty.</p> <p>See above for troubleshooting.</p> <p>Do not dive unless all sensor are functional!</p>

The following table shows alarm and error messages related to a failed DiveCAN® communication:

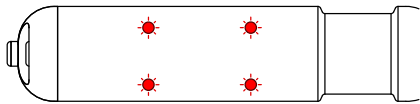
HUD Display	Description	Troubleshooting
 <p>Four corners blinking</p>	<p>No DiveCAN® Communications</p>	<p>Ensure the DiveCAN® cable connector is securely fastened.</p> <p>Contact Shearwater or your rebreather manufacturer for service.</p>

The following table shows alarm and error messages related to low battery voltage:

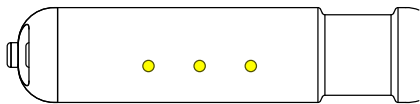
HUD Display	Description	Troubleshooting
 <p>After turn on, the yellow row stays on for 30 seconds</p>	<p>Battery is low and should be replaced</p>	<p>Replace the 3.6v Lithium Batterie (SAFT LS 14500). Refer to chapter: 5.1.1</p>

5.3.9 Advanced Options

There are two options that can be set by the user. 1) Choosing the PPO2 blink pattern. 2) Flipping the orientation to the other side of the rebreather mouthpiece.

- Flipping the orientation to the other side of the rebreather mouthpiece makes no sense with the JJ-CCR rebreather, as the HUD holder on the DSV is on the right side. This function is only useable, when somebody connects another DSV oder BOV to the JJ-CCR which allows to attach the HUD to the left side.
1. Turn the HUD on by pressing the button once.
 2. Press once to enter 1st command column (TURN-OFF)
 3. Press again to advance to 2nd command column (CALIBRATE).
 4. Press again to advance to 3rd command column (MENU).
 5. Hold for 3 seconds to enter the advanced options menu
 6. Once in the advanced options menu, the 1st column will alternately blink the top-red and bottom-red LEDs.
 7. Each press advances the option column by one position.
 8. Select the option by holding for 3 seconds while the option column is blinking
 9. An option column will time-out, returning to the regular PPO2 display after 20 seconds of inactivity. Also, an additional press when on the last option column will return to the regular PPO2 display.

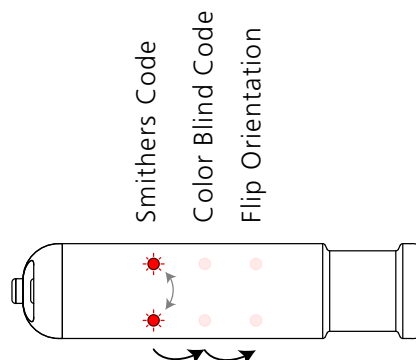

5.3.10 Color Blind Code

The optional color blind blink pattern uses positioning of the LEDs to indicate PPO2. Every 5 seconds a blink cycle begins. The blink pattern depends on the PPO2 range:

PPO2 Range	HUD Display	Blink Pattern
Above 1.6		Top row blinks once for each 0.1 above 1.0 e.g. 1.7 = 7 top row blinks
1.1 to 1.6		Upper-middle blinks once for each 0.1 above 1.0 Lower-middle row on solid e.g. 1.3 = 3 upper-middle blinks
1.0		1.0 = both middle rows on solid
0.4 to 0.9		Upper-middle row on solid Lower-middle blinks once for each 0.1 below 1.0 e.g. 0.7 = 3 lower-middle blinks
Below 0.4		Bottom row blinks once for each 0.1 below 1.0 e.g. 0.2 = 8 bottom row blinks

5.3.11 Flip orientation

The orientation can be flipped so that the HUD can be positioned on either side of the rebreather mouthpiece.

- Flipping the orientation to the other side of the rebreather mouthpiece makes no sense with the JJ-CCR rebreather, as the HUD holder on the DSV is on the right side. This function is only useable, when somebody connects another DSV oder BOV to the JJ-CCR which allows to attach the HUD to the left side.

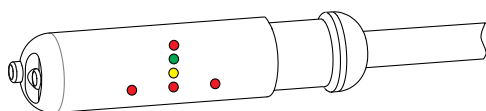

The first image shows the standard HUD orientation on the JJ-CCR rebreather. The HUD is located on the right side of the DSV.

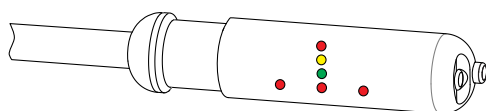

The second image shows the flipped HUD orientation. This allows the HUD to be located on the left side of DSV or BOV.

5.4 ADV (Automatic Diluent Valve) ●●●



The JJ-CCR Rebreather is supplied with an ADV. The ADV works in a similar way to a 2nd stage and supplies additional diluent to the breathing circuit if necessary. This is the case for example if considerable negative pressure exists in the breathing circuit. It is also possible to actuate the ADV manually by pressing down on the membrane cap. The ADV does not require any adjustment.

5.5 Manual supplemental oxygen valve ●●●



The manual supplemental oxygen valve feeds oxygen into the breathing circuit. The longer the button is depressed, the more oxygen is supplied to the breathing circuit. A light press of the button results in a small quantity of oxygen being fed into the circuit, whilst pushing down heavily on the button adds more oxygen. This facilitates very accurate adherence to the desired PPO2 when the Rebreather is operated in manual mode. It is possible to remove the connection hose and turn the valve through 180 degrees, in order to connect an external gas supply.

For example: The oxygen tank is empty and you have a bailout system with oxygen or another gas and now wish to manually feed this into the breathing circuit.

5.6 Manual supplemental diluent valve ●●●



This valve enables the manual supply of diluent into the breathing circuit. The longer the button is depressed, the more diluent is supplied to the breathing circuit. A light press of the button results in a small quantity of diluent being fed into the circuit, whilst pushing down heavily on the button adds greater diluent. It is possible to remove the connection hose and turn the valve through 180 degrees, in order to connect an external gas supply.

5.7 DSV (Dive Surface Valve) ●●●



The JJ-CCR Rebreather is supplied with a DSV. The JJ-CCR DSV is extremely compact and has a neutral weight in the water. Its movement is very smooth and it is possible to switch between open and closed using one hand. A retainer for the HUD is also integrated into the DSV.

ATTENTION: Before connecting the breathing hose with the DSV it is always necessary to check that both shutter valves are functioning correctly. It is also necessary to ensure that the DSV can be opened and closed with ease.

6 Controller

The JJ-CCR Rebreather is supplied with a controller, which contains a multigas (nitrox, trimix, heliox) and multimode (Open and Closed Circuit) decompression computer. The firmware installed on the controller is optimised for the JJ-CCR Rebreather and contains capabilities and functions developed specially for the equipment.

6.1 Overview



The controller is connected to the JJ-CCR Rebreather lid via a wet pluggable connection. The large-scale, high resolution LCD full colour display is visible on the top.

Somewhat to the right and behind the small hole in the panel is the brightness sensor. This measures the ambient light and automatically adjusts the brightness of the display to the respective ambient light.

One piezo button is situated to the left and one to the right respectively. The complete operation takes place using these two buttons. The piezo buttons used here offer the maximum in flexibility, a long service life and absolute reliability. They cannot catch in the same way as mechanical control buttons and there is no need to clean them in order to maintain their faultless and smooth functionality.

The battery compartment is located on the right hand side. This is very easy to open with a coin. The battery (SAFT 14500 – 3.6 volt lithium) can be replaced by the user. One battery has a service life of approx. 90 diving hours and 12 months in standby mode.

On the underside (covered by the arm strap retainer) is the opening for the pressure sensor.

One wet contact is on the underside and one on the right side. The controller turns on as soon as it comes into contact with water.

6.2 Functionality



- High resolution LCD full colour display (320 x 160 pixel)
- Air, nitrox, trimix and heliox adjustable as breathing gas
- Bühlmann GF (Gradient Factors) algorithm.
- VPM-B and VPM-B GFS algorithm (optional)
- GF values (low and high) and VPM conservatism adjustable by the user
- GF 99 Bailout and CEIL profile
- Switches on automatically with pressure, depth and water contact
- Closed circuit (CC) and open circuit (BO) bailout mode
- High altitude diving mode
- Up to 5 different gases for closed circuit and open circuit bailout mode
- PPO2 real-time display of 3 oxygen sensors including "Voting Logic"
- Display of the mV of the O2 sensors
- Auto-calibration of the oxygen sensors
- Oxygen content for calibration of the oxygen sensors adjustable
- Gas change and gas adjustments possible underwater at any time
- Very simple to change from a closed to an open circuit (BO) bailout mode
- Low and high setpoint can be defined (between 0.4 and 1.4)
- Low and high setpoint can be changed underwater at any time
- Automatic or manual change of the setpoints settable
- Use of the metric or imperial system
- Internal logbook four 1000 dive hours
- PC, MAC, iOS and Android dive log upload via Bluetooth
- Display showing the speed of ascent
- Display showing the battery voltage
- Display showing the date and time
- Display showing the water temperature
- CNS display
- Warning in the event of low battery voltage (internal and external)
- Alarm display if PO2 too low or high, or with failure to observe a decompression stop
- Automatic brightness adjustment of the display to the ambient light
- Display can be rotated through 180 degrees
- Very simple menu guidance with adaptive menus
- Firmware update can be carried out by the user (via Bluetooth)

6.3 DiveCAN Architecture

DiveCAN® is a digital communications standard developed specifically for rebreathers. The JJ-CCR uses two independent DiveCAN® busses. The handset (controller) is connected via the control bus to the SOLO board (Solenoid and Oxygen controller). The HUD uses the monitor bus and is connected to the Oxygen board (OBOE).

The SOLO and OBOE board are completely independent and each board is powered by its own power supply. The SOLO board power source are the two 9 volt block batteries, where as the OBOE board uses the 3.6 volt SAFT Lithium battery.

Modular design compartmentalizes critical functions for redundancy. For example, the Solenoid and Oxygen board (SOLO) can measure and inject oxygen independently of the handset. If the handset is unplugged or damaged, the SOLO can continue to control loop PPO2.

Components (handset, HUD, etc) can be easily removed for travel, repair, backup, and upgrades.

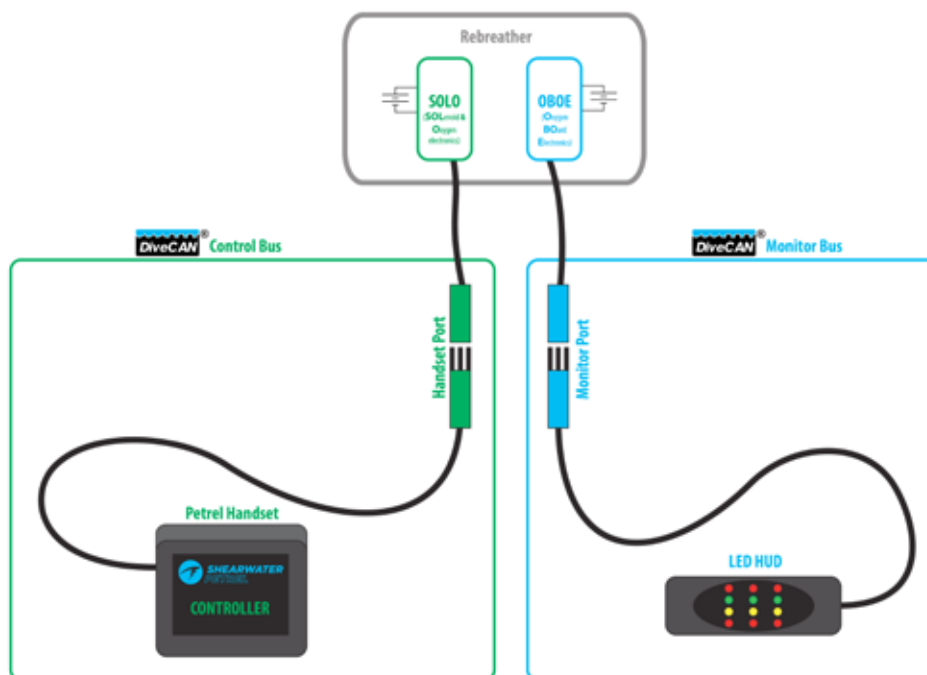

6.4 Turning on the controller ●●●

In order to turning on the controller press both buttons at the same time. The JJ-CCR logo appears for a brief time, following by the controller’s main display.

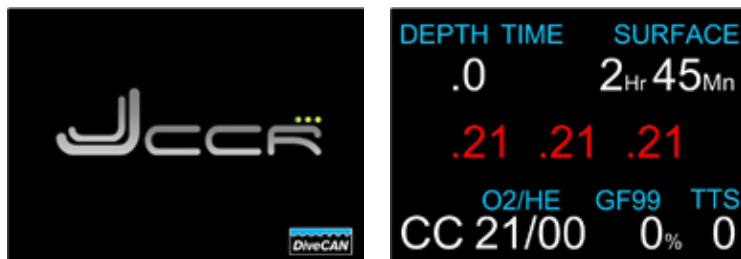

- For divers at high altitudes the surface pressure is determined by the following: When in sleep mode (off), the pressure is sampled every 10 seconds. The last 10 minutes of pressure samples are saved. Upon turn-on (regardless of the cause), the minimum pressure from the 10 minute pressure history is set as the surface pressure. The exception is when the battery is changed, since there is no 10 minute history. In this case it is assumed tha the unit is on the surface, so current pressure is used as the surface pressure.
- At the surface the controller turns off again automatically after 45 minutes.
- During the first 2 minutes after diving the controller maintains surface interval and it cannot be turned off at this time.

6.5 Left and right buttons ●●●

As previously described, complete operation of the controller is implemented via the two piezo buttons. Although both buttons also have special functions, it is possible to summarise the main function as follows:

6.5.1 Left (MENU) ●●●

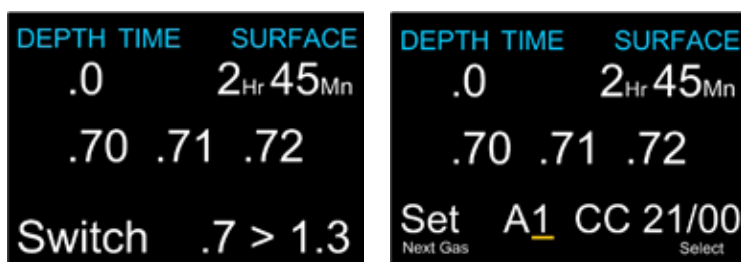

The left button (MENU) is used in order to scroll between the various controller menus. Or, if it is necessary to set a value, in order to increase this. In this way, one is able to press briefly on the left button in order to move from the “Switch Setpoint” menu to the “Select Gas” menu.

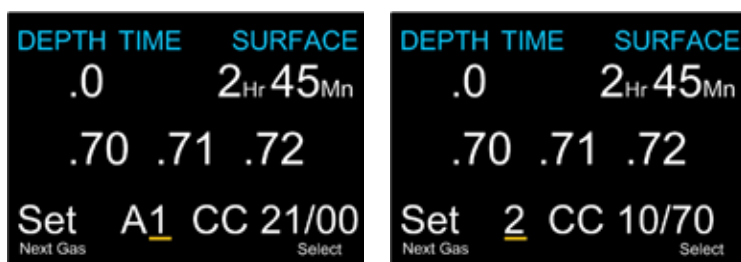

If one is in the “Select Gas” menu then pressing briefly on the left button will switch to the next gas.

6.5.2 Right (SELECT) ●●●

The right button (SELECT) is used in order to confirm the current selection. In some cases this can mean that an actual value is saved or a command is executed.

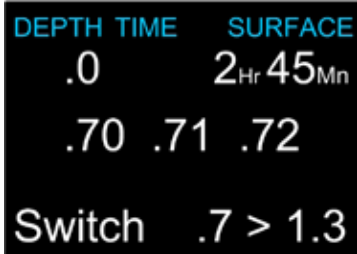

For example: If the user presses on the right button (SELECT) in the "Switch Setpoint" menu then the setpoint is changed to 1.3.

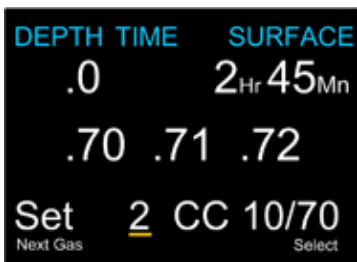

Or, if the user is in the "Select Gas" menu then pressing on the right button (SELECT) will select the displayed gas.

6.5.3 Overview of the button functions ●●●

The following table shows the various button functions:

Button	Description
Press both buttons simultaneously	The controller is turning on. Info: After 45 minutes, the controller switches off again automatically.
Left (MENU)	If one is in the main display then pressing on the left button (MENU) will switch to the menu. This means that the first menu item is displayed. Pressing briefly switches to the next menu item. In editing mode, the number displayed increases or the next available option is displayed.
Right (SELECT)	Pressing briefly saves a current value or confirms a command. If the controller is not in a menu then pressing the right button results in various display information being displayed (see chapter 6.23). Pressing again switches to the next display. Any error message can be acknowledged or rejected by pressing the right button (see chapter 6.24)

6.6 The main display ●●●

The controller is equipped with a large display, which presents all of the requisite information for the diver in a clear and comprehensible format.



The display is divided into 3 rows. The "Top Row" shows depth, time and deco stops. The "Center Row" shows the PPO2 and the "Bottom Row" the current mode, gas and deco Info. The "Bottom Row" is also used to show additional information (6.23 Info Screens). The critical information contained on the Top and Center Rows is always available during a dive.

The data or information displayed in this example comprises:

- The current depth of 39.7 metres. If a **red** flashing "0" is displayed in place of the current depth then the pressure sensor is defective or requires a service.
- An ascending speed of 6 metres per minutes. A maximum of 6 blocks are shown and each block displayed stands for an ascending speed of 3 metres per minute:

	3 metres per minute		12 metres per minute
	6 metres per minute		15 metres per minute
	9 metres per minute		18 metres per minute With more than 18m/min the entire block will flash red.

- The running progress bar beneath "TIME" is a second counter. 60 seconds are shown. Each letter of the word "TIME" corresponds with approx. 15 seconds.

	15 seconds
	30 seconds
	45 seconds
	60 seconds

- A battery warning – The default behavior is that the battery icon is shown at the surface but disappears when diving. If low or critical then the battery icon will appear while diving.

	Battery "OK"
	The yellow battery warning appears if the battery voltage falls below 3.28V for 30 seconds (SAFT 14500). The battery should be replaced as quickly as possible.
	The battery warning flashes red , if the voltage is below 3.15V. If the battery voltage drops to less than 3.2V for 30 seconds (SAFT 14500) then an additional "LOW BATTERY INT" error warning appears in the display. In this case the battery voltage is extremely low and the battery must be replaced immediately!

- Decompression stop at 24 metres for 1 minute

	The next decompression stop is at 24 metres for 1 minute.
	If the diver rises above this depth then the two digits flash in red .
	The decompression is cleared and the diver can ascend to the surface
	Shows the hours and minutes since the end of your last dive. Above 4 days, the surface interval is displayed in days.

Note: The last decompression stop can be set to either 3 or 6 metres.

- The "Center Row" shows the current PPO2 measurement values from the oxygen sensors.

	The controller constantly displays the current PPO2 measurement values from the three oxygen sensors. A deselected sensor is displayed in yellow and is not taken into account in the calculation of the average PPO2. PPO2 values below 0.4 or above 1.6 flash in red .

DEPTH	TIME	STOP	TIME
39.7	30	24	1
1.31	1.29	1.32	
O2/HE	NDL	TTS	
CC 15/50	0	15	

- The next section is the “Bottom Row”.
- The controller is in the closed mode.

	This indicates that the controller is in the closed mode.
	This indicates that the controller is in the open circuit (BO) bailout mode. This information is displayed in yellow because the controller is usually in the closed mode.

- The current gas is a trimix 15/50 (15 % oxygen, 50 % helium).

	The current gas is usually displayed in white.
	If another gas is programmed in the respective mode (CC or BO), which should usually be used at the current depth then the active gas will flash in yellow . This indicates that the user should either remove the other gas from the gas list or switch to the better gas.
	The gas will display in flashing red when its PPO2 is outside of a safe breathing range (i.e. below the min PPO2 or above the max PPO2 setting). In CC mode, this warning refers to the diluent only. The breathing loop PPO2 may be in a safe range, but if the diluent is unsafe to breathe directly then the gas will be red. Note that other warnings exist to warn when the breathing loop is outside of a safe range.

- The No Decompression Limit (NDL) is 0 minutes because it is already necessary to decompress.

	The remaining NDL is 20 minutes.
	If the remaining NDL is less than 5 minutes then this is indicated in yellow .

- The TTS (Total Time to Surface) is 15 minutes.

	The time-to-surface in minutes. This is the current time to ascend to the surface including the ascent plus all required deco stops. Assumes: <ul style="list-style-type: none"> • Ascent rate of 10 metres per minute. • Decompression stops will be followed. • Programmed gases will be used as appropriate.
--	--

Starting from the main screen, the SELECT (right) button steps through the info screens. Info screens provide additional information that does not fit on the main screen. A detailed description can be found in chapter 6.23.

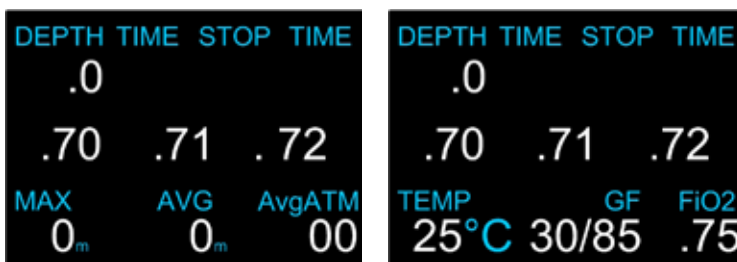

6.7 Compass



The controller has a built-in tilt-compensated compass. When enabled, the compass is viewed by pressing the SELECT (right) button once. Press SELECT again to continue on to view the regular info screens.

Unlike the regular info screens, the compass never times out back to the main screen. When viewing the compass, a MENU (left) button press brings up an "Exit Mark" menu. Right press marks the compass, Left press exits to the main screen.

- The compass is only available on controllers with the hardware version 3.4.0 or higher.

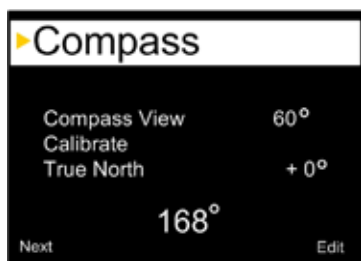

Compass features:

- 1° resolution
- $\pm 5^\circ$ accuracy
- Smooth, high-speed refresh rate
- User set heading marker with reciprocal
- True North (declination) adjustment
- Tilt compensation $\pm 45^\circ$

It is important to understand some compass limitations before use.

- The digital compass needs occasional calibration. This can be done in the System Setup Compass menu and takes only one minute.
- When the battery is changed, the compass should be calibrated. This is because each battery has its own magnetic signature, mostly due to its steel case that interacts with the compass. Fortunately, this effect can be removed with proper calibration.
- Since a compass operates by reading the Earth's magnetic field, the compass heading is affected by anything that distorts that field or creates its own. Ferromagnetic materials (such as iron, steel, or nickel) should be kept away from the controller when using the compass. A traditional compass should also not be placed too close, as it contains a permanent magnet. Electric motors and high-current cabling (such as from dive lights) can also cause interference and should be kept at a distance.

6.7.1 Mark Heading (Compass)

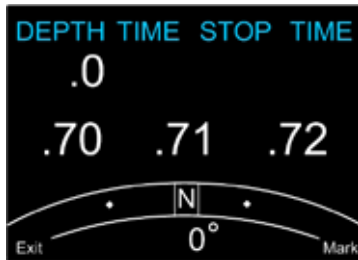
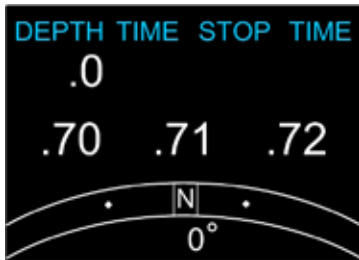

When viewing compass a MENU (left) button press brings up an "Exit Mark" menu. Right press marks compass, Left press exits to main screen.

The heading is shown as:

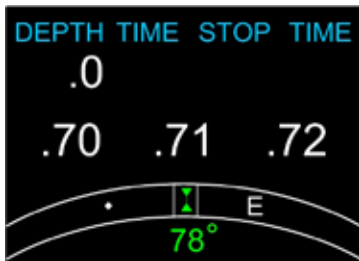

- Only one heading can be marked at a time, it can however be changed. Once a heading has been marked, there is no way to clear the heading arrows from the display.



When a heading is marked, the display shows the offset angle between the current heading and the marked heading. This is useful for navigating patterns. For example, a box pattern requires turns at 90° intervals, while a triangle pattern requires turns at 120° intervals.

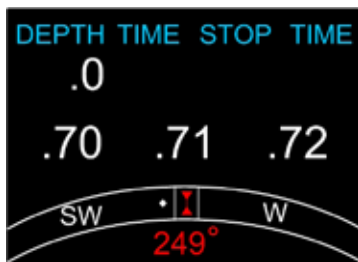

When facing the opposite direction, the reciprocal heading is shown in red.

6.8 Menu structure

The controller is equipped with adaptive menu guidance. This means that unnecessary menus are automatically hidden in the respective mode. The controller also distinguishes between the display of the menu item in diving mode or above water. As such, the two menu items "Turn Off" and "Calibrate" are unavailable when in diving mode.

When the user is in a menu, the controller continues to function in the background. This means for example that the values of the oxygen sensors are read out on a permanent basis, and the controller maintains the selected setpoint. Likewise, calculation of the decompression takes place constantly. If the user is in a menu and does not press either of the two buttons for an extended period then the controller will exit this menu and return to the main display. Settings that have been changed during this period are saved. Everything that has not been definitively confirmed upon returning to the main display is rejected and the original values are retained. The following diagram shows the complete controller menu structure:

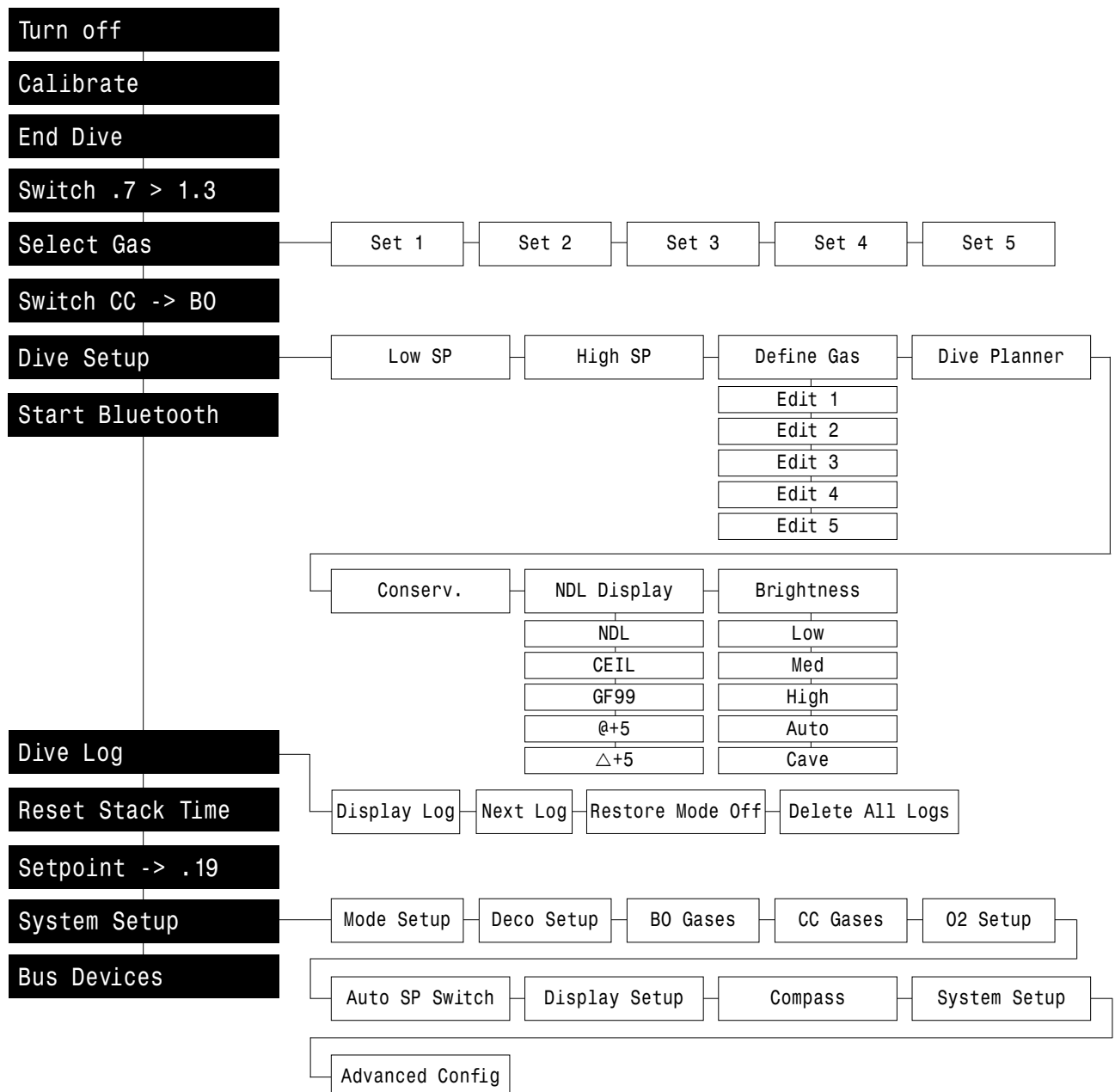

In diving mode the menu structure is further reduced because only those menu items are displayed, which can be adjusted during the dive. Alongside "Turn Off" and "Calibrate", the complete "System Setup" incl. all submenus is also hidden when in dive mode. The following diagram shows the complete menu structure when in dive mode:

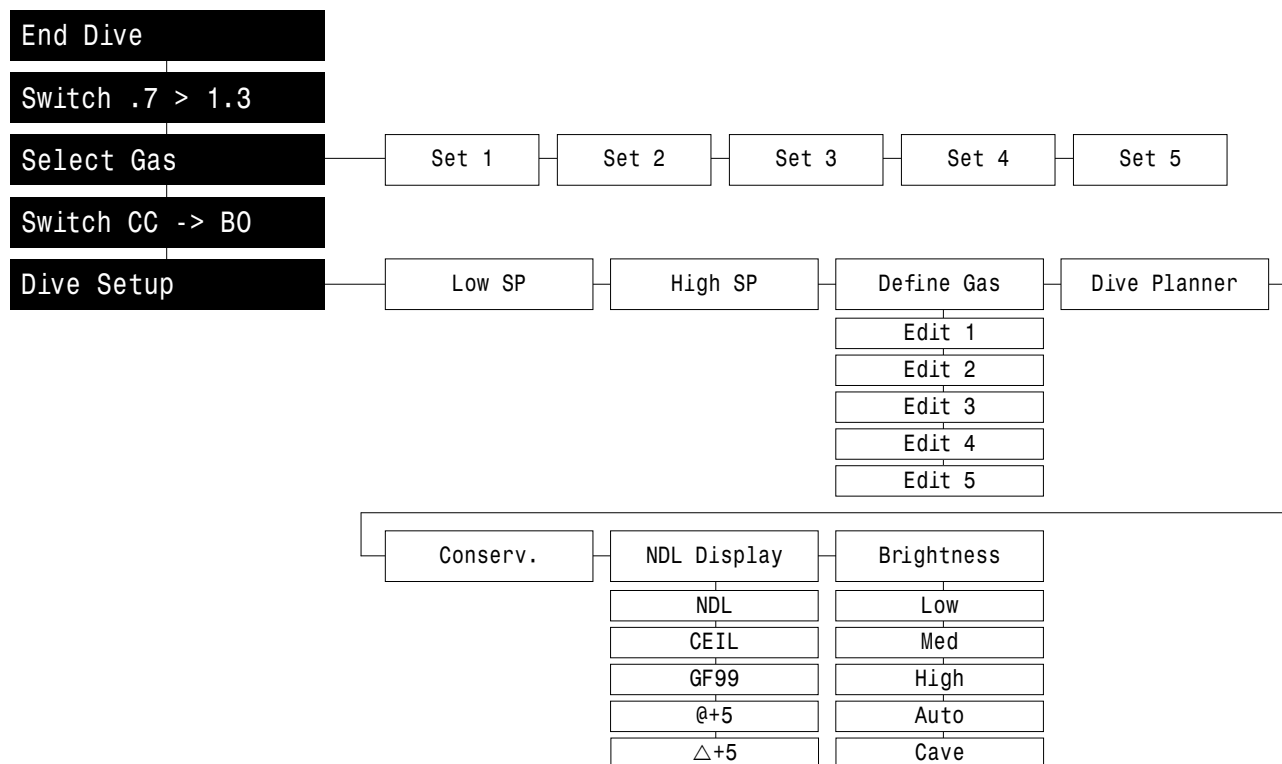

6.9 Menu reference ● ● ●

In this chapter all controller menu items are listed individually and explained.

6.10 Turn Off ● ● ●

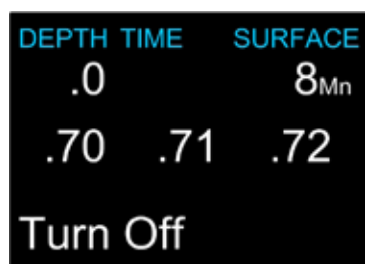

The controller is turned off using this menu item. Turned off is really the wrong term because the controller is essentially put into standby mode, in which it uses very little power. In the background the tissue saturation is still being calculated for example (catchword: Repetitive dives). Likewise, the time and date are naturally also updated. In order to switch on the controller the user must press both buttons at the same time. As soon as the background lighting switches on the user can release the buttons.

- In dive mode this menu item is **NOT** displayed!
- During the first 2 minutes after diving, the controller maintains surface interval and it cannot be turned off at this time.

6.11 Calibrate (calibration of the O2 sensors)

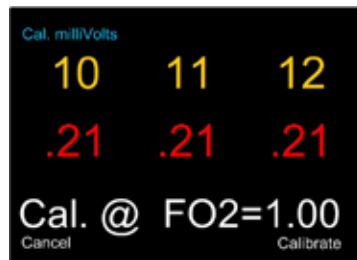
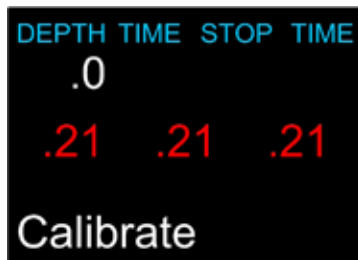

The O2 sensors are calibrated with oxygen via this menu item. The controller for the JJ-CCR Rebreather has a calibration sequence that runs automatically.

- In order to calibrate and dive at altitude it is necessary to set the "Altitude" option to "Auto" in the "Display setup" menu. Only then is the current ambient pressure taken into account in the calibration.
- When surface pressure is less than 960 millibar, the controller forces the use of auto altitude setting (i.e. cannot use the Sealvl setting).
- PPO2 calibration cannot be performed when pressure is above 1080 mbar.
- PPO2 values below 0.4 flash in **red**. If the sensor millivolts are outside an acceptable range then they are shown in **yellow**. Acceptable at 1013 mBar and 98% O2 is a range of 30mV to 70mV.
- Important: The calibration gas must be set to 100% oxygen (see system setup – option "Calibrate O2")
- In countries in which 100% oxygen is not available it is naturally necessary to use the respective oxygen content.
- The controller does not stipulate the individual steps during calibration! It is therefore very important to precisely adhere to the sequence.
 1. Open the oxygen valve and check the current pressure in the oxygen tank.
 2. Open the mouthpiece (= CC mode).
 3. Select the menu item "Calibrate". Check that the calibration gas displayed is 100% oxygen (=CAL @ FO2 = 100).
 4. Pressing the right button (YES) results in the calibration process starting.
 5. The solenoid now allows oxygen to flow into the circuit until the sensor millivolts stabilise and no longer change. This may take some time. Please be patient. During calibration, the PPO2 and MV for every O2 sensor is displayed and the countdown bar at the bottom of the display goes down.
 6. Calibration has been successfully completed as soon as the controller shows the "O2 Cal. Report" on the display. With the status "SUCCESS" for a successfully calibration or "**FAILED**" when the calibration was not successfully.
 7. After confirming the "O2 Cal. Report" it switches back to the main display.

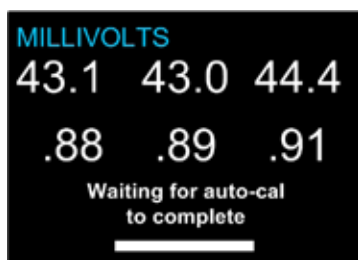

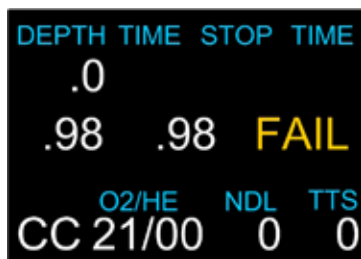

If the O2 sensors are not calibrated or the millivolts are outside the permissible range (35-60 mV), "FAIL" will appear in place of the PPO2 display. This takes place automatically after every software upgrade because the calibration values are overwritten during an upgrade.

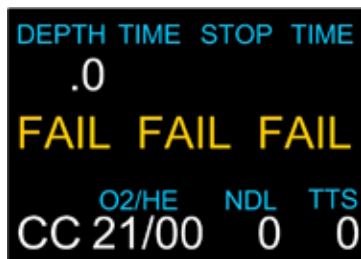

Calibration also takes account of the current height above sea level. If, for example, the ambient pressure is 885 mBar with .87 ATA and the calibration gas is 98% oxygen then a PPO2 of 0.85 will be displayed following calibration!

It is possible that "FAIL" may be displayed against all three sensors. This is the case if the calibration gas in the "O2 Setup" menu has changed. If the PPO2 of the calibration gas changes then the current calibration immediately becomes invalid and "FAIL" is displayed against all three sensors. The same display is also possible if the calibration is erroneously carried out in air. The PPO2 values are only displayed once again after successful calibration.

- In dive mode the menu item "Calibrate" is NOT displayed!
- The oxygen sensors should be calibrated regularly. This should ideally take place prior to every dive and at least once daily with multiple dives.

6.11.1 PPO2 monitoring ●●●

When calculating decompression, the average PPO2 value is used after selection of all three sensors. This process is commonly known as "Voting Logic". The actual value used is displayed with the info screen (AvgPPO2). This is the case as long as no sensor has been switched off, i.e. deselected. A deselected sensor is displayed in yellow and starts to flash. In this case, the average PPO2 of the two remaining sensors is used for calculating the decompression. PPO2 values below 0.4 or above 1.6 flash in red.



If the controller is switched to BO it uses the PPO2 of the active gas at the momentary depth in order to calculate the decompression.

6.11.2 Checking calibration during a dive ●●●

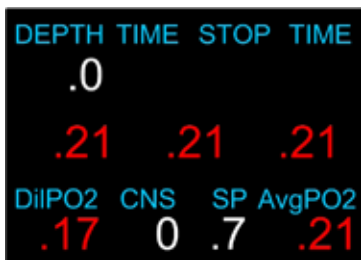

It is a wise precautionary measure to check the correct functionality of the oxygen sensors from time to time during a dive. It is first necessary to flush the diluent from the circuit (= diluent flush). Then press the right button once in order to display the PPO2 of the diluent at the current depth. If the circuit has been correctly and fully flushed with the diluent then the oxygen sensors must display the same PPO2 value. If this is not the case then the diver should immediately bailout.

Another test through which to ascertain whether the oxygen sensors are functioning correctly is to flush the circuit at 6 metres with oxygen (= oxygen flush). The PPO2 should lie above 1.5 after this. If this is not the case, the oxygen sensors should be replaced.

6.12 End Dive ●●●

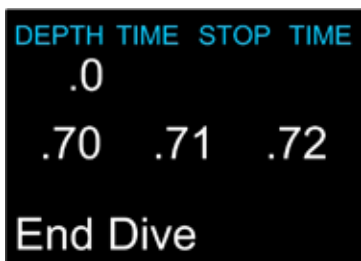

Within the "Advanced Config" menu you can specify for how long the controller will stay in the dive mode after surfacing. Another descend during this time will count as one dive in the internal dive log. With the option "End Dive" the diver can end the current dive and another descend will be added as a second dive in the internal logbook.

- The option "End Dive" is only available when the controller is still in dive mode and when the diver is on the surface.

6.13 Switch Setpoint ●●●

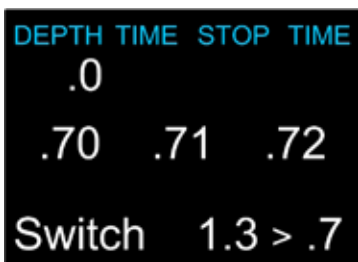
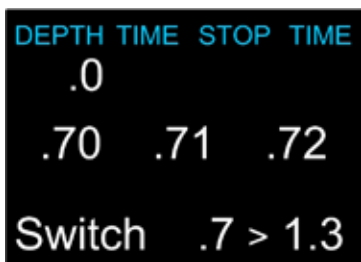

Using this menu item it is possible to change the controller setpoint. In the "Dive Setup" menu (refer to chapters 6.16.1 and 6.16.2) it is possible to define the two setpoints (low and high). In the example, a low setpoint of .7 and a high setpoint of 1.3 are defined.

- In dive mode, when you are not at the surface, this is the first menu item because "Turn Off" and "Calibrate" are both automatically hidden in dive mode.

6.14 Select Gas

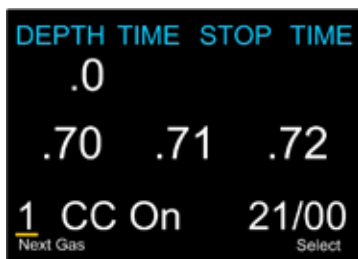
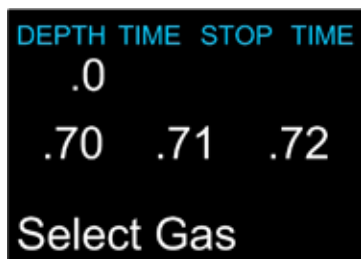

Using the menu item it is possible to select one of the predefined gases. The selected gas is used as a diluent in closed mode (CC) and as a breathing gas in open circuit (BO) bailout mode.

- The selectable gases are sorted from highest to lowest oxygen content! If two gases have the same oxygen content then the gas with the lower helium content is brought to the front of the sequence.
- With a gas change the diver receives no gas recommendation. The diver must personally select the desired gas from the list of available gases.
- If an alternative gas to the set gas is available then the active gas starts to flash **yellow** in the main menu. The display thereby indicates switching to the other gas or removing it from the list of gases if it is not to be used.

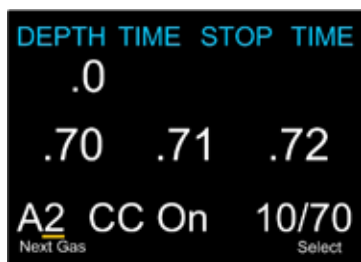

If "Select Gas" is displayed then it is necessary to press the right "Select" button, in order that the first available gas is displayed. Pressing the left "Next Gas" button multiple times results in all available gases being displayed, one after the other. Once all available gases have been displayed the "Select Gas" menu appears once again without the current selection having actually changed. The current active gas is displayed with an "A" before the number.

Once the desired gas is displayed it can be selected by pressing the right button (Select). The controller switches automatically to the main display and the current gas is now shown in the footer. The JJ-CCR controller enables the definition of 5 different gases in closed circuit (CC) and open circuit (BO) bailout mode respectively. The gases can be entirely different and only those gases applicable to the actual active mode are displayed. This means that only the maximum 5 gases for open circuit bailout are displayed when in BO mode, and likewise only the maximum 5 gases for CC mode are displayed when in CC mode. The separation of the two gas lists enables a simple open circuit (BO) bailout: The diver dives with the JJ-CCR Rebreather and has various stages throughout, at which he can switch to this in the event of a rebreather failure. In CC mode he defines his diluent and in open circuit (BO) bailout mode he defines all gases that he has as additional stages. If, during the dive, there is a problem with the rebreather and the diver is required to switch to stages, he simply switches the controller from closed circuit (CC) mode to open circuit (BO) bailout mode. Because all gases are already defined, the decompression and TTS are appropriately adjusted and he is able to continue diving safely without needing to make any further setting adjustments on the controller.

6.15 Switch CC/BO (Between Closed and Open Circuit Bailout Mode) ●●●

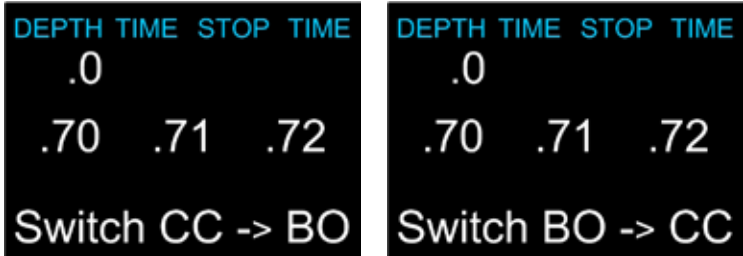

Using this menu item it is possible to switch from the closed mode (CC) to the open circuit (BO) bailout mode. The active mode is displayed first and the arrow indicates the mode into which it is possible to switch. In the first figure the controller is in CC mode and is being switched to BO mode.

In the second figure the controller is in open circuit (BO) mode and is being switched to CC mode. In order to switch it is necessary to press the right button (Select). After this is controller switches automatically to the main display. The footer (CC or BO) indicates which mode the controller is currently operating in.

- When changing to open circuit (BO) bailout mode the controller automatically switches to low setpoint. The display for the bailout mode (BO) is shown in yellow because the controller should usually be in CC mode.
- If the diver switches to open circuit (BO) bailout mode then the gas best suited at that time to being used as a breathing gas is selected and applied for the decompression calculations. The diver is subsequently able to change to an alternative gas at any time, if he does not concur with the selection. To do so he must choose the "Select Gas" menu function.

6.16 Dive Setup ●●●

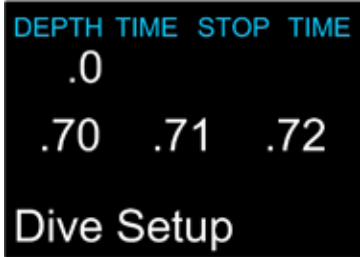

Using this menu item the diver can access various submenus:

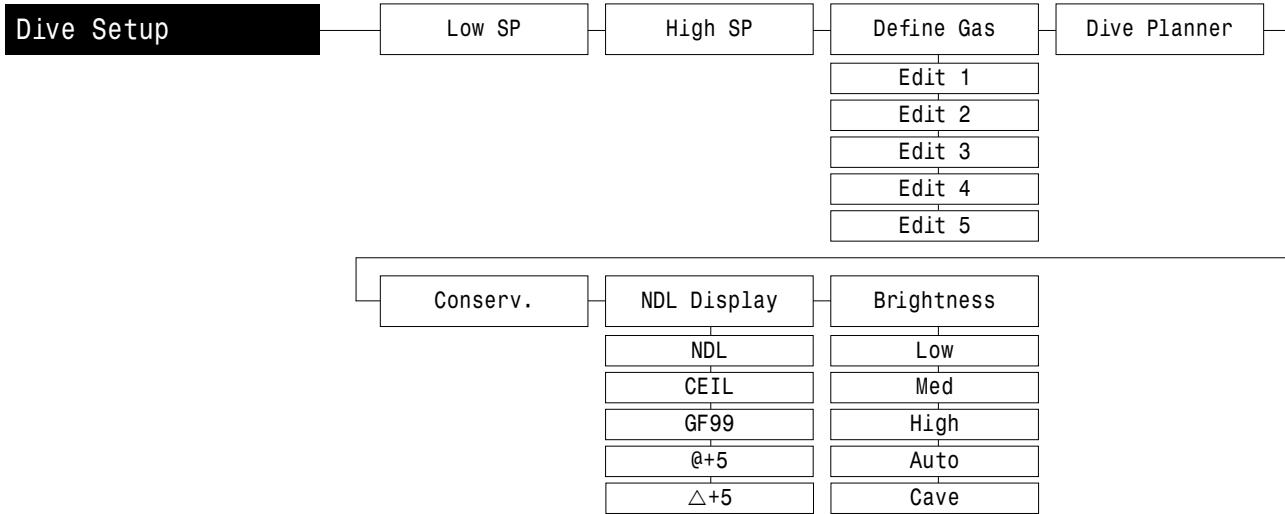

Pressing the right button (Select) once takes the diver to the first submenu. Pressing the left (Menu) button multiple times results in all available submenus being displayed, one after the other. Once all available submenus have been displayed, the "Dive Setup" menu appears once again

6.16.1 Low SP (Low Setpoint) ●●●

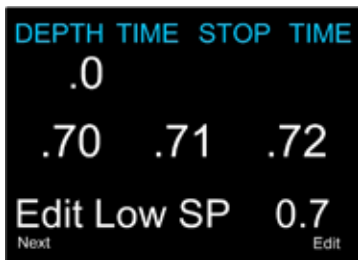

Using this menu item it is possible to set the low setpoint. The low setpoint that is currently set is always displayed. In the figure a low setpoint of .7 (= 0.7) is set.

- Permissible setpoint values are 0.4 to 1.5.

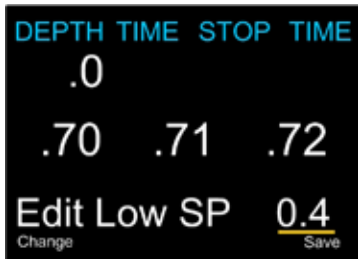

By pressing the right button "Edit" it is possible to set the low setpoint. "Edit Low SP" appears in the footer and the low setpoint is displayed as .4. Pressing the left button "Change" results in the low setpoint being increased in steps of 0.1. This means that the button must be pressed multiple times, until the desired low setpoint is displayed. Once the desired low setpoint is displayed it can be stored by pressing the right "Save" button.

Following this, "Low SP" is once again displayed with the current defined value in the footer.



By pressing once on the left button "Next" the diver is now able to display the next submenu.

6.16.2 High SP (High Setpoint) ●●●

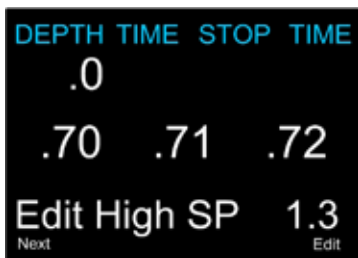

Using this menu item it is possible to set the high setpoint. The high setpoint that is currently set is always displayed. In the figure a high setpoint of 1.3 is set.

- Permissible setpoint values are 0.4 to 1.5.

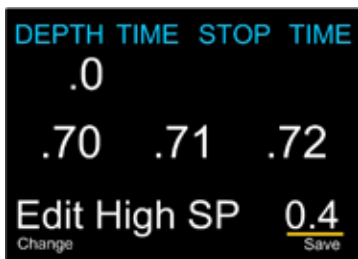

By pressing the right button "Edit" it is possible to set the high setpoint. "Edit High SP" appears in the footer and the high setpoint is displayed as .4. Pressing the left button "Change" results in the high setpoint being increased in steps of 0.1. This means that the button must be pressed multiple times, until the desired high setpoint is displayed. Once the desired high setpoint is displayed it can be stored by pressing the right "Save" button. Following this, "High SP" is once again displayed with the current defined value in the footer.

Following this, "High SP" is once again displayed with the current defined value in the footer.



By pressing once on the left button "Next" the diver is now able to display the next submenu.

6.16.3 Define Gas

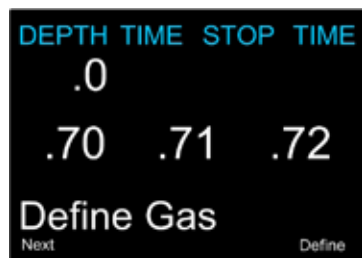

Using this menu item it is possible to set the breathing gases used. The controller allows the diver to set 5 different gases in closed circuit (CC) mode and 5 different gases in open circuit (BO) bailout mode.

In order to set the breathing gases for the open circuit (BO) the controller must be in BO mode, and likewise when setting the gases for the closed circuit (CC) it must be in CC mode.

It is possible to define the percentage oxygen and helium content in each gas.

- The "A" in front of the gas number indicates the active gas. This cannot be deleted, i.e. setting 0% O₂ and 0% helium generates an error message. However, the gas can be adjusted at any time.
- The gases set are used for the projection of the total Time To Surface (TTS). It is therefore essential to define only those gases that are actually available.
- Decompression of the current active gas is correctly calculated.
- All gases with 0% oxygen and 0% helium are automatically hidden in the "Select Gas" menu.
- The gases can also be adjusted underwater.

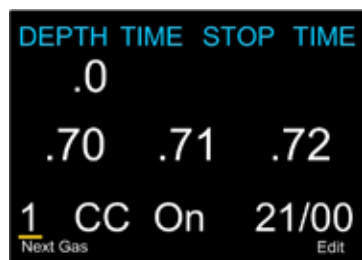

Pressing the left button "Next Gas" results in the next gas being displayed. The gases are numbered from 1 – 5. The sequence in which the gases are input is irrelevant. In the "Select Gas" menu all available gases are always displayed in order according to their O₂ content (from the highest to the lowest). If two gases have the same O₂ content then the gas with the lower helium content is brought to the front of the sequence.

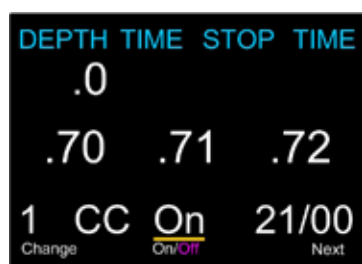

By pressing the right button "Edit" it is possible to edit the gas. First you select whether a gas is active (= On) or not active (= Off). The active gases are used for the projection of the total Time To Surface (TTS) and gas switches. It is therefore essential to define only those gases that are actually available.

After that the O₂ content of the gas is set. Only one digit of the number is changed at a time. The ten's are always set first. Pressing the left button "Change" results in the displayed digit being increased by 1. After the digit has reached 9 it will revert back to 0 again. Pressing the right button (Next) once takes the diver to the units digit.

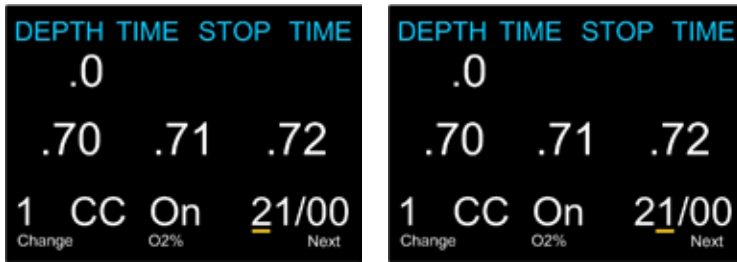

Next, the helium content of the gas is set. Only one digit of the number is changed at a time. The ten's are always set first. Pressing the left button "Change" results in the displayed digit being increased by 1. After the digit has reached 9 it will revert back to 0 again. Pressing the right button (Next) once takes the diver to the units digit.

Upon arriving at the units digit for the helium content it is possible to save the gas data by pressing the right button "Save".

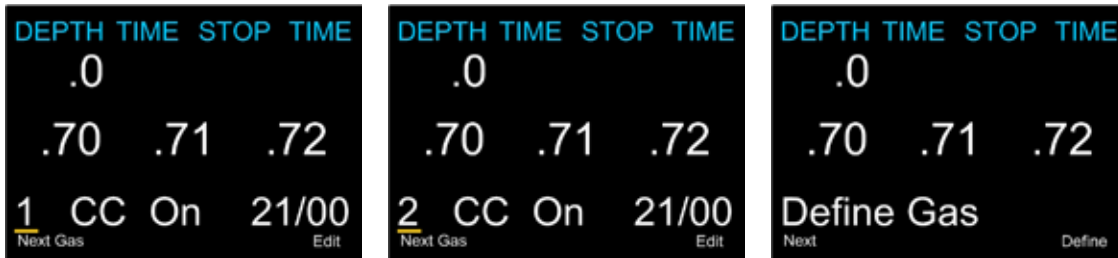

Pressing the left button "Next Gas" switches to the next gas. If the gas number is preceded by an "A" then this is the current active gas. It is possible to adjust this but not to delete it (0% O2 and 0% HE).

If all 5 gases have been displayed then the user automatically arrives back at the menu item "Define Gas".

6.16.4 Dive Planner

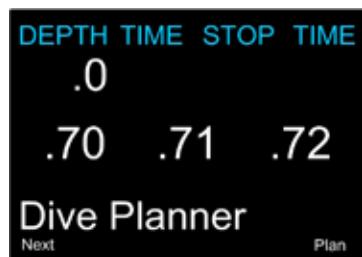

The dive planner facilitates the calculation of decompression profiles for simple dives. Two different modes are available here:

Mode	Description
Surface Mode	In the surface mode the user is able to plan a dive on the basis of the parameters entered. The current CNS load is taken into account during the calculation.
Dive Mode	In dive mode the decompression profile is calculated based on the current situation.

When calculating the decompression profile all gases input and the defined low and high gradient factors are taken into account. Additionally, the profile for the respective active mode closed circuit (CC) or open circuit (BO) bailout is generated.

The dive planner is only intended for planning simple dives. Multi-level dives are therefore not supported. Furthermore, the following assumptions are applied to the calculation:

- Descent rate is 18m/min and the ascent rate is 10m/min.
- For open circuit (BO) bailout mode, the gas in use will be the gas with the highest PPO₂ less than 1.40 for the bottom gas and 1.61 for deco gases. The deco gas max PPO₂ can be changed in the "ADV Config 1" menu.
- For closed circuit (CC) mode, the gas in use will be the gas with the highest PPO₂ less than 1.05.
- The planner will use the configured last stop depth.
- For closed circuit (CC) mode, the PPO₂ is constant for the entire dive.
- The RMV is the same while diving as during deco.
- The Dive Planner does not provide thorough validation of the profile. For example, it does not check for nitrogen narcosis limitations, gas usage limitations, CNS percentage violations, or isobaric counter-diffusion risks due to sudden helium switches. The user is responsible for ensuring a safe profile is followed.

The following figures show the dive planner in surface mode.



The first figure shows the dive planner in open circuit (BO) bailout mode and the second shows it in closed circuit (CC) mode. In closed circuit (CC) mode it is additionally possible to define the PO2.

First set the depth. Only one digit of the number is changed at a time. The hundred's are always changed first. Pressing the left button "Change" results in the displayed digit being increased by 1. After the digit has reached 9 it will revert back to 0 again. Pressing the right button (Next) results in a jump to the next digit. The respective maximum and minimum values are shown in the display.



The desired bottom time in minutes is set in the same manner.

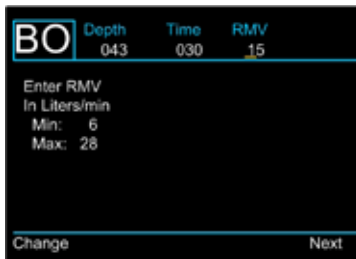

Following this, the respiratory minute volume (RMV) is set in litres.

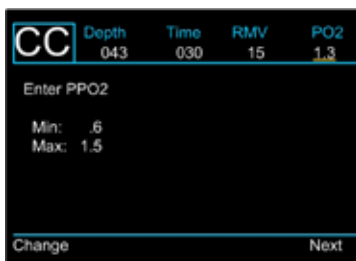

In closed circuit (CC) mode it is additionally possible to define the PPO2.

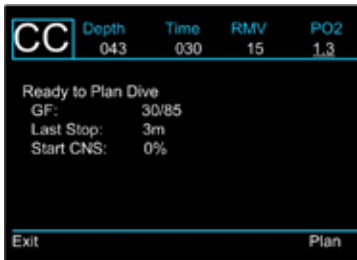

Once all parameters have been defined, the dive planner displays the set gradient factors and the current CNS loading. It is also possible to use the dive planner for the calculation of repetitive dives because the current CNS loading can be taken into account. By pressing the left button "Quit" the user exits the dive planner, whilst pressing the right button "Plan Dive" results in the calculation starting.

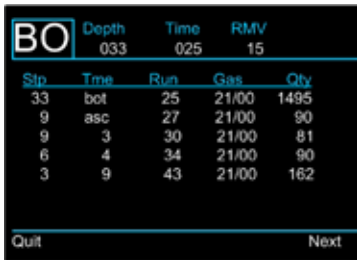

Display	Description
Stp	Stop Depth in metres
Tme	Stop Time in minutes
Run	Run Time in minutes
Gas	Indicates the breathable gas. The Dive Planner takes into account all gases entered!
Qty	Indicates the gas quantity in litres. This info is only displayed in the OC or BO plan. The CC plan does not display this information!
Bot	Bottom Time
Asc	Ascent Time

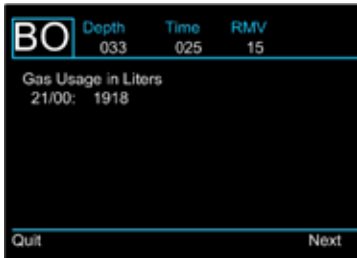

If there is insufficient space for the complete plan on one display screen, the user accesses the next screen by pressing the right button "Next".

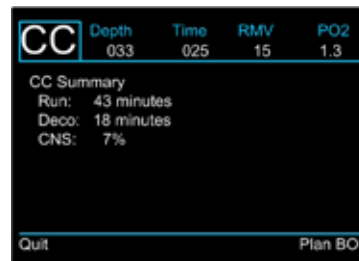
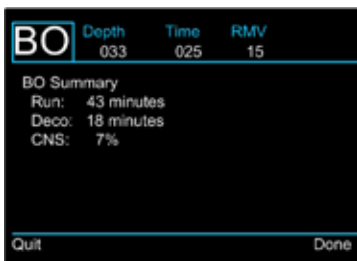

Once the complete decompression plan has been displayed, pressing the right button "Next" generates a summary of the gas consumption in the display (only in the open circuit (BO) plan!). The dive planner calculates the gas consumption of all gases entered!

In closed circuit (CC) mode it is possible to press the right button "Plan BO" when viewing the summary in order to start the calculation of a bailout plan. The bailout plan is generated in open circuit (BO) bailout mode and takes into account all BO gases entered. The bailout plan is generated for the end of the bottom time entered. If, for example, the bottom time is set at 25 minutes at a certain depth, the bailout plan calculates the decompression profile in open circuit (BO) bailout mode after 25 minutes has passed. Because the dive planner is located in the dive menu, it is also possible to use it underwater, i.e. in dive mode. It is not possible to adjust any settings in dive mode; instead the decompression profile is always calculated on the basis of the current situation. If required it is possible to have a detailed decompression plan displayed in place of information pertaining to TTS, decompression stop and time on the main display. As previously described, this contains all decompression stops including time, gas change and - in open circuit (BO) bailout mode - even the gas consumption. In closed circuit (CC) mode the gas consumption is not included in the list. It is therefore not possible to display an open circuit bailout plan. The open circuit bailout plan also assumes the current situation in dive mode. As such it is possible to check the decompression profile format at any time, if one is required to switch immediately to open circuit.

6.16.5 Conserv.

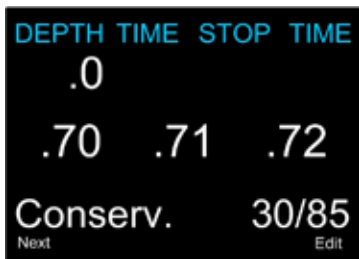

Using this menu item it is possible to set the conservatism for the calculation of the decompression based on gradient factors (low and high). Two different modes are available here:

Mode	Description
Surface Mode	In surface mode the user is able to set both gradient factors (low and high).
Dive Mode	In dive mode the user is only able to set the high gradients.

- These settings can have a massive effect on the decompression calculations of the controller!
- If the diver does not know what effects these settings will have, no setting adjustments should be made for safety reasons!
- In order to understand the settings the diver must be aware of the theory of the gradient factors, M-values, inert gas pressure, etc!

A range of articles on this subject can be found on the internet. The article by Eric C. Baker can be recommended in particular.

If the settings are to be changed (edit mode) then it is necessary to push the right button "Edit".



First the low gradient factor is set (visible at the "GF Lo" display). Only one digit of the number is changed at a time. The ten's are always set first. Pressing the left button "Change" results in the displayed digit being increased by 1. After the digit has reached 9 it will revert back to 0 again. Pressing the right button "Next" once takes the diver to the units digit.



Now the high gradient factor is set (visible at the "GF Hi" display). Only one digit of the number is changed at a time. The ten's are always set first. Pressing the left button "Change" results in the displayed digit being increased by 1. After the digit has reached 9 it will revert back to 0 again. Pressing the right button "Next" once takes the diver to the units digit.

Pressing the right button "Save" saves the current settings. Editing mode is closed and the user switches to the next menu item.

6.16.6 NDL Display (GF99, CEIL, NDL, @+5 or Δ+5 display)

Using this menu item it is possible to set five different displays (NDL, CEIL, GF99, @+5 and Δ+5) for the decompression. It is also possible to change these displays during the dive.

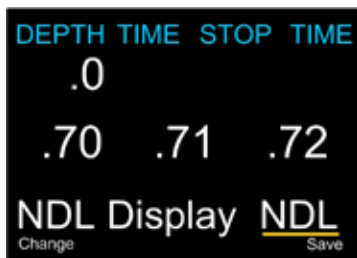

By pressing the right button "Edit" the user accesses the edit mode (second screen). Pressing the left button "Change" multiple times result in the individual modes being selected. Once the correct mode has been located, this is selected by pressing the right button "Save", after which the edit mode is exited.

Option	Description
NDL	NDL (No Decompression Limit). The NDL will always be displayed during the dive whether or not you have a decompression ceiling.
CEIL	<p>The next selection is CEIL. With this setting, as long as the NDL time is 0 (you have a decompression ceiling), the raw ceiling will be displayed instead of the NDL. This is the equivalent of the "Man on a rope". It will show your ceiling without it being rounded up to the next even 3 metres stop. Please note that there is very limited information on the effects of following a continuous ceiling instead of stopping at stops and only moving up to the next stop when the stop has cleared.</p> <p>It is the controller manufacturer's opinion that all stops should be honored. It seems intuitive that if you have bubbles, and you stop, you give the bubbles an opportunity to be resorbed. If you continuously ascend, the ambient pressure is continuously reduced which prevents bubbles from shrinking. Because of this belief, the computer will give one MISSED DECO STOP message during the dive and one after the dive, and will flash the stop depth and time in red as long as you are above the stop depth. It will use the increased gradient though, and your calculated off-gassing will be faster than staying at the stops.</p>
+@5	<p>The selection „@+5" is the time to surface (TTS), if you were stay at the current depth for five more minutes. This can be used as a measure of how much you are on-gassing or off-gassing.</p> <p>For example, on a dive on a wreck, you go to the bottom until you accumulate the desired decompression and TTS. After ascending to the second deck, you notice that the @+5 and TTS are the same. That means that you can spend 5 minutes exploring this deck without incurring more decompression.</p> <p>Once you get to the top deck, the current has picked up. The line runs from the top of the deck to the surface which is a distance of 10 m. You see that your @+5 is 11 minutes and your TTS is 15 minutes. That means that you can stay down out of the current for 5 minutes and burn off about 4 minutes of deco. You may decide to accept the 80% decompression efficiency and stay out of the current.</p> <p>When your TTS is 10 minutes, you see that your @+5 is 9 minutes. Since the decompression is not very efficient now, you go up the line and spend the last 10 minutes in the current.</p>
Δ+5	<p>Δ+5 is the difference in the time-to-surface (TTS) if you remain at the current depth for 5 more minutes. This value can be positive or negative. For example, a Δ+5 of +10 would mean that staying 5 more minutes at the current depth would result in 10 more minutes of decompression stops.</p> <p>Δ+5 is similar to @+5, but the @+5 value shows the entire TTS while the Δ+5 only shows the difference from the current TTS.</p>

GF99	<p>This option is to display the actual supersaturation gradient for a pure Bühlmann (99/99) profile.</p> <p>With this setting, as long as the NDL time is 0 (you have a decompression ceiling), the gradient will be displayed instead of the NDL. The number shown is the percentage of supersaturation. The number is calculated by reference to the Ambient Pressure Line and the M-Value line. It can be thought of as the current GF, but it is different in a couple of ways. First, the current GF generates stops rounded to the nearest 3 metres. So a gradient of 40 may reflect a ceiling of 4.5 metres, but the computer will show a rounded up 6 metres stop.</p> <p>This number can be used in several ways. First, it can be used to calculate an aggressive ascent that still has some justification in decompression science. For example, if a diver were to lose a significant portion of their gas and needed to get shallow fast, they could ascend until they reached a gradient of 90, then stop until it dropped to 80, then ascend to 90 again, etc. that would produce a Bühlmann-like profile with very little conservatism. In an emergency, that may be an acceptable risk.</p> <p>Another use might be to do a slower ascent on a dive to sightsee, but to stay in the decompression zone by keeping the gradient above 0.</p> <p>Another use would be to observe the rapidly increasing gradient in the last 3 metres to the surface and slow that ascent.</p>
-------------	--

The controller manufacturer has issued the following remarks:

All of this is based on gradient theory that may be completely false. There is significant disagreement in the decompression research community about the nature and practice of decompression. Any techniques described here should be considered experimental, but the concepts may be useful to the advanced diver.

6.16.7 Brightness

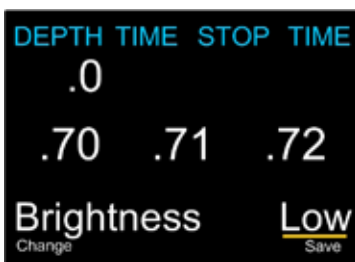
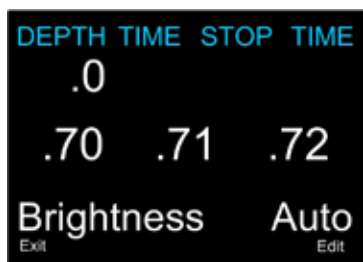

Using this menu item it is possible to set the brightness of the display. Pressing the right button "Edit" switches the mode. Four different modes are available for selection:

Mode	Description
Auto	The brightness sensor measures the ambient light and automatically adjusts the brightness of the display.
Low	Permanent minimum brightness
Med	Permanent medium brightness
High	Permanent maximum brightness
Cave	Suitable for very dark environments like caves.

- The brightness of the display is the major determinant of battery life. Up to 80% of the power consumption is to power the display. When a low battery alert occurs, the display brightness is automatically reduced to extend battery life.

6.17 Start Bluetooth

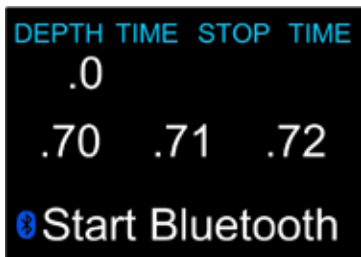

Via this menu item you enable the Bluetooth interface. Bluetooth is used for firmware upgrades and upload the dive logs.

6.18 Dive Log

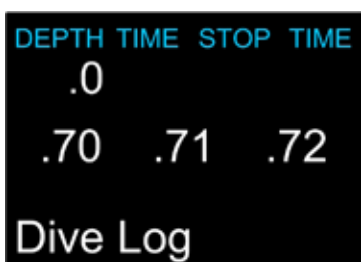

Using this menu item it is possible to access a range of submenus for the controller's dive logbook.

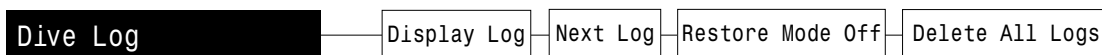

Pressing the right button (Select) once takes the diver to the first submenu. Pressing the left (Menu) button multiple times results in all available submenus being displayed, one after the other. Once all available submenus have been displayed, the "Dive Log" menu appears once again.

6.18.1 Display Log / Edit Log

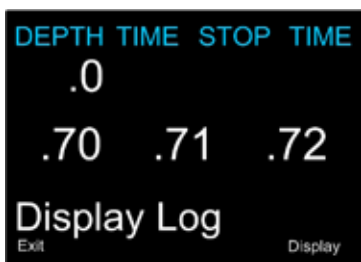

Via this menu item it is possible to display the controller's dive logbook. Pressing the right button "Display" results in the list of saved dive logs.

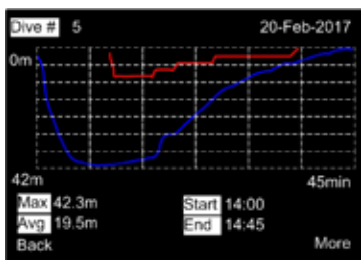

The dive profile is presented in **blue** and the decompression profile is shown in **red**. The following additional information is also shown:

- Dive number
- Duration in minutes
- Date
- Start and end time
- Max. Depth

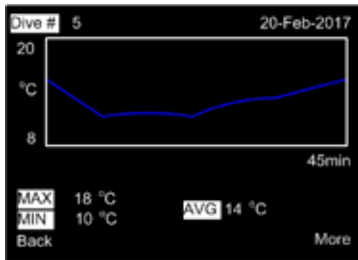

Pressing the right button (More) will show a plot of the dive temperature. It also shows the minimum, maximum and average temperature.

Mode	CC/BO
Surface Int	01h 30m
Surface mbar	1004
Deco Model	GF 30 / 70
Start CNS	008%
End CNS	018%

Pressing the right button (More) again will show additional information about the dive.

Pressing the right button "Edit" allows to edit some dive log parameters or to delete a dive.

- Note that when dives are deleted the data isn't actually deleted, but rather the log is flagged so that it does not display on the controller or desktop software. However, logs can still be undeleted or downloaded with special commands. Reason for the ability to recover logs is in the case of a diving accident, where logs have been accidentally or maliciously deleted.

6.18.2 Display Log / Edit Log ●●●

DEPTH	TIME	STOP TIME
.0		
.70	.71	.72

Next Log = 0035

Using this menu item it is possible to adjust the internal dive number. This is helpful, for example, if the logbook has been deleted and the sequential dive numbering is to be continued where it left off. Or if the user wishes the dive numbers in the logbook to be identical to the number of actual dives.

By pressing the right button "Edit" it is possible to adjust the dive number.

The next dive receives the number defined here. I.e. the entry 0035 will result in the next dive being issued with the number 35.

6.18.3 Restore Mode Off ●●●

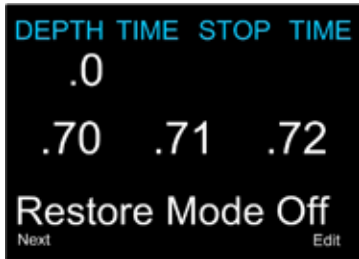

With this menu item it is possible to recover deleted dive logs. Setting this to "ON" allows either a "Restore All Logs" option or restoring individual logs (View the log list, deleted logs will be grayed out. Enter into the log view then the edit page will have an undelete option). After the unit is turned off then back on, this option will be reset to "OFF".

6.18.4 Delete All Logs ●●●

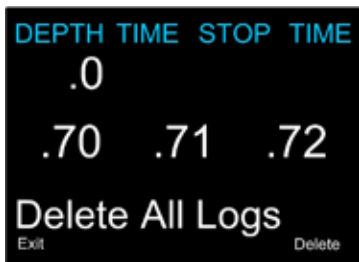

Using this menu item allows to delete all dive logs. After pressing the right button "Delete", a new screen shows up and you will need to confirm this action.

Logs can still be undeleted (Restore Mode) or downloaded with special commands. Reason for the ability to recover logs is in the case of a diving accident, where logs have been accidentally or maliciously deleted.

6.19 Reset Stack Time ●●●

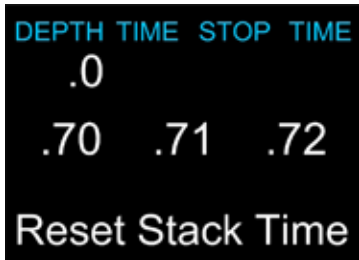

This menu item allows to manually reset the stack time when changing the scrubber stack.

6.20 Setpoint -> .19

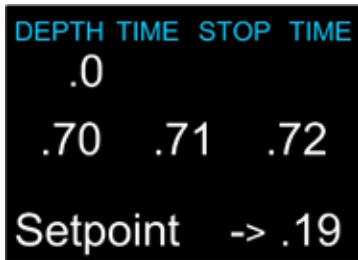

This menu item is only displayed in surface mode. It allows to switch to a setpoint of .19 whilst the controller is on the surface. This prevents the solenoid from being permanently active. The function is mainly used during a firmware upgrade or when uploading dives.

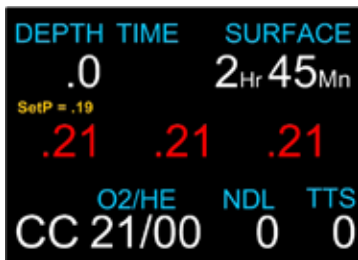

- The 0.19 setpoint is not intended for use when breathing on the loop!
- When setpoint .19 is selected the center row displays a yellow warning "Setp = .19" above the PPO2 readings.
- The solenoid injection is very aggressive when the 0.19 setting is active.

Switching to the normal setpoint takes place in the "Switch SP" menu.

6.21 System Setup

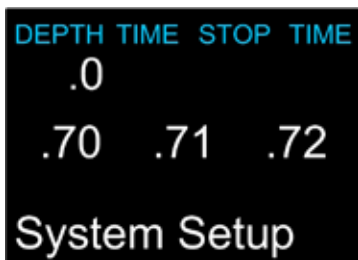

Using this menu item it is possible to access a range of submenus for the basic configuration of the controller. This menu item, as well as all of the submenus contained within it, are unavailable in dive mode. As such, basic configuration of the controller can only be carried out at the surface.

Various options such as "Low and High Setpoint" or "NDL Display" can also be found in the dive menu and can therefore be retrospectively adjusted as necessary when underwater.

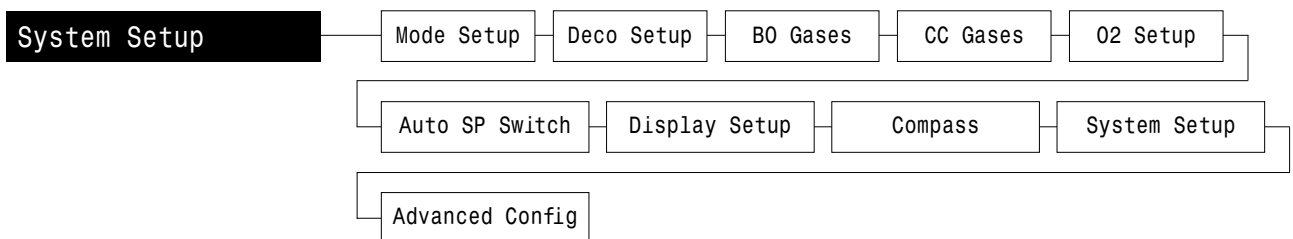

The system setup submenus are grouped into various areas. All of the settings relevant to one area can be viewed on a single screen.

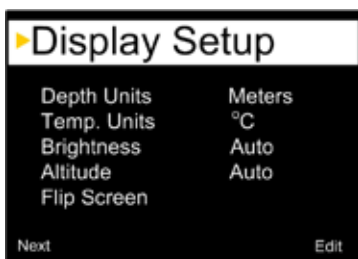

All settings (basic settings, gases used, etc) can therefore be implemented quickly and easily prior to the dive. If necessary, it is also possible to make adjustments underwater via the dive setup menu, as previously described. It is essentially irrelevant whether settings are adjusted in the dive menu or within the system setup submenu! It is always the same values that are changed. If, for example, the diver sets the low SP in the dive setup to 0.8 then this value will also be displayed under low SP in the dive menu. If the diver changes this value back to 0.7 in the dive menu then this value will also be adjusted in the dive setup.

6.21.1 Mode Setup ●●●

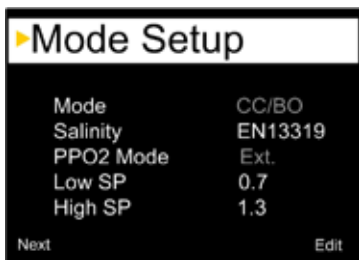

The first submenu of the system setup is "Mode Setup". The options "Low SP" and "High SP" are identical to those in the dive setup menu.

- The options "Mode" and "PPO2 Mode" can't be edited because they are fixed and appear grayed-out.

6.21.2 Salinity (Mode Setup) ●●●

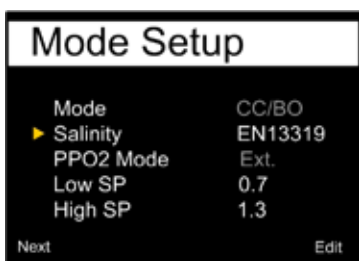

Water type (salinity) affects how the measured pressure is converted to depth.

Setting	Description
EN13319	The EN13319 value is between Fresh and Salt. It is from the European CE standard for dive computers, and is the controller's default value
Fresh	Fresh water
Salt	Salt water

- Fresh and Salt water differ by about 3%. Salt water, being denser, will display a shallower depth for the same measured pressure versus the Fresh water setting.
- The setting only has an impact for the displayed depth. It has no impact on the decompression calculation.

6.21.3 Low Setpoint (Mode Setup) ●●●

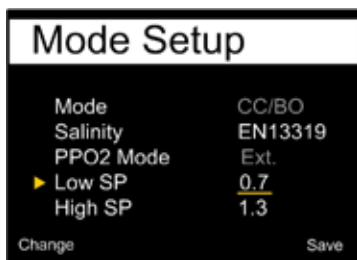
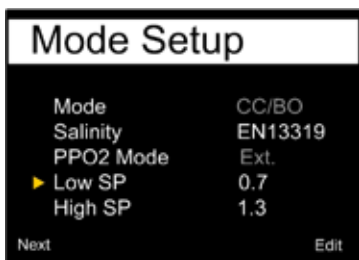

By pressing the right button "Edit" the user accesses the edit mode for the low setpoint. In order to change the value it is necessary to press the left button "Change" until the desired value is displayed (possible values are 0.4 to 1.5). By pressing the right button "Save" the current value is saved and the user switches to the next entry. The current entry is marked with a "▶".

6.21.4 High Setpoint (Mode Setup)

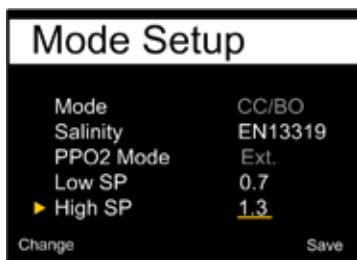
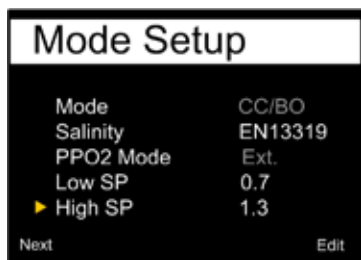

By pressing the right button "Edit" the user accesses the edit mode for the high setpoint. In order to change the value it is necessary to press the left button "Change" until the desired value is displayed (possible values are 0.4 to 1.5). By pressing the right button "Save" the current value is saved and the user switches to the next entry. The current entry is marked with a "▶".

6.21.5 Deco Setup (Overview)

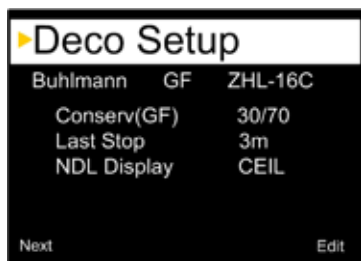

The second submenu of the system setup is "Deco Setup". Here, it is possible to define various parameters for the decompression calculation.

- Within this menu you can also select the decompression algorithm, taking into account that the optional VPM-B / VPM-B/GFS algorithm is enabled. Please refer to chapter 7 for a detailed description.

6.21.6 Conserv. (Deco Setup)

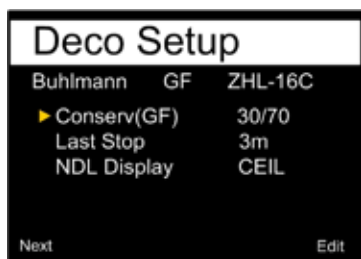

Using this menu item it is possible to set the conservatism for the calculation of the decompression based on gradient factors (low and high).

- These settings can have a massive effect on the decompression calculations of the controller!
- If the diver does not know what effects these settings will have, no setting adjustments should be made for safety reasons!
- In order to understand the settings the diver must be aware of the theory of the gradient factors, M-values, inert gas pressure, etc!

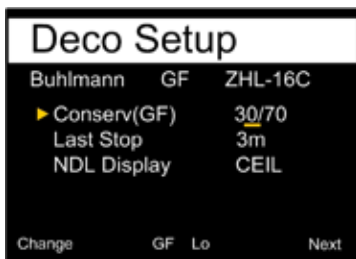
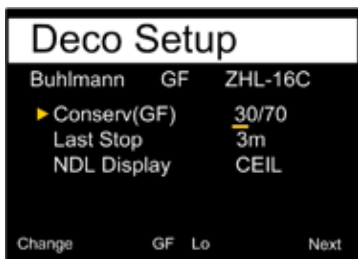

First the low gradient factor is set (visible at the "GF Lo" display). Only one digit of the number is changed at a time. The ten's are always set first. Pressing the left button "Change" results in the displayed digit being increased by 1. After the digit has reached 9 it will revert back to 0 again. Pressing the right button "Next" once takes the diver to the units digit.

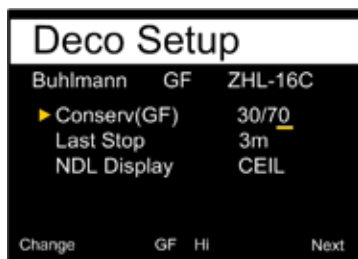
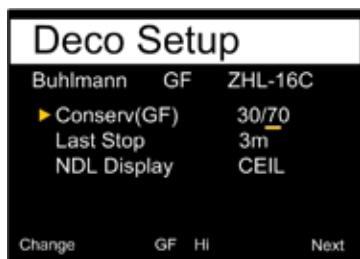

Now the high gradient factor is set (visible at the "GF Hi" display). Only one digit of the number is changed at a time. The ten's are always set first. Pressing the left button "Change" results in the displayed digit being increased by 1. After the digit has reached 9 it will revert back to 0 again. Pressing the right button "Next" once takes the diver to the units digit.

By pressing the right button "Save" the current settings are saved and edit mode is exited, and the user switches to the next entry. The current entry is marked with a "▶".

6.21.7 Last Stop (Deco Setup) ●●●

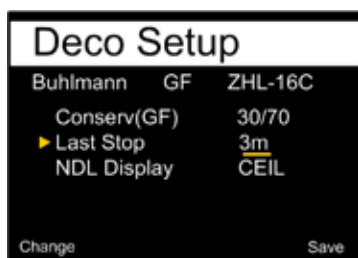
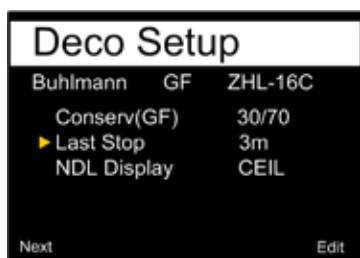

Using this menu item it is possible to define the depth of the last decompression stop. It is possible to set the last decompression stop at either 3 or 6 metres.

By pressing the right button "Edit" the user accesses the edit mode. In order to change the settings it is necessary to press the left button "Change" until the desired option is displayed. By pressing the right button "Save" the current setting is saved and the user switches to the next entry. The current entry is marked with a "▶".

6.21.8 NDL Display (Deco Setup) ●●●

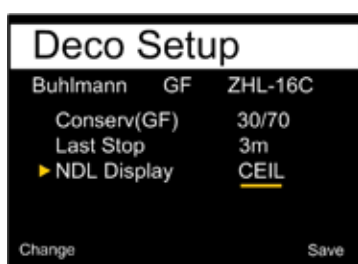
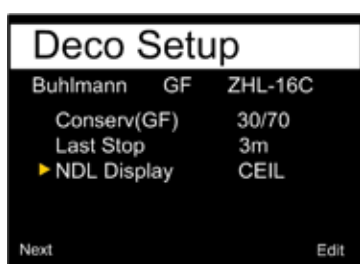

The NDL display options are identical to those in the dive setup menu:

- NDL
- CEIL
- GF 99
- @+5
- **Δ+5**

(See chapter: 6.16.6 for a more precise explanation of the options).

By pressing the right button "Edit" the user accesses the edit mode for the NDL display. In order to change the settings it is necessary to press the left button "Change" until the desired option is displayed. By pressing the right button "Save" the current setting is saved and the user switches to the next entry. The current entry is marked with a "▶".

6.21.9 BO Gases

The third submenu of the system setup is "BO Gases". Using this menu item it is possible to configure all 5 gases for the open circuit (BO) mode. The individual options and configurations are identical to those in the "Define Gas" area, in the dive setup menu. However, all 5 gases are displayed simultaneously here.

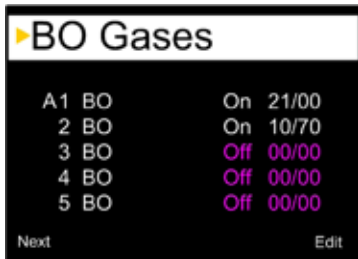

The sequence in which the gases are input is irrelevant. In the "Select Gas" menu all available gases are always displayed in order according to their O2 content (from the highest to the lowest).

- If two gases have the same O2 content then the gas with the lower helium content is brought to the front of the sequence.

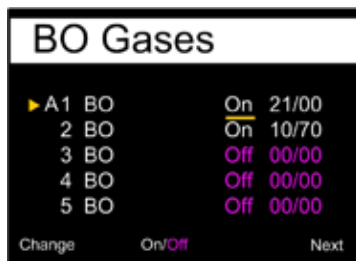
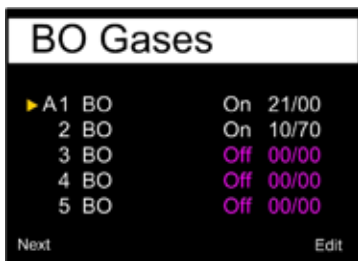

By pressing the right button "Edit" the user accesses the edit mode. The "▶" symbol moves to gas number 1. By pressing the left button "Next", it moves to the next gas number. By pressing the right button "Edit" it is possible to adjust the gas.

First you select whether a gas is active (= On) or not active (= Off). The active gases are used for the projection of the total Time To Surface (TTS) and gas switches. It is therefore essential to define only those gases that are actually available.

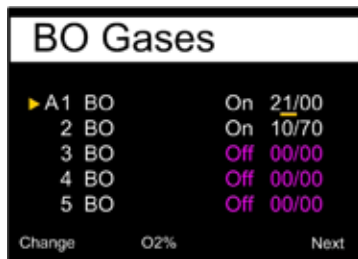
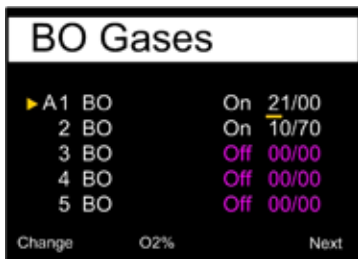

After that the O2 content of the gas is set. Only one digit of the number is changed at a time. The ten's are always set first. Pressing the left button "Change" results in the displayed digit being increased by 1. After the digit has reached 9 it will revert back to 0 again. Pressing the right button (Next) once takes the diver to the units digit.

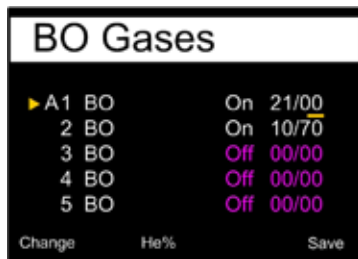

Next, the helium content of the gas is set. Only one digit of the number is changed at a time. The ten's are always set first. Pressing the left button "Change" results in the displayed digit being increased by 1. After the digit has reached 9 it will revert back to 0 again. Pressing the right button (Next) once takes the diver to the units digit.

Upon arriving at the units digit for the helium content it is possible to save the gas data by pressing the right button "Save" and switch the to next entry. The current entry is marked with a "▶".

- The "A" in front of the gas number indicates the active gas. This cannot be deleted, i.e. setting 0% O2 and 0% helium generates an error message. However, the gas can be adjusted at any time.
- The gases set are used for the projection of the total Time To Surface (TTS). It is therefore essential to define only those gases that are actually available.
- Decompression of the current active gas is correctly calculated.
- All gases with 0% oxygen and 0% helium are automatically hidden in the "Select Gas" menu.
- The gases can also be adjusted underwater.

6.21.10 CC Gases

The fourth submenu of the system setup is "CC Gases". Using this menu item it is possible to configure all 5 gases for the closed circuit (CC) mode. The individual options and configurations are identical to those in the "Define Gas" area, in the dive setup menu. However, all 5 gases are displayed simultaneously here.

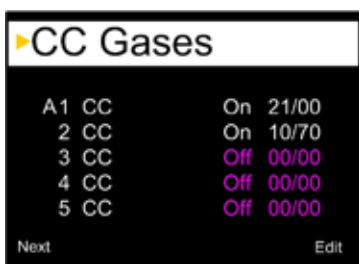

The sequence in which the gases are input is irrelevant. In the "Select Gas" menu all available gases are always displayed in order according to their O2 content (from the highest to the lowest).

- If two gases have the same O2 content then the gas with the lower helium content is brought to the front of the sequence.

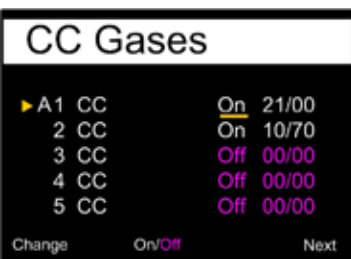
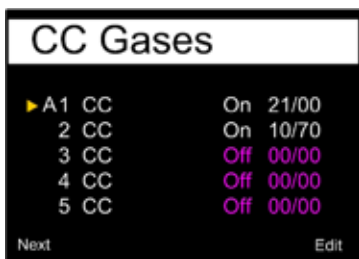

By pressing the right button "Edit" the user accesses the edit mode. The "▶" symbol moves to gas number 1. By pressing the left button "Next", it moves to the next gas number. By pressing the right button "Edit" it is possible to adjust the gas.

First you select whether a gas is active (= On) or not active (= Off). The active gases are used for the projection of the total Time To Surface (TTS) and gas switches. It is therefore essential to define only those gases that are actually available.

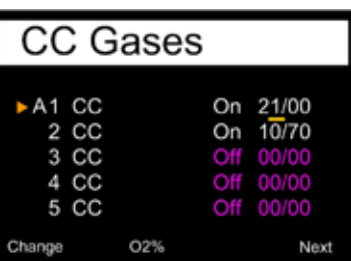
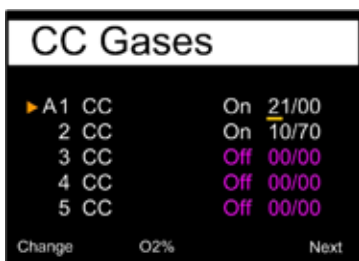

After that the O2 content of the gas is set. Only one digit of the number is changed at a time. The ten's are always set first. Pressing the left button "Change" results in the displayed digit being increased by 1. After the digit has reached 9 it will revert back to 0 again. Pressing the right button (Next) once takes the diver to the units digit.



Next, the helium content of the gas is set. Only one digit of the number is changed at a time. The ten's are always set first. Pressing the left button "Change" results in the displayed digit being increased by 1. After the digit has reached 9 it will revert back to 0 again. Pressing the right button (Next) once takes the diver to the units digit.

Upon arriving at the units digit for the helium content it is possible to save the gas data by pressing the right button "Save" and switch the to next entry. The current entry is marked with a "▶".

- The "A" in front of the gas number indicates the active gas. This cannot be deleted, i.e. setting 0% O2 and 0% helium generates an error message. However, the gas can be adjusted at any time.
- The gases set are used for the projection of the total Time To Surface (TTS). It is therefore essential to define only those gases that are actually available.
- Decompression of the current active gas is correctly calculated.
- All gases with 0% oxygen and 0% helium are automatically hidden in the "Select Gas" menu.
- The gases can also be adjusted underwater.

6.21.11 O2 Setup (Overview) ● ● ●

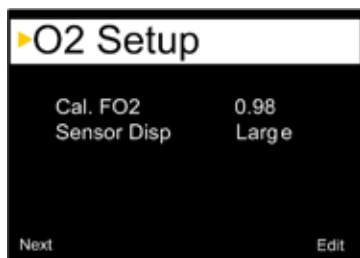

The fifth submenu is "O2 Setup". Here, it is possible to change oxygen and the size of the PPO2 display related settings.

6.21.12 Cal. FO2 (O2 Setup) ● ● ●

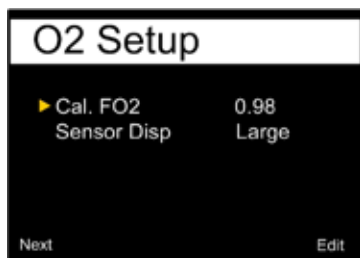

Using this menu item it is possible to change the calibration gas for the oxygen sensors.

- If 100% oxygen is used, an FO2 of 1.00 should be set for calibration.
- As soon as the FO2 has been changed and stored, calibration of the O2 sensors is invalid and "FAIL" appears on the display in place of a number for all three sensors. PPO2 values are only displayed once again after successful calibration!

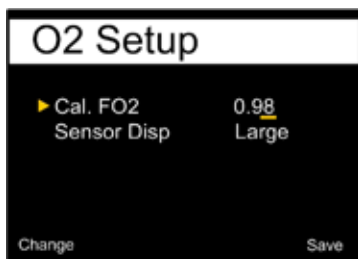
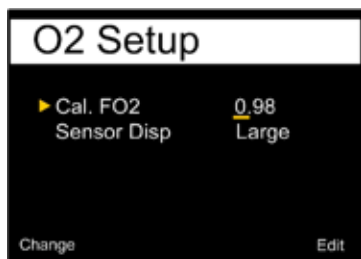

By pressing the right button "Edit" the user accesses edit mode. After this it is possible to change the first digit by pressing the left button "Change". Pressing the right button "Next" results in a jump to the next digit. It is now possible to change this using the left button "Change". By pressing the right button "Save" the current value is saved and the user exits edit mode.

6.21.13 Sensor Disp (O2 Setup) ●●●

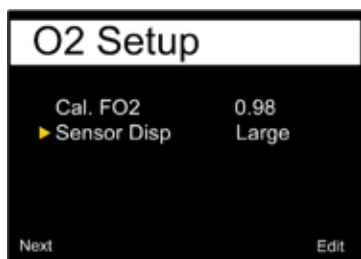

Using this menu item it is possible to change the size of the PPO2 display.

Setting	Description
Large	The PPO2 text is the normal large font.
Giant	The PPO2 text is very large.

6.21.14 Auto SP Switch ●●●

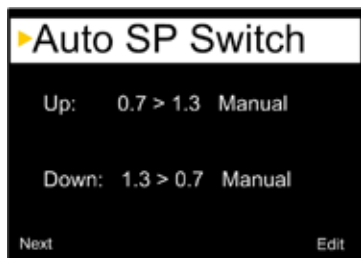

Using this menu item it is possible to activate or deactivate the automatic switching of the setpoint. In addition, it is possible to set the depth at which a switch from the low to high setpoint should take place (e.g. when descending) and the depth at which the reverse - from high to low setpoint - should take place (e.g. when ascending). It is naturally also possible to manually switch between the low and high setpoint if necessary, via the menu item "Switch Setpoint" (Chapter 6.10).

The following variants can be defined:

- Only SP UP (Low to High Setpoint) switched on
- Only SP Down (High to Low Setpoint) switched on
- Both Auto SP switched on
- No automatic setpoint switching.

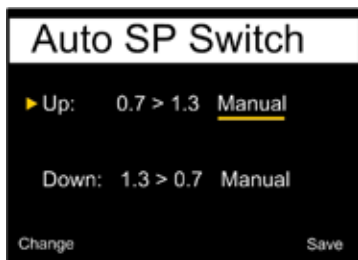
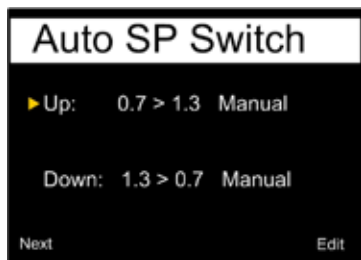

By pressing the left button the user accesses the edit mode. In edit mode, pressing the left button "Change" results in a switch between the "Auto" and "Manual" settings. Pressing the right button saves the current setting. With the "Auto" setting an additional line is displayed.

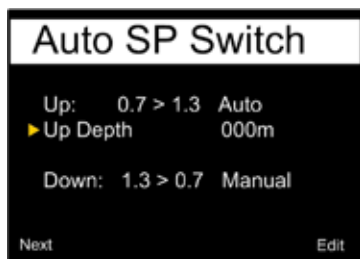

Here, the user now defines the depth at which the setpoint is to be switched automatically from low to high. By pressing the right button "Edit" the user accesses the edit mode.

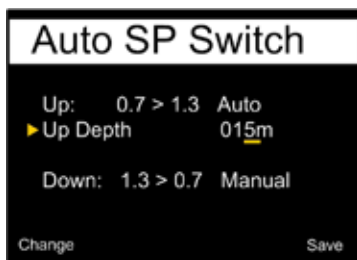
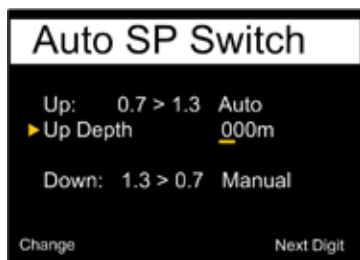

Pressing the left button "Change" results in the first digit (0-9) being changed. Pressing the right button "Next Digit" jumps the user to the next digit. Once the user accesses the last digit, pressing the right button "Save" results in the value being stored. Permissible values are 6-999 metres.

In the left image, the controller is configured such that it will switch from the low to the high setpoint at a depth of 15 m. During an ascent no automatic switching from high to low setpoint will occur.

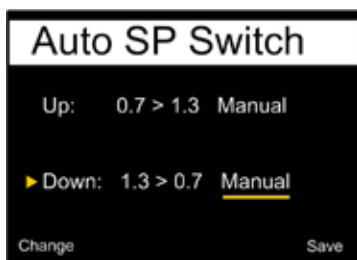
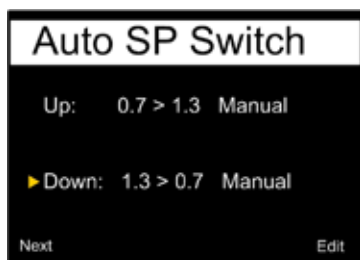

With "Down" it is possible to define the depth (when ascending) at which the controller switches from the high to low setpoint. The process of implementing the setting is identical. Permissible values are 2-999 metres.

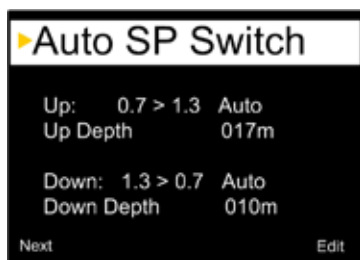

In the image to the left, the controller will switch automatically from the low setpoint (.7) to the high setpoint (1.3) at a depth of 17 metres. When ascending, the automatic switching from the high setpoint (1.3) to the low setpoint (.7) will take place at 10 metres.

- The switch down depth is enforced to be less than the switch up depth, by at least 6m.
- The minimum switch down depth is 2m. Thus, the minimum switch up depth is 8m.
- Each auto setpoint switch can occur as many times per dive as the switch depth is crossed. The 6m enforced gap between the up and down depths prevents oscillations.
- A switch up will only occur while descending (going deeper) across the switch up depth.
- A switch down will only occur while ascending (going shallower) across the switch down depth.
- If a manual setpoint switch occurs, the auto switch will be cancelled if within 2m of the auto switch depth.

6.21.15 Display Setup (Overview) ●●●

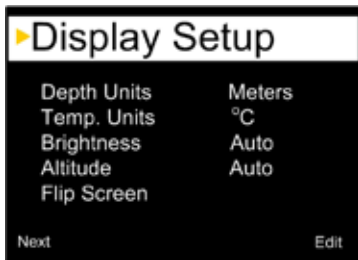

In this submenu it is possible to set all display options.

6.21.16 Depth Units (Display Setup) ●●●

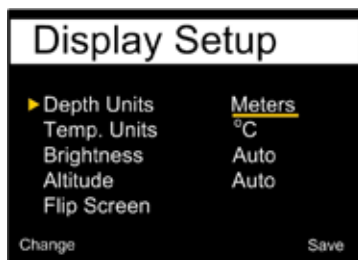
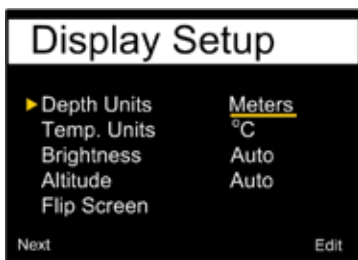

Via this menu item it is possible to switch the depth between "Meters" and "Feet".

6.21.17 Temp. Units (Display Setup) ●●●

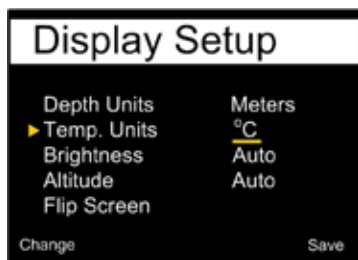
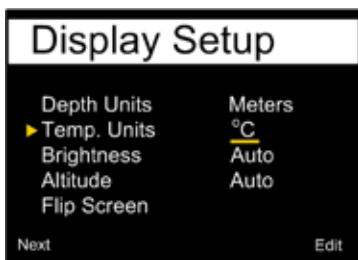

Via this menu item it is possible to switch the temperature between "°C" and "°F".

6.21.18 Brightness (Display Setup) ●●●

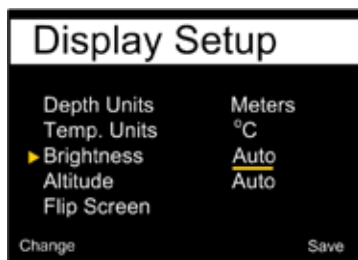
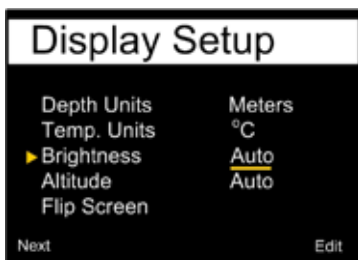

Using this menu item it is possible to set the brightness of the display. Pressing the right button "Change" switches the mode. Five different modes are available for selection:

Mode	Description
Auto	The brightness sensor measures the ambient light and automatically adjusts the brightness of the display.
Low	Permanent minimum brightness
Med	Permanent medium brightness
High	Permanent maximum brightness
Cave	Suitable for very dark environments like caves.

- The brightness of the display is the major determinant of battery life. Up to 80% of the power consumption is to power the display. When a low battery alert occurs, the display brightness is automatically reduced to extend battery life.

6.21.19 Altitude (Display Setup) ●●●

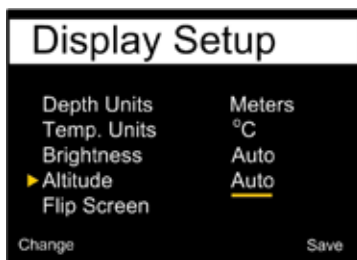
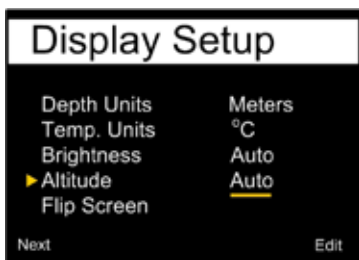

Via this option it is possible to switch the automatic altitude adjustment on or off. If this option is set to "Auto" then automatic altitude adjustment (mountain lake mode) takes place for decompression and with the calibration of the O2 sensors.

If all dives take place at sea level then the user can select "SeaLvl". This results in a surface pressure of 1013mBar being selected every time.

- When surface pressure is less than 960 millibar, the controller forces the use of "Auto" altitude setting (i.e. cannot use the "SeaLvl" setting).

6.21.20 Flip Screen (Display Setup) ●●●

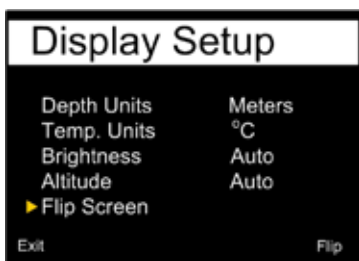

Via this menu item it is possible to flip the controller display through 180 degrees. The assignment of both buttons is also flipped through 180 degrees!

6.21.21 Compass (Overview)

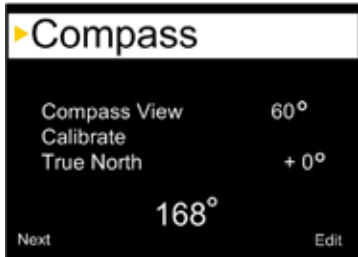

In this submenu it is possible to calibrate the compass and set all options for it.

Like any magnetic compass, there are some limitations. Understanding these limitations will help ensure accurate navigation:

- Metal objects, permanent magnets, and other sources of magnetic interference such as electric motors should be kept away from the compass. We recommend comparing the compass accuracy to a known good compass with and without the interfering object in place to see if it has an effect.
- Being inside or near a shipwreck may also affect the compass heading.
- Magnetic declination (also called magnetic variation) is the difference between magnetic and True North. This can be compensated with the true north menu item. The magnetic declination varies around the world, so will need to be readjusted when travelling.

6.21.22 Compass View (Compass)

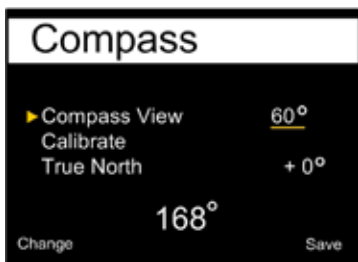

Via this menu item you can switch off the compass or change the compass dial that is visible on the main screen.

Setting	Description
Off	If the compass is set to off, then the compass display does not appear as the first info screen and the "Mark Compass" menu is not available.
60° / 90° / 120°	Sets the range of the compass dial that is visible on the main screen. The actual amount of arc that is shown on the screen is 60°, so this may seem the most natural. The 90° or 120° setting can be used to see a wider range.

6.21.23 Calibrate (Compass) ●●●



Via this menu item you can calibrate the compass or reset it to the factory settings. To calibrate the compass: Press calibrate and then rotate in as many 3D orientations as possible for 15 seconds: Upside down, sideways, on edge, etc.

- Calibrate the compass before first use.
- Calibrate the compass after every battery replacement.
- Compare the compass with a known good compass or fixed references to determine if calibration is needed.
- After calibration, it is recommended to compare the compass accuracy with a known good compass or fixed references.
- Calibration is not needed when travelling to different locations. The adjustment needed then is the True North (declination).

6.21.24 True North (Compass) ●●●

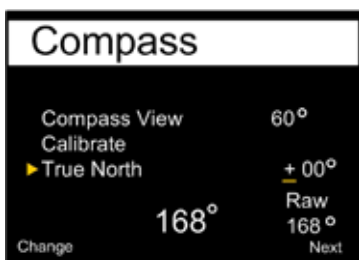

In most places, a compass does not point towards True North, but rather to Magnetic North. The difference in angle between these two directions is called the magnetic declination (also called magnetic variation), and varies around the world. The declination in your location can be found on maps or online.

- If you only need to match an uncompensated compass, or your navigation is all based on relative directions, then this setting is not necessary and can be left at 0°.

6.21.25 System Setup (Overview) ●●●

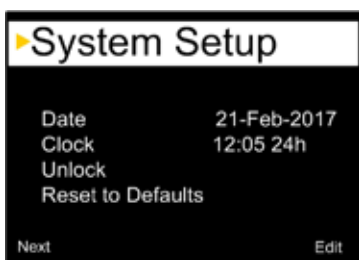

In this submenu it is possible to implement various system settings.

6.21.26 Date (System Setup) ●●●

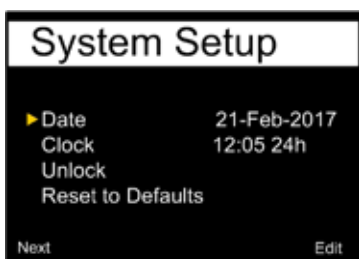

Using this menu item it is possible to set the current date. The date is used for the controller logbook. The sequence is: day/month/year.

- The date and time is displayed with the info screens (see chapter 6.23).

6.21.27 Clock (System Setup) ●●●

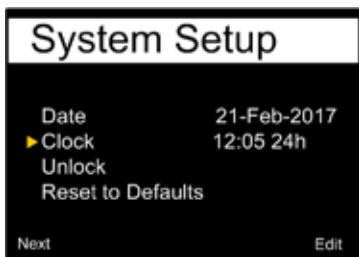

Using this menu item it is possible to set the current time. The time is used for the controller logbook. The time can be displayed in AM/PM or as 24 hour format.

- The date and time is displayed with the info screens (see chapter 6.23).

6.21.28 Unlock (System Setup) ●●●

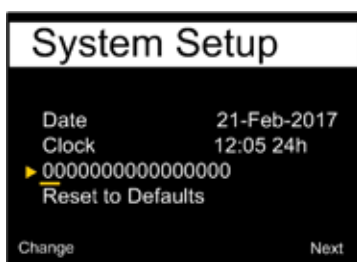
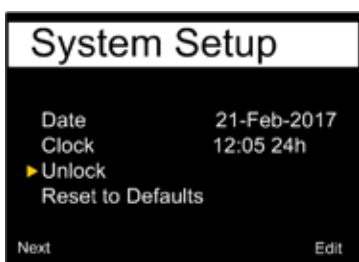

This menu item enables the entry of a code in order to release additional controller functions. (E.g. VPM decompression model).

Pressing the right button "Unlock" displays a line with numerous "0". Pressing the left button "Change" facilitates changing the current character. Possible numbers and letters are 0-9 and A-F. Pressing the right button results in a jump to the next character. Once the user accesses the last character, pressing the right button results in the unlock code being stored and implemented.

6.21.29 Reset to Defaults (System Setup) ●●●

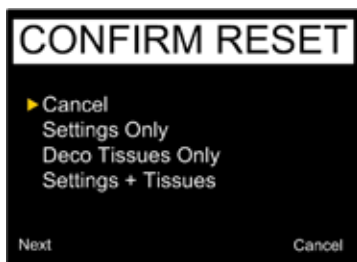
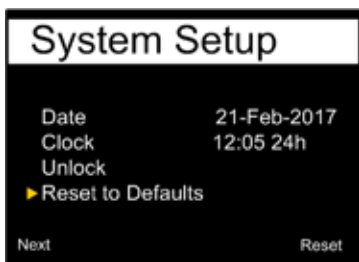

The option resets all controller settings to the factory settings. The reset needs to be confirmed and the user can select the following options:

- Settings Only
- Deco Tissues Only
- Settings + Tissues

- This option deletes neither the internal logbook nor the dive numbers.

6.21.30 Advanced Config (Overview)

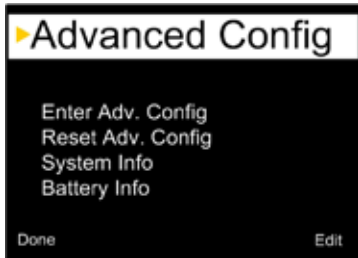

This sub-menu allows changes for values that will not need frequent adjustment. At the top level menu, you can either enter the “Advanced Configuration” or reset the “Advanced Configuration” values to their defaults. The option “System Info” shows various system information and the option “Battery Info” provides some additional information about the controller battery.

6.21.31 System Info (Advanced Config)

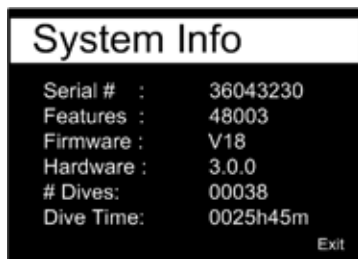
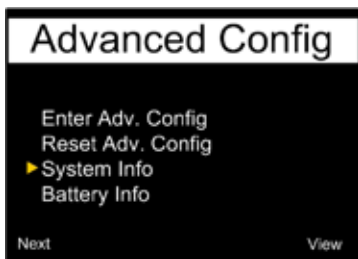

This option shows some additional system information:

Info	Description
Serial	The controller’s serial number
Features	The controller’s activated features
Firmware	The controllers firmware version
Hardware	The controllers mainboard revision
Dives	Total livetime dive count
Dive Time	Total livetime dive time in hours and minutes

6.21.32 Battery Info (Advanced Config)

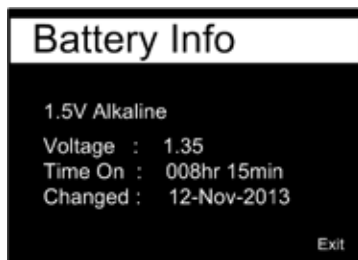
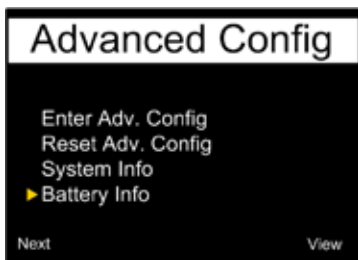

The battery info screen shows:

Info	Description
1.5V Alkaline	Battery type
Voltage	Current voltage
Time On	Time on since last battery change
Change	Date of last battery change

6.21.33 Main Color (Advanced Config 1) ●●●

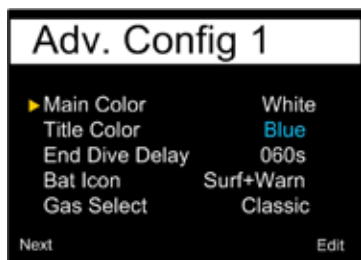

The main colours can be changed for added contrast or visual appeal.

The available colours are: white and green.

6.21.34 Title Color (Advanced Config 1) ●●●

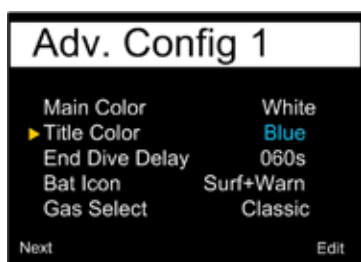

The title colours can be changed for added contrast or visual appeal.

The available colours are: white, gray, blue and cyan.

6.21.35 End Dive Delay (Advanced Config 1) ●●●

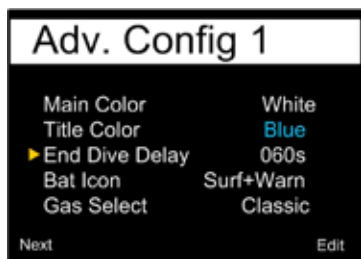

This option sets the time in seconds to wait before ending the current dive. This value can be set from 20 seconds to 600 seconds (10 minutes). The default value is 60 seconds. Since the controller can stay in dive mode for a longer time, a new "End Dive" menu option has been added (Chapter: 6.12). This is the first menu option when the controller is still in dive mode and when the diver is at the surface.

6.21.36 Bat Icon (Advanced Config 1) ●●●

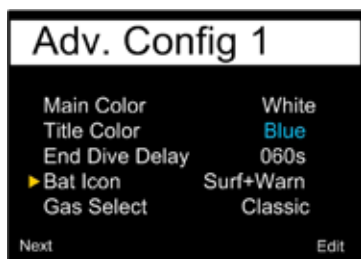

The behavior of the battery icon can be changed here. The available Options are:

Mode	Description
Warn Only	The battery icon only appears when there is a low battery warning (Default).
Always	The battery icon always displays.
Surf + Warn	The battery icon displays always when on the surface. During dive it displays only if there is a low battery warning.

6.21.37 Gas Select (Advanced Config 1) ●●●

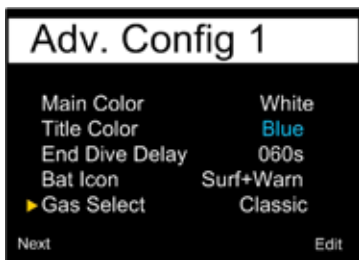

This option allows to change the style of the "Select Gas" menu. You can choose between the "Classic" and "New" style. The classic style shows one gas with a big font. The new style shows all gases at the same time with a small font. Please refer to chapter 7 for a detailed description.

6.21.38 Advanced Config 2 (Overview) ●●●

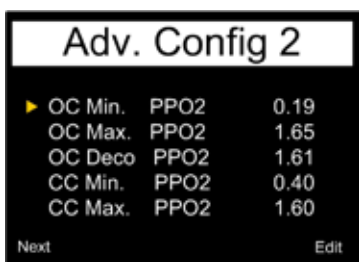

The "Advanced Config" page 2 allows the changing of the PPO2 limits.

WARNING: Do not change these values unless you understand the effect

- A "Low PPO2" or "High PPO2" alert is displayed when the limits are violated for more than 30 seconds.

Setting	Description
OC Min. PPO2	PPO2 displays in flashing red when less than this value. The default is 0.19.
OC Max. PPO2	PPO2 displays in flashing red when higher than this value. The default is 1.65.
OC Deco PPO2	The decompression predictions (TTS and NDL) will assume that the gas in use at a given depth is the gas with the highest PPO2 that is less than or equal to this value. Also, the suggested gas switches (when the current gas is displayed in yellow) are determined by this value. If you change this value, please understand its effect. For example, if lowered to 1.50, then oxygen (99/00) will not assumed at 6m. The default is 1.61.
CC Min PPO2	PPO2 displays in flashing red when less than this value. The default is 0.40.
CC Max. PPO2	PPO2 displays in flashing red when higher than this value. The default is 1.60.

6.21.39 Advanced Config 3 (Stack Timer) ●●●

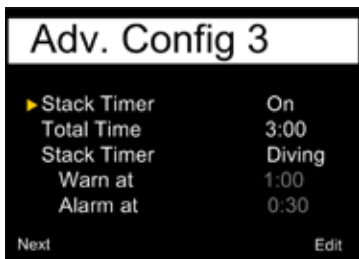

The "Advanced Config 3" allows to configure the "Stack Timer" (CO2 scrubber duration timer).

Setting	Description
Stack Timer	Toggles the "Stack Timer" on or off
Total Time	The total time can be set anywhere between 1h and 9h 59m.
Stack Timer	The stack timer can be set to count down either when diving, or when the computer is ON.
Warn at	Not changeable - Shows a warning when stack time is less than 1 h.
Alarm at	Not changeable - Show an alarm when stack time is less than 30m

6.22 Bus Devices ●●●

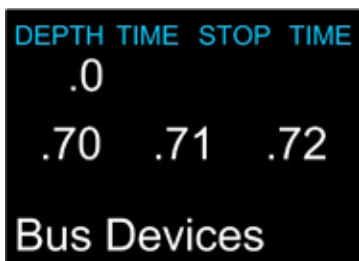

The "Bus Devices" info screen shows a list of all DiveCan® devices. It also allows changing settings on peripheral boards. For example, on the SOLO board (solenoid and oxygen controller) the Solenoid Speed setting can be adjusted.

6.22.1 SRI Petrel (Bus Devices) ●●●



The Petrel is not a peripheral board and there are no options available.

6.22.2 SRI SOLO (Bus Devices) ●●●





On the SOLO board (solenoid and oxygen controller) the Solenoid Speed setting can be adjusted.



Solenoid speed setting can be set to either the 1 second or 5 second PID control algorithm. This feature is comparable with the "slow" and "fast" solenoid setting, which was available on the classic JJ-CCR (Shearwater Predator based controller). The setting is edited on the controller, but are stored in the SOLO board.

The 5 second PID control algorithm is the default setting. With the 1 second PID control the PPO2 can be more precisely maintained but the solenoid is operational more often in order to constantly supply small volumes of oxygen. This results in much higher use of the battery. Many divers also find the constant operating noise of the solenoid annoying.

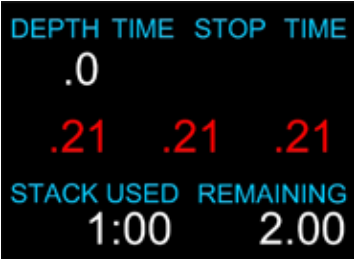
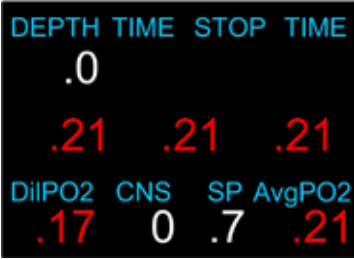

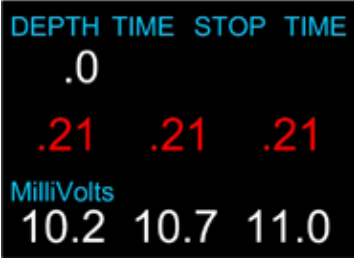
6.23 Info Screens ●●●

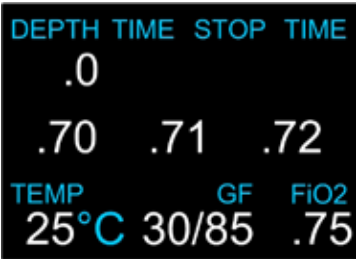
Starting from the main screen, the right button steps through the info screens. Info screens time-out after 10 seconds, returning to the main screen. Pressing the left button will also return to the main screen. When enabled the compass is shown as the first info screen. Unlike the regular info screens, the compass never times out back to the main screen.

Info Screens	Description
<p style="text-align: center;">CC mode</p> 	<p>Shows the used and remaining stack time.</p>
<p style="text-align: center;">CC mode</p>  <p style="text-align: center;">BO mode</p> 	<p>DilPO2: Displays the current PPO2 of the diluent. If the value is lower than 19 or higher than 1.65 then it flashes red.</p> <p>CNS: Shows the current CNS saturation as a percentage: From 100% or above, the value flashes red. The CNS saturation is calculated constantly, also at the surface and even if the computer is switched off.</p> <p>SP: Displays the current active setpoint. The setpoint .19 is displayed in yellow. All other setpoints in white.</p> <p>AvgPO2: Indicates the average PO2 of the breathing gas. The basis for calculation is the average of the measured values of all sensors which have not been excluded. If the value is lower than .40 or higher than 1.60 then it flashes red.</p> <p>CNS: Shows the current CNS saturation as a percentage: From 100% or above, the value flashes red. The CNS saturation is calculated constantly, also at the surface and even if the computer is switched off.</p> <p>AvgPO2 (BO Mode): Indicates the average PO2 of the breathing gas. If the value is lower than .19 or higher than 1.65 then it flashes red.</p>
<p style="text-align: center;">CC and BO mode</p> 	<p>Indicates the current millivolts of the connected O2 sensors.</p>

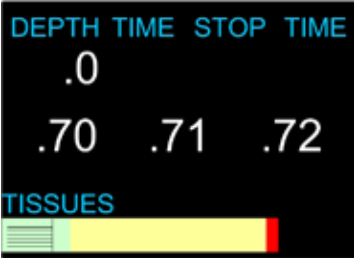
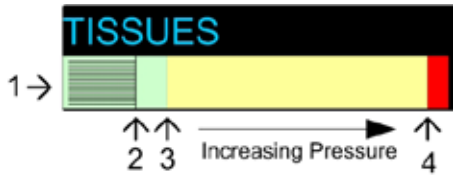
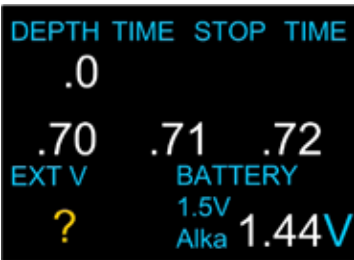
Info Screens	Description
<p>CC und BO mode</p> 	<p>MAX: Indicates the maximum depth of the current dive. When not in dive mode, the maximum depth of the last dive is displayed here.</p> <p>AVG: Indicates the average depth of the current dive. When not in dive mode, the average depth of the last dive is displayed here.</p> <p>AvgATM: AvgATM: Indicates the average depth of the current dive in absolute pressure (= 1.0 ATM equals sea level).</p>
<p>CC and BO mode</p> 	<p>TEMP: Shows the current temperature in degrees Celsius.</p> <p>GF: Shows the set low and high gradient factors.</p> <p>FIO2: Shows the oxygen concentration of the breathing gas. This value is independent of the ambient pressure!</p>
<p>CC and BO mode</p> 	<p>GF99: Shows the current M-value gradient as a percentage. If no outgasing is taking place, "On Gas" is displayed.</p> <p>CEIL: Indicates the upper limit of the ceiling in metres.</p> <p>@+5: Indicates the new TTS if the diver were to stop for 5 further minutes at the current depth.</p> <p>TTS: Shows the current TTS.</p>

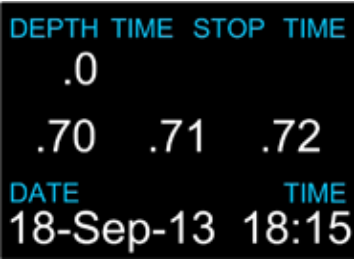
Info Screens	Description
<p>CC and BO mode</p> 	<p>The tissues bar graph shows the tissue compartment inert gas tissue tensions based on the Bühlmann ZHL-16C model. Note that VPM-B also tracks tensions in the same way.</p> <p>The fastest tissue compartment is shown on the top, and the slowest on the bottom. Each bar is the combined sum of the nitrogen and helium inert gas tensions. Pressure increases to the right.</p> <p>The vertical black line shows the inert gas inspired pressure. The boundary between the green and yellow zones is the ambient pressure. The boundary between the yellow and red zone in the ZHL-16C M-Value pressure.</p> <p>Note that the scale for each tissue compartment above the green zone is different. The reason the bars are scaled in this way is so that the tissues tensions can be visualized in terms of risk (i.e. how close they are as a percentage to Bühlmann's original super-saturation limits). Also, this scale changes with depth, since the M-Value line also changes with depth.</p>  <p>1 = 16 tissue compartments 2 = Inspired inert gas pressure 3 = Ambient pressure 4 = M-value pressure</p>
<p>CC and BO mode</p> 	<p>Ext V: Indicates the current voltage of the battery for the solenoid under load in volts. When not under load, the value may be incorrect and much too high, providing an entirely inaccurate picture of the battery condition. If, in place of a value a "?" is displayed then this shows that the solenoid has not yet been actuated and the controller has been unable to carry out any measurement. If the voltage of the batteries is very low then the value is displayed in red.</p> <p>Int V: Shows the current voltage of the controller battery in volts. The value is displayed in yellow if the battery is almost empty and requires replacing. If the value is displayed in red then the battery voltage is critical and the battery should be replaced immediately.</p>





Info Screens	Description
<p>CC and BO mode</p> 	<p>Surf: Shows the surface pressure in mBar. The pressure is measured when switched on, and saved until the controller is switched off again. If the automatic altitude adjustment is switched off (altitude = Sealvl) then 1013 mBar is always displayed. The value is generally only displayed at the surface. This means when the controller is not in dive mode.</p> <p>Now: Shows the current ambient pressure in mBar. This value is also displayed in dive mode.</p>
<p>CC and BOmode</p> 	<p>Date: Displays the current date (day/month/year)</p> <p>Time: Displays the current time (hh/mm)</p>
<p>CC and BO mode</p> 	<p>Serial No: Shows the controller serial number.</p> <p>Version: Shows the model and firmware version of the controller. The last two digits stand for the installed firmware version.</p>

6.24 Alarm, error and info messages ●●●



All alarm and error messages on the controller must always be confirmed. Only then they will disappear from the display.

<div style="display: flex; justify-content: space-between;"> O2/HE CC 15/50 </div>	White text indicates normal conditions.
<div style="display: flex; justify-content: space-between;"> O2/HE CC 15/50 </div>	Yellow is used for warnings that are not immediately dangerous but should be addressed.
<div style="display: flex; justify-content: space-between;"> O2/HE CC 15/50 </div>	Flashing red is used for critical alerts that could be life threatening if not immediately addressed.
<div style="display: flex; flex-direction: column; gap: 5px;"> <div style="background-color: #cccccc; padding: 2px;">Warning</div> <div style="background-color: #cccccc; padding: 2px;">Alert</div> <div style="background-color: #cccccc; padding: 2px;">Alert</div> </div>	<p>Color blind users: The warning or critical alert states can be determined without the use of color.</p> <p>Warnings display on a solid inverted background. Warning - does not flash.</p> <p>Critical alerts flash between inverted and normal text. Critical alert - flashes.</p>

Alarm and error messages	Description
<p style="text-align: center;">Cell Warning</p> <div style="background-color: black; color: white; padding: 10px; margin-bottom: 10px;"> <div style="display: flex; justify-content: space-between; font-size: small;"> DEPTHTIMESTOPTIME </div> <div style="display: flex; justify-content: space-between;"> 24.710241 </div> <div style="display: flex; justify-content: space-between; margin-top: 10px;"> 1.311.291.25 </div> <div style="display: flex; justify-content: space-between; font-size: small; margin-top: 10px;"> O2/HENDLTTS </div> <div style="display: flex; justify-content: space-between;"> CC 21/00028 </div> </div> <div style="background-color: black; color: white; padding: 10px;"> <div style="display: flex; justify-content: space-between; font-size: small;"> DEPTHTIMESTOPTIME </div> <div style="display: flex; justify-content: space-between;"> 24.710241 </div> <div style="text-align: center; color: yellow; font-weight: bold; margin-top: 10px;">VOTING FAILED</div> <div style="display: flex; justify-content: space-between; font-size: small; margin-top: 10px;"> O2/HENDLTTS </div> <div style="display: flex; justify-content: space-between;"> CC 21/00028 </div> </div>	<p>If the measured value of an O2 sensor exhibits too high a deviation then this is excluded during the calculation of the average PPO2 (necessary for the calculation of decompression) and it flashes yellow.</p> <p>If the deviation between all three sensors is so high that all three sensors must be excluded then all values flash yellow and the notification "VOTING FAILED" appears at alternate intervals.</p>
<p style="text-align: center;">Switch Gas</p> <div style="background-color: black; color: white; padding: 10px;"> <div style="display: flex; justify-content: space-between; font-size: small;"> DEPTHTIMESTOPTIME </div> <div style="display: flex; justify-content: space-between;"> 24.710241 </div> <div style="display: flex; justify-content: space-between; margin-top: 10px;"> 1.311.291.32 </div> <div style="display: flex; justify-content: space-between; font-size: small; margin-top: 10px;"> O2/HENDLTTS </div> <div style="display: flex; justify-content: space-between;"> CC 10/50028 </div> </div>	<p>If the current gas is displayed in yellow then this is an instruction to implement a gas change because a better gas (PPO2) is available in the gas list. The controller uses all defined gases for the TTS calculation. It is necessary to change immediately to the other gas or remove the gas from the gas list because it is otherwise no longer possible to calculate the correct TTS.</p> <p>Gases can also be changed and/or added underwater at any time!</p>

Alarm and error messages	Description
<p style="text-align: center;">Gas PPO2 unsafe</p> 	<p>The gas will display in flashing red when its PPO2 is outside of a safe breathing range (i.e. below the min PPO2 or above the max PPO2 setting). In closed circuit (CC) mode, this warning refers to the diluent only. The breathing loop PPO2 may be in a safe range, but if the diluent is unsafe to breathe directly then the gas will be red. Note that other warnings exist to warn when the breathing loop is outside of a safe range.</p>
<p style="text-align: center;">High PPO2</p> 	<p>The high "HIGH PPO2" alarm message appears if a PPO2 of 1.60 has been exceeded for more than 10 seconds. With the first warning it is necessary to confirm this by pressing the right button. If, during the same dive, the PPO2 should once again be too high then it is not necessary to confirm this again (see second image). The PPO2 values and the "High PPO2" warning flash in red.</p>
<p style="text-align: center;">STACK TIME WARNING</p> 	<p>This warning shows up when the remaining stack time is less than one hour.</p>
<p style="text-align: center;">STACK TIME ALARM</p> 	<p>This alarm shows up when the remaining stack time is less than 30 minutes.</p>

Alarm and error messages	Description
<p style="text-align: center;">Low PPO2</p> <p>The first screenshot shows: DEPTH 24.7, TIME 10, STOP 24, TIME 1. Low PPO2 .32 .33 .32. Error Confirm. LOW PPO2.</p> <p>The second screenshot shows: DEPTH 24.7, TIME 10, STOP 24, TIME 1. Low PPO2 .32 .33 .32. O2/HE CC 21/00, NDL 0 28.</p> <p>The third screenshot shows: DEPTH 24.7, TIME 10, STOP 24, TIME 1. Low PPO2 .32 .62 .12. O2/HE CC 21/00, NDL 0 28.</p>	<p>The "LOW PPO2" alarm message appears if the PPO2 is lower than .40 for more than 10 seconds. With the first warning it is necessary to confirm this by pressing the right button. If, during the same dive, the PPO2 should once again be too low then it is not necessary to confirm this again (see second image). The PPO2 values and the "Low PPO2" warning flash in red.</p> <p>Another cause for this alarm message is shown in the third image. Two sensors with comparable values are not available. It is therefore not possible for the controller to determine which value is correct, and the actual PPO2 is thus unknown. In this instance the average PPO2 is calculated as 0.00. Because 0.00 is lower than 0.40, the "Low PPO2" alarm message will also appear.</p>
<p style="text-align: center;">Low Battery EXT</p> <p>The screenshot shows: DEPTH 24.7, TIME 10, STOP 24, TIME 1. .70 .71 .72. Error Confirm. LOW BATTERY EXT.</p>	<p>This alarm message appears if the voltage (< 6.6v for more than 30 seconds) of the two batteries for the solenoid is too low. The solenoid continues to function, but the batteries must both be replaced prior to the next dive.</p>
<p style="text-align: center;">Low Battery INT</p> <p>The screenshot shows: DEPTH 24.7, TIME 10, STOP 24, TIME 1. .70 .71 .72. Error Confirm. LOW BATTERY INT.</p>	<p>This alarm indicates that the controller battery must be replaced immediately. It appears if the battery voltage drops below the minimal volts for more than 30 seconds. The battery symbol also flashes red.</p>

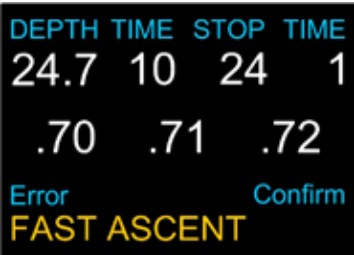
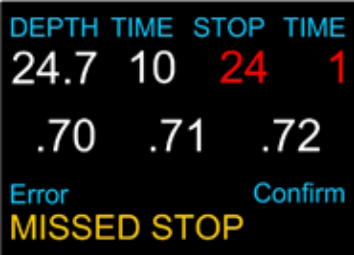
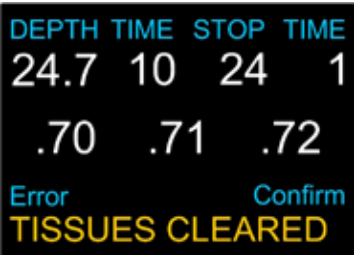
Alarm and error messages	Description
<p style="text-align: center;">Solenoid Alert</p>  	<p>If this alarm appears, it is necessary to implement the appropriate measures immediately. It indicates that the solenoid is working from the perspective of the controller, but that the PPO2 in the circuit is not changing. A possible cause for example, is that no more oxygen is present in the tank.</p> <p>With the first warning it is necessary to confirm this by pressing the right button. If, during the same dive, an identical problem should once again arise then it is not necessary to confirm this again (see second image). The PPO2 values and the "Solenoid" warning flash in red.</p>
<p style="text-align: center;">Fast Ascent</p> 	<p>The "Fast Ascent" alarm message appears if the diver ascends very quickly within a short space of time, or if his speed has been faster than 20 metres per minute for longer than one minute.</p>
<p style="text-align: center;">Missed Deco Stop</p> 	<p>The "Missed Deco Stop" alarm message appears if the diver exceeds the minimum depth of the current decompression stop for more than one minute.</p>
<p style="text-align: center;">Tissues Cleared</p> 	<p>The "Tissues Cleared" alarm indicates that all current tissue calculations have been deleted. A minimum of 24 hours should therefore be allowed before the next dive.</p>

Alarm and error messages	Description
<p style="text-align: center;">Upgrade Reset</p> 	<p>This message always appears after every successful firmware update. It indicates that the controller has been started with new firmware.</p>
<p style="text-align: center;">Needs Cal.</p> 	<p>This message appears after a firmware update of the controller. "Needs Cal." and "Fail, Fail, Fail" are alternately displayed. This means that the oxygen sensors must be calibrated.</p>
<p style="text-align: center;">Watchdog Reset</p> 	<p>This alarm happens when the controller does not complete all of its tasks in the time allowed. It can happen occasionally from a transient problem like a battery bounce after an impact. It can also be the result of a hardware problem.</p>
<p style="text-align: center;">Internal Hardware Failures</p> 	<p>The following error messages relate to internal hardware failures. The controller attempts to eliminate these, but it is generally the case that something has happened that should not have occurred. These error messages should always be recorded and the nearest service centre duly informed.</p> <p>This is not an exhaustive list of all internal hardware error messages.</p>

6.25 Changing the battery



NOTE: A large coin or washer is required for this section.

- 1. Turn off the controller:** It is a good practice to turn off the controller before removing the battery. If removed while on, then there is a small chance (about 1 in 5000) that the deco tissues will be corrupted. The controller detects this using a cyclic redundancy check (CRC), so there is no danger. However, the tissues will be lost and repetitive dives will need to be planned accordingly.
- 2. Remove the battery cap:** Insert the coin or washer into the battery cap slot. Unscrew by turning counter clockwise until the battery cap is free. Be sure to store the battery cap in a clean dry space.
- 3. Exchange the battery:** Remove the existing battery by tilting the controller. Insert the new battery positive contact first. A small diagram on the bottom of the controller shows the proper orientation.
- 4. Accepted battery types:** The controller can accept a wide variety of AA sized batteries. The controller can accept any AA sized (or 14500 size) battery that outputs a voltage between 0.9V and 4.3V. JJ-CCR ApS strictly recommends to use only a SAFT LS 14500 battery for the controller. Please refer to chapter 6.25.1 for more information.
- 5. Reinstalling the battery cap:** It is very important that the battery cap O-ring is clear of dust or debris. Carefully inspect your O-ring for any debris or damage and gently clean. It is recommended that you lubricate your battery cap's O-ring on a regular basis with an O-ring lubricant compatible with Buna-N (Nitrile) O-rings. Lubricating helps ensure that the O-ring seats properly and does not twist or bunch.



IMPORTANT: Replace the O-ring at least once a year or after every 3 battery changes!

Insert the battery cap into the controller and compress the battery contact springs. While the springs are compressed rotate the battery cap clockwise to engage the threads. Be sure not to cross thread the battery cap's threads. Tighten the battery cap until snug. Do not over tighten the battery cap.

Tissues Cleared: After tighten the battery cap the controller will switch on automatically. Some conditions will cause the decompression inert gas tissue loadings to be cleared. When cleared, the tissues are set to being saturated with breathing air at the current barometric pressure.

The controller does not lock-out when the tissues are cleared. If the tissues are cleared, then the diver must take appropriate cautions when planning repetitive dives. The controller clearly notifies when tissues are cleared, so that the diver has the proper information to make responsible decisions.

For example, after changing the battery, you will see one of these two screens:

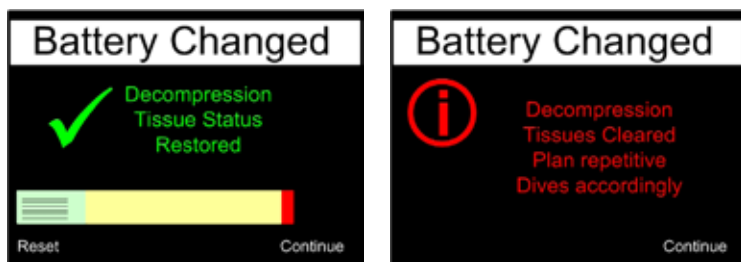

Normally you should see the confirmation that the controller restored the tissues status. Conditions that cause the tissues to be cleared are:

Firmware Updates: A Firmware update will clear the tissues. Therefore, updating the firmare in the middle of a dive trip is not a good idea.

Slow Battery Change: Quick battery changes do not normally cause the tissues to be cleared. A super capacitor stores energy to keep the clock running for at least 15 minutes during a battery change. If battery removed for longer than 15 minutes, then the tissues will be cleared.

User request: You can clear the tissues manually in the “System Setup” menu. Use the Reset To Defaults option. This will then prompt if you want to reset the settings only, the tissues only, or both.

Corruption: A 32-bit cyclic redundancy check (CRC) is used to verify the integrity of the tissues each time the controller is turned on. If corrupted, the tissues will be cleared. The most likely cause of corruption is removing the battery with the controller turned on. Therefore, turning the controller off before changing the battery is the best practice.

6. Confirm inserted battey type, time and date, calibrate compass: The controller tries to automatically recognize the inserted battery type by its voltage. If the controller displays the wrong battery type, you can manually change it.

- Having the battery type set correctly is important so that the controller can give low battery warnings at the proper voltage levels..

The next screen shows the time and date. Should they be wrong, you can manually change them. The last screen allows to calibrate the compass. This should be done after every battery change.



6.25.1 Battery Types

Supported battery types for the controller are:

Saft LS 14500 3.6 V Lithium Batterie: The Saft LS14500 lithium batteries provide very high energy density. Provide about 100 hours of operation. Can die quickly, so care should be taken to ensure sufficient charge prior to diving. On the basis of the very long run time it is the recommended battery for the JJ-CCR controller.

1.5 V Alkaline: The common AA battery type that can be purchased at most supermarkets and electronics stores around the world. Not rechargeable. Inexpensive and reliable, they provide 35 hours of operation.

- Alkaline batteries are especially prone to leaking corrosive battery acid when completely discharged. Remove discharged batteries immediately, and do not store your controller for more than 2 months with an alkaline battery installed.

1.5 V Photo Lithium: Fairly common, but more expensive than alkalines. They provide about 55 hours of operation. Not rechargeable. Good for use in very cold water.

1.2 V NiMH: Common rechargeable batteries used in digital cameras and photo flashes. Can have high self discharge. Provide about 30 hours of operation per charge. Can die quickly, so care should be taken to ensure sufficient charge prior to diving.

3.7 V Li-Ion: Rechargeable 14500 Li-Ion batteries provide about 35 hours of operation per charge. Can be ordered from the internet. Have more gradual voltage drop as discharged, so easier to determine remaining capacity than NiMH rechargeables. Good in cold water.

- Note: Battery operating lifetimes are given with screen on medium brightness and at room temperature. Higher brightness and lower temperature can reduce life. Lower brightness can increase life.

6.26 Firmware Update

DEPTH TIME STOP TIME
 .0
 .70 .71 .72
 SERIAL NO VERSION
 55990C0 4800338

The controller's firmware can be self-updated. The version currently installed is visible on the info screen display (see chapter 6.23). In this example, firmware version 38 is installed on the controller.

- The specific modifications to the JJ-CCR firmware are contained in the regular firmware of the controller manufacturer.
- **IMPORTANT:** An upgrade to new firmware can only be carried out if we have approved this for the JJ-CCR Rebreather!
- In order to upgrade the firmware the user requires a computer with a Windows operating system (XP – Service Pack 2 or 3, VISTA or Windows 7) or an Apple Mac (Intel Core Duo) with OS X 10.4.9 or higher.
- The latest version of the “Shearwater Desktop” Software must be installed on the computer.
- Windows systems: The USB Bluetooth adapter provided must be connected to the computer and Windows must have the correct driver installed for this (Original Windows Bluetooth or WidComm driver). Other Bluetooth drivers such as those from Toshiba do not work with the software!
- Apple Mac: All Apple Macs have an integrated Bluetooth interface that can be used for the firmware update. The USB Bluetooth adapter provided is not compatible with Apple systems and must not be used.

6.27 Step-by-step Firmware Update

The following chapter provides a step-by-step description of the firmware update. The images show the upgrade with a Mac system. The process is identical with an Windows PC.

- Start the Shearwater Desktop Software.
- In the “Dive Computer” menu select the option “Update Firmware”.

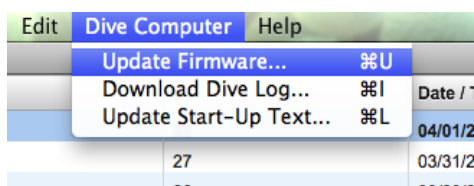

- Select “Petrel 1 & 2” as dive computer
- Switch on the controller. In order to prevent constant solenoid triggering, it is possible to set the setpoint to .19.
- Select “Start Bluetooth”

DEPTH TIME STOP TIME
 .0
 .70 .71 .72
 Start Bluetooth

- Shearwater Desktop will detect your controller and select the latest available firmware.
- Choose your language, then press "Yes, Update" to install the latest firmware.
- After that, Shearwater Desktop will send the firmware update to your controller.
- Once all data has been transferred, the Bluetooth connection is closed automatically and the controller starts to control the integrity of the new firmware. Do not remove the battery during the upgrade process. Once the firmware has been updated the controller automatically starts up again.
- The controller displays a message stating either firmware upgrade success or failure. After that it displays a warning that all decompression tissues have been cleared and to plan repetitive dives accordingly.



6.28 Controller Personalization (Start-Up Text) ●●●

You can personalize the controller with a start-up text of two lines with maximal 21 characters (E.g. name and phone of the owner).

- Umlauts are not supported for the start-up text.
- Start the Shearwater Desktop Software.
- In the "Dive Computer" menu select the option "Update Start-Up Text".
- Enter the start-up text.
- Start Bluetooth on the Controller.
- Click on "Start".
- The start-up text will now be transferred to the controller. It will appear the next time you switch on the controller.

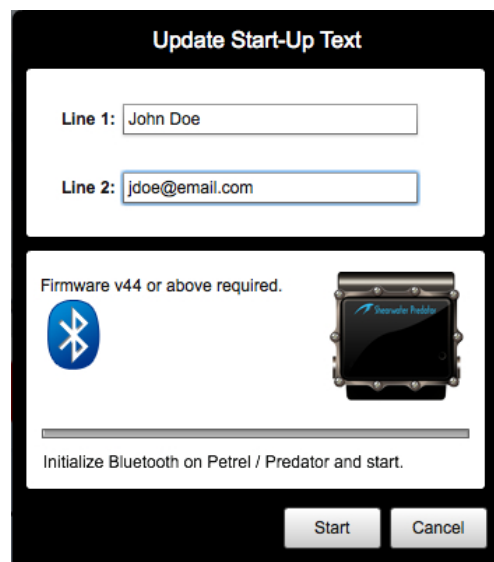

7 Gas Select (New / Classic)

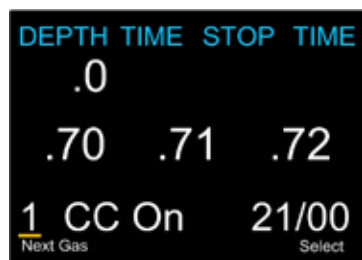

The manufacturer of the controller added a new display style for the gas select during a dive. The new "Gas Select" style is an option. The new and classic "Gas Select" style can be switched in the "Adv. Config 1" menu (see chapter 6.21.37).

The left picture shows the classic gas switch and the right picture the new gas switch. The advantages of the new "Gas Select" style are:

- All gases shown simultaneously.
- Easier to visualize and understand.
- Fewer button presses during deco gas switches.

The disadvantages of the new "Gas Select" style are:

- Smaller font.
- More information to process simultaneously.

7.1 Gas Select (New Style)

The new "Gas Select" style shows all gases simultaneously. The currently active gas is displayed with a white background. The gases are sorted from highest to lowest oxygen content! If two gases have the same oxygen content then the gas with the lower helium content is brought to the front of the sequence.

- Only the active gases of the current mode are displayed. E.g. when the controller is in closed circuit (CC) mode - only the active CC gases are displayed and when the controller is in open circuit (BO) bailout mode, you will only see the active BO gases.

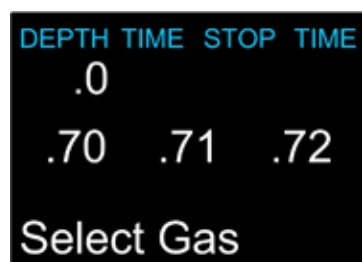

During a dive that had deco stops, upon entering this menu, the first gas pointed to will be the most appropriate gas for the current depth (i.e. highest PPO2 under 1.60). This reduces button presses in most cases. On the surface or when no deco stops are needed, the first gas pointed to will be the active gas. Note that this behavior differs from the classic style, where the first selection is always the gas with the highest O2%.

7.2 Define Gas (New Style) ●●●

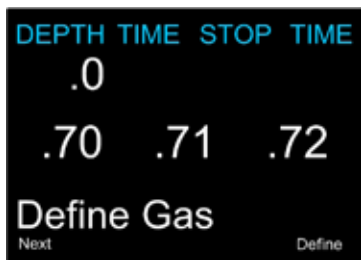

The new “Select Gas” style has an impact for the “Define Gas” option in the “Dive Setup” menu. All gases shown simultaneously. The current active gas is displayed with a white background. All not active gases are displayed with magenta.



Whilst in the “Define Gas” edit mode, you can turn on or off a gas. The rules are identical to the classed “Select Gas” style. The current active gas can be changed, but not turned off.

After turning on a gas you can specify the O2 and HE content in percent. The order how you enter the gases does not matter.

8 VPM-B / VPM-GFS decompression model ●●●

Additionally to the standard Bühlmann GF decompression model, you can also use VPM-B or VPM-B/GFS as decompression model on your JJ-CCR controller. The unlock code for the VPM-B must be purchased as an option.

- The VPM-B calculations on the JJ-CCR controller run every 5 to 10 seconds. This means the JJ-CCR controller will best match a desktop planner (like VPlanner) when the minimum stop time is set to 10 seconds.

8.1 Deco Model ●●●

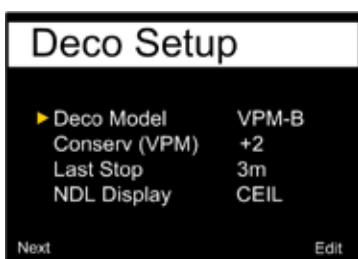

You can choose between three decompression models.

- Bühlmann GF
- VPM-B
- VPM-B/GFS

The Gradient Factor Surfacing (VPM-BG) option adds conservatism to the shallow stops on dives with significant decompression requirements (typically > 1 hour deco). The GFS extension automatically chooses the decompression ceiling from the more conservative of the VPM-B profile and a Bühlmann ZHL-16C profile. For the Bühlmann profile a single gradient factor, adjustable over a range of 70% to 99%, is used.

- The selected decompression model is automatically used within the “Dive Planner (Chapter: 6.14.4).
- Within the info screen display it shows the used decompression model and the selected gradient factors or conservatism.

8.2 Conserv. (VPM) ●●●

Using this menu item it is possible to set the conservatism for the calculation of the decompression.

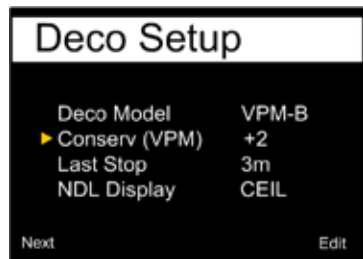

Model	Conservatism
VPM-B	The adjustable conservatism is from 0 to +5. Higher numbers create more conservative (longer decompression) profiles. The most aggressive setting is 0, and the most conservative is +5. The default is +3
VPM-B/GFS	The VPM-B/GFS allows you to adjust the conservatism from 0 to +5. Additionally you can adjust the GFS value. For the GFS value, higher values are less conservative. The most aggressive setting is 99% and the most conservative is 70%. The default value is 90%

- It is possible to change the conservatism during the dive within the “Dive Setup” menu (Chapter: 6.16.5).

9 Checklist prior to diving



This chapter contains a complete checklist for the JJ-CCR Rebreather prior to a dive. It is essential that the diver run through this checklist prior to every dive.

- If the diver does not run through the checklist then there is a possibility of entering the water with equipment that is not suitable for diving, which can result in severe risks to health.

9.1 Preparations on land



Step	Description
1	Do I feel, healthy, well and calm? If not, it is best not to dive!
2	Is the soda lime canister filled with new soda lime that has never been used? Soda lime that has already been used must never be used for another dive.
3	Analyse the contents of the diluent and oxygen tanks. Also check whether sufficient pressure is present for the planned dive.
4	Never forget to carry an adequate Bailout system for the dive. When calculating the required Bailout system, always assume the worst case scenarios. You can never take too much Bailout gas with you!
5	Secure the tanks (O ₂ and diluent) to the Rebreather.
6	Place the lid with the soda lime canister into the aluminium housing.
7	Connect all hoses. Take care to ensure that the O-rings are clean. Always check that the DSV shutter valves are functioning correctly in the breathing hose.
8	Open both tank valves and check the tank pressure.
9	Check the medium pressure of both first stages. The diluent must exhibit a medium pressure of 9.0 to 10.0 bar, whilst in the case of the oxygen this must be 7.0 – 7.5 bar. It is prohibited to dive using the equipment if these values are not correct!
10	Check the manual supplemental valves and ADV to ensure they are functioning correctly.
11	Check the wing inflator to ensure it is functioning correctly.
12	Check the DSV (Dive Surface Valve) to ensure it is functioning correctly.
13	Carry out a positive pressure test: Fill the circuit fully with air via the mouthpiece, until the overpressure valve of the counter lung triggers. Close the mouthpiece and wait a few minutes. Now open the mouthpiece again. If the system still contains overpressure then you will hear the gas escaping upon opening the mouthpiece.
14	Actuate the fast drain valve on the counter lung in order to ensure that it functions correctly.
15	Carry out a negative pressure test: Close both tank valves. Using the mouthpiece, generate a vacuum in the circuit. A clear sign of a vacuum is the position of the ADV membrane. Close the mouthpiece and wait. If the position of the ADV membrane does not change, the test has been successful. As soon as you open the mouthpiece again you should also hear the noise of air being drawn in.

16	Open both tank valves again.
17	Open the mouthpiece (=CC mode).
18	Switch the HUD and the controller on.
19	Calibrate the oxygen sensors with the controller and then with the HUD.
20	Check to voltage of the controller and solenoid battery.
21	Breathe for 2-3 minutes from the device, in order to check that the soda lime is functioning correctly.
22	Close the mouthpiece (OC mode).
23	Switch off the controller and the HUD.
24	Close both tank valves.

9.2 Shortly prior to diving



Step	Description
1	Open both tank valves and check the tank pressure.
2	Check the manual supplemental valves and the ADV.
3	Check the wing inflator.
4	Check the DSV (Dive Surface Valve) to ensure it is functioning correctly.
5	Carry out a positive and negative pressure test.
6	Switch the HUD and the controller on.
7	Check the setting of the low and high setpoint on the controller.
8	Open the mouthpiece and breathe for at least 2-3 minutes.

9.3 Shortly after entering the water



Step	Description
1	Carry out a bubble check within the first 6 metres of descending. Never start a deeper descent without carrying out this check.
2	Check the display on the controller and HUD.
3	Check that the equipment is correctly positioned and that everything is stored in the right place.

10 Diving



The most important rule when diving is: Always know your PPO₂ at all times! With the JJ-CCR this can be read out from the HUD and/or the controller. In order to be certain that both systems are working correctly, the diver should also check regularly to ensure that both instruments are displaying the same values. The optimum water position requiring the minimum breathing effort is at an angle of 20 - 30 degrees. This means that the head must be somewhat higher than the legs. Breathing should be deep and even at all times. In general terms, the volume in the breathing circuit should be as low as possible. Too great a volume has a negative effect on the breathing effort and buoyancy. The volume in the breathing circuit is perfect if breathing in does not quite trigger the ADV.

11 After the Dive



This chapter contains details of all steps that should be carried out with the JJ-CCR Rebreather after the dive. Please carry out these steps after every dive:

Step	Description
1	Never close the tank valves before you take off the Rebreather.
2	Switch the controller off and dry the water contacts.
3	Switch off the HUD.
4	Close both tank valves.
5	Remove the breathing hose with the DSV.
6	Remove the lid with the soda lime canister from the aluminium housing.
7	Remove the soda lime canister from the lid.
8	Leave the lid and the soda lime canister to dry.

Steps 5-8 are only necessary if the diver is planning no further dives the same day.

12 Cleaning



It is possible to carry out "quick" or "complete" cleaning of the JJ-CCR Rebreather. "Quick" cleaning is completed rapidly and can also be carried out between two dives.

12.1 "Quick" Cleaning



The following steps should be carried out for "quick" cleaning:

Step	Description
1	Remove the breathing hose with the DSV and rise it with water. Attention: Excessive water pressure must be avoided as this can damage the shutter valves.
2	Add water to the counter lung via the T-piece – ATTENTION ONLY ON THE EXHALATION SIDE. Remove the water by actuating the fast drain valve.
3	Remove the lid with the soda lime canister from the aluminium housing.
4	Remove the soda lime canister from the lid.
5	Leave the lid and the soda lime canister to dry.

12.2 “Complete” Cleaning ●●●

Complete cleaning should be carried out every day, in particular in warmer regions.

Step	Description
1	Remove the lid with the soda lime canister from the aluminium housing.
2	Remove the soda lime canister from the cap.
3	Leave the lid and the soda lime canister to dry.
4	Remove the counter lung with the breathing hose.
5	Spray a little disinfectant (e.g. JJ-CCR Clean) into the T-pieces.
6	Fill the counter lung and breathing hose with water and wait a few minutes (in accordance with the specifications for the disinfectant).
7	Empty the counter lung and breathing hose. Rinse everything once more with fresh water. The simplest way to do this is to remove the breathing hose from the counter lung and rinse both through separately.
8	Leave everything to dry overnight. The counter lungs dry best if rotated 180 degrees and hung up, so that the T-pieces point downwards.

Two short hoses are located on the lid. It is not necessary to clean these so frequently. This can be carried out after a period of a number of weeks without cause for concern. It is important that the lid is always stored such that these two hoses are able to dry out well during a dive. If necessary it is also possible to rinse the hoses out on the exhalation side using water. In order to do so, hold the lid at a slight angle so that the water can drain out directly. Never rinse the inhalation side in the same way because the oxygen sensors will be immersed in water. When carrying out complete cleaning it is naturally also possible to remove both hoses. In order to do so, remove the screw with the washer located between the two hoses. (see chapter 5.1.4)

13 Storage ●●●



When storing the JJ-CCR Rebreather it is essential to choose a dry, shady and well ventilated location. Avoid any unnecessary UV radiation. All parts of the breathing circuit must be disinfected thoroughly prior to storage, and the soda lime canister must be emptied. In order to prevent the penetration of living creatures and/or other foreign particles, the equipment must be assembled for storage. Ensure that the DSV (Dive Surface Valve) is closed. The lid with the soda lime canister must not be placed fully in the aluminium housing. The image on the left shows the correct position:

If the lid is inserted fully with the soda lime canister and remains in this position for an extended period then it is possible, in certain circumstances, that it will be necessary to apply extensive force in order to remove it.

14 Maintenance

14.1 General Care

As with all technical equipment, the JJ-CCR Rebreather should always be treated with care. General care also includes observing the maintenance intervals and regularly checking the general condition of the equipment. For example, the O-ring grease.

14.2 Maximum Service Life

If the maintenance intervals are observed, there is theoretically no given maximum service life. However, the user should be aware that rubber and plastic parts do age, and that this process is accelerated by exposure to direct sunlight. If these parts are not replaced during standard maintenance works then the following maximum service life figures apply:

Service life	Part(s)
10 years	All rubber parts – Breathing hose, mouthpiece, O-rings, etc.
10 years	Counter lungs – without outer liners
10 years	Diluent hoses – High pressure and middle pressure
5 years	Oxygen hoses – High pressure and middle pressure
1 year	Oxygen sensors (Max. operating life after installation)

Decisive here is the production year of the equipment. This information can be found on the type plate. For example “Mfg Date: 11/07” stands for the year 2011 and the month of July. If the parts have not been replaced at an earlier date during maintenance then they must be replaced no later than upon reaching this date. Exceptions here are the oxygen sensors. In this case a service life of one year applies from the date of production printed on them.

14.3 Approved care products

The following care products can be used:

Care product	Description
Grease	Molykote 111: Can be used for greasing all breathing circuit elements. ChristoLube MCG 111, Tribolube 71 or Halocarbon 25-5S: Can be used for greasing all breathing circuit elements and all parts conducting at medium pressure.
Desinfection	Virkon S, Steramine 1G or CHEMGENE HLD4L Follow the directions for use supplied with the disinfectant used.
Cleaning	For general cleaning (e.g. after use in seawater) normal tap water should be used.

14.4 Care Intervals

The following equipment care intervals must be adhered to:

14.4.1 Prior every dive

When assembling the equipment ensure in particular that all connections are free of impurities. If necessary, grease the O-rings. Do not use excessive grease. It is sufficient for the O-rings to exhibit a fine sheen. Check the correct function of the equipment in accordance with chapter 9.

- Defective and/or worn out parts must be replaced immediately.
- If the equipment is not fit for operation according to the checklist (chapter 9) then under no circumstances should it be used.

14.4.2 After every dive

Clean the equipment after every dive in accordance with chapter 12. It is necessary to carry out quick or complete cleaning depending on the situation. If the equipment has been used in salt water or chlorinated water, then it must be cleaned with fresh water before being disassembled for cleaning.

- Complete cleaning should take place shortly after the dive and no later than 12 hours afterwards.
- If used within chlorinated water (swimming pool), it has to be cleaned with fresh water right away.

14.5 Maintenance Intervals

The JJ-CCR Rebreather must be maintained in accordance with the maintenance intervals specified.

- The user is permitted to replace the O-rings for the breathing circuit, the lid, base plate, shutter valves, oxygen sensors and membrane for the ADV. The equipment must be returned to the manufacturer or an approved service centre for all other work.
- Maintenance and repairs to the solenoid, electronics and the first stage must be carried out by the manufacturer or an approved service centre exclusively.
- In the event of repairs only use original replacement parts. If other parts are used then the warranty is voided and there is a risk that a malfunction could result in injury or even death.
- The individual maintenance intervals are based on normal use. In the event of more intense use, these intervals must be reduced. It is therefore necessary to replace defective and/or worn out parts immediately, irrespective of the maintenance intervals.

14.5.1 Every 12 months



Part or Assembly	Maintenance Task
Oxygen sensors	Replace all oxygen sensors which are in use after 12 months since installation.
1 st stage diluent 1 st stage oxygen	Revision of the 1 st stage for the diluent and the 1 st stage for the oxygen.
Medium pressure hoses High pressure hoses	Check all medium and high pressure hoses
Breathing circuit	Replace all O-rings at the connections with the T-piece and ADV. This applies to the breathing hose with the DSV and the two breathing hoses from the lid.
DSV (Dive Surface Valve)	Exchange the shutter valves.

14.5.2 Every 24 months



Part or Assembly	Maintenance Task
Lid	Replace three O-rings (2 x lid seal, 1 x soda lime canister seal)
Base plate	Replace both O-rings
Diluent tank Oxygen tank	Carry out a pressure check / visual inspection of both tanks. It may be necessary to also observe the specific regulations applicable to the country of use.

14.5.3 Every 60 Months



Part or Assembly	Maintenance Task
JJ-CCR Rebreather	Return the equipment to the manufacturer or an approved service centre for a general service.

ALWAYS KNOW YOUR PO2

THIS MANUAL IS PRODUCED BY JJ-CCR ApS.

WE ARE PROUD OF BEEING THE REBREATHER
MANUFACTURER OF YOUR CHOICE!

OUR TEAM INTEND TO SUPPORT YOU AS
MUCH AS THEY CAN IN ORDER TO EXCEED
YOUR EXPECTATIONS

