

NEXTECH

Rechargeable 1W UHF Transceiver Twin Pack

DC1108



User Manual

Use of the citizen band radio service is licensed in Australia by ACMA Radiocommunications (Citizen Band Radio Stations) Class Licence and in New Zealand by MED General User Radio Licence for Citizens Band Radio. Operation is subject to conditions contained in those licences.

This set includes two 80 channel UHF transceivers, which enables you to communicate up to 6km in open areas.

Note: Please read these user instructions carefully before using the equipment and retain for future consultation!

ATTENTION!

Observe the following precautions to prevent fire, personal injury, and radio damage.

- Do not modify or attempt to adjust this radio for any reason.
- Do not expose the radio to long periods of direct sunlight, nor place it close to heating appliances.
- Do not place the radio in excessively dusty, humid, and /or wet areas, nor on unstable surfaces.
- If an abnormal odor or smoke is detected coming from the radio, switch OFF the power immediately and remove the optional battery pack from the radio, then contact the dealer.

FEATURES

- 155 Privacy Codes (50 CTCSS / 105 DCS)
- VOX function (Hands-free Transmission)
- LED Flashlight
- 10 Selectable Call Tones
- Voice Scrambler Function (Voice Encryption)
- TOT(Time-Out Timer) Setting
- Dual Watch function
- Scan Function
- Automatic Power Save
- Monitor Function
- Roger Beep Tone
- Squelch Level (Level 1-9)
- Keypad Lock
- Whisper Function
- Earpiece Mode
- Power HIGH/LOW Settings
- Speaker / Microphone Jacks
- Battery Meter / Low Battery Alert

CONTROL BUTTONS

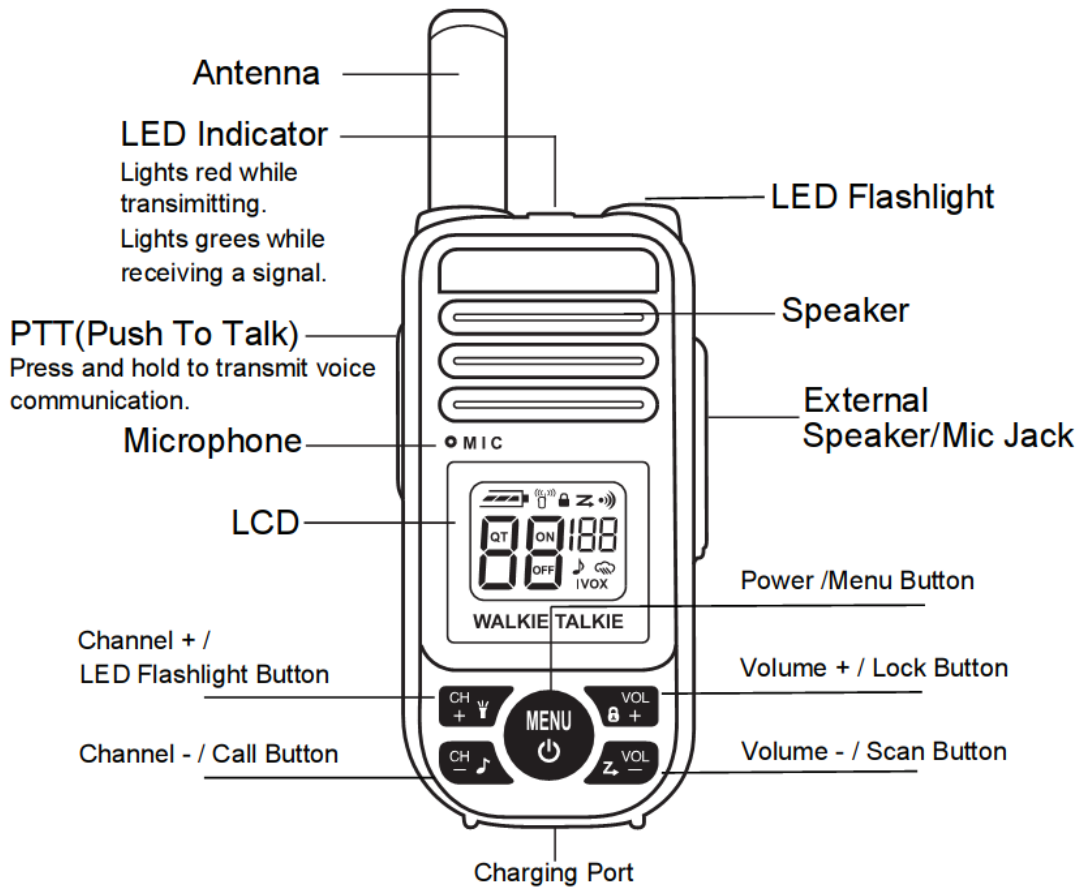

PREPARING YOUR RADIO

Battery Meter and Low Battery Alert



Indicates that the battery is fully charged.



Blinks when battery is low; charge the radio or replace batteries immediately.

Charging The Radio

1. Make sure your radio is OFF.
2. Plug the USB charge cable into the radio charging port on bottom of the radio.
3. Plug the AC adapter into an AC outlet.
4. LED indicator lights Orange: Charging; LED indicator lights Blue: Full Charged.

BASIC OPERATIONS

1. Turning Your Radio On/Off

Press and hold the  button to turn your radio ON/OFF.



2. Transmit and Receive

- (1) To make a call, press and hold the  button, then speak into the microphone using normal speaking voice. Hold the microphone approximately 1.5 inches (3 to 4 cm) from your lips.
- (2) Release the PTT button to receive.
- (3) If you set a CTCSS/DCS Code in the radio, you can receive ONLY when the CTCSS/DCS Code is SAME for the radios.

3. Adjusting The Volume

Adjust the volume by pressing the  and  buttons

4. Channel Selection

Select your desired radio channel by pressing the  and  buttons

ABOUT RANGE

Your radios are designed to give you maximum range under optimum conditions.

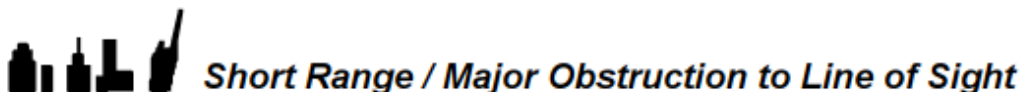
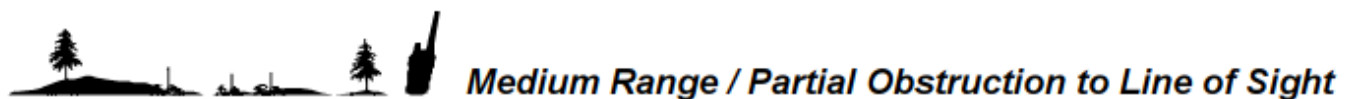

Optimum Conditions are:

- Over water
- Open rural areas without obstructions
- Flat areas where you can see the other person

To ensure you get maximum range:

- Be sure to use fresh or fully charged batteries - low batteries will cause low power conditions.
- Be sure to set your radio to use High power (Po : HI).

DISPLAY SCREEN GUIDE

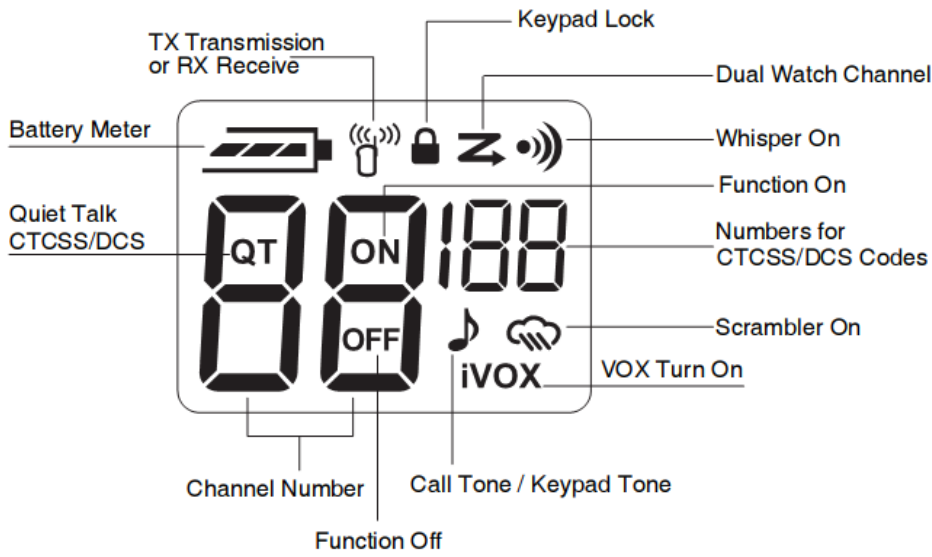

5

MENU OPTIONS

There are 14 Menu Options in this radio , you can follow below instruction to set the functions:

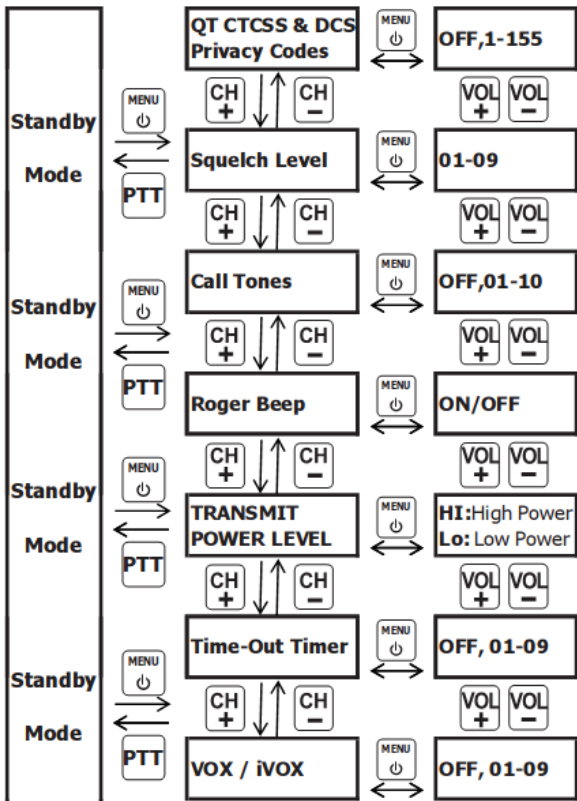

(MENU 02) Squelch Level

Squelch Level is about when the signal is strong enough to turn on the squelch. You can hear the voice from other radios only when the squelch is turned on. Higher Level makes it harder to receive the weak signals, while Lower Level will be interfered by noises and/or unwanted signal. (Default Level: 05)

To set the Squelch Level : Enter MENU 02, screen display **"Sq"**



(MENU 03) Setting and Transmitting Call Tones

Your radio can transmit different call tones to other radios in your group so you can alert them that you want to talk. You have 10 call tones from which to choose.

To set a call tone : Enter MENU 03, screen display **"CA"**



To transmit your call tone to other radios, please set radios to the same

channel and same CTCSS/DCS Code and then Press and Hold  Button.

(MENU 04) Roger Beep

You can set your radio to transmit a unique tone when you finish transmitting. It is like saying "Roger" or "Over" to let others know you are finished talking.

To turn ON/OFF the Roger Beep : Enter MENU 04, screen display **"ro"**

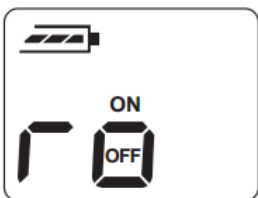

(MENU 05) Transmit (TX) Power Level Selection

To set the Transmit Power Level: Enter MENU 05, screen display **"Po"**



HI=High Power Lo=Low Power

Note : For some countries, the Power Level Selection is Disabled

(MENU 06) Time-Out Timer (TOT)

The purpose of the Time-out Timer is to prevent any caller from using a channel for an extended period of time.

If you continuously transmit for a period of time that exceeds the programmed time set by your dealer (**default is 60 seconds**), the radio will stop transmitting and an alert tone will sound.

To stop the tone, release the PTT switch.

To set the CTCSS/DCS code : Enter MENU 06, screen display **"to"**

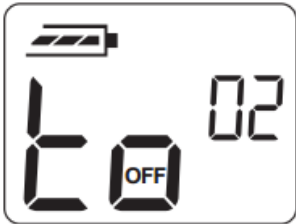

OFF = Turn Off TOT function 01 = 30s
02=60s 03=90s 04=120s 05= 150s
06=180s 07=210s 08=240s 09=270s

(MENU 07) Voice Operated Transmission (VOX)

You can use the VOX feature to transmit hands-free. Once VOX is turned on, the radio detects your voice and transmits when you speak into the internal microphone.

To set the VOX Level: : Enter MENU 07, screen display **"iVOX"**



OFF = Turn Off VOX/iVOX
9 = High Sensitivity for quiet environments
5 = Medium Sensitivity for most environments
1 = Low Sensitivity for noisy environments

Your radio have **9 VOX Sensitivity Levels** , adjusting the radio's sensitivity level helps minimize the possibility of unintended noises triggering a transmission and helps the radio pick up soft voices.

(MENU 08) Keypad Beep

You may enable or disable the speaker key tones. You will hear the key tone each time a button is pushed.

To turn ON/OFF the Keypad Beep : Enter MENU 08, screen display **"bp"**

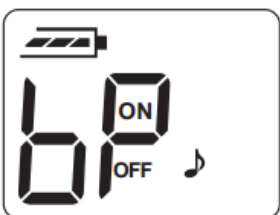

(MENU 09) Whisper Function

Your radio has a WHISPER function, to enable the user to transmit a high sound level even if he is whispering on the microphone.

To turn ON/OFF the WHISPER function : Enter MENU 09, screen display **"UI"**

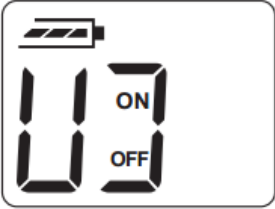

When you turn **WHISPER** on,  icon will show in the screen.

Note : The WHISPER function is recommended for use with headsets for optimum performance

(MENU 10) Optional Functions

Your radio has **Voice Comander** and **Voice Scrambler (Encryption)** function.

The Voice Comander Function is used to reduce background noise and enhance audio clarity, especially in long range communication.

The Voice inversion Scrambler function is an audio encryption process to provide a confidential communication. The radios at same frequency without Correct Scrambler ID will receive only disordered noises.

To select Voice Comander or Voice Scrambler function : Enter MENU 10, screen display **"OP"**



OFF = Turn Off Optional Function

SC = Voice Scrambler

CO = Voice Comander

When you Select and turn **Scrambler** on,  icon will show in the screen.

(MENU 11) Voice Scrambler Group ID

When you turn on Voice Scrambler function, you will need to set a Scrambler ID to encrypt your radio.

To set Voice Scrambler Group ID : Enter MENU 11, screen display **"SC"**



01-08 = Scrambler Group ID

Note : ONLY Radios with SAME Scrambler ID can normally talk with each other.

REMARK:

To communicate with radios that do not have Voice Scrambler function, you must turn off the Scrambler function in Menu 10.

(MENU 12) Earpiece/Headset Function

Your radio has a Earpiece/Headset function, to enable the user to have better sound when using a Earpiece/Headset.

To turn ON/OFF the Earpiece function : Enter MENU 12, screen display **"EP"**



(MENU 13) Monitor Function

You can use the Monitor function to listen to weak signals that you cannot hear during normal operation.

To turn ON/OFF the Monitor function : Enter MENU 13, screen display **"no"**

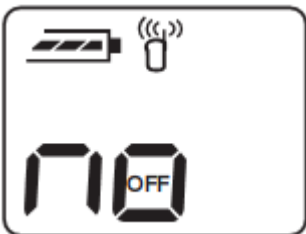

(MENU 14) Dual Watch Function

Enables your radio to scan the current channel and another selected channel alternately.

To set another channel and start Dual Watch: Enter MENU 14, screen display **"CH"**



OFF = Turn Off Dual Watch Function
01 - XX = Dual Watch Channel Number
Note : XX means the total channel numbers of your radio.

When you set a Channel as Dual Watch Channel,  icon will show in the channel you selected.

Then DUAL WATCH function is on and the radio will start to scan both the current channel/code and the selected channel/code and stop on any active channel.

When you press the PTT button to transmit on an active channel, the scanning function will stop and remain on the active channel for 10 seconds before resuming scan when the PTT button is no longer pressed.

SPECIAL FUNCTIONS SHORTCUT OPERATION

1. LED Flashlight Function

Press and Hold  button to Turn On / Off the LED Flashlight ;

2. Keypad Lock Function

To avoid accidentally changing your radio settings, you can lock the keypad of your radio:

Press and hold  Button until  displays.

To unlock the radio, press and hold  until is  no longer displayed

3. Scan Function

Channel Scan Mode Enables your radio to scan for active channels.

Press and hold  Button to Turn On the Channel Scan Function.

When activity channel is detected, your radio lands (stays) on that channel (for 2 seconds).

To transmit on that channel, press the PTT button.

When activity on the landed channel ends, your radio continues scanning other channels.

To stop scanning, Press and hold  Button to exit Scan.

4. Automatic Power Save

For better battery life, your radio is designed to switch to Power Save mode when there has been no transmissions after 3 seconds. The radio can receive transmissions in this mode.

TROUBLE SHOOTING

Troubles	Solution
No Power Supply The working time shorten, even the battery is fully charged.	1. The battery has been exhausted. Replace or recharge the battery 2. The battery is installed incorrectly. Remove the battery. Replace the battery
Not able to communicate with the radios of the same group.	1. Confirm if the CTCSS/DCS in the same frequency 2. Distance is out of the talk range
The voice of another group can be heard	Change all CTCSS/DCS of the group
Other radios can not receive the TX signals or receive signals in a volume.	1. Switch the volume knob to the highest level 2. The microphone may be damaged, send it to local dealer for check.
Noise is always heard	The distance is out of the range. Turn on the radio in nearer range and try again

Channels

Channel	Frequency	Use
Channel 1	476.4250	Duplex – Repeater Output
Channel 2	476.4500	Duplex – Repeater Output
Channel 3	476.4750	Duplex – Repeater Output
Channel 4	476.5000	Duplex – Repeater Output
Channel 5	476.5250	Duplex – Repeater Output (Emergency use only)
Channel 6	476.5500	Duplex – Repeater Output
Channel 7	476.5750	Duplex – Repeater Output
Channel 8	476.6000	Duplex – Repeater Output
Channel 9	476.6250	Simplex
Channel 10	476.6500	Simplex 4WD Drivers – Convoy, Clubs & National Parks
Channel 11	476.6750	Simplex Call Channel
Channel 12	476.7000	Simplex

Channel 13	476.7250	Simplex
Channel 14	476.7500	Simplex
Channel 15	476.7750	Simplex
Channel 16	476.8000	Simplex
Channel 17	476.8250	Simplex
Channel 18	476.8500	Simplex Caravan & Campers Convoy Channel
Channel 19	476.8750	Simplex
Channel 20	476.9000	Simplex
Channel 21	476.9250	Simplex
Channel 22	476.9500	Data Only (No Voice – No Packet)
Channel 23	476.9750	Data Only (No Voice – No Packet)
Channel 24	477.0000	Simplex
Channel 26	477.0500	Simplex
Channel 27	477.0750	Simplex
Channel 28	477.1000	Simplex
Channel 29	477.1250	Simplex Pacific Hwy (NSW) & Bruce Hwy (Qld) Road Channel
Channel 30	477.1500	Simplex UHF CB Broadcasts
Channel 31	477.1750	Repeater Input
Channel 32	477.2000	Repeater Input
Channel 33	477.2250	Repeater Input
Channel 34	477.2500	Repeater Input
Channel 35	477.2750	Repeater Input (Emergency Use Only)
Channel 36	477.3000	Repeater Input
Channel 37	477.3250	Repeater Input
Channel 38	477.3500	Repeater Input
Channel 39	477.3750	Simplex
Channel 40	477.4000	Simplex Highway Channel
Channel 41	476.4375	Duplex – Repeater Output
Channel 42	476.4625	Duplex – Repeater Output
Channel 43	476.4875	Duplex – Repeater Output
Channel 44	476.5125	Duplex – Repeater Output
Channel 45	476.5375	Duplex – Repeater Output
Channel 46	476.5625	Duplex – Repeater Output
Channel 47	476.5875	Duplex – Repeater Output
Channel 48	476.6125	Duplex – Repeater Output
Channel 49	476.6375	Simplex

Channel 50	476.6625	Simplex
Channel 51	476.6875	Simplex
Channel 52	476.7125	Simplex
Channel 53	476.7375	Simplex
Channel 54	476.7625	Simplex
Channel 55	476.7875	Simplex
Channel 56	476.8125	Simplex
Channel 57	476.8375	Simplex
Channel 58	476.8625	Simplex
Channel 59	476.8875	Simplex
Channel 60	476.9125	Simplex
Channel 61		Reserved for Future Expansion
Channel 62		Reserved for Future Expansion
Channel 63		Reserved for Future Expansion
Channel 64	477.0125	Simplex
Channel 65	477.0375	Simplex
Channel 66	477.0625	Simplex
Channel 67	477.0875	Simplex
Channel 68	477.1125	Simplex
Channel 69	477.1375	Simplex
Channel 70	477.1625	Simplex

LIST OF CTCSS/DCS CODES

50 Groups CTCSS CODE (Hz)

NO.	CODE	NO.	CODE	NO.	CODE	NO.	CODE
1	67.0	14	107.2	27	167.9	144	69.3
2	71.9	15	110.9	28	173.8	145	159.8
3	74.4	16	114.8	29	179.9	146	165.5
4	77.0	17	118.8	30	186.2	147	171.3
5	79.7	18	123.0	31	192.8	148	177.3
6	82.5	19	127.3	32	203.5	149	183.5
7	85.4	20	131.8	33	210.7	150	189.9
8	88.5	21	136.5	34	218.1	151	196.6
9	91.5	22	141.3	35	225.7	152	199.5
10	94.8	23	146.2	36	233.6	153	206.5
11	97.4	24	151.4	37	241.8	154	229.1
12	100.0	25	156.7	38	250.3	155	254.1
13	103.5	26	162.2				

105 Groups DCS CODE

NO.	CODE	NO.	CODE	NO.	CODE	NO.	CODE	NO.	CODE
39	023	60	143	81	315	102	532	123	053
40	025	61	152	82	331	103	546	124	122
41	026	62	155	83	343	104	565	125	145
42	031	63	156	84	346	105	606	126	212
43	032	64	162	85	351	106	612	127	225
44	043	65	165	86	364	107	624	128	246
45	047	66	172	87	365	108	627	129	252
46	051	67	174	88	371	109	631	130	255
47	054	68	205	89	411	110	632	131	266
48	065	69	223	90	412	111	654	132	274
49	071	70	226	91	413	112	662	133	325
50	072	71	243	92	423	113	664	134	332
51	073	72	244	93	431	114	703	135	356
52	074	73	245	94	432	115	712	136	446
53	114	74	251	95	445	116	723	137	452
54	115	75	261	96	464	117	731	138	454
55	116	76	263	97	465	118	732	139	455
56	125	77	265	98	466	119	734	140	462
57	131	78	271	99	503	120	743	141	523
58	132	79	306	100	506	121	754	142	526
59	134	80	311	101	516	122	036	143	645

Distributed by:

TechBrands by Electus Distribution Pty. Ltd.

320 Victoria Rd, Rydalmere NSW 2116 Australia

Ph: 1300 738 555 Int'l: +61 2 8832 3200 Fax: 1300 738 500

www.techbrands.com

Made in China