

MBHU

Masonry Beam Face-Mount Hanger

The MBHU beam hanger provides a face-mounted solution for connecting beams to masonry or concrete walls. A non-welded, one-piece connector, the MBHU is suitable for solid sawn and engineered wood beams as well as trusses. Installation is simplified because the Titen HD® heavy-duty screw anchor and Strong-Drive® SDS Heavy-Duty Connector screws are included with the hanger. Since the Titen HD anchor is installed after the wall is built, locating the anchor in the right spot is easier than with cast-in-place bolts.

Material: 10 gauge

Finish: Galvanized; **available in stainless steel**

Installation:

- Use all specified fasteners (included).
- Attach hanger to a concrete or grout-filled CMU wall using Titen HD anchors. Note the following:
 - Drill holes using drill bits equal in diameter to the specified Titen HD anchor.
 - Holes shall be drilled $\frac{1}{2}$ " deeper than the specified Titen HD length (i.e. $5\frac{1}{2}$ " for a 5" long Titen HD anchor).
 - Caution: Oversized holes in the base material will reduce or eliminate the mechanical interlock of the threads with the base material and will reduce the anchor's load capacity.
- Carbon-steel Titen HD is not recommended for exposed exterior applications.
- Provide moisture barrier between beam and wall per jurisdictional requirements.

Codes: See p. 13 for Code Reference Key Chart

Web Applications: Visit app.strongtie.com/hs to access our Hanger Selector web application.

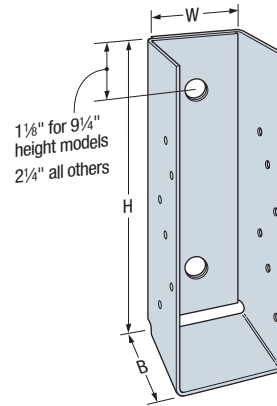

MBHU

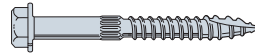

$\frac{1}{4}$ " x $2\frac{1}{2}$ " Strong-Drive SDS Heavy-Duty Connector Screw

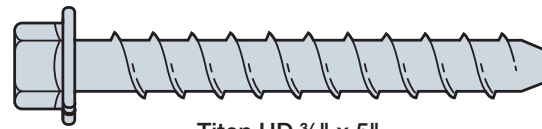

Titen HD $\frac{3}{4}$ " x 5" Screw Anchor

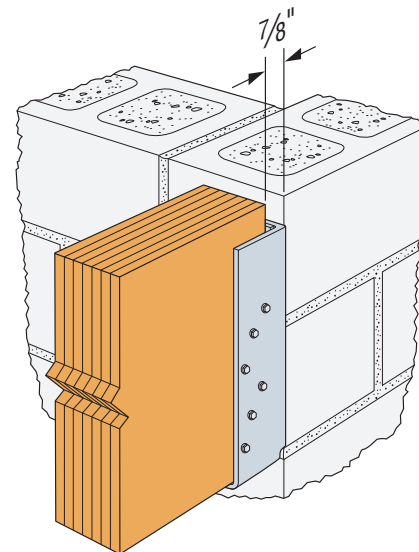

Typical MBHU Installation

These products are available with additional corrosion protection. For more information, see p. 16.

For stainless-steel fasteners, see p. 23.

Model No.	Dimensions (in.)	
	Width (W)	Height (H)
MBHU3.56/9.25KT	$3\frac{3}{8}$	$9\frac{1}{4}$
MBHU3.56/11.25KT	$3\frac{3}{8}$	$11\frac{1}{4}$
MBHU3.56/11.88KT	$3\frac{3}{8}$	$11\frac{7}{8}$
MBHU3.56/14KT	$3\frac{3}{8}$	14
MBHU3.56/16KT	$3\frac{3}{8}$	16
MBHU3.56/18KT	$3\frac{3}{8}$	18
MBHU5.50/9.25KT	$5\frac{1}{2}$	$9\frac{1}{4}$
MBHU5.50/11.25KT	$5\frac{1}{2}$	$11\frac{1}{4}$
MBHU5.50/11.88KT	$5\frac{1}{2}$	$11\frac{7}{8}$
MBHU5.50/14KT	$5\frac{1}{2}$	14
MBHU5.50/16KT	$5\frac{1}{2}$	16
MBHU5.50/18KT	$5\frac{1}{2}$	18

1. Each galvanized MBHU hanger includes (2) $\frac{3}{4}$ " x 5" Titen HD anchors and (12) $\frac{1}{4}$ " x $2\frac{1}{2}$ " Strong-Drive SDS Heavy-Duty Connector screws.
2. Each stainless-steel MBHU hanger includes (2) $\frac{3}{4}$ " x 6" Type 316 stainless-steel Titen HD anchors and (12) $\frac{1}{4}$ " x $2\frac{1}{2}$ " stainless-steel Strong-Drive SDS Heavy-Duty Connector screws.

MBHU

Masonry Beam Face-Mount Hanger (cont.)

These products are available with additional corrosion protection. For more information, see p. 16.

For stainless-steel fasteners, see p. 23.

Series Model No.	Ga.	Dimensions (in.)			Fasteners		DF/SP Allowable Loads End of Wall / Outside Corner				DF/SP Allowable Loads Away from Edge		Code Ref.
		W	H	B	GFCMU and Concrete	Joist	GFCMU		Concrete		GFCMU and Concrete		
					Titen HD® Anchors	Strong-Drive® SDS Screws	Uplift (160)	Download (100/115/125)	Uplift (160)	Download (100/115/125)	Uplift (160)	Download (100/115/125)	
SS MBHU3.56	10	3 ⁹ / ₁₆	9 ¹ / ₄ to <14	3 ¹ / ₂	(2) 3/4" x 5"	(12) 1/4" x 2 1/2"	1,610	2,440	2,715	4,190	2,210	4,005	FL
			14 to 18				1,610	2,440	2,715	4,190	3,345	6,065	
SS MBHU5.50	10	5 ¹ / ₂	9 ¹ / ₄ to <14	3 ¹ / ₂	(2) 3/4" x 5"	(12) 1/4" x 2 1/2"	1,610	2,440	2,715	4,190	2,210	4,005	
			14 to 18				2,240	3,260 ⁸	3,485	6,970	3,345	6,065	

- Uplift loads have been increased for earthquake or wind loading with no further increase allowed. Reduce where other loads govern.
- Concrete shall have a minimum compressive strength of $f'_c = 2,500$ psi.
- Grout-filled CMU (GFCMU) shall have a minimum compressive strength of $f'_m = 1,500$ psi.
- Structural composite lumber (SCL) shall have a minimum specific gravity of 0.5.
- Allowable loads only apply to installation on 8" nominal grouted CMU walls, with a minimum of one horizontal #5 rebar located in the top course.
- Products shall be installed such that Titen HD anchors are not exposed to exterior environments.
- Allowable loads are based upon the tested ultimate load with a safety factor of 3.
- Where noted in table, download listed is for end-of-wall condition. For outside-corner condition, download is 3,640 lb.
- For stainless-steel MBHU models, use 3/4"x6" Type 316 stainless steel Titen HD anchors to achieve tabulated loads.
- Fasteners:** SDS screws are Simpson Strong-Tie Strong-Drive SDS Heavy-Duty Connector screws. See pp. 23–24 for fastener information.

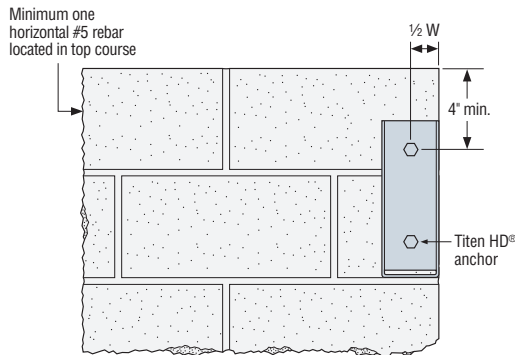

Installation at Outside Corner
(minimum load)

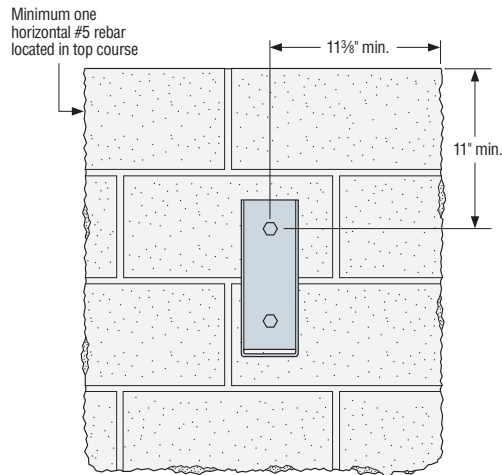

Installation Away from Edge of Wall
(maximum load)

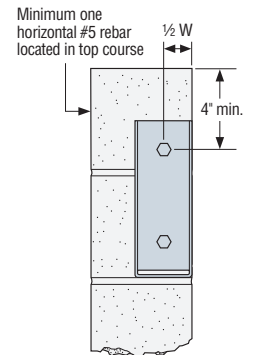

Installation on End of Wall
(minimum load)