



### CAUTION



#### CAUTION:

TO PREVENT THE RISK OF ELECTRIC SHOCK, DO NOT REMOVE ANY FRONT/BACK COVERS OR PANELS. NO USER-SERVICEABLE PARTS INSIDE. REFER SERVICING TO QUALIFIED PERSONNEL.



The lightning flash with an arrowhead symbol, within an equilateral triangle, is intended to alert the user to the presence of uninsulated "dangerous voltage" within the product's enclosure that may be of sufficient magnitude to constitute a risk of electric shock to persons.



The exclamation point within an equilateral triangle is intended to alert the user to the presence of important operating and maintenance (servicing) instructions in the literature accompanying the product.

#### WARNING:

TO REDUCE THE RISK OF FIRE OR ELECTRIC SHOCK, DO NOT EXPOSE THIS APPARATUS TO RAIN OR MOISTURE.

#### SOUND WARNING:

Avoid hearing damage by establishing safe listening volumes. Listening to this product at high volumes or for extended time periods may cause permanent hearing loss. Protect your hearing by establishing safe volumes. Start with the volume setting control at its lowest setting. Slowly increase the volume until you can hear it comfortably and clearly without distortion. Reduce the volume or stop listening if you experience ringing in your ears or any discomfort. Consult with a physician if needed.

## 380W 4-Zone 70v/100v/4-16Ω Commerical Mixer Amplifer

# AVP400 Instruction Manual

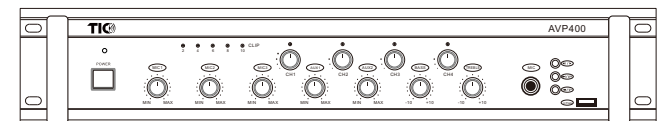

## IMPORTANT SAFETY INSTRUCTIONS:



**WARNING:** Improper use may potentially cause injury, loss of property and /or death.

1. Read these instructions.
2. Follow all instructions and heed all warnings.
3. Keep this instruction manual in a safe place for future reference.
4. Do not use this apparatus near water.
5. Clean only with a dry cloth.
6. Do not install this apparatus near any heat sources such as radiators, heat registers, stoves or other apparatus (including amplifiers) that produce heat.
7. Do not block any ventilation openings. Install this apparatus in accordance with the manufacturer's instructions.
8. Do not defeat the safety purpose of the polarized or grounding-type plug. A polarized plug has two blades with one wider than the other. A ground-type plug has two blades and a third grounding prong. The wide blade or the third prong is provided for your safety. If the provided plug does not fit into your outlet, consult an electrician for replacement of the obsolete outlet.
9. Protect the power cord from being walked on or pinched, particularly at plugs, convenience receptacles and the point where they exit from the apparatus.
10. Use only attachments and accessories specified by the manufacturer.
11. Unplug this apparatus during lightning storms or when unused for long periods of time.
12. Refer all servicing to qualified service personnel. Servicing is required when the apparatus has been damaged in any way, such as when the power supply cord or plug is damaged, liquid has been spilled or objects have fallen into the apparatus, or the apparatus had been exposed to rain or moisture, does not operate normally or has been dropped.
13. Do not expose this apparatus to dripping or splashing, and ensure that no objects filled with liquids, such as vases, are placed on the apparatus.
14. To disconnect this apparatus from the AC mains completely, disconnect the power supply cord plug from the AC receptacle.
15. The mains plug of the power supply cord shall remain readily operable.
16. Do not expose batteries to excessive heat such as sunshine, fire, or the like.
17. This is not a children's product and is not intended for use by children under 14 years old.
18. Do not place heavy objects on the apparatus.
19. Only install this apparatus in an upright position at a location that is stable and well-ventilated.
20. If any abnormal conditions are found during use, please turn off the apparatus and disconnect the power supply immediately. Contact your nearest dealer and do

## WARRANTY:

TIC offers a limited one-year full parts and labor warranty for all of our new products.

Please visit TIC's warranty page (<http://www.ticcorp.com/warranty/> ) for detail to our latest warranty policy.

TIC Audio Inc. All rights reserved. The TIC logo is a trademark of TIC Audio Inc, registered in the United States.

Features, specifications, and appearance are subject to change without notice.

For more information, please visit our website: [www.ticcorp.com](http://www.ticcorp.com).

# Table of Content

1. Safety Instructions.....	1
2. Warranty & Company Info.....	2
3. Overview.....	4
4. Front Panel.....	5
5. Rear Panel.....	6
6. Operation.....	7-9
7. Troubleshooting.....	10
8. Input/output Connection Diagram.....	11
9. System Schematics.....	12
10. Specifications.....	13
11. Dimensions.....	14

## AVP400

### Overview:

TIC AVP-400 is a commercial-grade class A/B power amplifier with constant-voltage options.

### Usage:

Designed for broadcasting audio via a constant-voltage distributed sound system or high-impedance loudspeaker system. Perfect for public address (PA) and background music.

### Features:

- 380 watt total power
- Standard 2U chassis
- 4-zone 70v output
- 70v/100v/8Ω single line output
- 3 microphones input, 2 AUX audio input, 1 audio output
- EQ with treble and bass adjustment
- Automatic thermal, overload, circuit protection
- Distortion/clipping indicators
- Built-in MP3 playback capability (via USB port)

■ Front panel

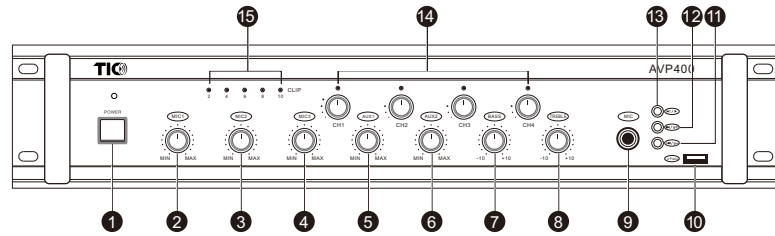

- ❶ Power switch
- ❷ Mic 1 volume control
- ❸ Mic 2 volume control
- ❹ Mic 3 volume control
- ❺ AUX 1 volume control
- ❻ AUX 2 volume control
- ❼ Bass EQ control
- ❽ Treble EQ control
- ❾ Mic 1 (priority) input
- ❿ USB port (MP3 playback)
- ⓫ Previous Track / (hold) decrease volume (MP3)
- ⓫ Next Track / (hold) increase volume (MP3)
- ⓫ Play/Pause (MP3)
- ⓫ Zone 1-4 indicator/volume control
- ⓫ Power, protection mode, signal, and clipping indicator

■ Rear Panel

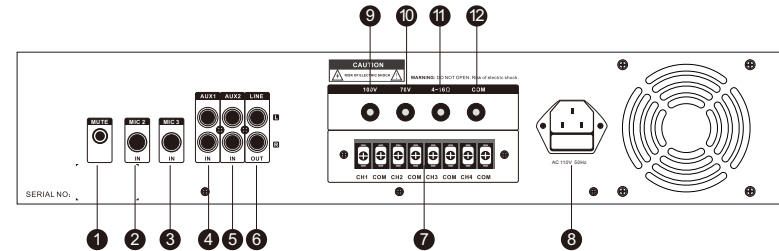

- ❶ Mute level adjustment
- ❷ Mic 2 input
- ❸ MIC3 input
- ❹ AUX 1 input
- ❺ AUX 2 input
- ❻ LINE output
- ❼ Zone 1-4 terminals
- ❽ Power cord
- ❾ 100v output terminal
- ❿ 70v output terminal
- ⓫ 4-16Ω output terminal
- ⓫ Common terminal

**Mic 1 Priority/Mute Function**

By default, Mic 1 has priority over all other inputs. When plugged in, the other inputs will automatically be muted. You can adjust the crosstalk level by turning the dial (0 - 30dB) on the rear panel.

**Operation:**

**Option 1: Single 100v output**

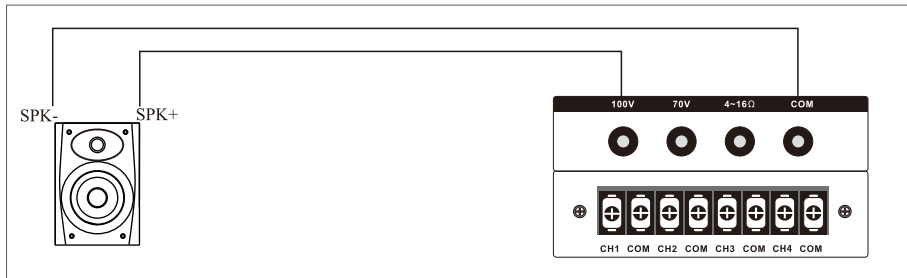

**Option 2: Single 70v output**

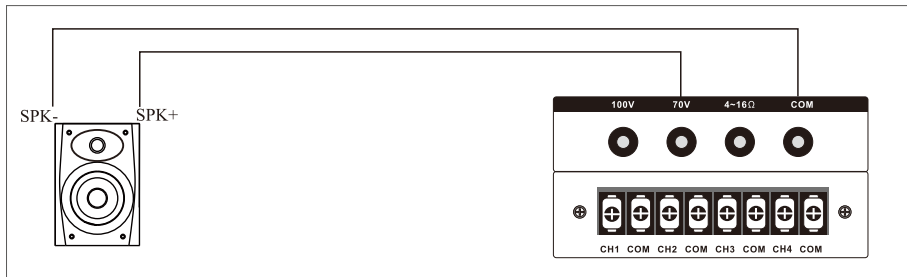

**Option 3: 4-16Ω output**

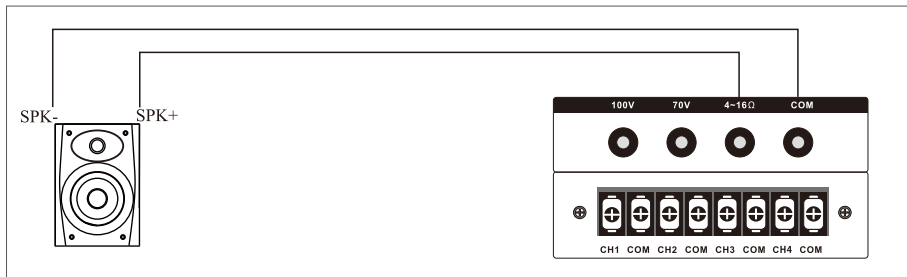

**AVP400 can be set up in one of four options. Utilizing multiple options simultaneously may cause issues and damage to the amplifier. Please ensure the polarity of speaker wires are correctly matched and connected.**

**Option 4: 4-zone 70v output (can be used in any combination of the 4 zones)**

**Zone 1 terminals**

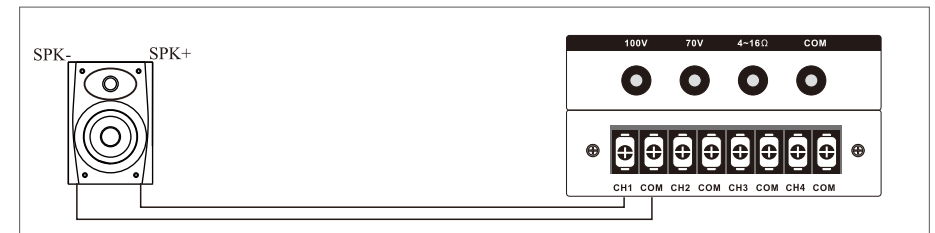

**Zone 2 terminals**

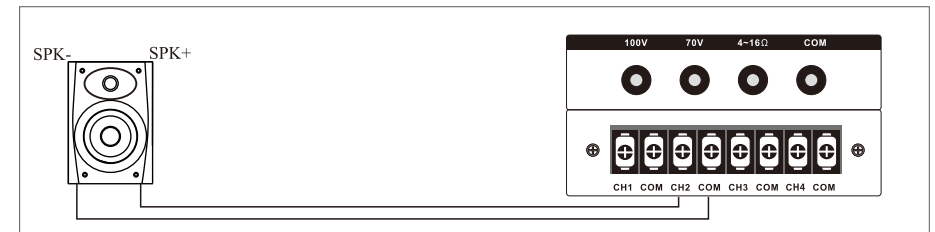

**Zone 3 terminals**

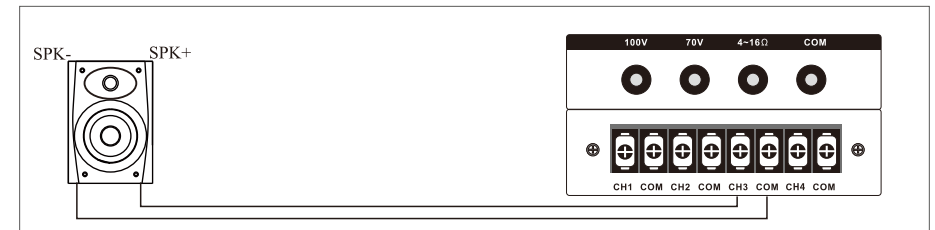

**Zone 4 terminals**

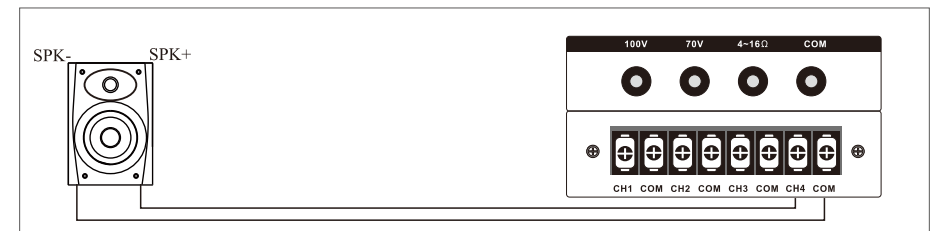

**Note:**

1. Please make sure that the power is turned off during speaker installation. When the power is on, there may be a risk of electric shock.
2. Please ensure the sum of the power and impedance load of the speakers connected does not exceed the specified range of the amplifier. Ideally, the total power load doesn't exceed 80% of the rated output power of the amplifier.

## Operation instructions:

### Step-by-Step Instruction:

#### A. Connecting loudspeakers

1. Ensure power switch is at the OFF position.
2. Connect power cord to power source outlet.
3. Determine and prepare the appropriate speaker wire (gauge, insulation type, length).
4. Connect speaker to the appropriate wiring terminals, as instructed in the previous section.
5. Turn down all volume knobs and then turn on power switch.

#### B. Audio device input

1. Turn down volume before plugging in a new input device.
2. Adjust volume to the desired level.
3. When MIC1 input is plugged in, other input channels will be automatically muted. Only plug in MIC1 when actively utilized.

#### C. Power down

1. Turn down the volume knob before turning off the amplifier.
  2. After turning off the amplifier, please wait at least 5 seconds before turning on again.
- Switching the power on and off in quick succession may cause device failure.

#### D. MP3 playback



1. The USB port has an automatic playback capability. It will automatically search the USB storage device and play any compatible MP3 tracks.
2. Press corresponding buttons to navigate playback (play/pause, next, back).
3. Hold corresponding buttons to adjust volume.

## Troubleshooting

Symptom	Cause & Solution
1. Power does not turn on.	<ol style="list-style-type: none"> <li>1. Power source is disconnected or cut.</li> <li>2. Protection mode is activated.</li> </ol>
2. No sound output.	<ol style="list-style-type: none"> <li>1. No power is connected.</li> <li>2. Fuse is blown and needs to be replaced.</li> <li>3. Volume is turned off completely.</li> <li>4. No active input.</li> <li>5. MIC1 (priority) is plugged in but inactive.</li> <li>6. USB device is plugged in but no MP3 track is found.</li> </ol>
3. Sound suddenly stops or is intermittent during playback.	<ol style="list-style-type: none"> <li>1. Protection mode is activated due to overheating. Please wait a few minutes to restart.</li> <li>2. Poor or broken wire connection.</li> </ol>
4. Volume is low.	<ol style="list-style-type: none"> <li>1. A high-impedance loudspeaker (4-16Ω) is connected to a low-impedance (70v/100v) output.</li> <li>2. MIC1 is plugged in but inactive.</li> <li>3. Volume needs to be turned up.</li> </ol>
5. Sound is distorted.	<ol style="list-style-type: none"> <li>1. Input level of microphone or external device is too high.</li> <li>2. Volume level is too high.</li> </ol>

Connection Diagram

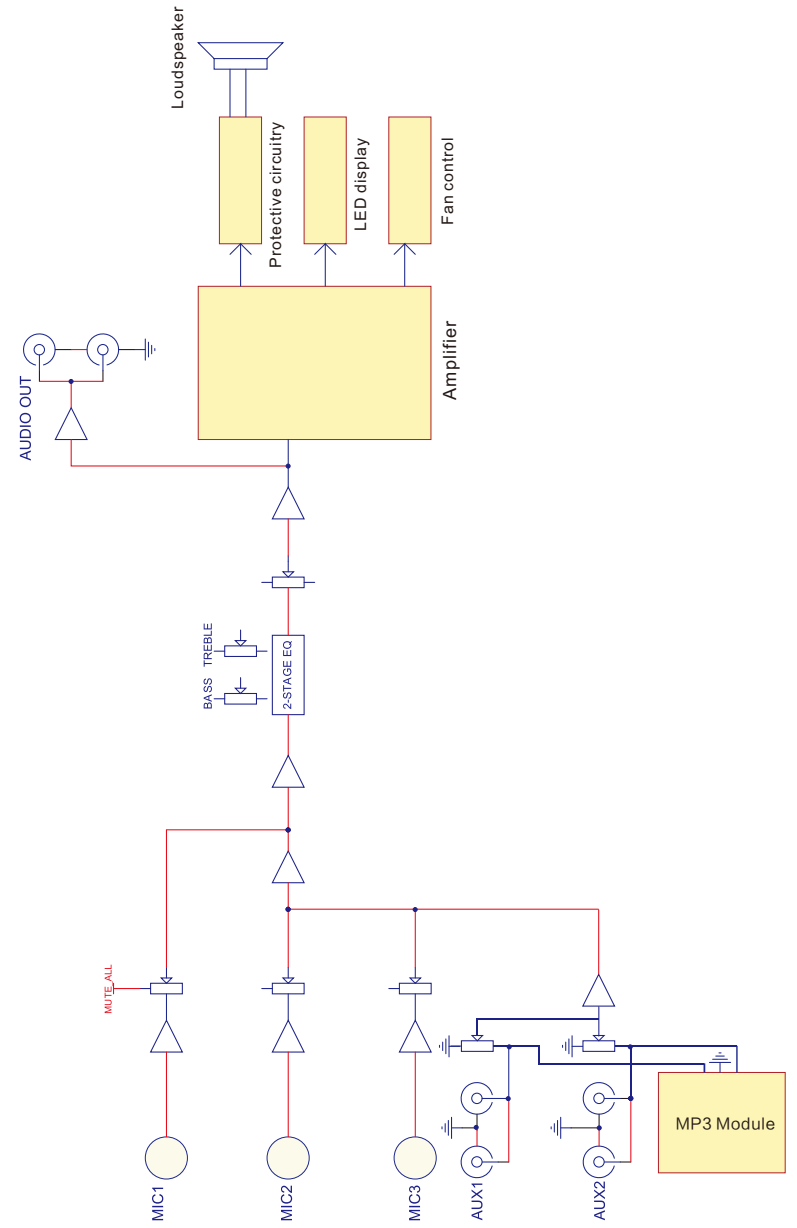
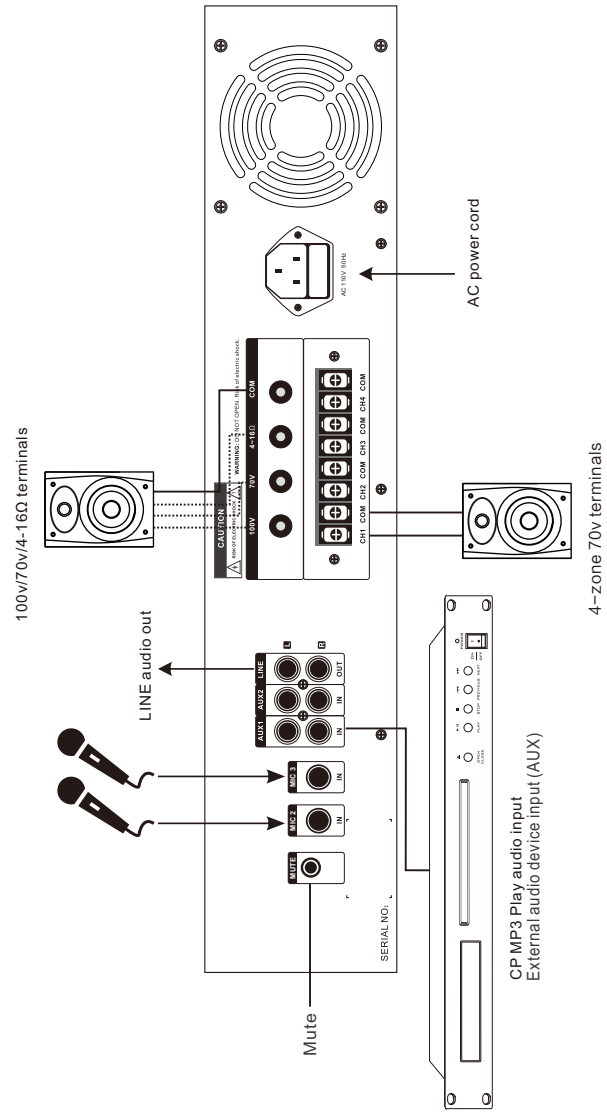

## Specifications

Model	AVP400
Output Power	380W
Output Terminals	4-zone 70v, 4-16Ω, 70v, 100v
Input Sensitivity	Mic 1-3: 5mV/600Ω via unbalanced 1/4" inputs AUX 1-2: 350mV/ 10kΩ via unbalanced RCA inputs"
AUX Output Sensitivity & Impedance	1000mV/470Ω via unbalanced RCA output
EQ	Bass: ±10dB @ 100Hz; Treble: ±10dB @ 10kHz
Frequency Response	80-16kHz
Channel Crosstalk	50dB (MIC1 takes priority over all other inputs)
Signal-to-Noise Ratio	Mic 1-3: 66dB or better AUX 1-2: 80dB or better
THD	less than 0.5% (at 1kHz, typical)
Cooling	dynamic fan cooling
Protection Modes	thermal overheating, overload, short-circuit
AC Power	100-130V/50Hz
Power Consumption	560W
Weight	25.4 pounds
Dimension	19.1" w x 15" d x 3.5" h

## Dimensions

To keep the amplifier properly ventilated, a space of at least 4" should be cleared around the machine in order to provide enough air circulation and prevent overheating.

