



THE DROP SLEEVE TOP

www.theavidseamstress.co.uk

the pattern is for personal use only
it may not be sold, reproduced
or given away

- Size 0
- Size 1
- Size 2
- Size 3
- Size 4
- Size 5
- Size 6
- Size 7
- Size 8



10 CM TEST SQUARE



LOOP CUT 1



THE DROP SLEEVE TOP

A

FRONT TOP

CUT 1 ON FOLD

seam allowances included

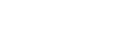

THE DROP SLEEVE TOP

B

BACK TOP

CUT 2

seam allowances included



THE DROP SLEEVE TOP

C

SLEEVE

CUT 2

seam allowances included

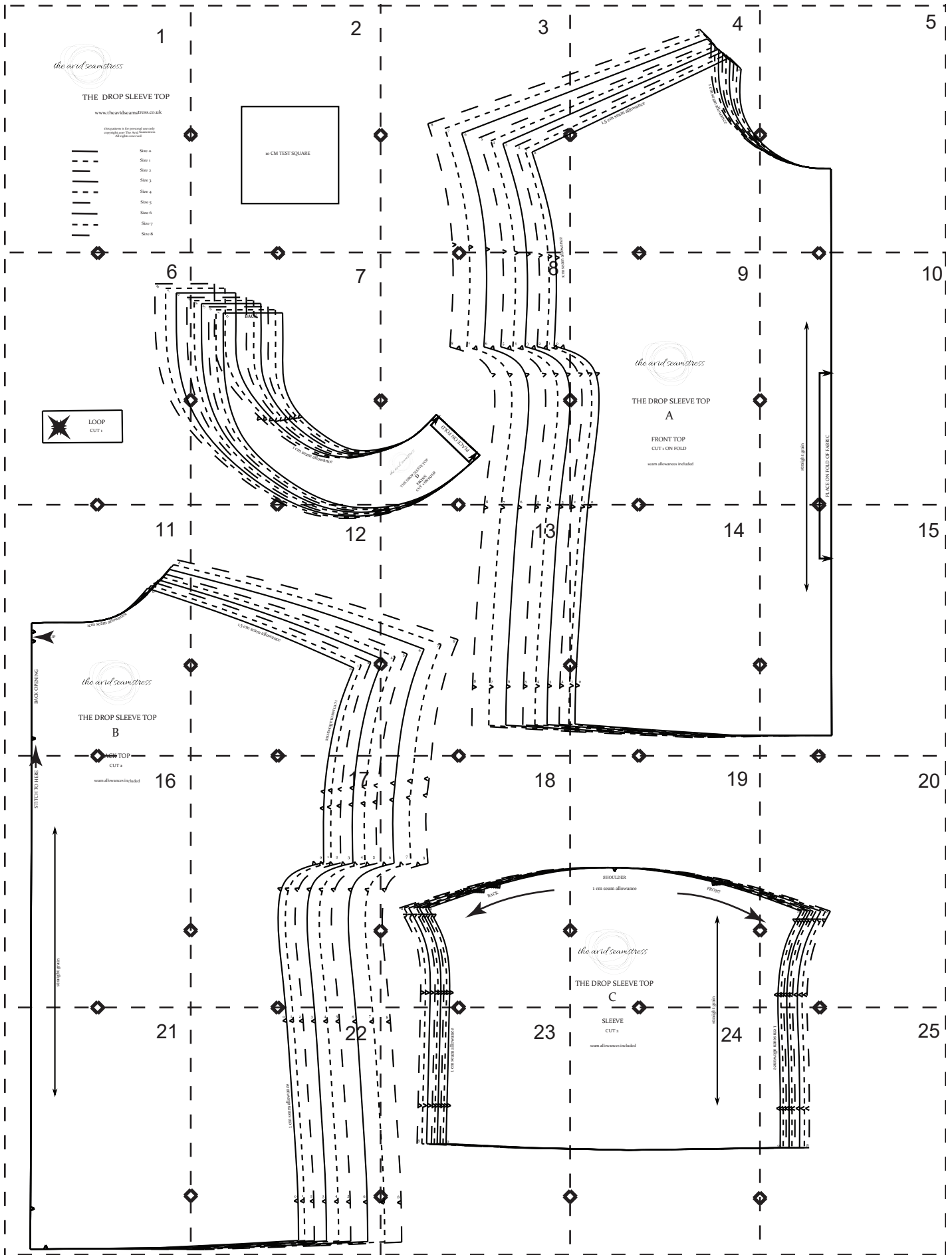

1



THE DROP SLEEVE TOP

www.theavidseamstress.co.uk

this pattern is for personal use only
copyright 2017 The Avid Seamstress
All rights reserved

—————	Size 0
.....	Size 1
- - - - -	Size 2
—————	Size 3
.....	Size 4
- - - - -	Size 5
—————	Size 6
.....	Size 7
- - - - -	Size 8

2

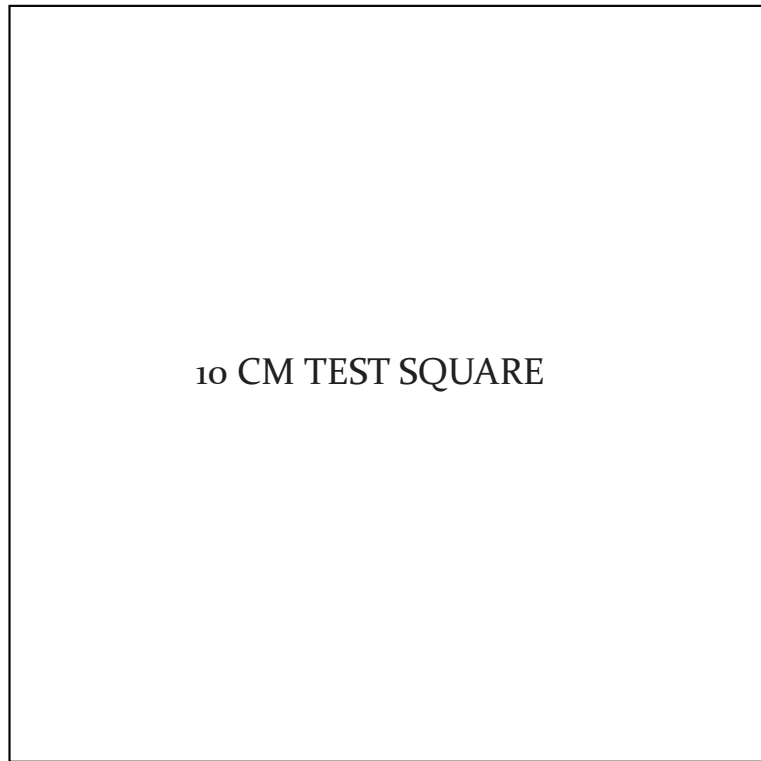

10 CM TEST SQUARE

3

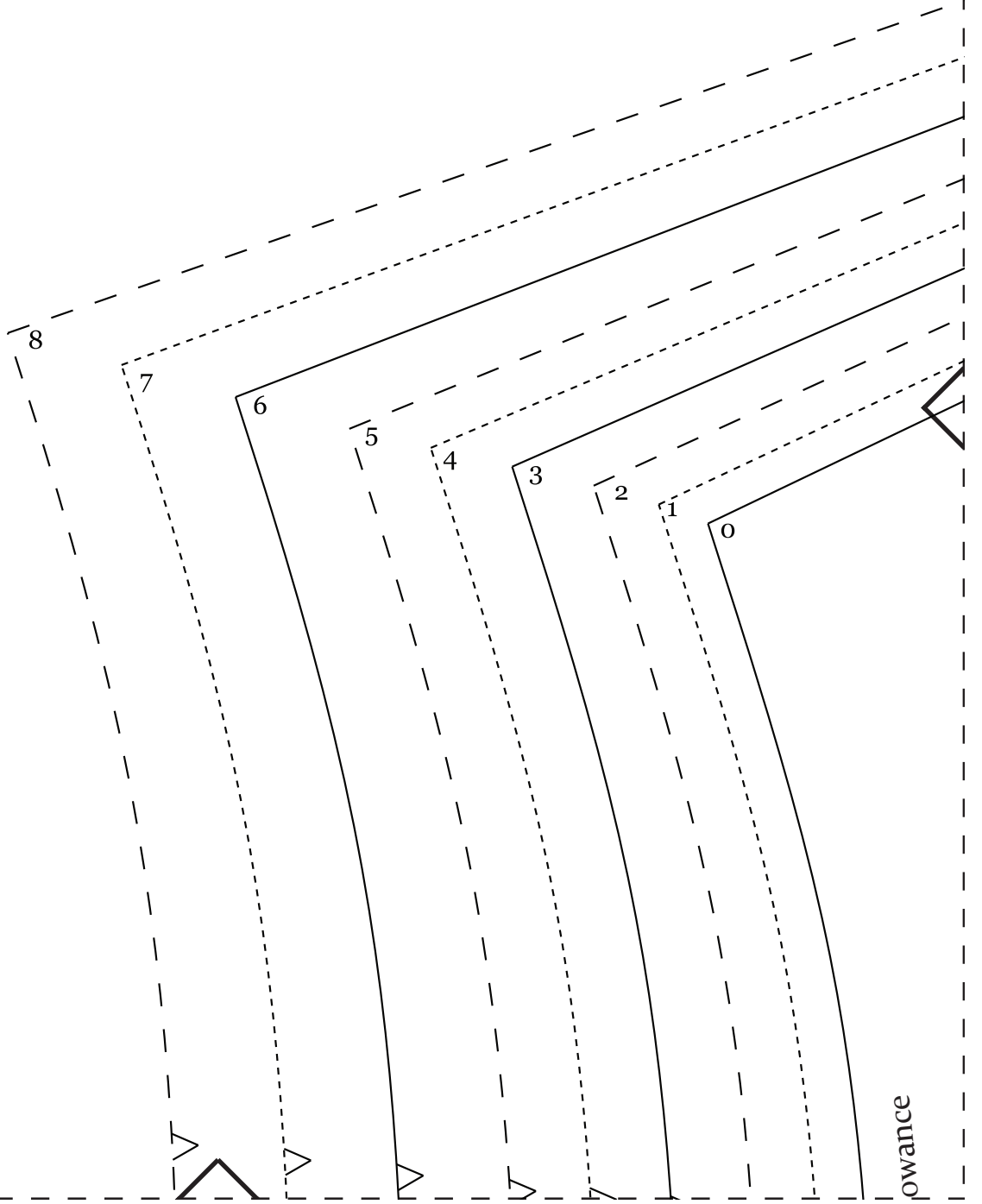

owance

4

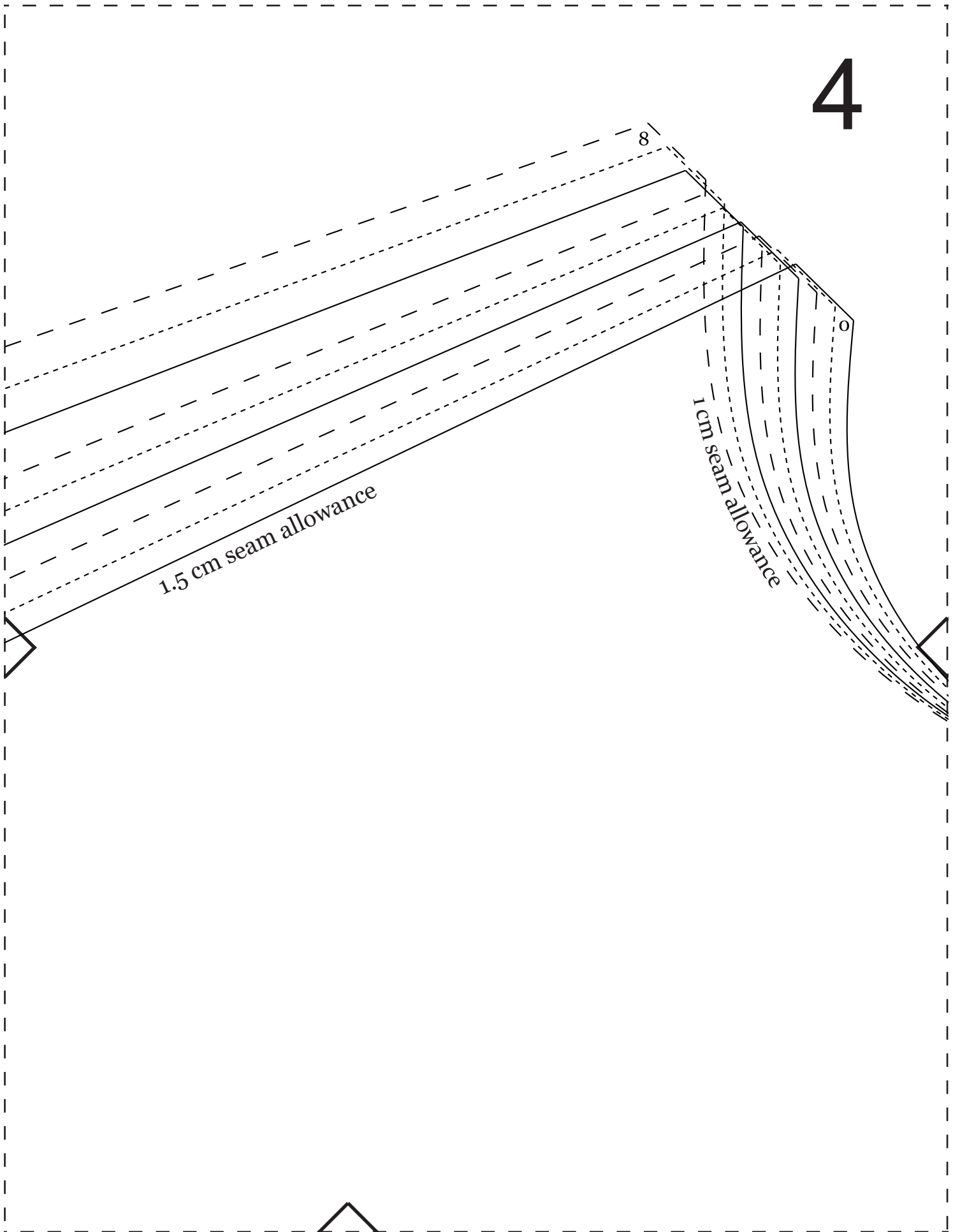

5

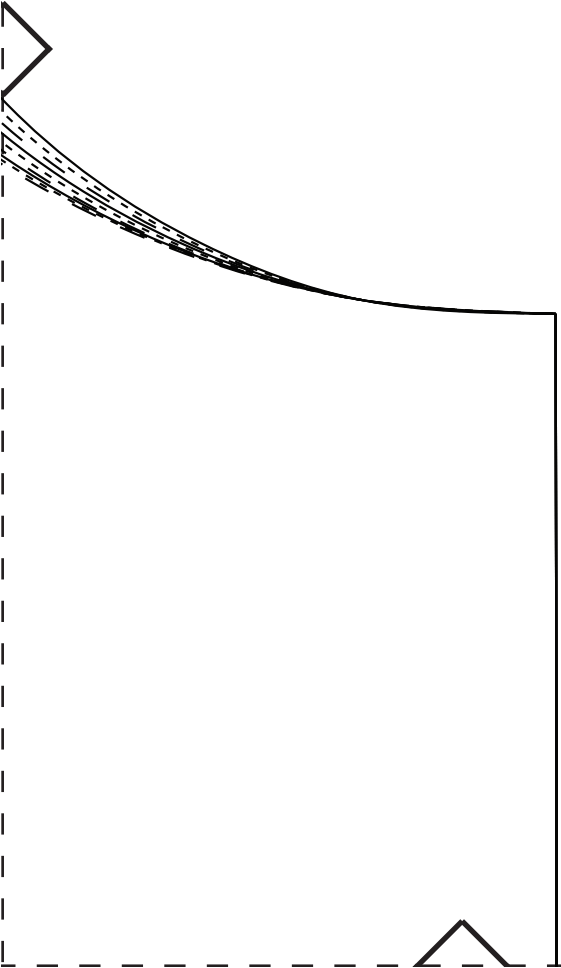

6

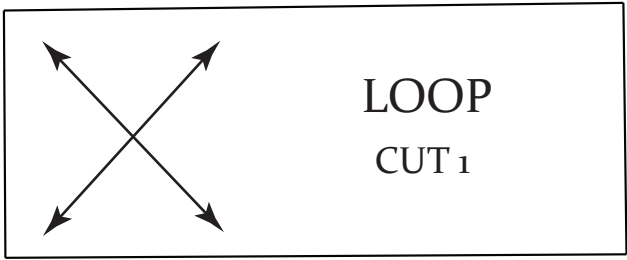
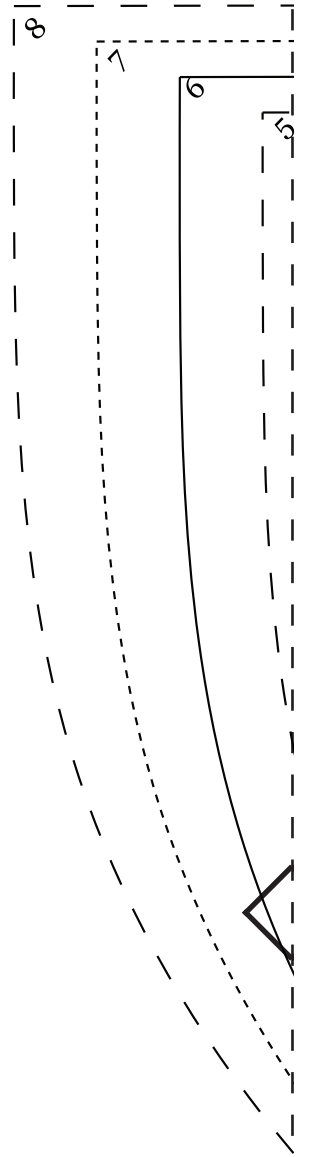

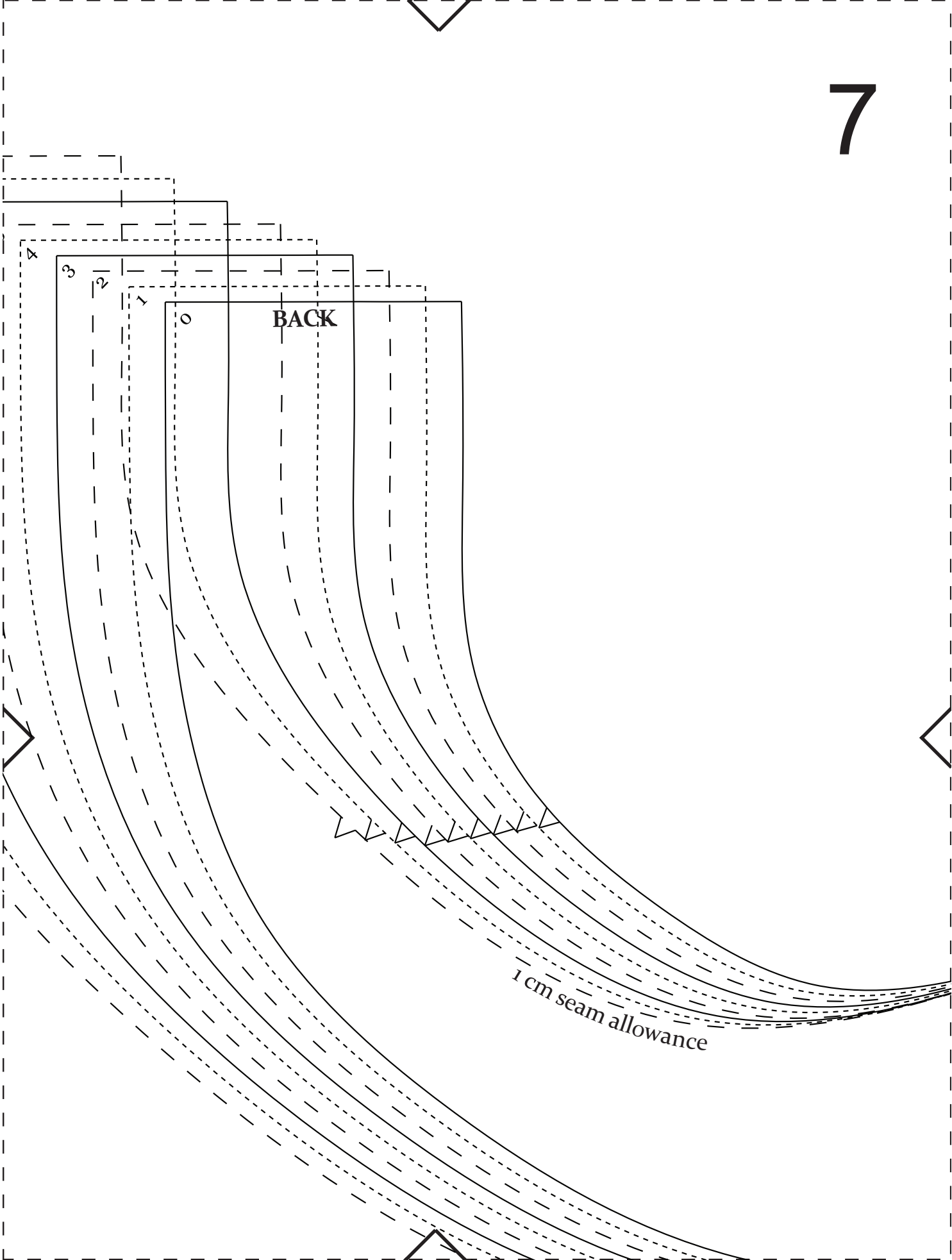

8

1cm seam all

8 7 6 5 4 3 2 1 0

8 7 6 5 4 3

PLACE ON FOLD



THE DROP SLEEVE TOP
D
FACING
CUT 1 ON FOLD

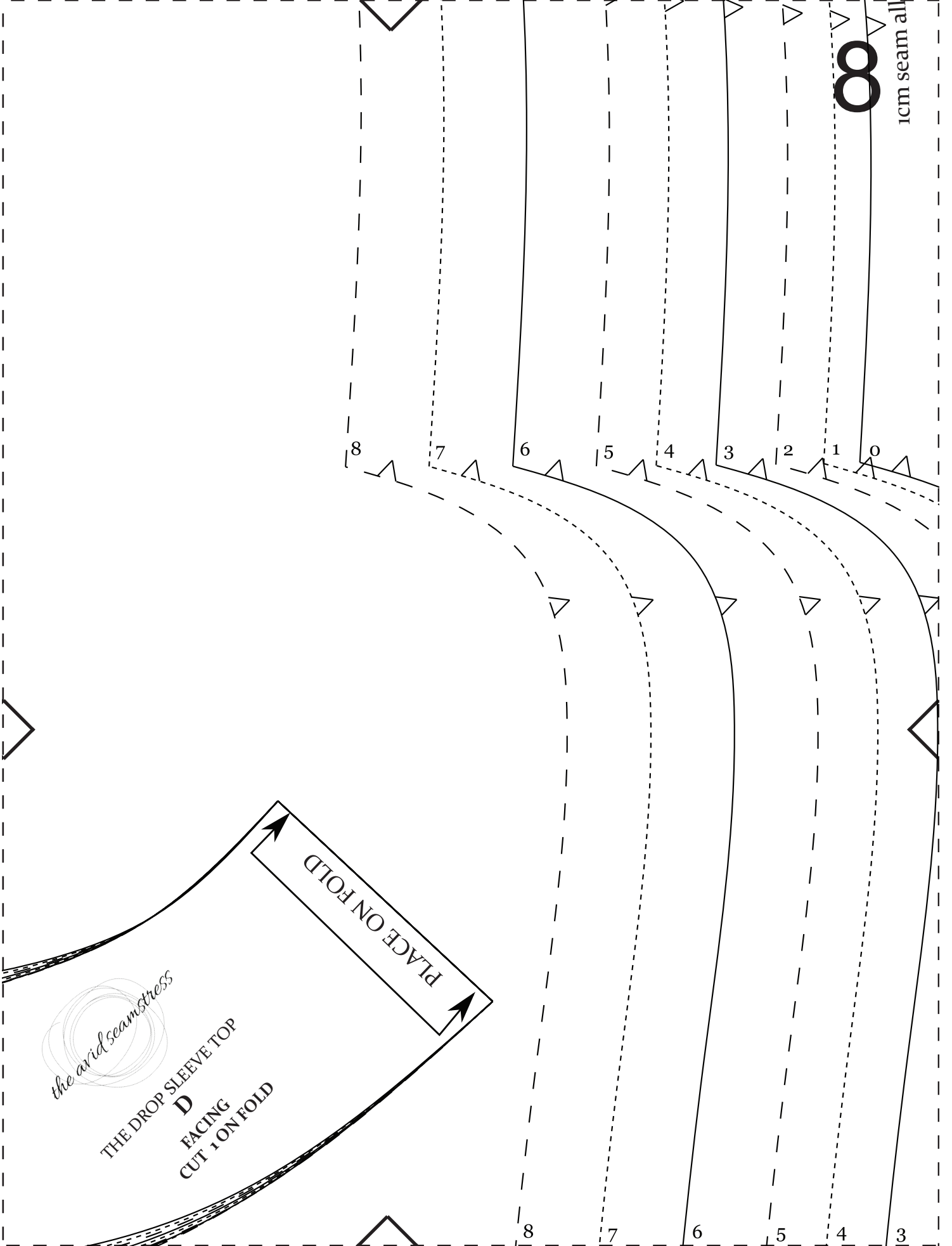

the avid seamstress

THE DROP SLEEVE TOP

A

FRONT TOP

CUT 1 ON FOLD

seam allowances included

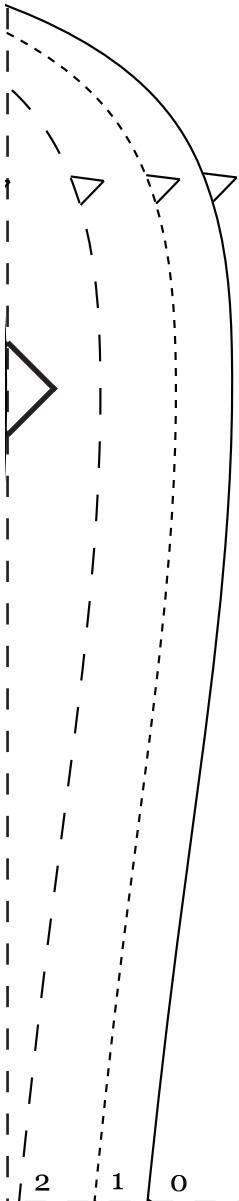

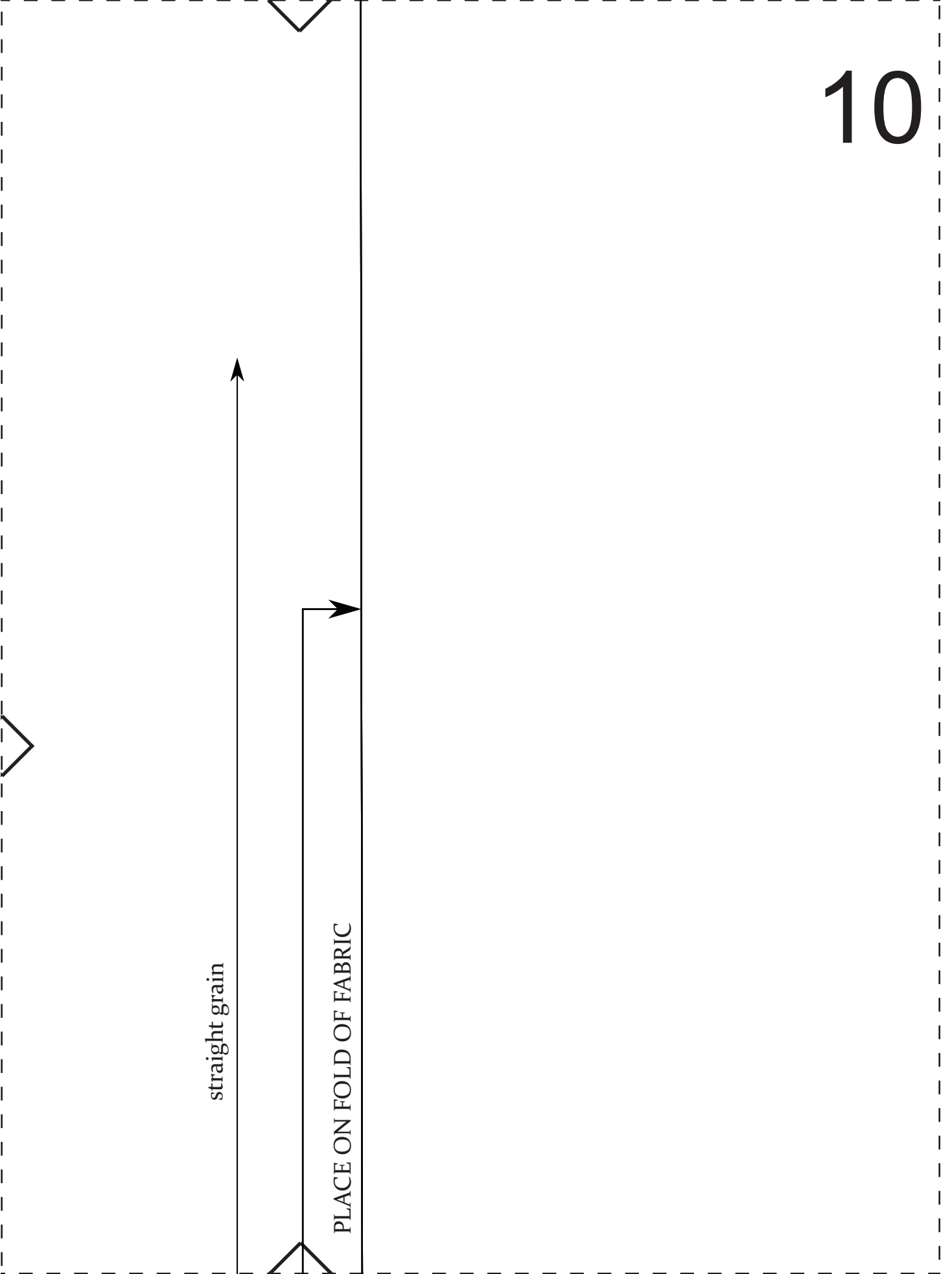

straight grain

PLACE ON FOLD OF FABRIC

10

11

1cm seam allowance

LOOP

BACK OPENING

the avid seamstress

THE DROP SLEEVE TOP

B

BACK TOP

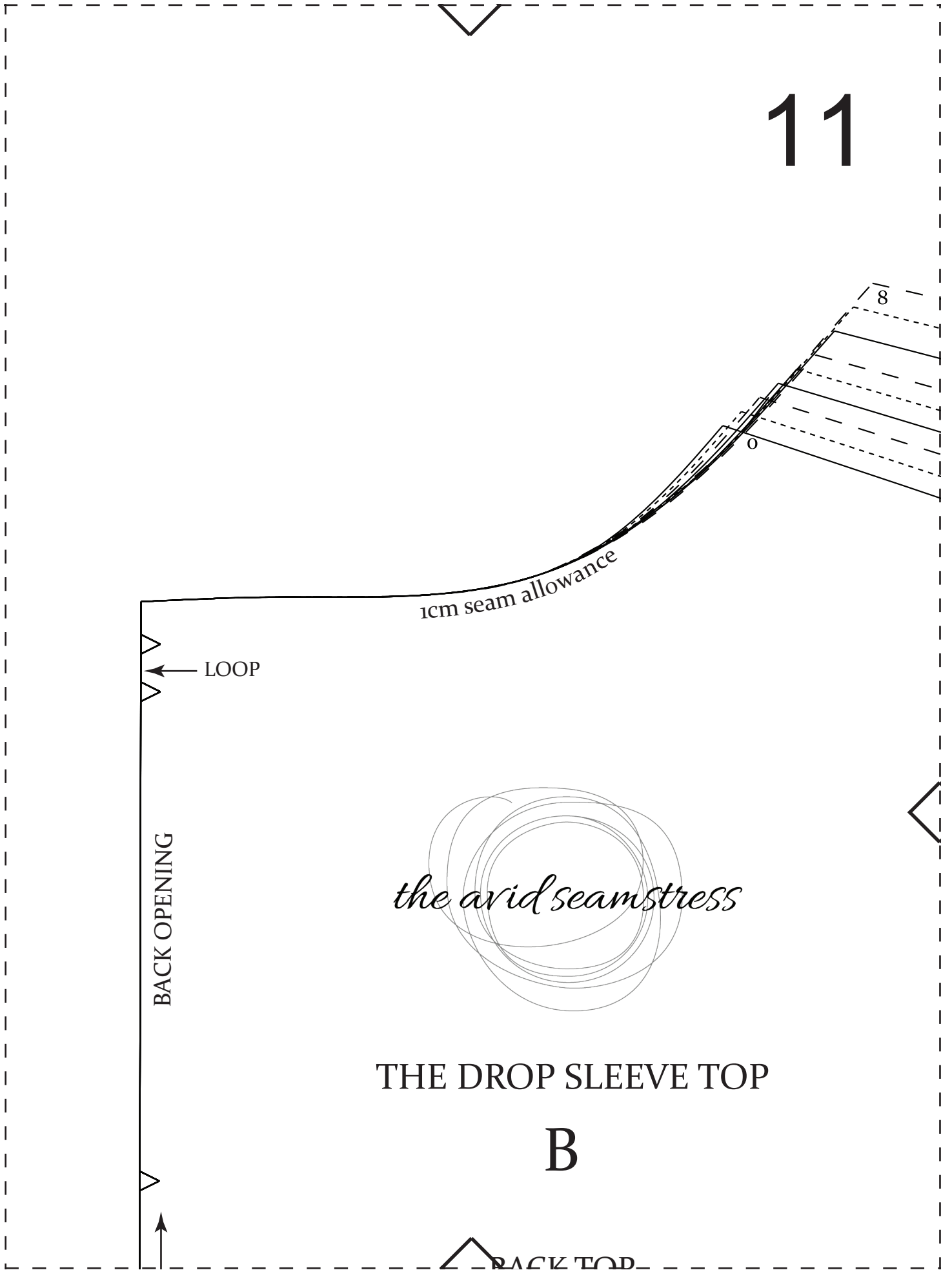

12

1.5 cm seam allowance

1 cm seam allowance

0

1

2

3

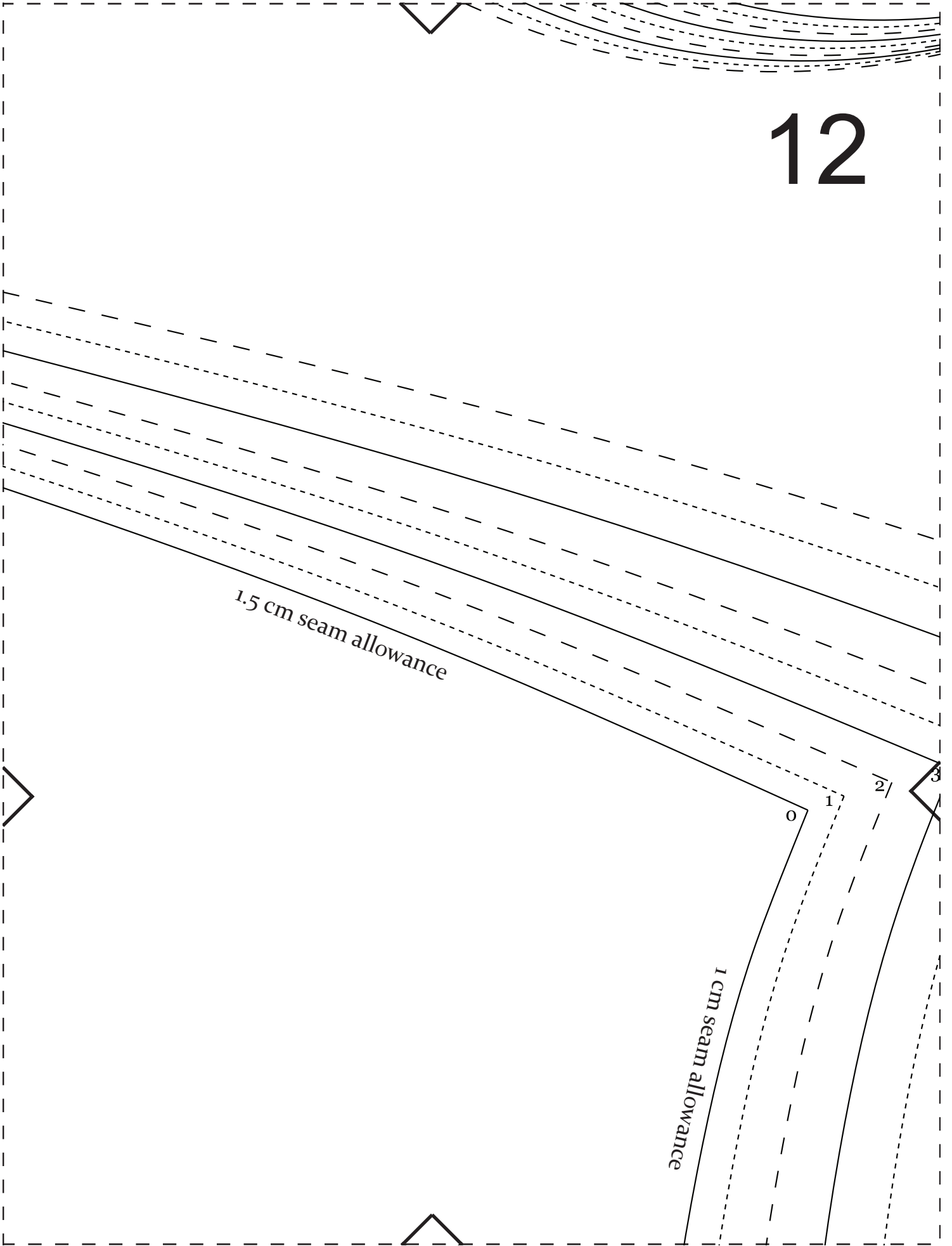

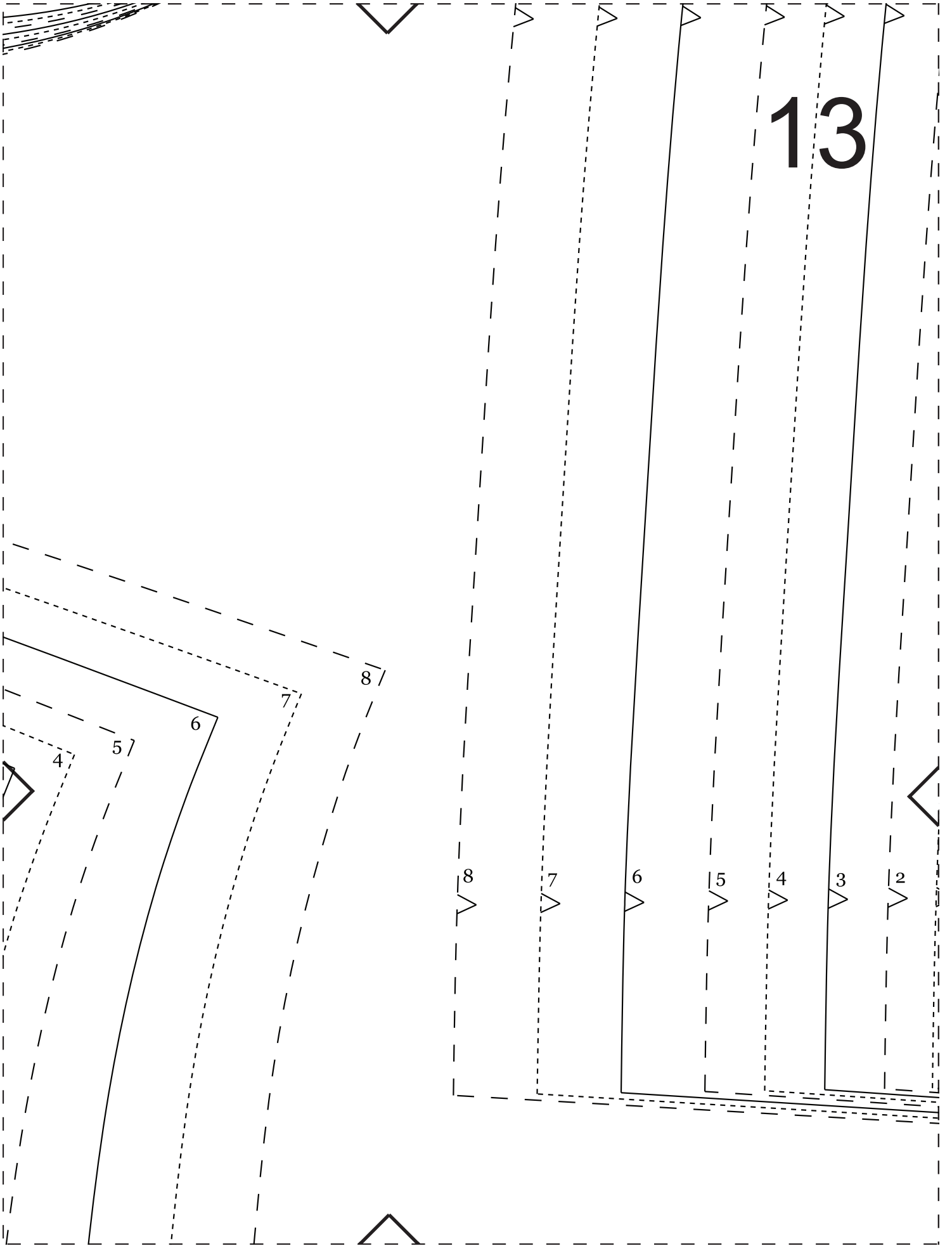

13

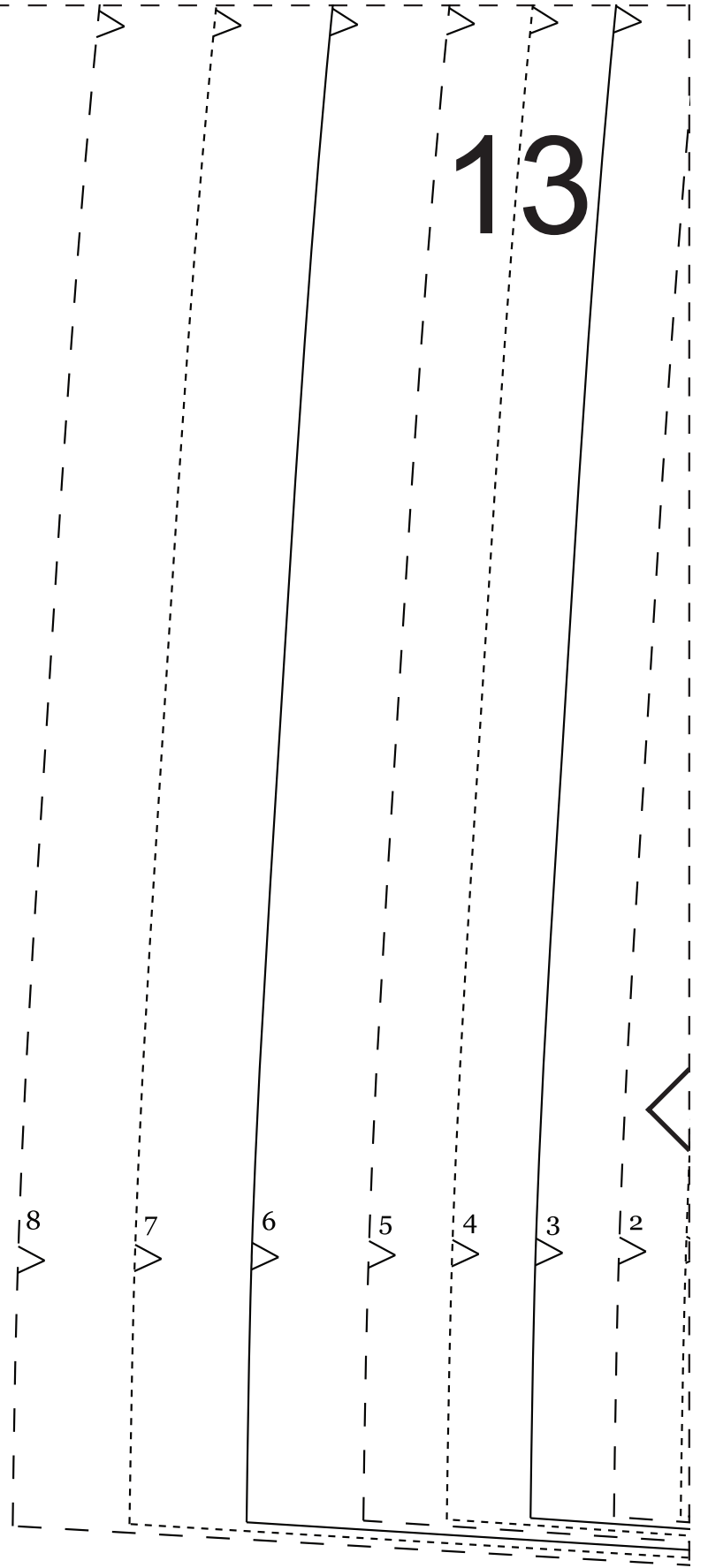
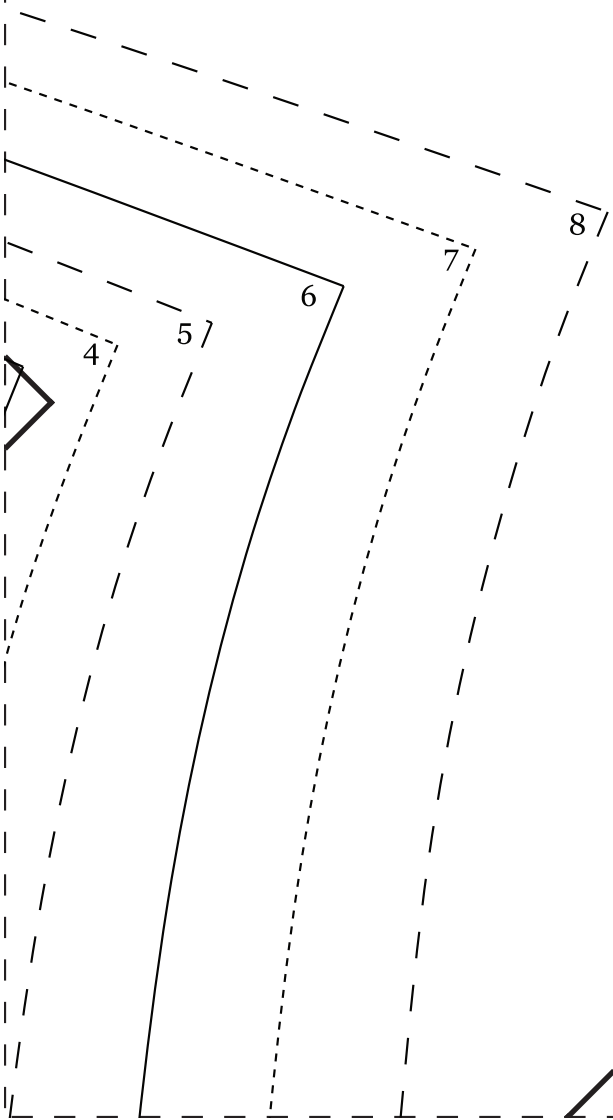
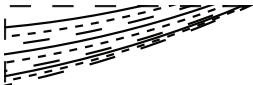

14

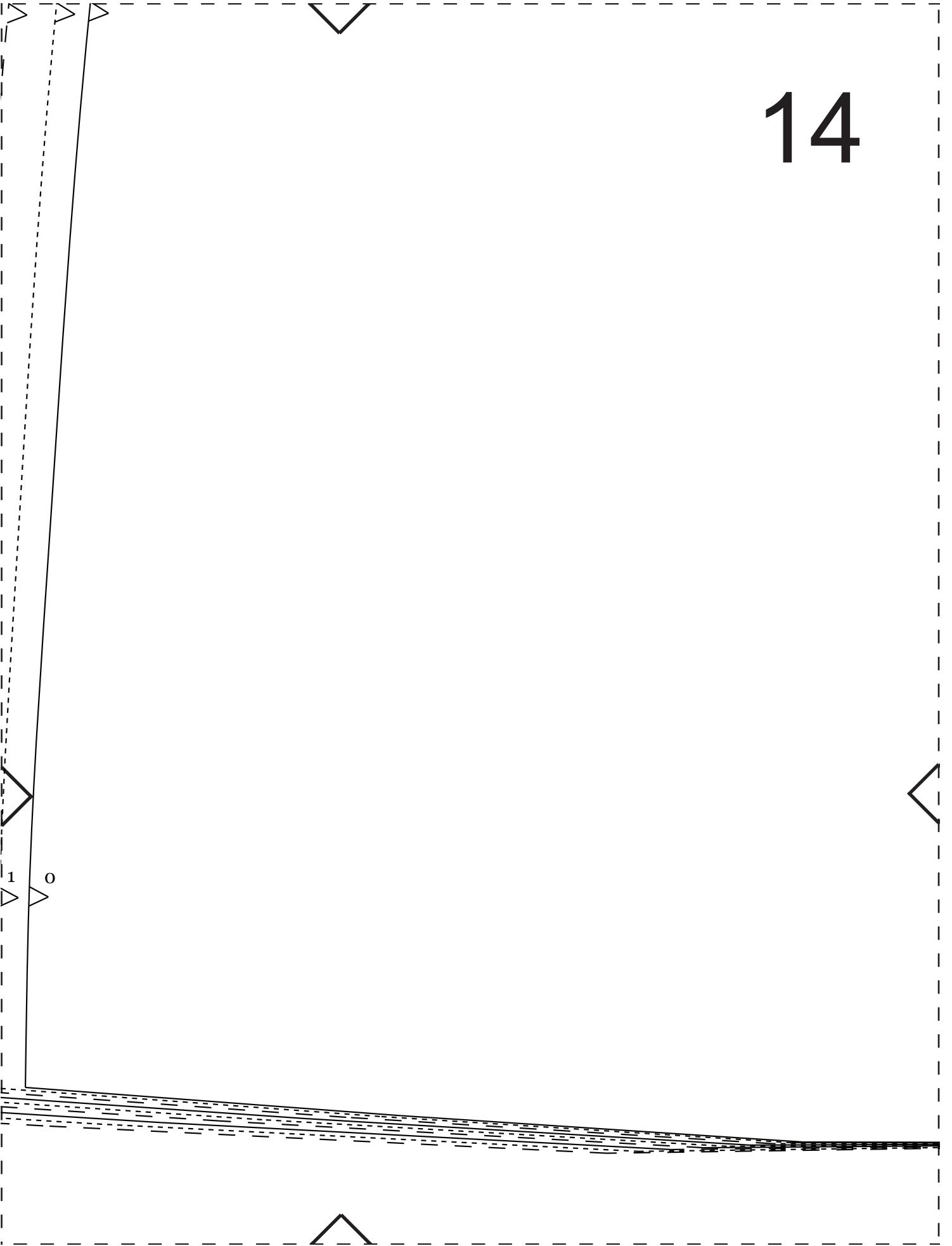

15

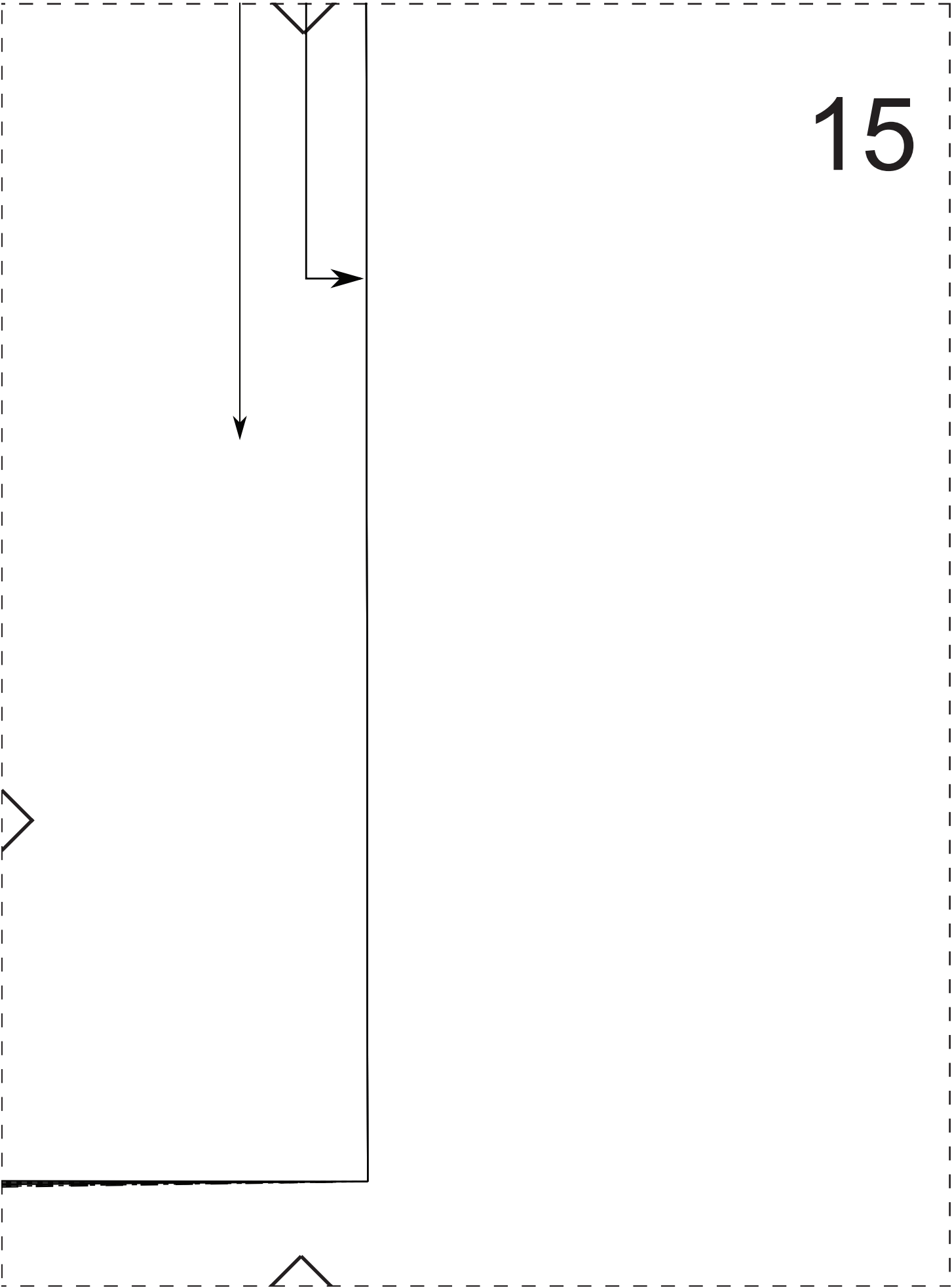

BACK CUT

CUT 2

seam allowances included

16

STITCH TO HERE



straight grain



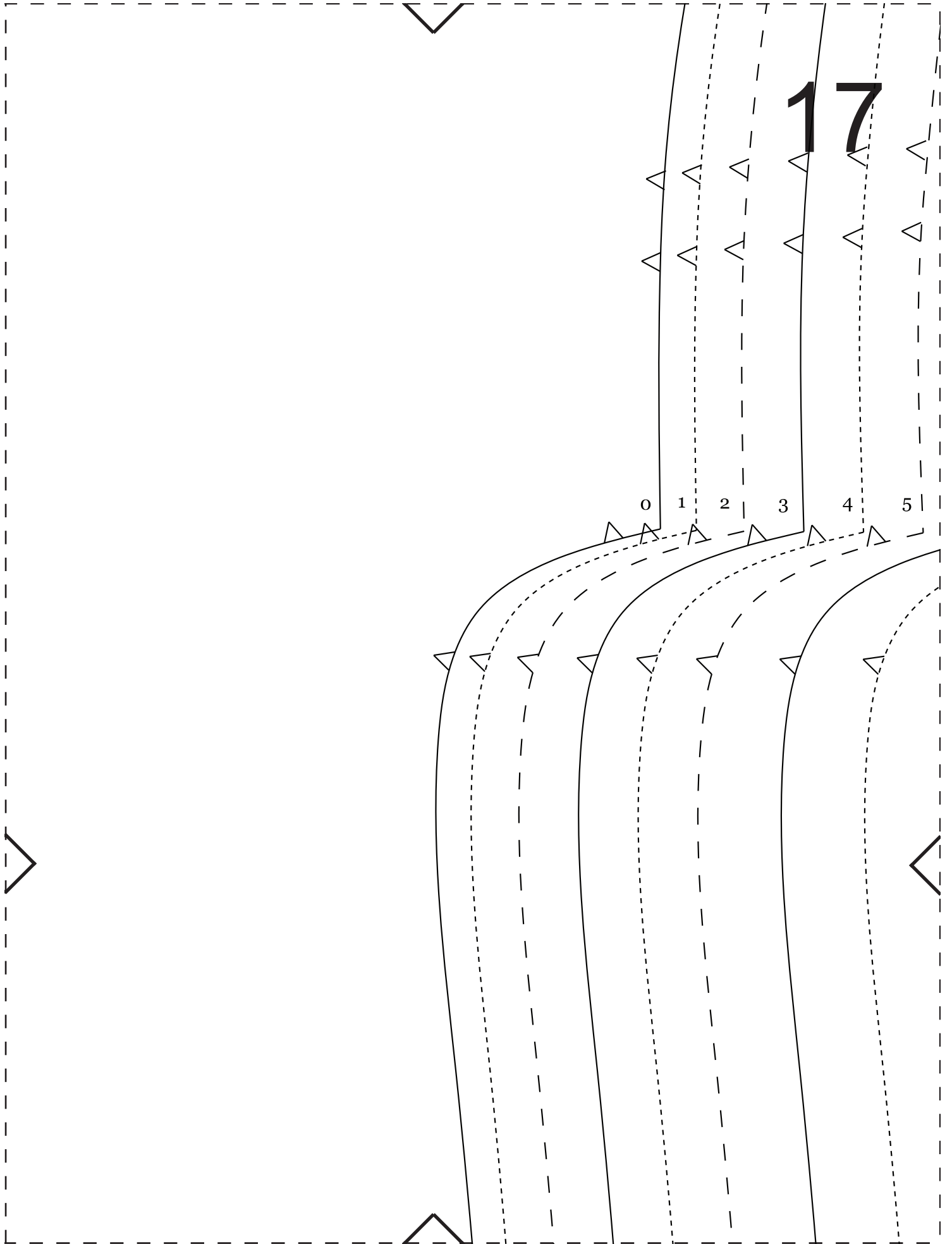

17

0

1

2

3

4

5

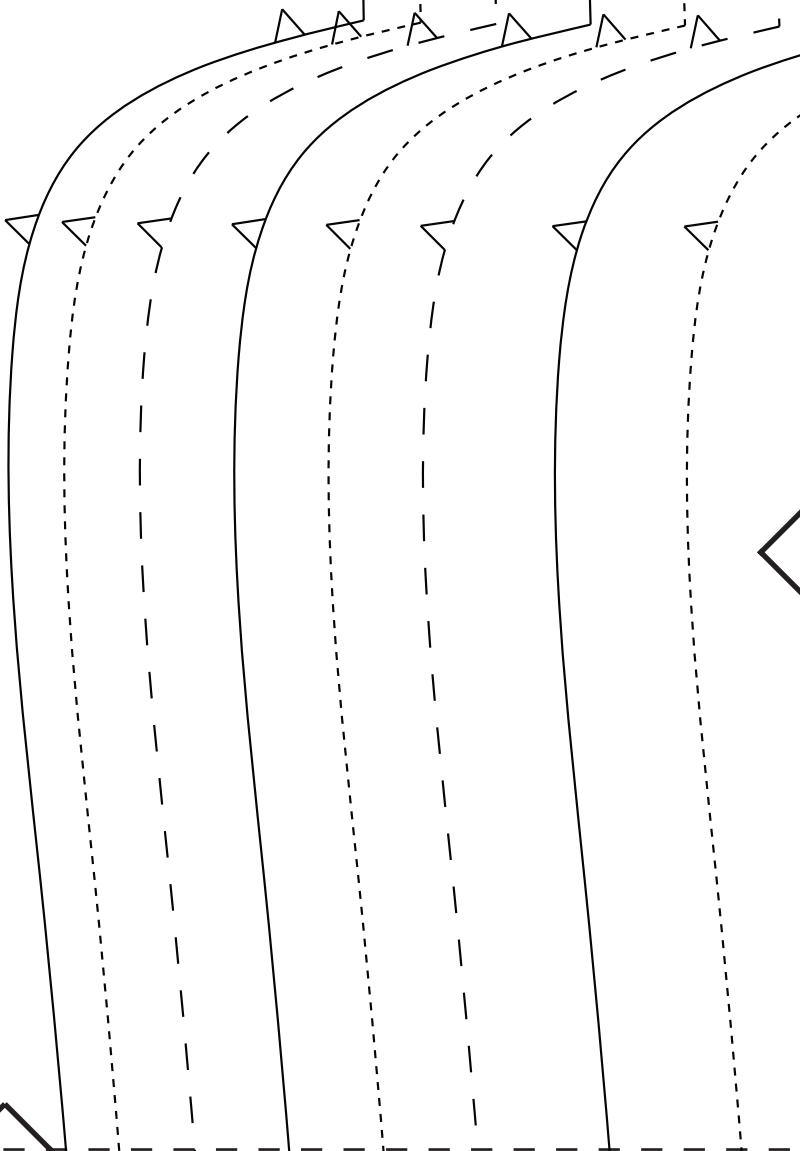
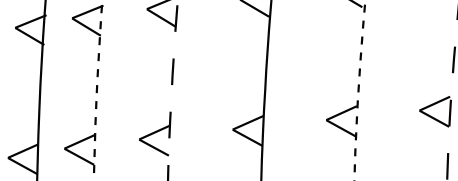

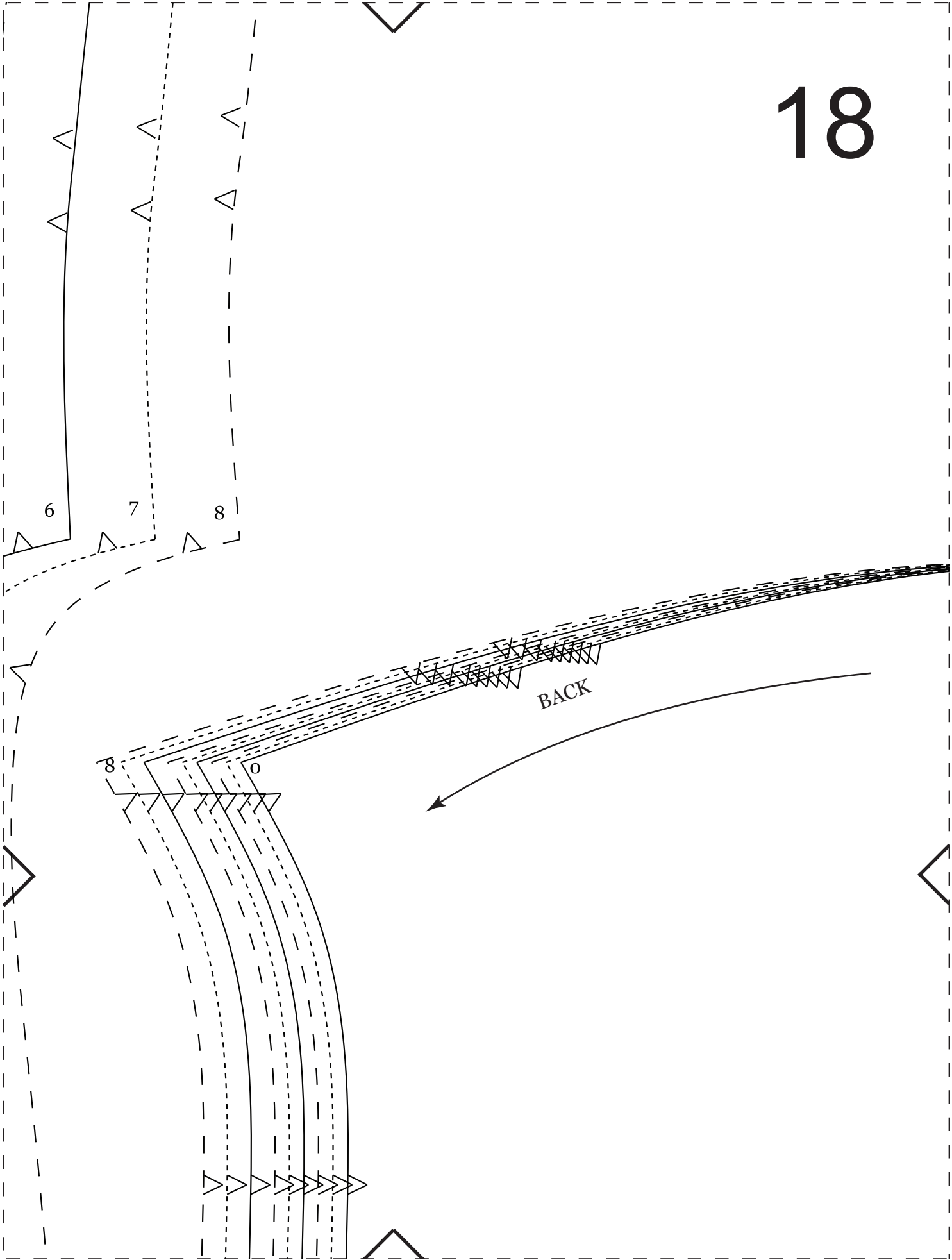

19

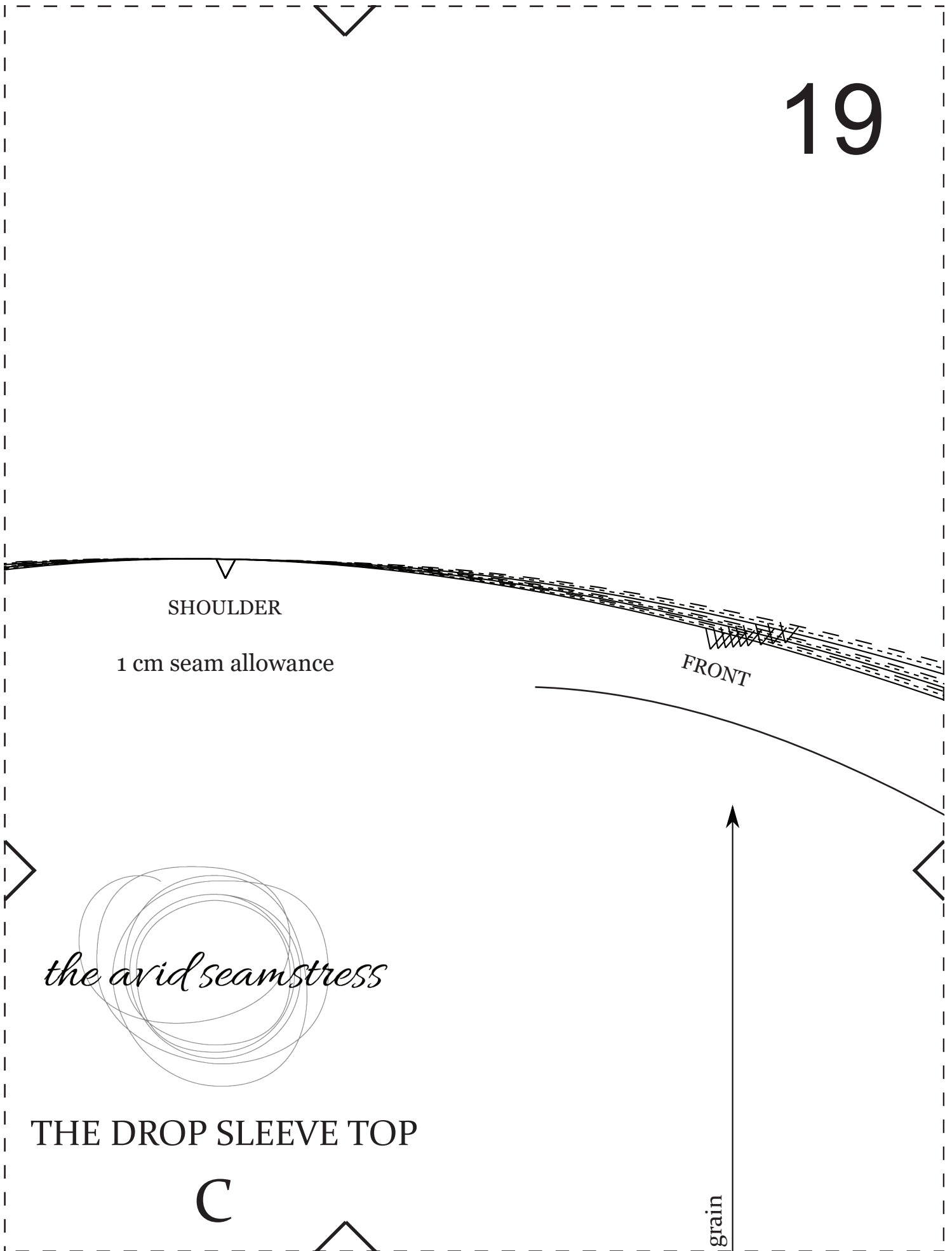

SHOULDER

1 cm seam allowance

FRONT

the avid seamstress

THE DROP SLEEVE TOP

C

grain

20

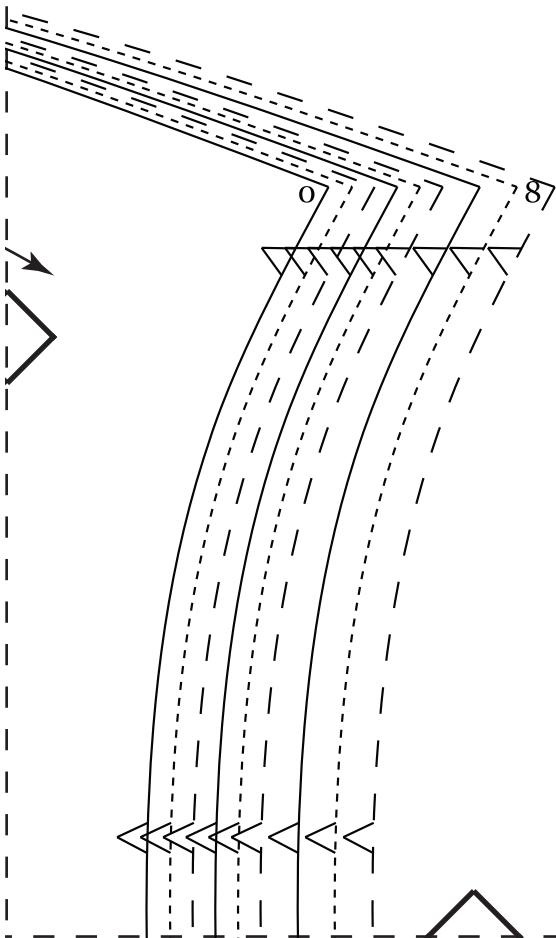

21

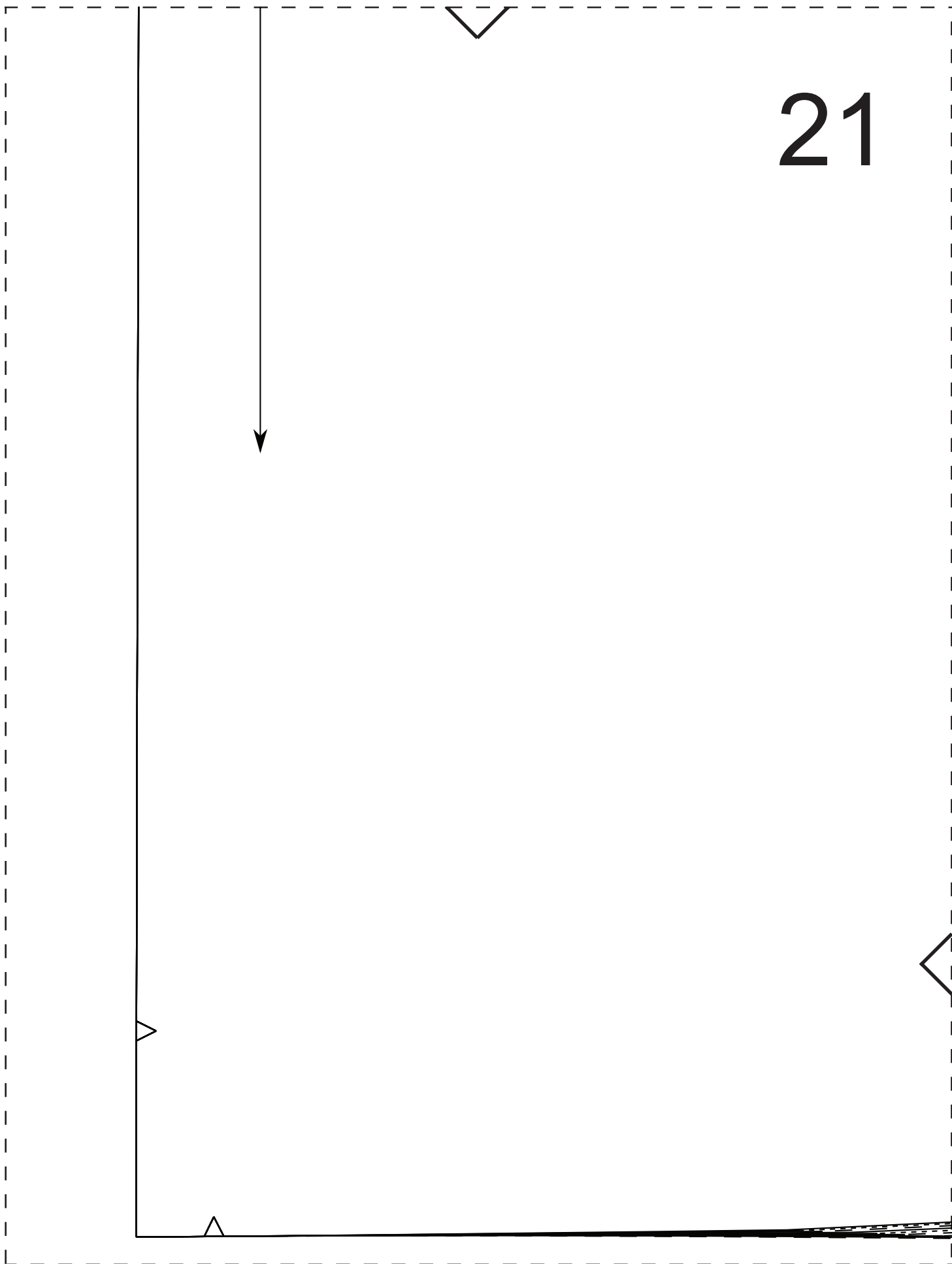

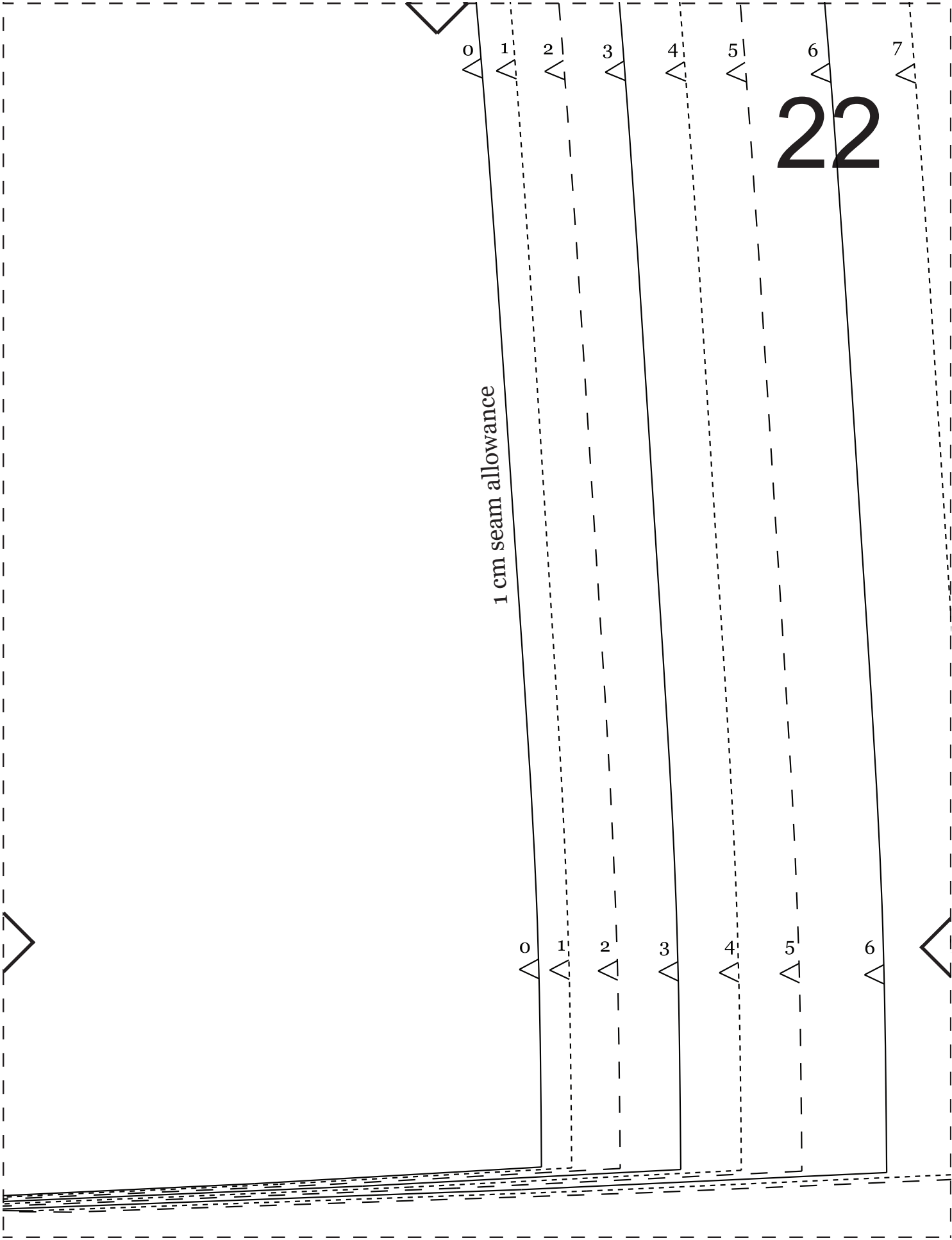

1 cm seam allowance

22

0 1 2 3 4 5 6 7

0 1 2 3 4 5 6

23

1 cm seam allowance

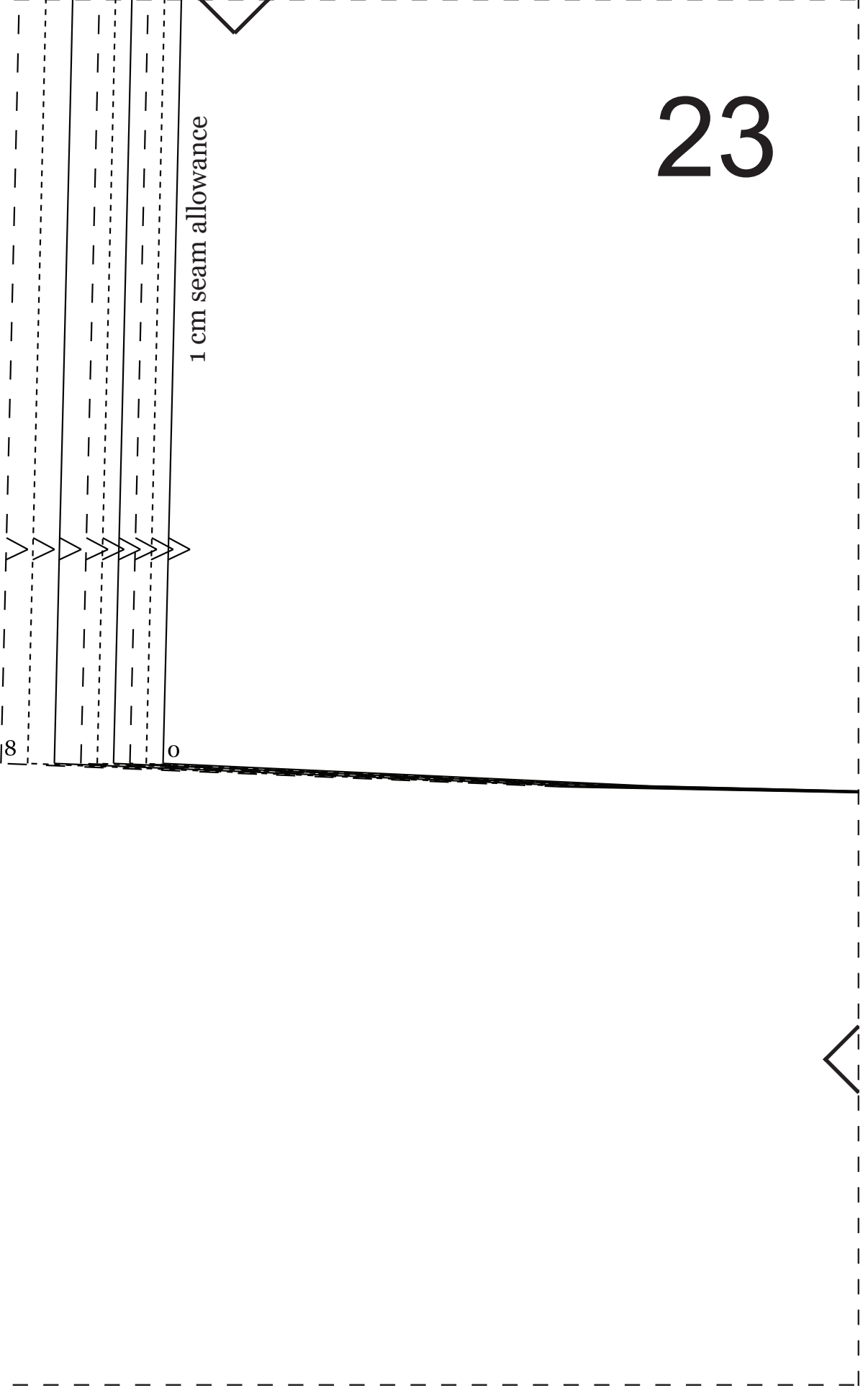

SLEEVE

CUT 2

seam allowances included

straight grain

24



25

1 cm seam allowance

