

LIGHTING
CATALOGUE
VOLUME 3.1

ankur[®]
2022-2023

"Seeing is truly believing since 1979".....

About us

Shri R.K Shah
(1949-1990)

Founded in 1979 by (Lt). Shri R.K. Shah with the philosophy of manufacturing lighting fixtures which would be attractive and simple to install. From the modest beginnings of a one-showroom, one-factory facility, ANKUR LIGHTING, has now grown to become one of the largest manufacturers, retailers, wholesalers and distributors in the world of lighting.

Today we command leadership amongst specialty LED indoor, outdoor, technical, architectural and customized lighting. We have a process of continual upgrading our products through rigorous R&D that done in-house, running on our toes to providing better lighting solutions for every need.

ANKUR LIGHTING has a total commitment to a "Customer First" attitude and to being consistently superior to competitors in fulfilling customer needs. ANKUR LIGHTING's mission is to become the only lighting "One stop lighting solution provider" haven where **"Seeing is truly believing"**.



WELCOME TO OUR WORLD....



We make light that makes you see, light that makes you look, light that animates the world around you.

We develop lighting solutions that enhance people's life, and therefore peoples's quality of life. We bring our experience in light to the service of architects, interior and lighting designers, realizing what is in their mind, creating a lighting scenography integrated in the architecture. Using the right light in the right way to make architectural concepts stand out.



Endeavor for exquisite, calm & safe lighting

Mission to evolve advance & soothing lighting

Vision to lead "make in india LED products" into global acceptance

Known for innovation & transforming illumination dreams into reality

Beliefs & Values integrity, perseverance, passion to create best relation & sustainability

Today, Ankur lighting, having the manufacturing base at Sahibabad industrial area, Ghaziabad, command leadership amongst the LED luminaries like tracks, vintage Chandeliers collection, panels, down lighters, street lights, flood lights, high bays, bollards, floor lights, hanging lights, spikes, strips, wall lights, facade lights, spot lights, underwater, burial lights and customized smart lighting automation through programmable dimming and colour temperature.

We have a continuous product upgradation through stringent In-house R&D facility, adapting to the latest technological advancements and better understanding of the customer's lighting needs.

WE ARE ANKUR LIGHTING

An essential tribute in Ankur lighting's creative process is the extensive in-house design, development, testing, engineering and manufacturing of all products.

This enables the company to realize its short idea-to-market philosophy, resulting in extensive new collection on a very regular basis.



The lighting industry is constantly changing and evolving. We consider this both to be a challenge and an opportunity. It fascinates us to keep on bringing **new designs and lighting solutions**. You could consider it a passion to surprise and inspire people around the world. We start from our own **in-house design team**, but also love to explore common grounds with Architects and Designers, coming from different industries, exceeding the essence of collaboration.



Ankur Lighting's extensive **R&D team** is constantly on the look-out for the trends of the future, both in terms of design and use of material, without losing sight for the power of imagination. Its creative statement is confirmed by the opinion of several expert panels.



An important feature in Ankur Lighting's creative process is the use of the state of the art development techniques.

The intensive use of 3D printing , early stage FMEG(Failure Mode and Effect analysis), gonophotometry and in - house third party recognized lab result in a fast, efficient and first time right development process. As such, an essential attribute in the company's short idea-to-market philosophy.

Throughout the entire production process Ankur Lighting itself by handling the strictest quality parameters, to ensure products and services are designed and produced to exceed customer requirements. Every step in the production process has a routine quality procedure, covering both product quality and testing. Each product that leaves from factory , has been inspected and tested thoroughly, resulting in minimal returns and maximum efficiency.





DESIGN

We are focused on the details, the looks, how a fixture moves, how it can be specified and installed, the ease of enjoying the light and so much more. With a surprising visual simplicity, our products are the result of extensive **research and testing**, fusing **advanced technology** with timeless design and sustainable materials.

The breakthrough of LED technology currently being experienced is probably the biggest development in lighting technology for decades. Ankur lighting plays a leading role in implementing this new technology, designing and manufacturing its own LED lamps; developing **innovative LED products** and tailor-made solutions, enabling designers and users alike to optimally exploit the previously unimagined possibilities in lighting.

Ankur lighting's team of LED engineers is on a continuous quest to match the company's credo for design with energy - efficiency and optimal quality of light. Through extensive in-house testing, advanced product development knowledge and continuous optimization of materials used, Ankur Lighting is able to provide architectural lighting which excels in optical performance, durability and efficiency.





TECHNOLOGY

The collection enables designers to create different lighting scenes, from accentuation to ambient, wall washing, orientation or open area lighting, selecting from an extensive range of beams, filters, lenses and other accessories.





ankur
LIGHTING
An ISO 9001:2008 Certified Company

We create a more vivid world
New generation LED provides distinctive bright colors



PHILIPS



CREE



CITIZEN



PHILIPS Driver



TRIDONIC Driver



EAGLERISE Driver



BOJO Driver

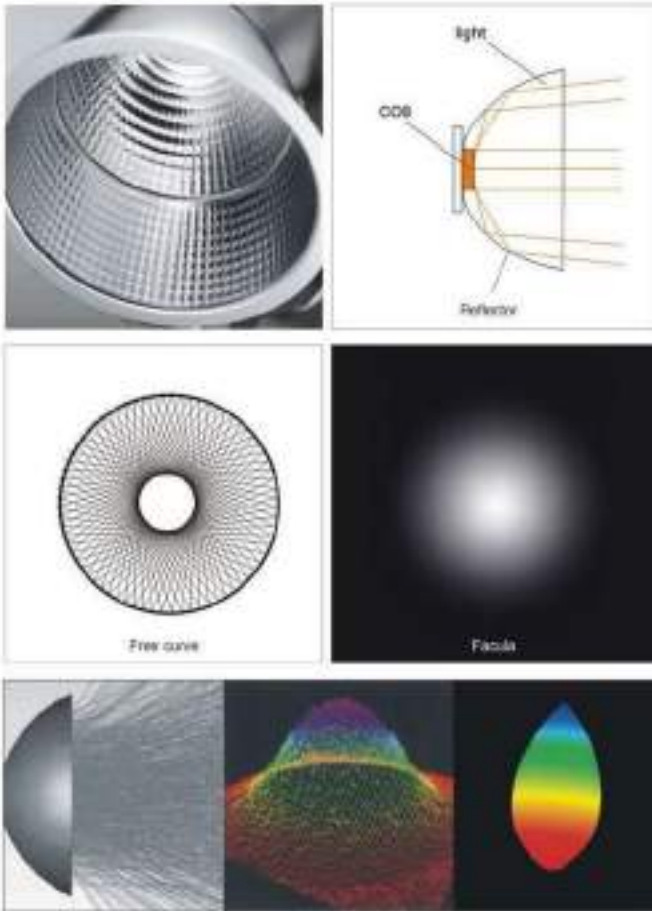

Select different reflectors according to the requirements of different lighting scenes. The following are renderings of different lighting angles.

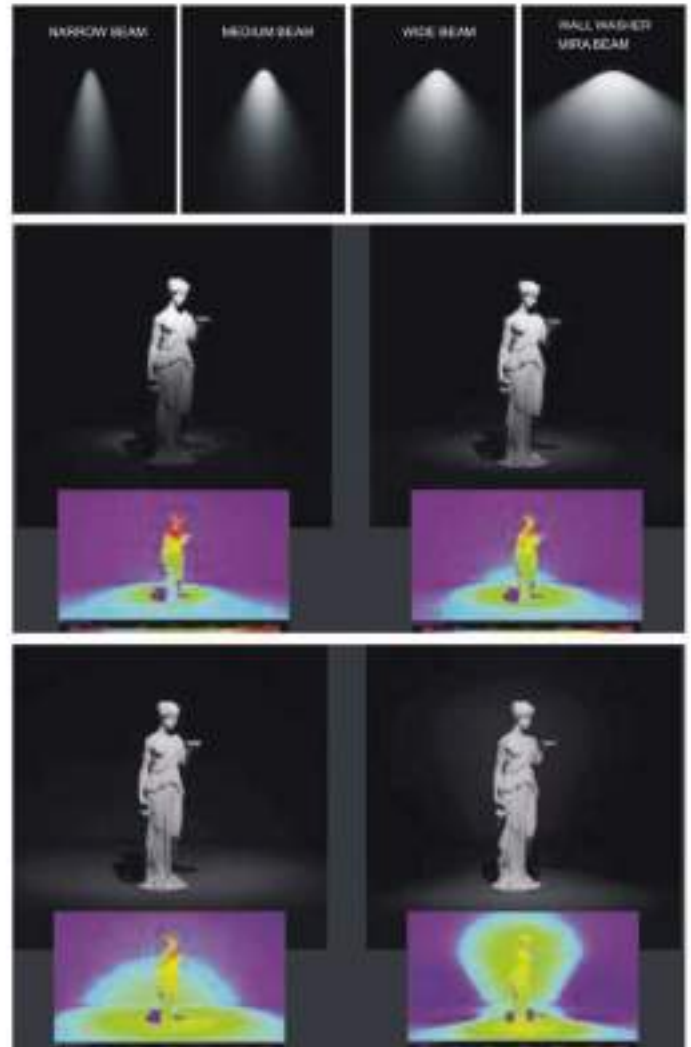

Reflector

Advanced optical design. Application of high precision production equipment and high purity. An optical device made of an optical material that allows maximum exposure to light shoot out, effectively reduce the reflected light loss, improve the optical efficiency and quality.



Human being's normal sight range is straight forward above 30° to under 60° , within the scope of the dazzling light is called glare.
All the Ankur Lighting light of lamps was controlled within the sectional light Angle of $30^\circ >$, so glare problem has been cancelled.

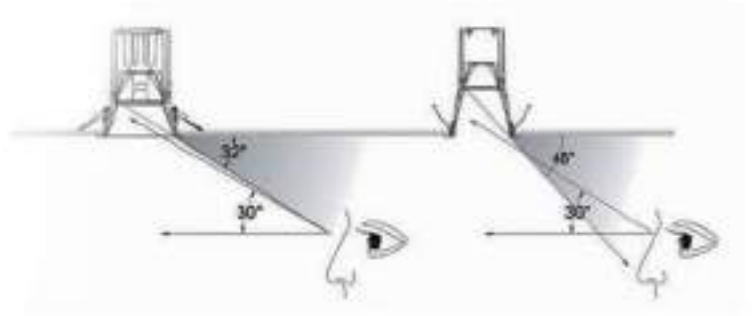

UGR < 19
FOR CHILDREN'S FUTURE



Lighting mode

Main lighting

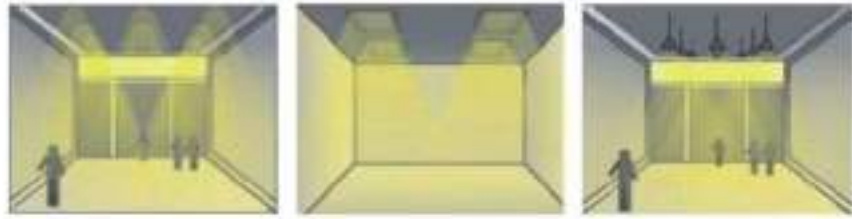

Auxiliary lighting



Focus lighting

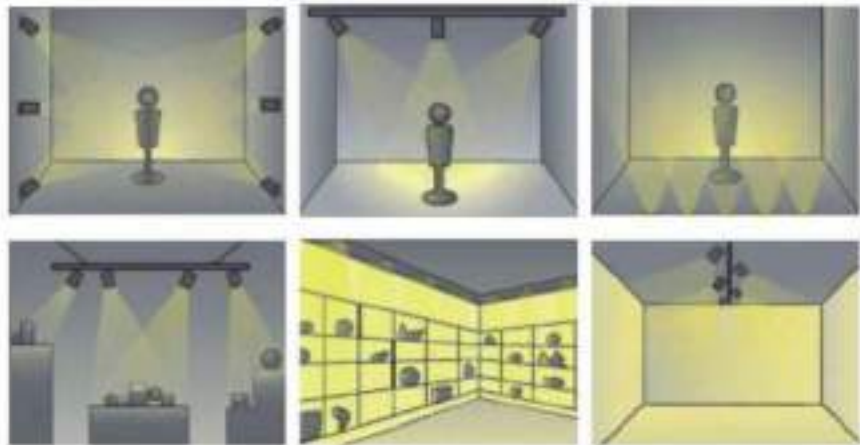

Washing lighting



Transmit lighting



Shorter lighting

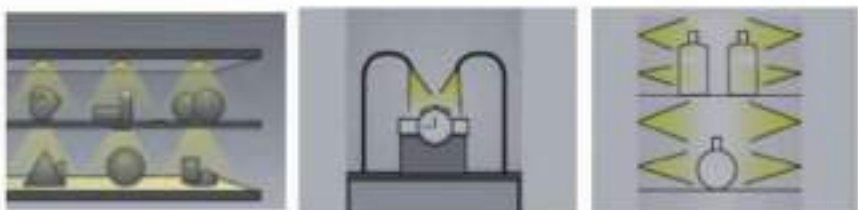

SALES NETWORK



Our Presence

Pan India Channel Network

PRESTIGIOUS CLIENTELE



YEARS OF LEGACY

APPLICATIONS

COMMERCIAL LIGHTING



MUSEUM LIGHTING



LANDSCAPE LIGHTING



AUTOMATIVE LIGHTING



AREA LIGHTING



STAGE LIGHTING



NICHE LIGHTS



7004 Round



7004 Square



9450 WH



9450 BL



203dp WH



203dp BK



9449 Wh



9449 Bk

These recessed mini LED downlights are a perfect fixture range that provides an efficient and elegant lighting solution. These are manufactured to enhance the aesthetics of your home and add a charming shimmer to your showroom, hotel, or restaurant. With promising durability and the right choice for your home, these downlights are built adhering to the safety and comfort of your eyes.

9449

Adjustable

Tilttable - 2 Sides



Small & Exquisite

A tiny but powerfull 2w/3w micro sized. Mini LED in an extremely compact fixture which is ideal for applications requiring discrete, atmosphere lighting

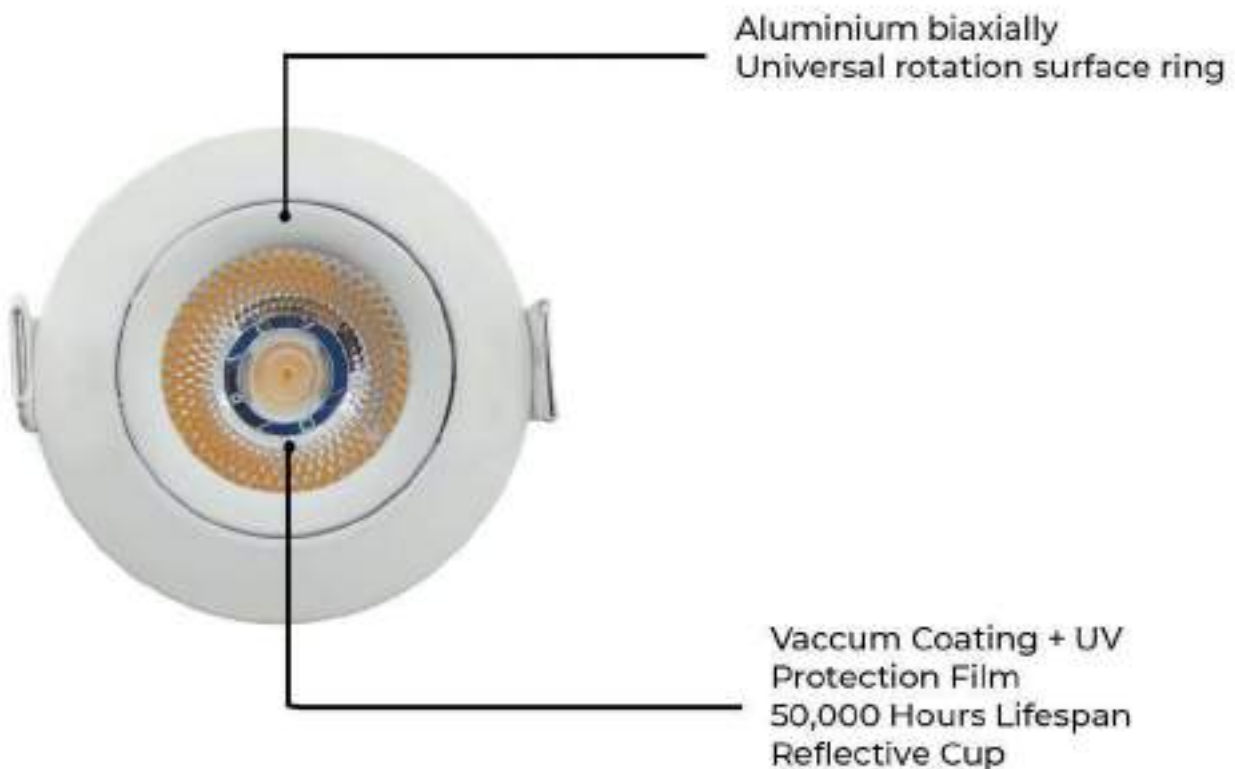





ANKUR XRL - LED - 9449 3W

Material: Aluminium
Rotates: 2 Sides Tilttable
Optics: Clear Glass
Lamp: COB
Wattage: 3W
Color Temperature: 3000K / 4000K / 6500K
AC20V - 50/60Hz
Size: D: Ø60mm x H: 23mm
Cutout: Ø50mm



Available Colour:



Compact Driver Along With Fixture

9450

Mini

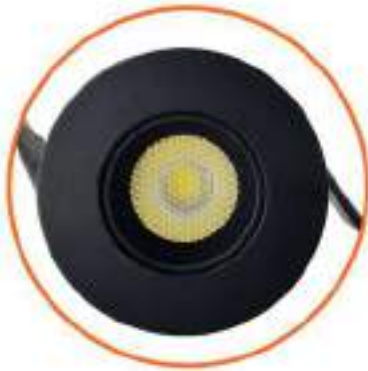

High Quality LED



Strong Metal Clamps



Small In Size



Better Heat Sink



Clear Glass Lens



Anti Glare Recessed Downlight

Ideal for any residential or commercial interior space

Features

- Aluminium Heat Sink
- Energy Saving
- High Brightness
- No fading, long life
- Protection rate : IP20





ANKUR XRL - LED - 9450 3W



Material: Aluminium
 Rotates: Fixed
 Optics: Clear Glass
 Lamp: COB
 Wattage: 3W
 Color Temperature: 3000K / 4000K / 6500K
 AC20V - 50/60Hz
 Size: D: Ø40mm x H: 27mm
 Cutout: Ø35mm



Available Colour:



Compact Driver Along With Fixture

7004

RD & SQ



This Mini LED Downlight is designed as low anti-glare performance, for commercial places like hotel, supermarkets, offices or cabinets etc. The volume is small





7004



26 millimeter
Scale 1:1





ANKUR XRL-LED-XL 7004R

Material: Aluminium
Rotates: Fixed
Optics: Clear Glass
Lamp: COB
Wattage: 3W
Color Temperature: 3000K / 4000K / 6500K
AC20V - 50/60Hz
Size: D: Ø32mm x H: 26mm
Cutout: Ø28mm



Available Colour:



WH



BK



SV



Compact Driver Along With Fixture



ANKUR XRL-LED-XL 7004S

Material: Aluminium
Rotates: Fixed
Optics: Clear Glass
Lamp: COB
Wattage: 3W
Color Temperature: 3000K / 4000K / 6500K
AC20V - 50/60Hz
Size: L: 30mm x W: 30mm x H: 26mm
Cutout: Ø27mm



Available Colour:



WH



BK



SV



Compact Driver Along With Fixture

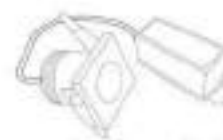

203DP

Adjustable

Tiltable - 2 Sides



Features

1. High efficiency optical lens with 1*3W LED, offering high lumen output
2. Anti-glare PMMA optical lens come out with uniformity and comfortable lighting
3. High CRI LED light source, environment-friendly lighting with no hazardous substance
4. Dimmable or non-dimmable is also available
5. Recessed installation only
6. IP20 suitable for indoor usage





ANKUR XRL - LED - 203DP

Material: Aluminium

Rotates: Tiltable

Optics: Clear Glass

Lamp: COB

Wattage: 3W

Color Temperature: 3000K / 4000K / 6500K

AC20V - 50/60Hz

Size: D: Ø60mm x H: 54mm

Cutout: Ø55mm

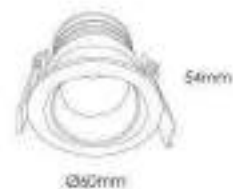

Available Colour:



Compact Driver Along With Fixture

Deep Recess

Downlight Family



Deep Recessed light source, reduced glare

Ankur's Round Deep Downlight Casings are the best way to complement your lighting solutions. It provides added resilience and durability and is the ultimate option for Ankur's premium lamps such as the GU10 LED Lamp and the ZR LED Module Lamp. This excellent downlight casing has been fashioned with high quality aluminium, which makes for easy maintenance as well.

THREE SIZES

WITH SIMILAR PROPERTIES



6332 Downlight

Aluminium Body

Aluminium body for better heat dissipation



Design of Deep Anti Glare

High quality COB chip, provides long life



Available Lamp Sizes

Module lamps are design to fit easily
in the casing

Available Lamp Wattage: 8W, 15W



First insert jacket part
then place lamp inside it



Easy to install or uninstall without
damaging the ceiling.





6333 Tiltable Downlight



Ankur's Round Deep Adjustable MR16 Downlight Casing greatly helps our lamps deliver on their promise of high quality and efficient lighting. The casing has been crafted with a view to expertly shield Ankur's GU10 LED Lamp and Ankur ZR LED Module Lamp from most wear and tear and thus promotes longevity. Being tiltable, it also provides a high degree of convenience.



Wattage: 8W

Wattage: 15W



Rotates and it
gets locked inside
Jacket



Easy to install or uninstall without
damaging the ceiling.

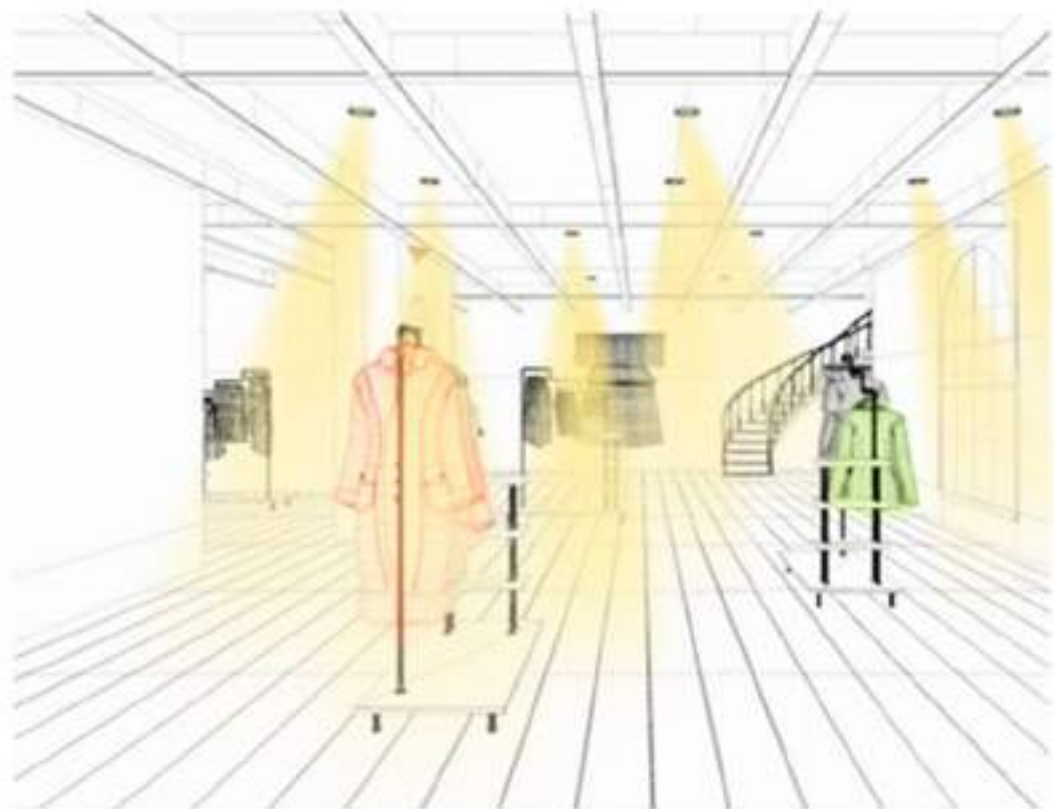



9312 Downlight



A minimalist's delight, this recessed downlight in a stunning black and white finish is great for urban homes. Adding a touch of luxury and muted tones to your home, this light works incredibly well with both low and high ceilings and in spaces that do not get natural light such as rooms in the centre of the house.

Whether it's your kitchen that needs to be better lit or a walkway where you want to be in the spotlight, this recessed downlight is versatile like your home.





INSTALLATION STEPS

STEP: 1

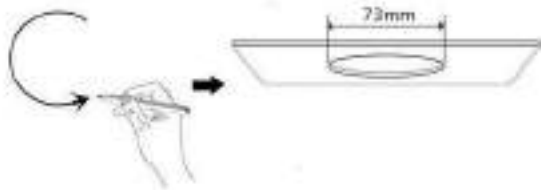

- Mark the location of light, and cut a hole of 73mm diameter

STEP: 2

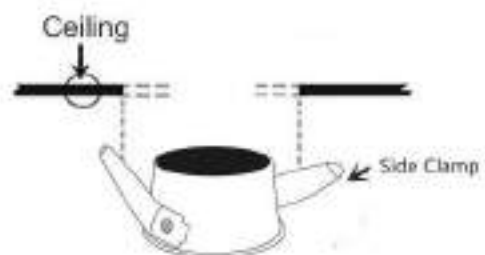

- First we need to insert the jacket part into the ceiling

STEP: 3

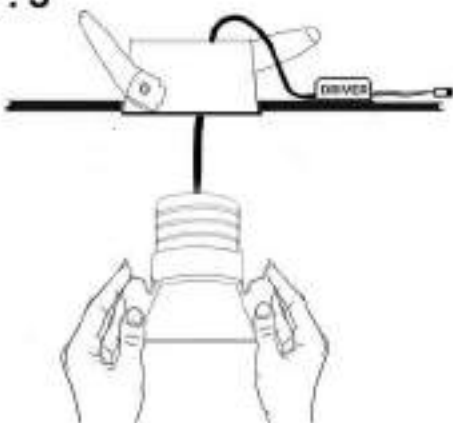

- Connect the wires to the driver
- Press the side clamps inward and place the light inside the jacket

STEP: 4

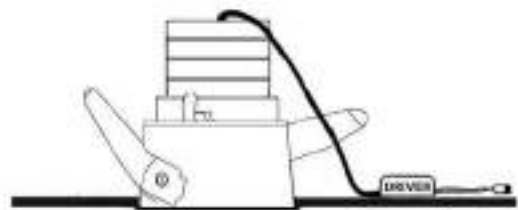

- Turn on the power switch
- Installation is completed, light is ready to use





ANKUR XRL - HG - IP/6333L

Wattage: As per lamp
CCT: 3000K / 4000K / 6500K
Material: aluminium
Rotates: Fixed
Spot head adjust: Fixed

Lamp: Module lamp

Size: Ø: 95mm H: 115mm
Cutout: Ø 85mm

Available color:



WH



BK



SV

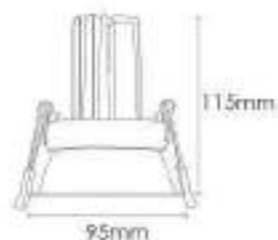

ANKUR XRL - HG - IP/6332L

Wattage: As per lamp
CCT: 3000K / 4000K / 6500K
Material: aluminium
Rotates: Fixed
Spot head adjust: Fixed

Lamp: Module lamp

Size: Ø: 77mm H: 115mm
Cutout: Ø 73mm

Available color:



WH



BK



SV

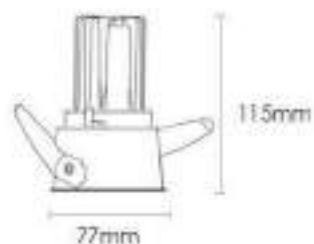

ANKUR XRL LED IP/9312

Wattage: 6W
CCT: 3000K / 4000K / 6500K
Material: aluminium
Rotates: Fixed
Spot headadjust: Fixed

Lamp: COB

Size: Ø: 62mm H: 72mm
Cutout: Ø 56mm

Available color:



WH



BK



SV

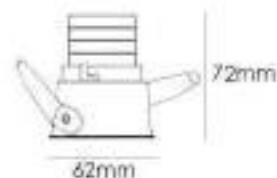



Lana

Series





A Glare free 12W/6W Tiltable LED Downlight (Spotlight). This range of LED light fixtures are a modern, flexible product range suitable for many applications. With a CRI >85 they render rich natural colours that enhance skin, surfaces and textiles to provide excellent visual clarity in every environment. Natural white light effect, perfect for many commercial environments including restaurants, retail and hotel. Easy to install with spring clips.





Available in 2 sizes

Created and designed for high-end retail, hospitality and commercial applications. These directional downlights deliver targeted, precisely controllable lighting in galleries, museums, offices, shopping centers, commercial showrooms, restaurants, hotels, exhibition halls, window displays.







ANKUR LANA - 84 XRL LED IP/ 9493 12W

Wattage: 12W
CCT: 3000K / 4000K / 6500K
Material: aluminium
Rotates: Fixed
Spot headadjust: 30°

Lamp: 1x COB
Reflector angle: 14°/24°/36°/60°
Size: Ø: 84mm H: 60mm
Cutout: Ø 73mm

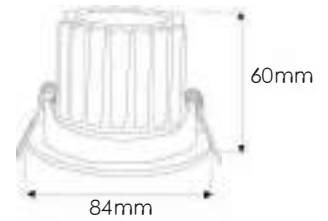

Available color:



ANKUR LANA - 74 XRL LED IP/ 9492 6W

Wattage: 6W
CCT: 3000K / 4000K / 6500K
Material: aluminium
Rotates: Fixed
Spot headadjust: 30°

Lamp: 1x COB
Reflector angle: 14°/24°/36°/60°
Size: Ø: 74mm H: 50mm
Cutout: Ø 65mm

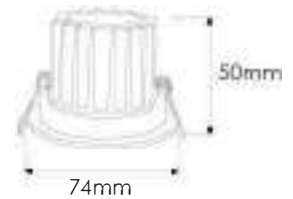

Available color:



Felix series



A minimalist's delight, this recessed downlight in a stunning black and white finish is great for urban homes. Adding a touch of luxury and muted tones to your home, this light works incredibly well with both low and high ceilings and in spaces that do not get natural light such as rooms in the centre of the house.



Smart design for easy installation

BAFFLED ANTI GLARE - COB LED DOWNLIGHT

Making the light more gentle and natural

Baffle downlights trap and shape light to minimize glare and reduce ceiling brightness, soften light output and help soften light glare. Baffle downlights are great for lower ceilings to create a softer, more comforting light.



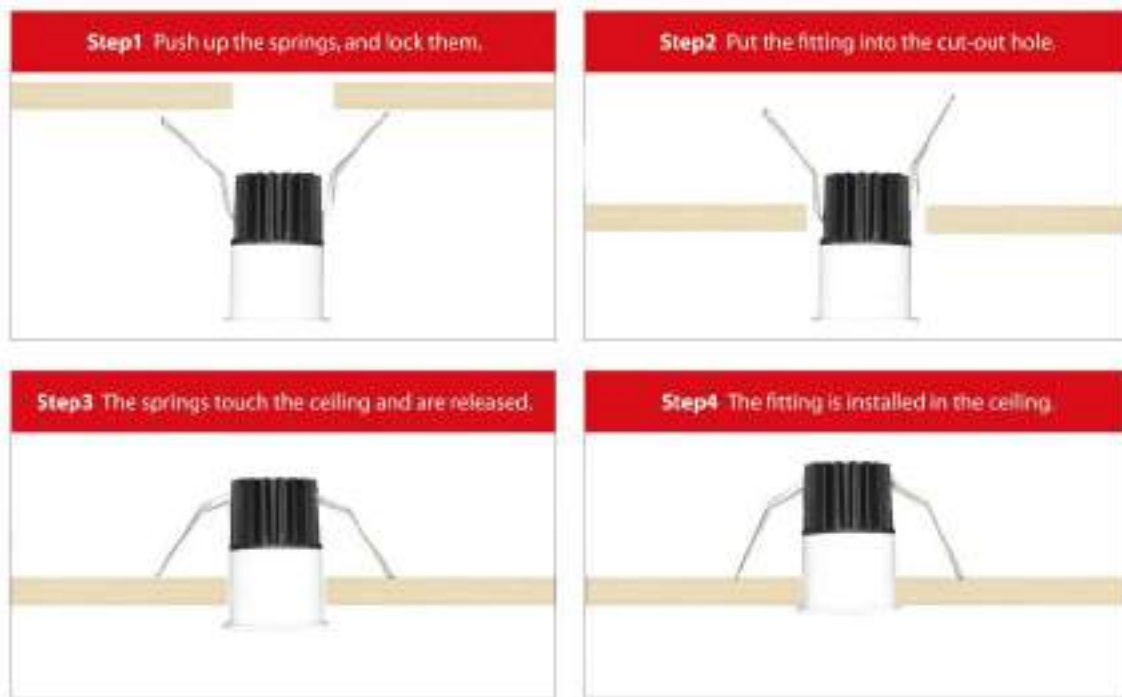

INSTALLATION STEPS

Available in two sizes





Whether it's your kitchen that needs to be better lit or a walkway where you want to be in the spotlight, this recessed downlight is versatile like your home





DEEP RECESSED COB

1. The product contains an aluminum die-cast front and a pure aluminum heat sink, completes with powder coating.
2. By using the new generation of CREE COB LED chip, this product creates extreme low heat and offers an excellent lumen performance.
3. A range of PC lens are available with different beam angles.
4. Clip installation and adjustable.
5. Professional design of smaller degree with lens and anti-glare.
6. Driven by constant current isolated power supply, no stroboscopic light, effectively protecting eyesight.
7. By using the ultra narrow edge design with small size, it can be better to dissolve in to building space and achieve a perfect combination



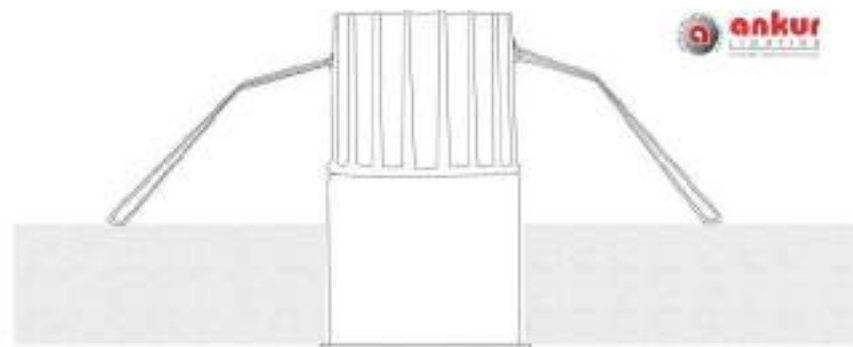
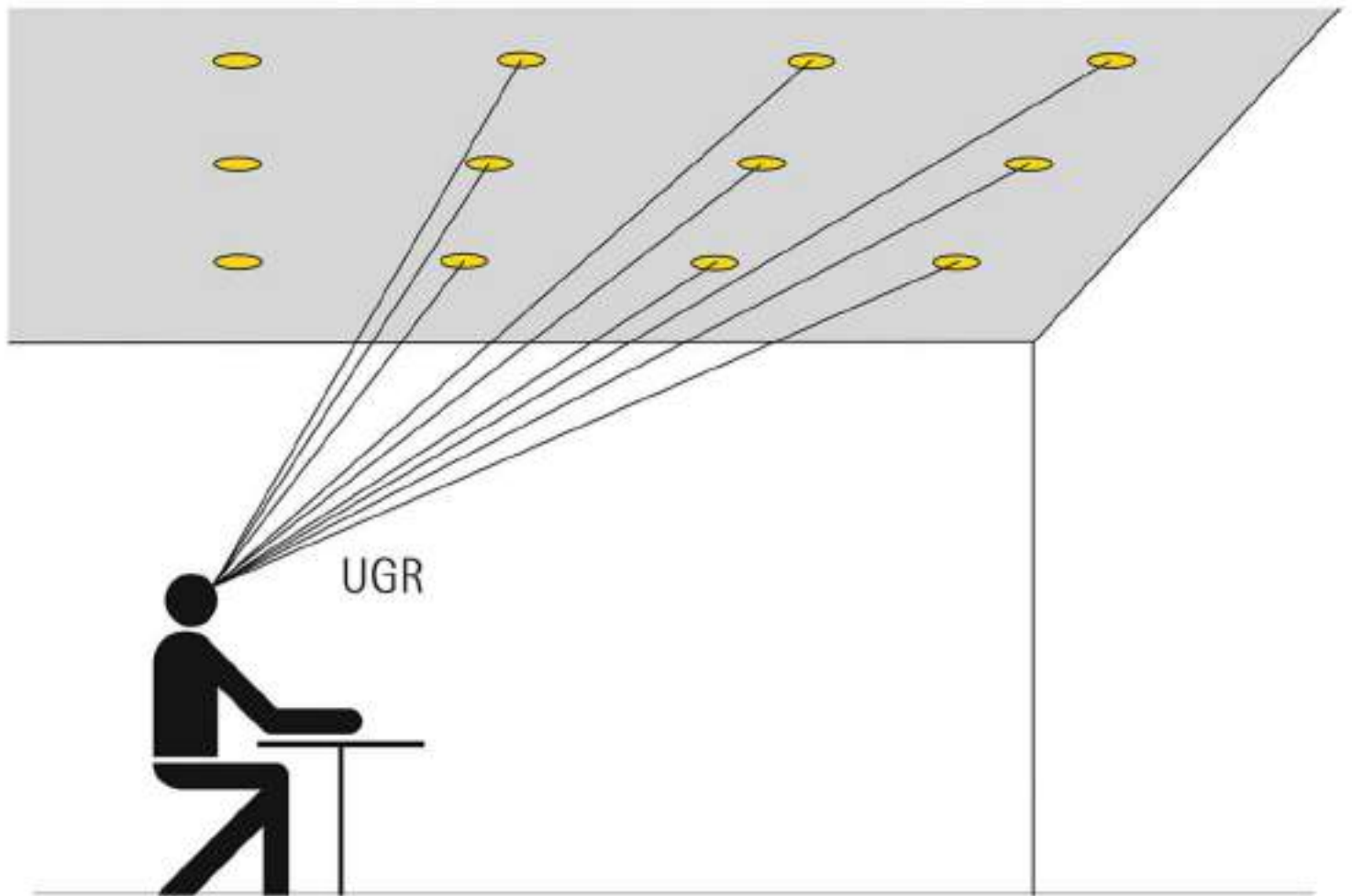

BEAM ANGLES DISTRIBUTION

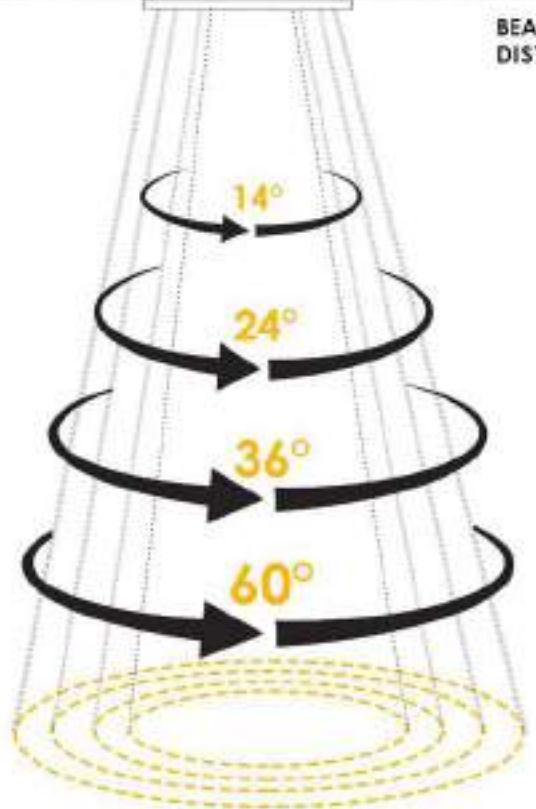

UGR 13	Excellent Glare Control
UGR 16	Good Glare Control
UGR 19	Moderate Glare Control
UGR 21	Poor Glare Control



ANKUR FELIX - 70 XRL LED IP/ 9497 12W

Wattage: 12W
CCT: 3000K / 4000K / 6500K
Material: aluminium
Rotates: Fixed
Spot headadjust: Fixed

Lamp: 1x COB
Reflector angle: 14°/24°/36°/60°
Size: Ø: 70mm H: 95mm
Cutout: Ø: 60mm



Available color:



ANKUR FELIX - 58 XRL LED IP/ 9498 6W

Wattage: 6W
CCT: 3000K / 4000K / 6500K
Material: aluminium
Rotates: Fixed
Spot headadjust: Fixed

Lamp: 1x COB
Reflector angle: 14°/24°/36°/60°
Size: Ø: 58mm H: 78mm
Cutout: Ø: 50mm



Available color:



ATL LISCA

Surface Mounted



LED surface mounted sturdy ergonomically designed downlight equipped with die-cast aluminium housing having smooth powder coated finish and anti-glare UV stabilized polycarbonate diffuser allowing 95% of uniform lux spread over. In-built heat sink for better thermal management with the energy efficient electronic driver having 3 KVA surge protection.

Small & Compact Design





Surface Mounted with
Clear Lens COB

Surface Mounted with
Polycarbonate
Diffuser



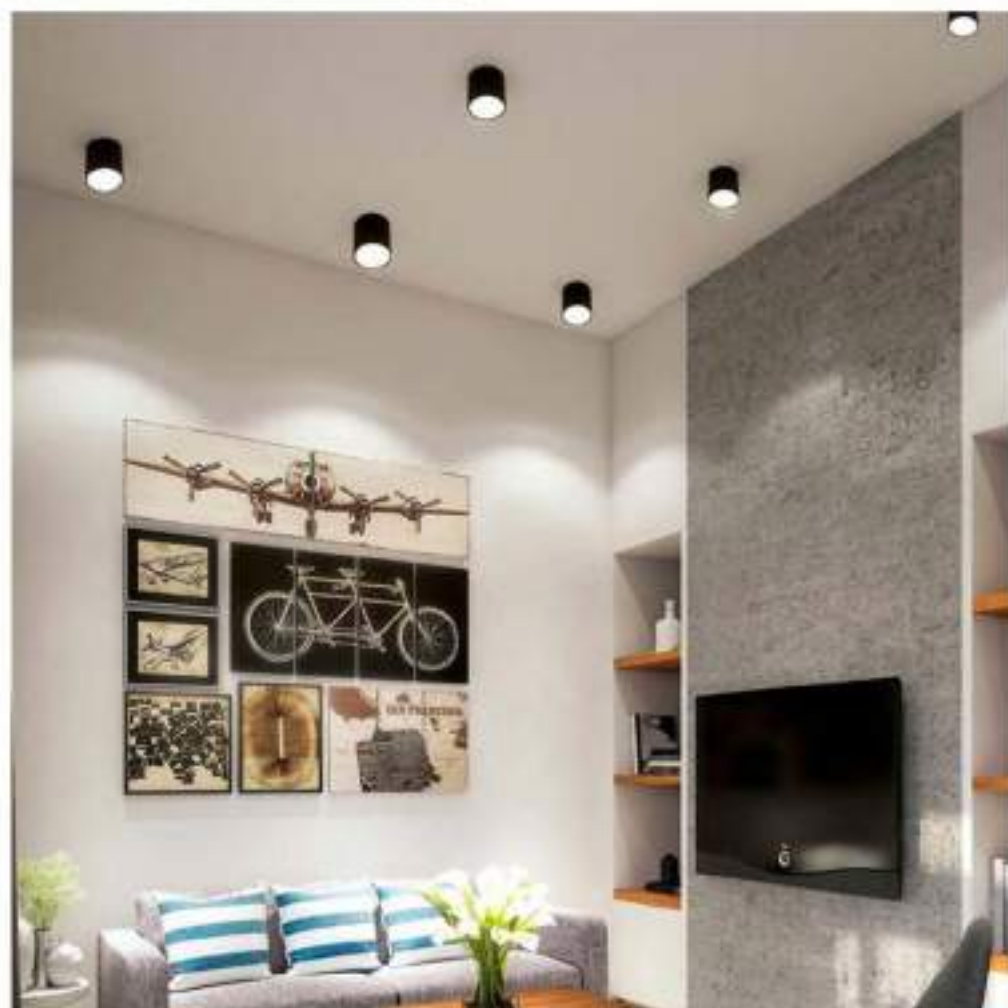



ANKUR XSL - LED - IP/9436

Wattage: 18W
Material: Aluminium
Optics: Engineered Clear Lens
CRI: 80/90
Colour Temperature: 2700K/3000K/ 4000K/ 6500K/ Tunable
Lumens Per Watt: 95lm/105lm/110lm/115lm
Reflector angle: 10°/ 20°/ 30°
Diameter : 85mm
Height : 95mm



Available Colours:



ANKUR XSL - LED - IP/9437

Wattage: 18W
Material: Aluminium
Optics: Polycarbonate Diffuser
CRI: 80/90
Colour Temperature: 2700K/3000K/ 4000K/ 6500K/ Tunable
Lumens Per Watt: 95lm/105lm/110lm/115lm
Reflector angle: 120°
Diameter : 85mm
Height : 95mm



Available Colours:

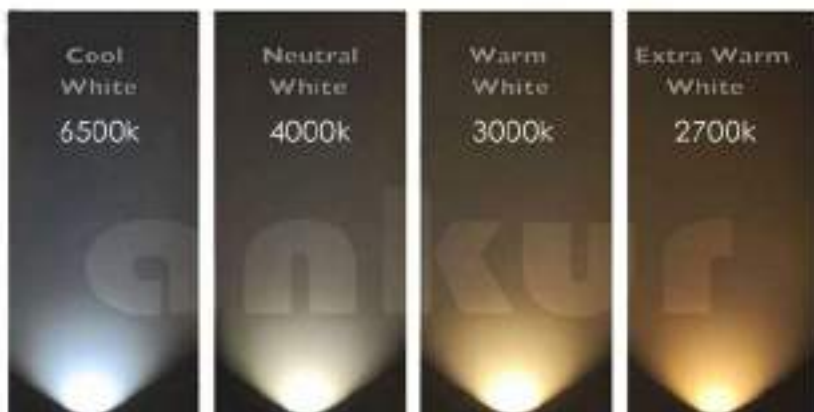

ANKUR ATL LISCA 9010 WITH COB



Deep recessed light source,
Reduced glare.



ATL LISCA DOWNLIGHT

LED recess mounted aesthetically designed downlights equipped with die-cast aluminium housing having smooth powder coated finish and anti-glare UV stabilized clear lens allowing 95% of uniform lux spread over. In-built heat sink for better thermal management with the energy efficient electronic driver having 3 KVA surge protection.



Glare Free



LISCA

The essence of brilliant lighting



ankur
LIGHTING
An ISO 9001:2008 Certified Company

LISCA's unique lighting technology, designed in ANKUR LIGHTING, is a high light in the world of miniaturized recessed luminaires. These modern downlighters are perfect for domestic or commercial use.

Uniformly distributed light from a high quality diffuser and a LED light source. Installing this downlight fixture can be relatively easy and quick.

It is also able to be used with either a dimmable and non - dimmable remote driver.



55mm





ANKUR XRL - LED - IP/9010 9W/12W/15W



ATL LISCA WITH POLYCARBONATE DIFFUSER

LED downlight has been specifically designed by incorporating cost saving materials to produce a cost effective and well performing downlight solution to the market. Suitable for use in offices, reception areas, restaurants, hotels, hospitals, Downlight equipped with die-cast aluminium housing with polycarbonate diffuser.



ANKUR XRL LED LISCA

Product Features:

- Instant start / Flicker free
- Energy-saving, Environmental protection and long life up to 50000 hours.
- High CRI(Ra), the Ra is >85, excellent colour rendering.
- Excellent colour consistency. - Mercury free and no UV/IR light, reduced CO2 emission.
- Ideal for office, retail, jewellers, home lighting etc.
- Available in different wattages - 9W / 12W / 15W





ANKUR XRL - LED - IP/9010 COB DEEP RD

Wattage: 12W / 15W
Material: Aluminium
Optics: Clear Lens
CRI: 80/90
Colour Temperature: 2700K/3000K/ 4000K/ 6500K/ Tunable
Lumens per watt: 95lm/105lm/110lm/115lm
Reflector angle: 10° / 20°/ 30°
Outer Dia: 115mm
Cut Out Dia: 103mm
Height : 100mm



Available Colours:



ANKUR XRL-LED-IP/9010

Wattage: 9W / 12W / 15W
Material: Aluminium
Optics: Polycarbonate Diffuser
CRI: 80/90
Colour Temperature: 2700k/3000K/ 4000K/ 6500K/ Tunable
Lumens Per Watt: 95lm/105lm/110lm/115lm
Reflector angle: 120°
Outer Dia: 115mm
Cut Out Dia: 105mm
Height : 55mm



Available Colours:

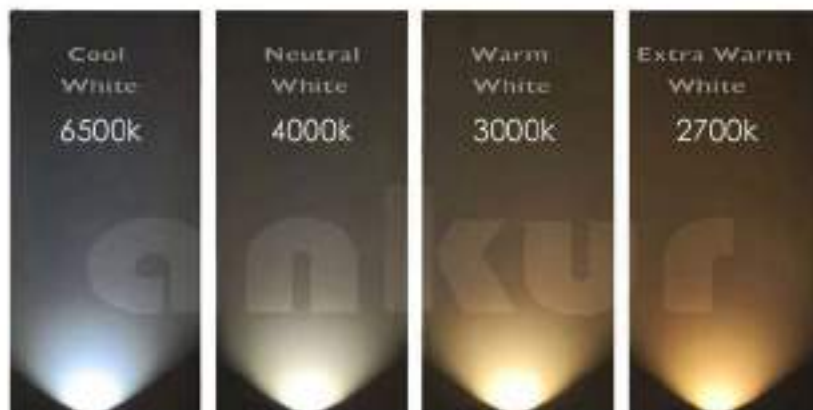

CUBIC

ROUND SURFACE
MOUNTED

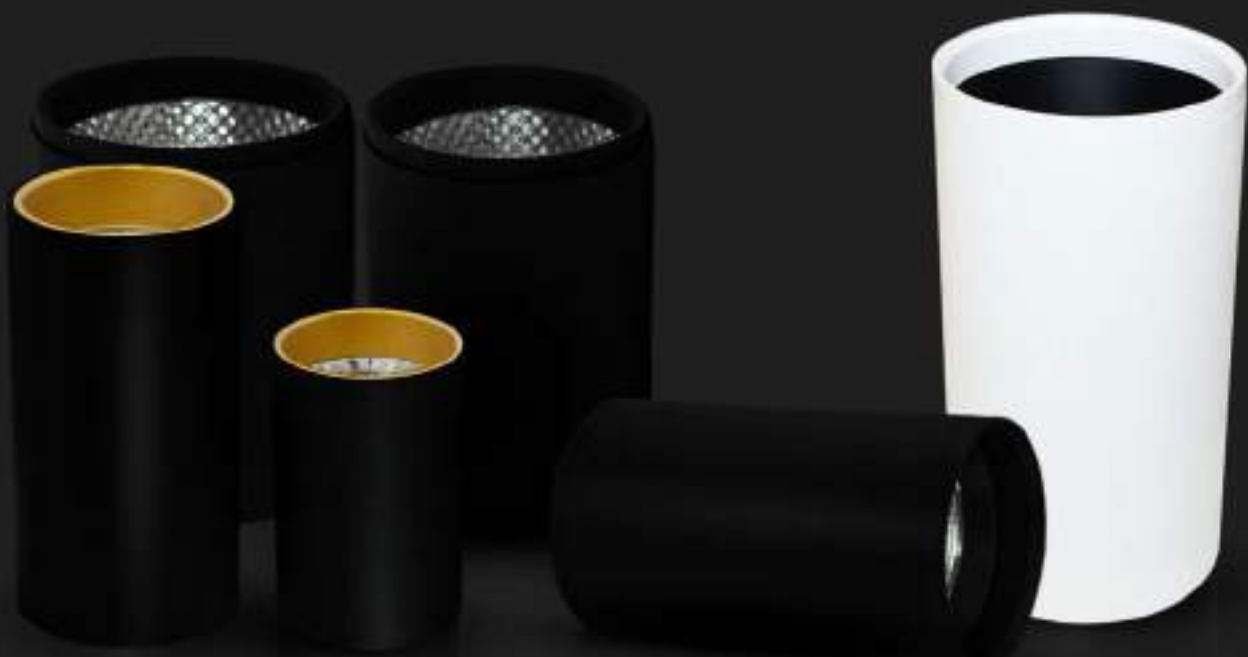

Aesthetically designed Surface mounted Round Cubic lights with die-cast aluminium housing having effective heat sink for better thermal. Equipped with Anti-glare UV Stabilized poly carbonate diffuser in powder coated finish with energy efficient electronic driver with 2.5 KVA surge protection driver. Deliver overall excellent illumination & comfort in high ceiling areas with no harmful UV & IR radiation.



These stylish cylindrical down lights are available in two different sizes, features a 6W COB LED with a 680 lumen output with a Warm White colour temperature of 3000K, as well as an impressive 50,000-hour lifespan. These are perfect as a replacement for traditional surface mounted lighting and comes with a pre-installed driver, giving you total control over the look and feel.





Ankur ROUND CUBIC downlight is an attractive surface mounted fitting that offers a subtle contemporary accent with a simple design and pop of classic colour to the interior.

A stylish alternative to traditional downlighters, the CUBIC comes in round and square with several gorgeous colour combinations to suit any interior.

Available Collar Shades

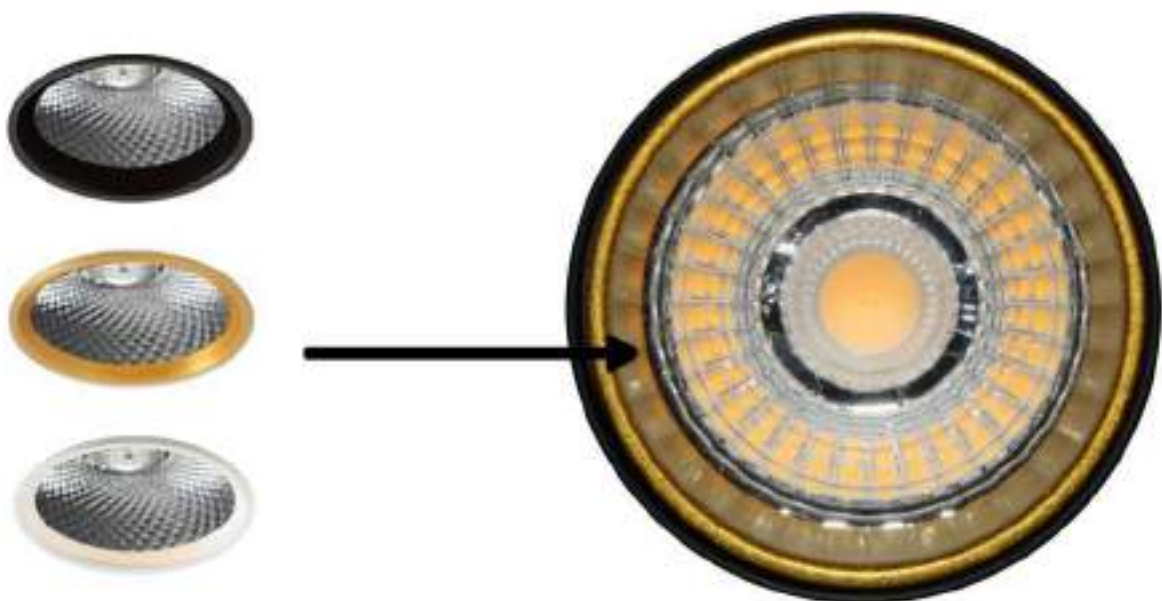



ANKUR XSL - LED - IP/9248 6W - 8W

Wattage: 6W-8W
CCT: 3000K / 4000K / 6500K
Material: aluminium
Rotates: Fixed
Spot headadjust: Fixed

Lamp: COB
Reflector angle: 14°/24°/36°/60°
Size: Ø: 55mm H: 76mm



Available color:



ANKUR XSL - LED - IP/9432 6W - 8W, 12W - 15W

Wattage: 6W - 8W, 12W - 15W
CCT: 3000K / 4000K / 6500K
Material: aluminium
Rotates: Fixed
Spot headadjust: Fixed

Lamp: COB
Reflector angle: 14°/24°/36°/60°
Size: Ø: 55mm H: 110mm



Available color:





90 + CRI



2700K - 6500K



Available in
Wall Wash &
Multiple Beam
Spreads



1000 lumens - 2600 lumens



AVAILABLE IN 2 SIZES





ANKUR XSL - LED - IP/9336 18W - 20W

Wattage: 18W - 20W
CCT: 3000K / 4000K / 6500K
Material: aluminium
Rotates: Fixed
Spot headadjust: Fixed

Lamp: COB
Reflector angle: 14°/24°/36°/60°
Size: Ø: 75mm H: 110mm



Available color:



ANKUR XSL - LED - IP/9336 25W - 30W

Wattage: 25W - 30W
CCT: 3000K / 4000K / 6500K
Material: aluminium
Rotates: Fixed
Spot headadjust: Fixed

Lamp: COB
Reflector angle: 14°/24°/36°/60°
Size: Ø: 100mm H: 120mm

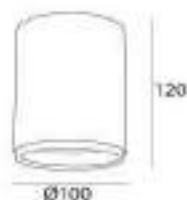

Available color:





Available in 2 sizes

Dia: 63mm & 75mm

Height: 110mm & 130mm





Product features

- Stylish design, more elegant and cost saving.
- Good heat dissipation performance (Aluminium).
- No UV Radiation, no glaring.
- Save more electricity cost, easy installation.
- Unique optical design, no light pollution, uniform light field.
- Strict raw material inspection, testings comply with international standards.
- 50,000 hours lifespan, 10 times longer than traditional lamp.
- High quality driver.



MULTI PURPOSE



EXCELLENT
High performance COB
and high CRI.

Can be converted into
pendant light.

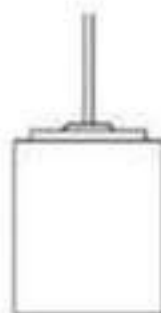
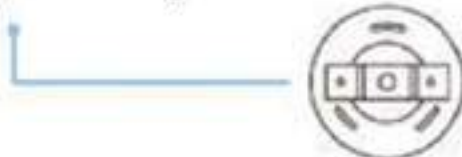



ANKUR XSL - LED - IP/9240 6W

Wattage: 6W
CCT: 3000K / 4000K / 6500K
Material: aluminium
Rotates: Fixed
Spot headadjust: Fixed

Lamp: COB
Reflector angle: 14°/24°/36°/60°
Size: Ø: 63mm H: 110mm



Available color:



ANKUR XSL - LED - IP/9132 12W - 15W

Wattage: 12W - 15W
CCT: 3000K / 4000K / 6500K
Material: aluminium
Rotates: Fixed
Spot headadjust: Fixed

Lamp: COB
Reflector angle: 14°/24°/36°/60°
Size: Ø: 75mm H: 130mm



Available color:



ANKUR XHL - LED - IP/300 12W - 15W

ACCESSORIES

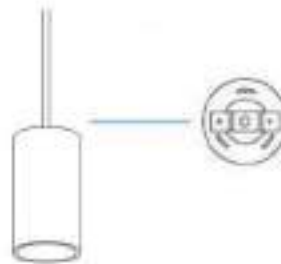

BRAIDED WIRE

CUBIC

SQUARE SURFACE

MOUNTED



Aesthetically designed Surface mounted Square CUBIC lights with pressure die-cast aluminium housing having effective heat sink for better thermal. Equipped with Anti-glare UV Stabilized poly carbonate diffuser in white powder coated finish with energy efficient electronic driver with 25 KVA surge protection driver. Deliver overall excellent illumination & comfort in high ceiling areas with no harmful UV & IR radiations .



Product features

- Stylish design, more elegant and cost saving.
- Good heat dissipation performance (Aluminium).
- No UV Radiation, no glaring.
- Save more electricity cost, easy installation.
- Unique optical design, no light pollution, uniform light field.
- Strict raw material inspection, testings comply with international standards.
- 50,000 hours lifespan, 10 times longer than traditional lamp.
- High quality driver.





Applications

Airport, Bathroom, Bedroom, Car Park, Cinema, Gallery, Garage, Hospital, Hotel, Kitchen, Meeting Room, Museum, Office, Restaurant, School, Shopping Mall, Sitting Room etc.

Available colors





Available Sizes



BIG-IP/9126 15W



SMALL-IP/9239 6W

Multi - Purpose



Excellent

High performance COB
and high CRI.

Can be converted into
pendant light.

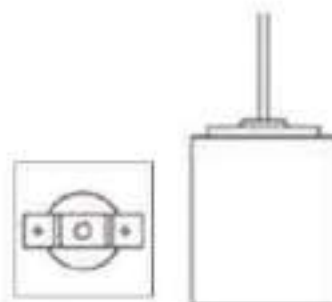
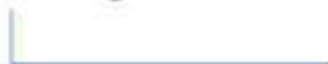



ANKUR XSL - LED - IP/9239 6W SURFACE

Wattage: 6W
CCT: 3000K / 4000K / 6500K
Material: aluminium
Rotates: Fixed
Spot headadjust: Fixed

Lamp: 1x COB
Reflector angle: 14°/24°/36°/60°
Size: L: 50mm B: 50mm H: 75mm

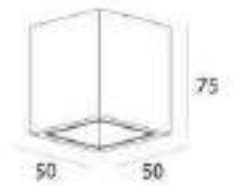

Available color:



ANKUR XSL - LED - IP/9126 15W SURFACE

Wattage: 15W
CCT: 3000K / 4000K / 6500K
Material: aluminium
Rotates: Fixed
Spot headadjust: Fixed

Lamp: 1x COB
Reflector angle: 14°/24°/36°/60°
Size: L: 75mm B: 75mm H: 100mm

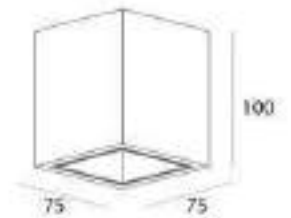

Available color:



ANKUR XHL - LED - IP/9126 15W WITH HANGING SYSTEM

ACCESSORIES

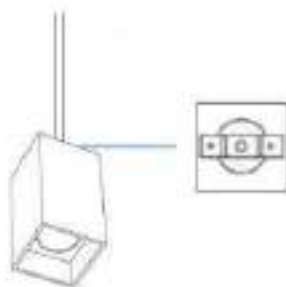

BRAIDED WIRE

Downlight

COB & Diffuser **9441**



These recessed down lights are great to fit any space and provide a lighting setup that is comfortable, manageable and ambient. The lights are a fresh design that allow you to adjust their position according to your needs. These are made to last and their high durability and resilience is a class apart. They are easy to install and a simple way to beautify your area.



Diffuser Lens



Clear Glass Lens





Ambient lighting



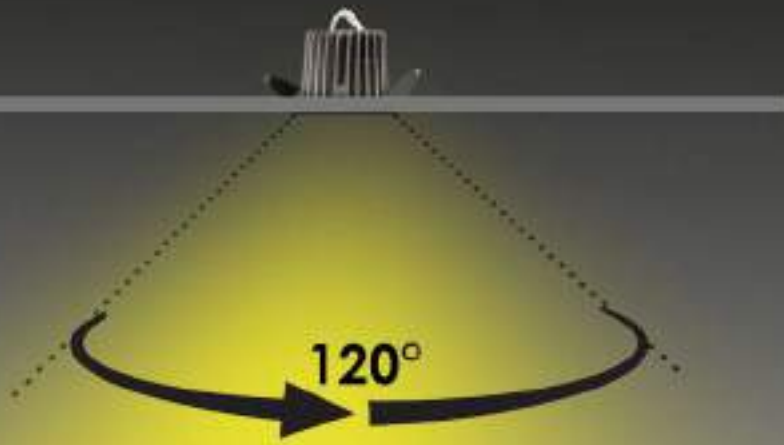

Ambient lighting

One of the most conventional types of lighting is Ambient light. This kind of lighting creates a subtle and soft glow that covers your room that is perfect for you to work without causing a piercing glare.

It is vital to note that ambient light helps to create the ideal space that one needs to unwind and relax after a stressful day at work.





Accent lighting



Accent Lighting

To attract the eye to a single focal point, accent focused lights do exactly that. Accent lighting is a way that you can add style and drama to your home.

When highlighting dull places, use accent lights to help you illuminate the parts you want on show. Spaces that have artwork, bookcases, displays, furniture pieces, collections are best-suited places for these lights.

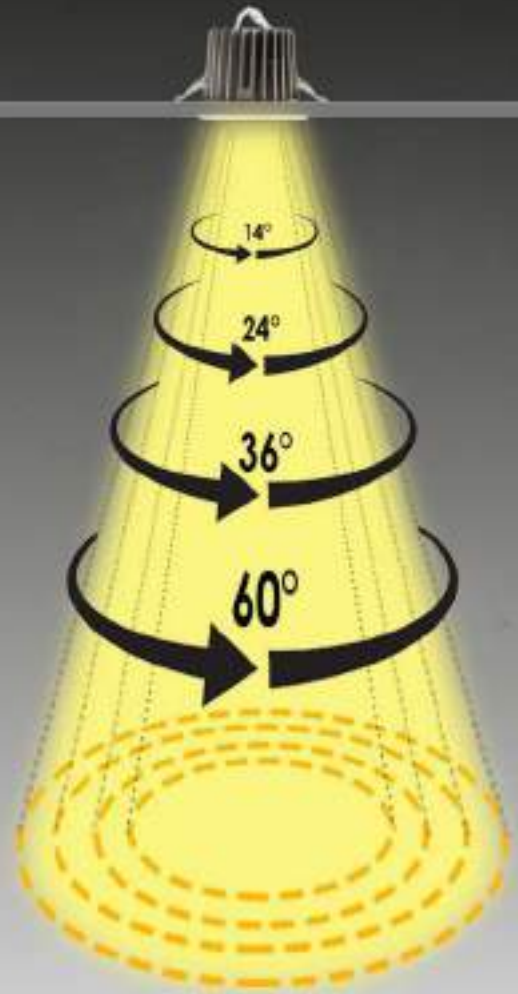

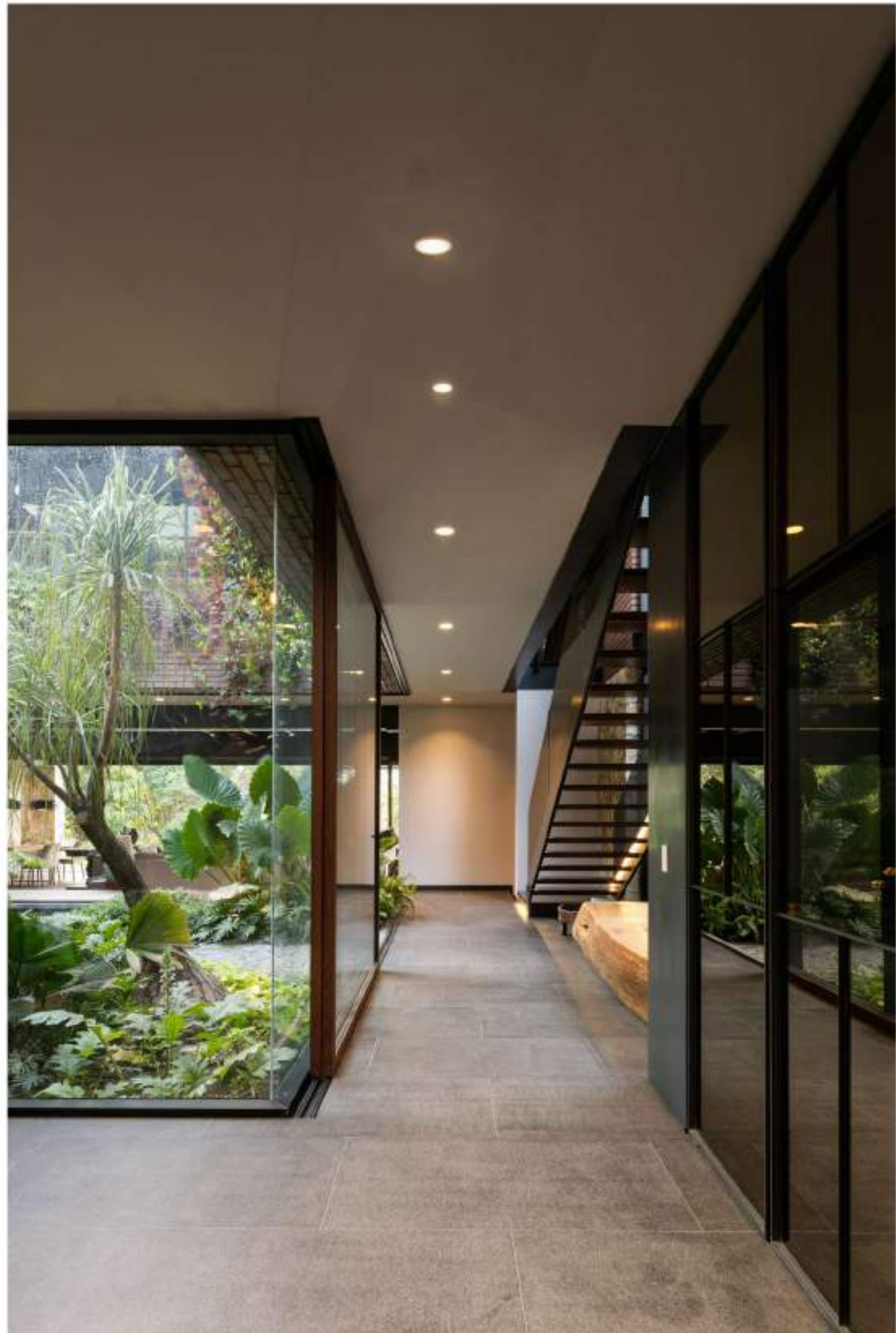



ANKUR XRL - LED - 9441 25W-30W COB

Wattage: 25W-30W
CCT: 3000K / 4000K / 6500K
Material: aluminium
Rotates: Fixed
Spot headadjust: Fixed

Lamp: COB
Reflector angle: 14°/24°/36°/60°
Size: Ø: 110mm H: 85mm
Cutout: Ø98mm

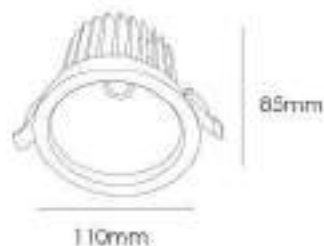

Available color:



WH



BK



SV



ANKUR XRL - LED - 9441 25W-30W Diffuser

Wattage: 25W - 30W
CCT: 3000K / 4000K / 6500K
Material: aluminium
Rotates: Fixed
Spot headadjust: Fixed

Optics: Polycarbonate Diffuser
Reflector angle: 120°
Size: Ø: 110mm H: 85mm
Cutout: Ø98mm

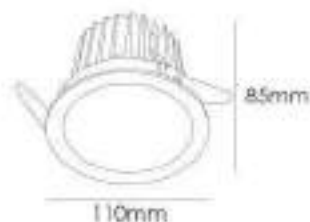

Available color:



WH



BK



SV



DOWNLIGHTS

9028B, 9028A, 9026A, 9027A



The light has excellent color performance, and can effectively improve lighting quality of the space.

PRODUCT DESCRIPTION



MATERIAL DESCRIPTION:

All of the product are made of Aluminium Alloy and Die-casting material which is consist of superior quality of molding and high density.

PRECISION TECHNOLOGY:

The Aluminium Alloy Surface will use UV paint to process and it is not easy to oxidation and rust.

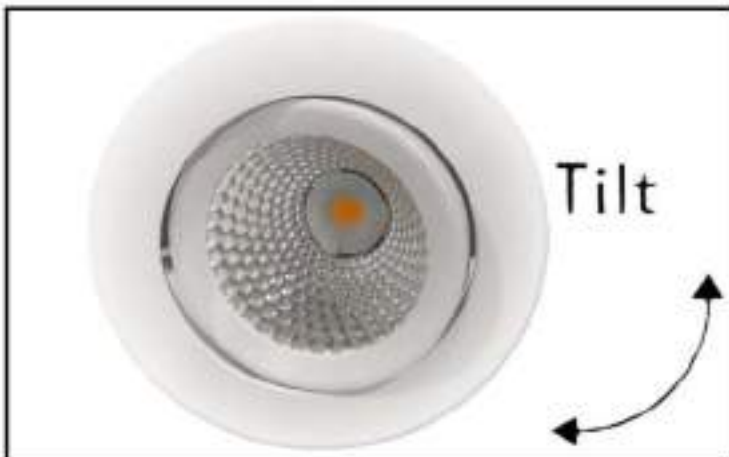

Radiator technology:

Chips are fixed in the radiator directly with the thermal paste. The thermal resistance of the radiator is very small, and it will have good thermal conductivity with up to 176w/mk; cooling area, the scientific air convection design, good cooling effect.

OPTICAL TECHNOLOGY:

We pay more attention in professional optical design, and try our best to maintain the accuracy of light distribution.





ANKUR XRL-LED-IP 9028B, 9028A, 9026A, 9027A



Ankur downlighter series

Part of a family of multiple downlights. Fully adjustable and providing a range of outputs, The luminaire offers a choice of beam angles (including a narrow 10° & 24° beam angle for accenting), color rendering options, a trimless version and accessories. The luminaire has a lumen maintenance of 50,000 hours



H: 60mm ⌀: 86mm
H: 80mm ⌀: 105mm
H: 85mm ⌀: 128mm
H: 85mm ⌀: 150mm

Characteristics

Location	Interior/Exterior
Fixation	Ceiling Recessed
Lumen Per watt	105/115/125
Colour Temperature	2700K/3000K/6000K
Operating Voltage	90-270V
Lighting Angle	14°, 24°, 36°, 60°
Efficiency	>87%
PF	>-0.95

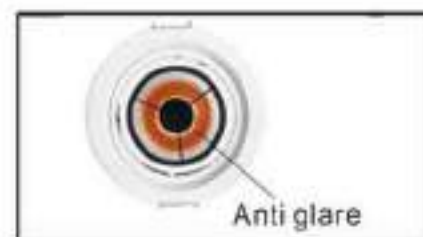
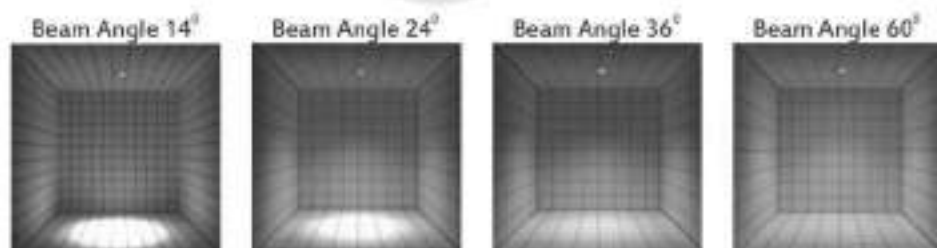
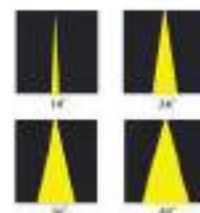

Adjustable, compact, delicate. With a classic black and white surface treatment. Vertical direction can be rotated to 35°



The light has excellent color performance, and can effectively improve lighting quality of the space.



ANKUR XRL-LED-IP/9028B 10-12W

Material: Pressure-Die-cast-Aluminium body duly powder coated,
Rotates: 2-ways
Fixation: Ceiling Recessed

Lamp: COB 1x10W / 1X12W / 1X15W
3000K / 4000K / 6000K
CRI 80/90

Reflector angle: 14°, 24°, 36°, 60°
AC220V ~50/60Hz

Size: Ø 102

Cutout: Ø86mm H:60mm

Available Color

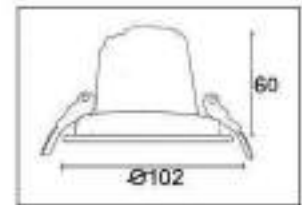

ANKUR XRL-LED-IP/9028A 25W

Material: Pressure-Die-cast-Aluminium body duly powder coated,
Rotates: 2-ways
Fixation: Ceiling Recessed

Lamp: COB 1x25W
3000K / 4000K / 6000K
CRI 80/90

Reflector angle: 14°, 24°, 36°, 60°
AC220V ~50/60Hz

Size: Ø125mm

Cutout: Ø105mm H:80mm

Available Color

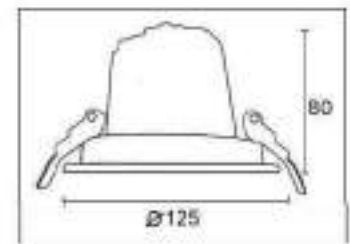

ANKUR XRL-LED-IP/9026A 30W

Material: Pressure-Die-cast-Aluminium body duly powder coated,
Rotates: 2-ways
Fixation: Ceiling Recessed

Lamp: COB 1x30W
3000K / 4000K / 6000K
CRI 80/90

Reflector angle: 14°, 24°, 36°, 60°

Size: Ø148mm

Cutout: Ø128mm H:85mm

Available Color

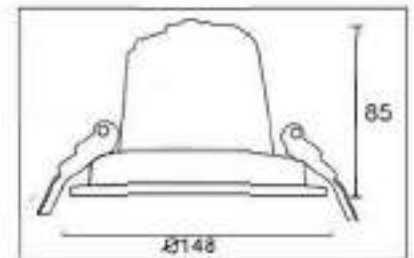

ANKUR XRL-LED-IP/9027A 40W

Material: Pressure-Die-cast-Aluminium body duly powder coated,
Rotates: 2-ways
Fixation: Ceiling Recessed

Lamp: COB 1x40W
3000K / 4000K / 6000K
CRI 80/90

Reflector angle: 14°, 24°, 36°, 60°
AC220V ~50/60Hz

Size: Ø170mm

Cutout: Ø150mm H:85mm

Available Color

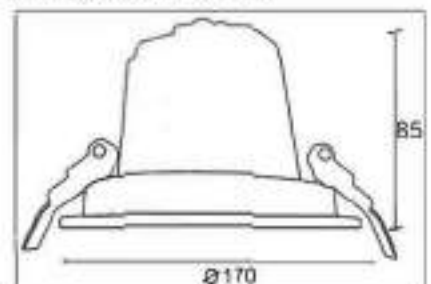

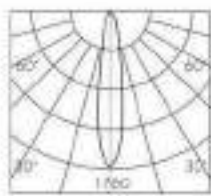

Hght	Dia	Dist
1	0.36	1700
2	0.55	435
3	0.84	185
4	1.12	105
5	1.4	60

LED 6W 3000K 14°

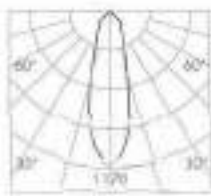

Hght	Dia	Dist
1	0.44	1124
2	0.66	281
3	1.32	124
4	1.75	70
5	2.2	45

LED 6W 3000K 24°

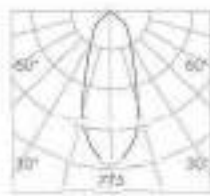

Hght	Dia	Dist
1	0.55	752
2	1.33	160
3	1.95	84
4	2.6	47
5	3.25	30

LED 6W 3000K 36°

Beam Angle 14°

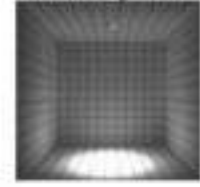

Beam Angle 24°



Beam Angle 36°

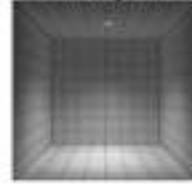

Beam Angle 60°

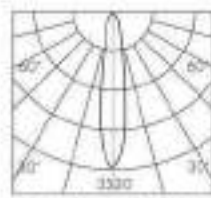
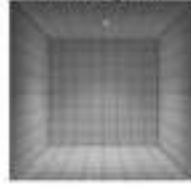

Hght	Dia	Dist
1	0.28	3430
2	0.56	850
3	0.84	377
4	1.12	212
5	1.4	135

LED 12W 3000K 14°

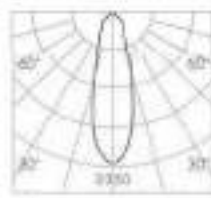

Hght	Dia	Dist
1	0.44	2248
2	0.66	562
3	1.32	251
4	1.75	140
5	2.2	90

LED 12W 3000K 24°

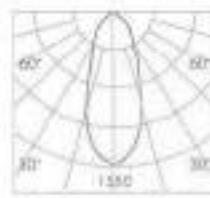

Hght	Dia	Dist
1	0.55	1525
2	1.33	361
3	1.95	189
4	2.6	107
5	3.25	71

LED 12W 3000K 36°

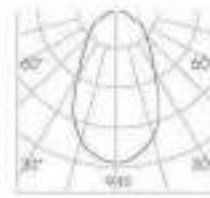

Hght	Dia	Dist
1	1.11	934
2	2.22	203
3	3.33	112
4	4.44	63
5	5.55	37

LED 12W 3000K 60°

Beam Angle 14°

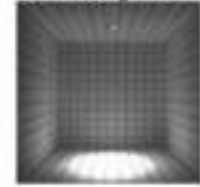

Beam Angle 24°



Beam Angle 36°

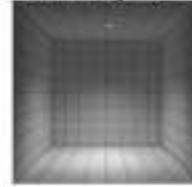

Beam Angle 60°

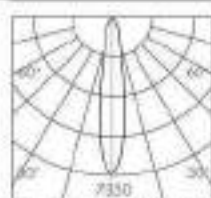
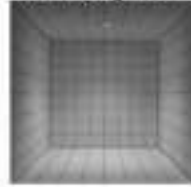

Hght	Dia	Dist
1	0.28	8090
2	0.56	1515
3	0.84	672
4	1.12	378
5	1.4	240

LED 25W 3000K 14°

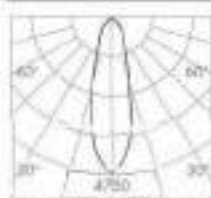

Hght	Dia	Dist
1	0.44	4000
2	0.66	1000
3	1.32	444
4	1.75	250
5	2.2	160

LED 25W 3000K 24°



Hght	Dia	Dist
1	0.55	2550
2	1.33	657
3	1.95	343
4	2.6	197
5	3.25	132

LED 25W 3000K 36°

Beam Angle 14°

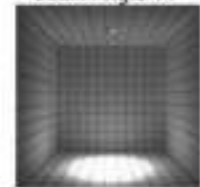

Beam Angle 24°

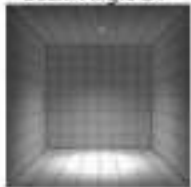

Beam Angle 36°



Beam Angle 60°

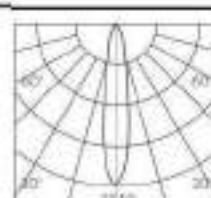

Hght	Dia	Dist
1	0.28	8090
2	0.56	1515
3	0.84	672
4	1.12	378
5	1.4	240

LED 25W 3000K 14°

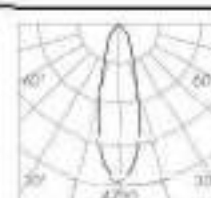

Hght	Dia	Dist
1	0.44	4000
2	0.66	1000
3	1.32	444
4	1.75	250
5	2.2	160

LED 25W 3000K 24°

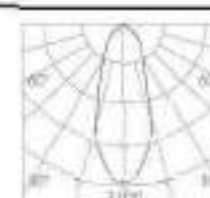

Hght	Dia	Dist
1	0.55	2550
2	1.33	657
3	1.95	343
4	2.6	197
5	3.25	132

LED 25W 3000K 36°

Beam Angle 14°

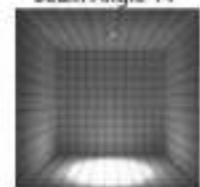

Beam Angle 24°



Beam Angle 36°



Beam Angle 60°



REX PANELS



LED recess mounted aesthetically designed panels equipped with anti-glare UV stabilized polycarbonate diffuser allowing 95% of uniform lux spread over. In built heat sink for better thermal management to provide a bright and even light in an energy-saving way.



It makes an extraordinary light for minimally style spaces. You can utilise this light for studio lighting or to illuminate a great deal of area, and that's just the beginning. The strength and versatility originate from the best quality material utilised for its making. With its impressive performance, this model will leave you in awe.





- Environment protection
- Safe and easy to install
- No danger of broken glass
- Low power consumption LED Downlight
- High efficiency, Energy save more than 70%~80%
- Ultra Thin design Downlight



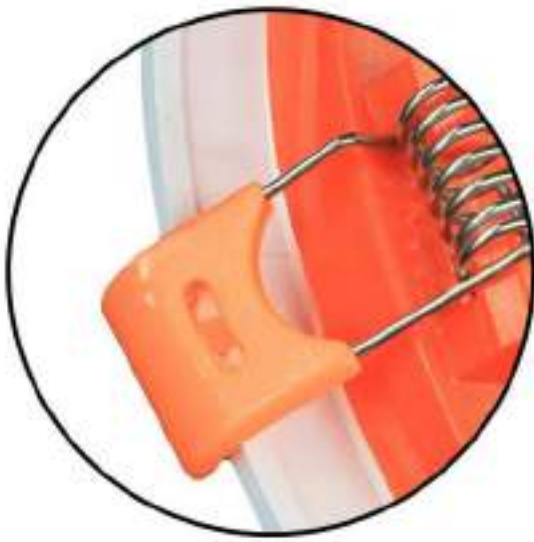

MOVABLE CLAMPS



SLEEK DESIGN



NARROW FRAME



IN- BUILT DRIVER

Available color Temperatures

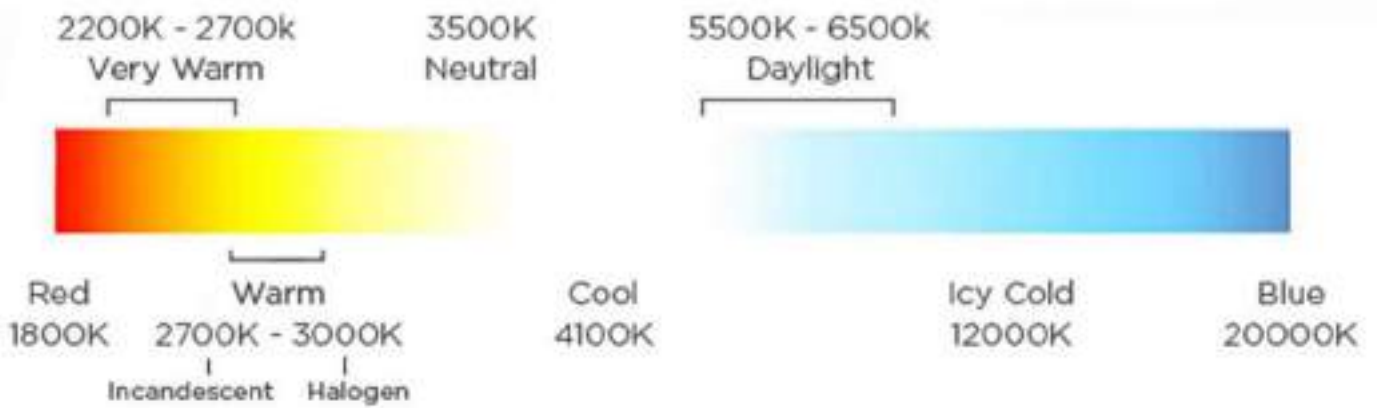
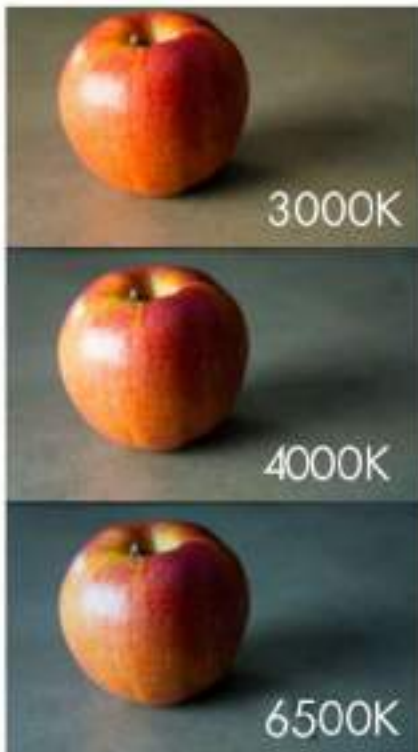

CRI

Good light quality



CRI 80 or above

Bad light quality



CRI 70 or below



ANKUR XRL - LED - IP/9089 10W

Wattage: 10W
Material: PC
Optics: Polycarbonate Diffuser
CRI: 80/90
Colour Temperature: 3000K/ 4000K/ 6500K
Reflector angle: 120°
Outer Dia: 120mm
Cut Out Dia: 100mm
Height : 25mm



Available Colours:



ANKUR XRL - LED - IP/9090 15W

Wattage: 15W
Material: PC
Optics: Polycarbonate Diffuser
CRI: 80/90
Colour Temperature: 3000K/ 4000K/ 6500K
Reflector angle: 120°
Outer Dia: 165mm
Cut Out Dia: 150mm
Height : 25mm

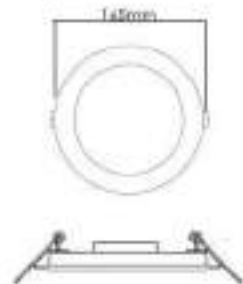

Available Colours:





ANKUR XRL-LED-IP/9075 10W

Wattage: 10W
Material: PC
Optics: Polycarbonate Diffuser
CRI: 80/90
Colour Temperature: 3000K/ 4000K/ 6500K
Reflector angle: 120°
Size: L:120mm
B:120mm
Cut Out :100X100mm
Height : 25mm
Available Colours:

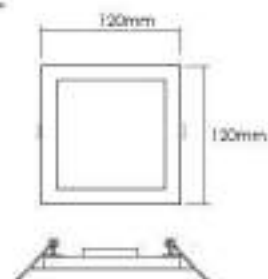

ANKUR XRL-LED-IP/9076 15W

Wattage: 15W
Material: PC
Optics: Polycarbonate Diffuser
CRI: 80/90
Colour Temperature: 3000K/ 4000K/ 6500K
Reflector angle: 120°
Size: L:165mm
B:165mm
Cut Out : 155X155mm
Height : 25mm
Available Colours:

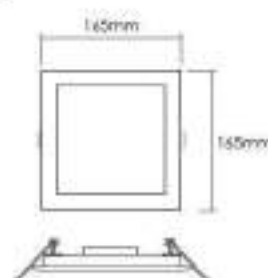

Gimbal

0017 - 1lp, 2lp, 3lp



Embrace long-lasting and quality lighting with the help of Ankur's Gimbal Downlight Casing. It has been made with the strongest aluminium which ensures that wear and tear of your lighting solution won't ever be an issue. This excellent casing fits perfectly with Ankur's premium indoor LED lighting collection including the Ankur LED Module Lamps.

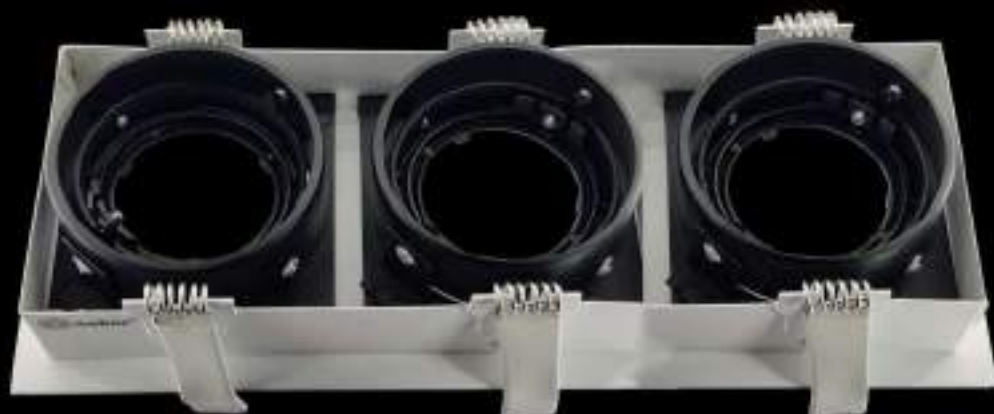

ANKUR XRL - HG - IP/GM - 603 - 3LP

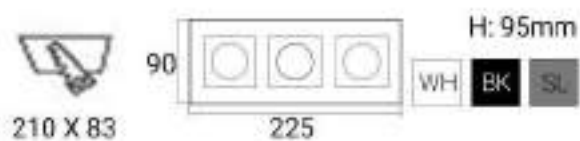

ANKUR XRL - HG - IP/GM - 602 - 2LP

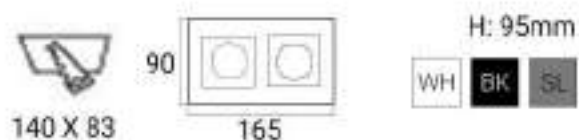

ANKUR XRL - HG - IP/GM - 601 - 1LP



ANKUR XRL - HG - IP/GM - 601GY - 1LP



ANKUR XRL - HG - IP/GM - 602GY - 2LP

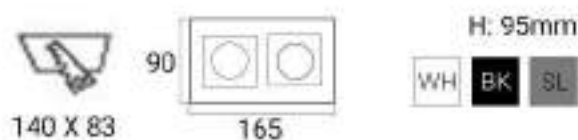

ANKUR XRL - HG - IP/GM - 603GY - 3LP

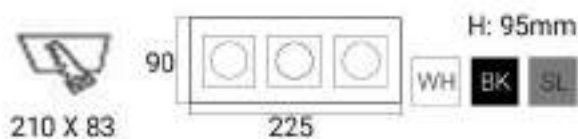



Installation Steps

- ① First we need to insert the casing part into the ceiling



- ③ Place the lamp inside the casing so that it gets locked with the rings.

- ② Connect the wires to the driver.



- ④ Installation is completed, Light is ready to use.



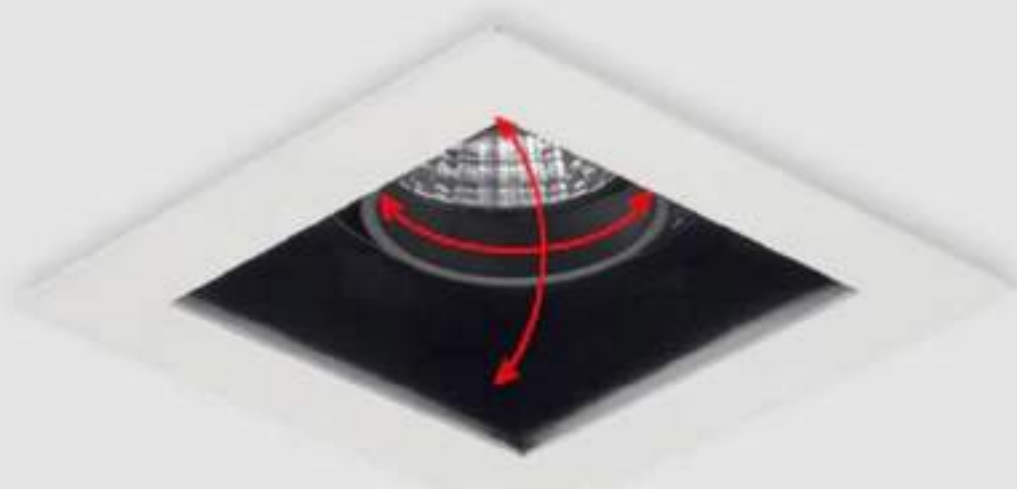

Multi - angle adjustment



6000K



4000K



3000K

Die-cast aluminum lamp





The small and comfortable size will allow you to make your room more spacious and add more decor accessories. The lights are manufactured with our highest quality materials and have long-lasting durability.

ANKUR L8003 MR16 12W MODULE LAMP



Dimension (D x H): 50mm x 75mm
 Wattage: 6W / 12W
 Voltage: 100-30 AC0V
 Lamp Type: LED
 LED Type: COB
 Optics: Clear glass
 CRI: >80
 Colour Temperature: 3000K / 4000K / 6500K
 Body Finish: Black / White

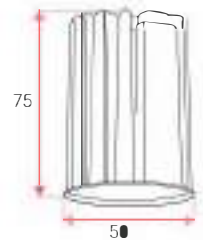

ANKUR L8003 MR16 6W MODULE LAMP



Dimension (D x H): 50mm x 55mm
 Wattage: 3W / 6W
 Voltage: 100-30 AC0V
 Lamp Type: LED
 LED Type: COB
 Optics: Clear glass
 CRI: >80
 Colour Temperature: 3000K / 4000K / 6500K
 Body Finish: Black / White

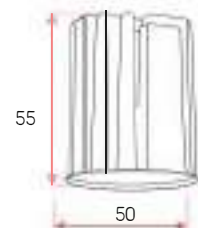

ANKUR XRL - HG - IP/GM - 601 - 1LP

Material: Aluminium
 Rotates: 355°
 Spot head adjust: 4 Side
 Adjustable

Lamp: Zr
 Wattage: 2x7W
 Color Temperature: 4000K
 Lumens Per Watt: 110lm/w x 14 = 1540lm
 CRI: 90

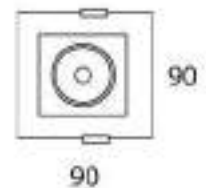

Reflector angle: 36°
 AC20V - 50/60Hz
 Size: L:90mm x W:90mm x H:95mm
 Cutout: L: 83mm x W: 83mm

Body finish: WH BK SL

ANKUR XRL - HG - IP/GM - 602 - 2LP

Material: Aluminium
 Rotates: 355°
 Spot head adjust: 4 Side
 Adjustable

Lamp: Zr
 Wattage: 2x7W
 Color Temperature: 4000K
 Lumens Per Watt: 110lm/w x 14 = 1540lm
 CRI: 90

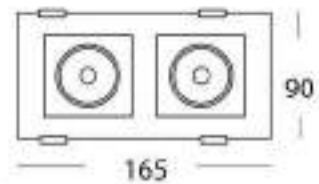

Reflector angle: 36°
 AC20V - 50/60Hz
 Size: L:165mm x W:90mm x H:95mm
 Cutout: L: 140mm x W: 83mm

Body finish: WH BK SL

ANKUR XRL - HG - IP/GM - 603 - 3LP

Material: Aluminium
 Rotates: 355°
 Spot head adjust: 4 Side
 Adjustable

Lamp: Zr
 Wattage: 3x7W
 Color Temperature: 4000K
 Lumens Per Watt: 110lm/w x 21 = 2310lm
 CRI: 90

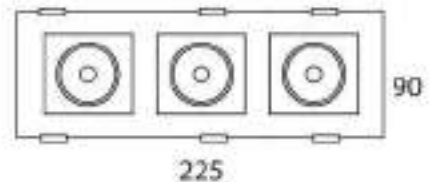

Reflector angle: 36°
 AC20V - 50/60Hz
 Size: L:225mm x W:90mm x H:95mm
 Cutout: L: 210mm x W: 83mm

Body finish: WH BK SL

TETRA

Tini & MR16 Casings

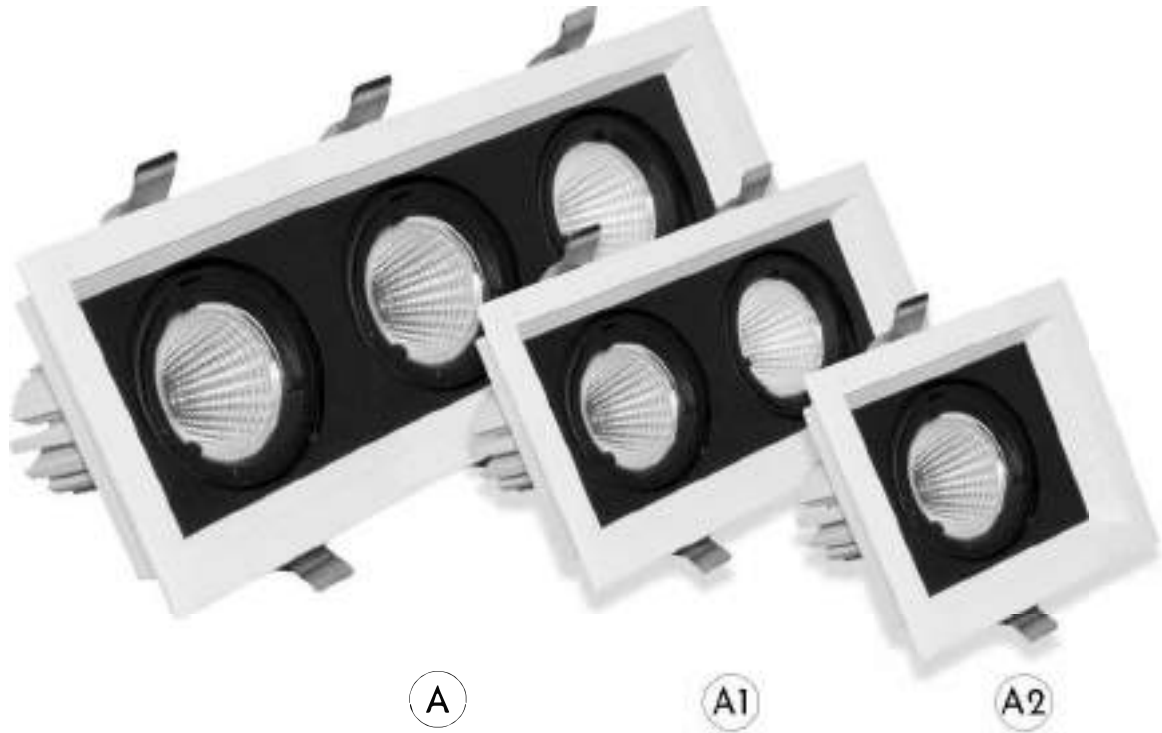

A

A1

A2



B1

B2

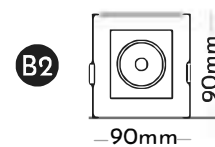
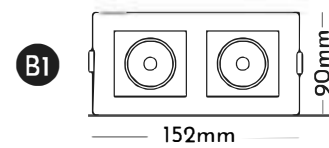
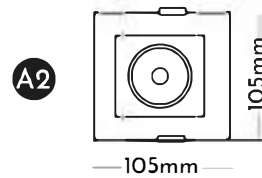
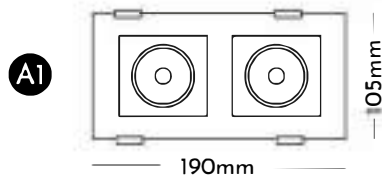
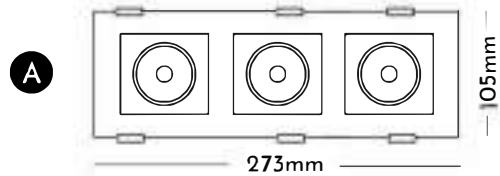

Tetra tini



Miniaturised LED downlight for high-performance accent lighting. Compact design with minimalist look. Precise light distribution with no stray light and excellent glare control. Housing made of die-cast aluminium. These fixtures are great for highlighting artwork.



ADJUSTABLE- 4 SIDES

Tetra tini recessed downlight provides a clear, effective light focused where it is needed most, perfect for areas like Restaurants, malls and areas with high ceilings. It has two directional lamps allowing variable lighting.



Small & Elegant

Tetra Tini- 1LP



Tetra Tini- 2LP





Original design
Powder - coat

COB Chip
CRI > 90

Power and quality of LED Driver

Professional optical design
High reflectivity, precise angle

Aluminium body design heat - sink for
optimal thermal management of LED chips





High Brightness COB chips



COB



$Ra \geq 90$



$Ra \leq 80$

ANKUR XRL LED 9352 9W 1LP



Material: Aluminium
Rotates: 355°
Spot head adjust: 4 Side
Adjustable

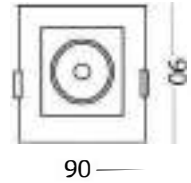

Lamp: Module lamp
Wattage: 9W
Color Temperature: 3000K / 4000K / 6500K
Lumens Per Watt: 105lm / 110lm / 115lm
CRI: 90

Reflector angle: 12° / 24° / 36° / 60°
AC20V - 50/60Hz
Size: L:90mm x W:90mm x H:55mm
Cutout: L: 72mm x W: 72mm

Body finish: WH

ANKUR XRL LED 9353 12W



Material: Aluminium
Rotates: 355°
Spot head adjust: 4 Side
Adjustable

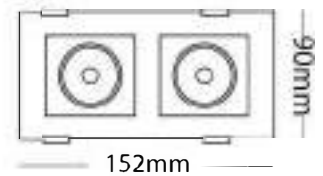

Lamp: Module lamp
Wattage: 2x6W
Color Temperature: 3000K / 4000K / 6500K
Lumens Per Watt: 105lm / 110lm / 115lm
CRI: 90

Reflector angle: 12° / 24° / 36°
AC20V - 50/60Hz
Size: L:152mm x W:90mm x H:55mm
Cutout: L: 134mm x W: 72mm

Body finish: WH

Tetra

1 LP, 2LP & 3LP



Aesthetically designed LED MR module lamp (ZR) to fit into various modular casings, providing the different light colours, wattages and offering energy savings of up to 80%, equipped with high grade aluminium PDC housing with the bigger fins for the efficient thermal management.



Lamp can be replaced from the front ring of the casing , without opening the whole fitting from the ceiling.



ADJUSTABLE- 4 SIDES



12° 24° 36° 60°



Small & Elegant







The small and comfortable size will allow you to make your room more spacious and add more decor accessories. The lights are manufactured with our highest quality materials and have long-lasting durability.

ANKUR L8003 MR16 12W MODULE LAMP



Dimension (D x H): 50mm x 75mm
 Wattage: 6W / 12W
 Voltage: 100-30 AC0V
 Lamp Type: LED
 LED Type: COB
 Optics: Clear glass
 CRI: >80
 Colour Temperature: 3000K / 4000K / 6500K
 Body Finish: Black / White

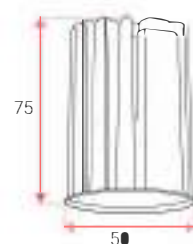

ANKUR L8003 MR16 6W MODULE LAMP



Dimension (D x H): 50mm x 55mm
 Wattage: 3W / 6W
 Voltage: 100-30 AC0V
 Lamp Type: LED
 LED Type: COB
 Optics: Clear glass
 CRI: >80
 Colour Temperature: 3000K / 4000K / 6500K
 Body Finish: Black / White

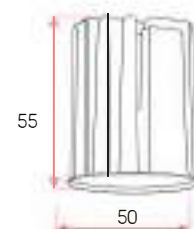

ANKUR TETRA 1LP / 9356



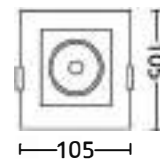

Material: Aluminium
Rotates: 355°
Spot head adjust: tiltable



Lamp: Module Lamp
12W
2700K/3000K/ 4000K/ 6500K
Lumens Per Watt: 95lm/105lm/110lm/115lm
CRI 80/90

Reflector angle: 12°/ 24°/ 36°/ 60°
AC20V - 50/60Hz
Size: L:105mm x W:105mm x H:100mm
Cutout: L: 90mm x W: 90mm

Available Colours:  WH  BK  SV

ANKUR TETRA 2LP / 9357



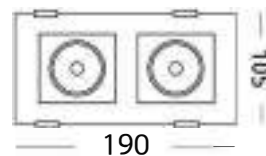

Material: Aluminium
Rotates: 355°
Spot head adjust: tiltable



Lamp: Module Lamp
2x12W
2700K/3000K/ 4000K/ 6500K
Lumens Per Watt: 95lm/105lm/110lm/115lm
CRI 80/90

Reflector angle: 12°/ 24°/ 36°/ 60°
AC20V - 50/60Hz
Size: L:190mm x W:105mm x H:105mm
Cutout: L: 175mm x W: 90mm

Available Colours:  WH  BK  SV

ANKUR XRL LED 9358 MR-16 3LP



Material: Aluminium
Rotates: 355°
Spot head adjust: tiltable

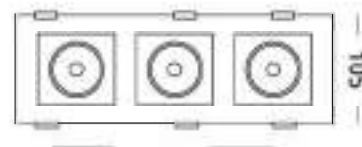

Lamp: Module Lamp
2x12W
2700K/3000K/ 4000K/ 6500K
Lumens Per Watt: 95lm/105lm/110lm/115lm
CRI 80/90

Reflector angle: 12°/ 24°/ 36°/ 60°
AC20V - 50/60Hz
Size: L:190mm x W:105mm x H:105mm
Cutout: L: 175mm x W: 90mm

Available Colours:  WH  BK  SV

Tetra - Grande

TLP, 2LP & 3LP



Whether you need your office better lit or your walkway that needs better light, this comfortable design is the perfect model for you. It is easy to fit in any space and comes with a lot of freedom for installation purposes. The design will perform with high durability because of quality material used during the manufacturing. This downlight will brighten up any wall and any ceiling with complete ease and versatility.

Adjustable



The Downlight can be tilted or rotated to get the perfect angle to focus light on a particular area of your room. A short heat sink allows an installation into any space, no matter how narrow, and a sturdy aluminium profile offers brilliant heat dissipation.



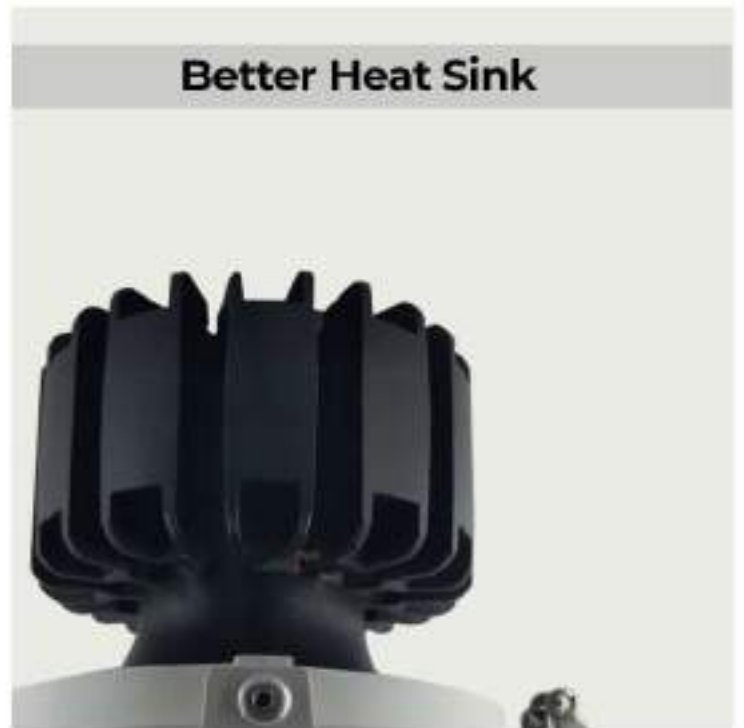
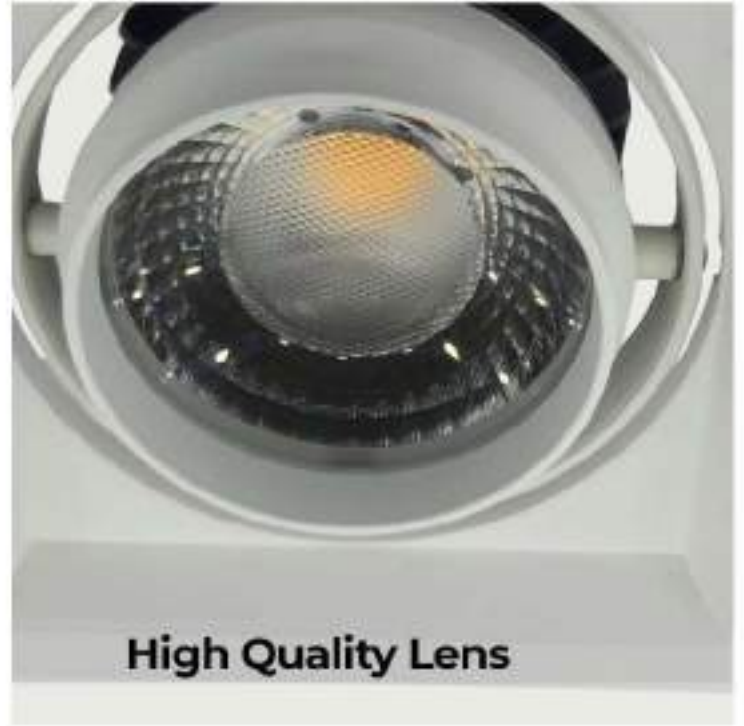
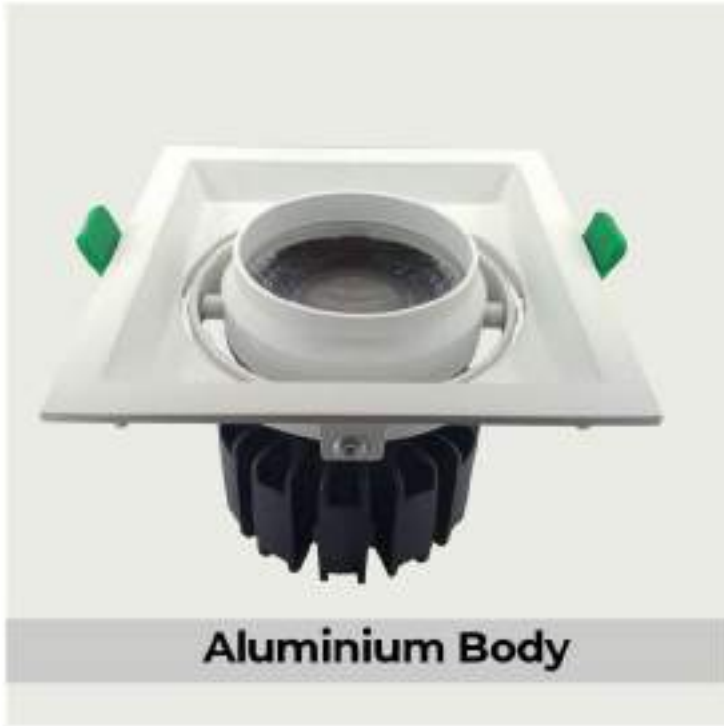

FEATURES

- Ankur Recessed LED Downlight, Build-in Anti Glare Spot Light.
- Extreme minimalist design, build for perfectionists.
- Aluminum lamp body, high performance on heat radiation.
- Integrative LED design is the key to achieve long lifespan with better heat conduction.







Tetra - 3LP



Tetra - 2LP



Tetra - 1LP



ANKUR XRL - LED IP/9324 1LP 20W / 30W



Material: Aluminium
Rotates: All 4 Sides
Spot head adjust: Tilttable
Lamp: Cob
Wattage: 20W / 30W
Color Temperature: 3000K / 4000K / 6500K
AC20V - 50/60Hz
Size: L:140mm x W:140mm x H:112mm
Cutout: L: 130mm X H:130mm

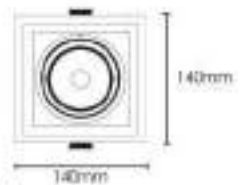

Available Colour:



ANKUR XRL - LED IP/9324 2LP 2 x 20W / 2 x 30W



Material: Aluminium
Rotates: All 4 Sides
Spot head adjust: Tilttable
Lamp: Cob
Wattage: 2x20W / 2x30W
Color Temperature: 3000K / 4000K / 6500K
AC20V - 50/60Hz
Size: L: 285mm x W:140mm x H:112mm
Cutout: L: 252mm x W: 130mm

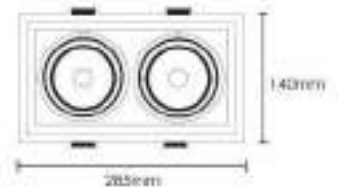

Available Colour:



ANKUR XRL - LED IP/9324 3LP 3 x 20W / 3 x 30W



Material: Aluminium
Rotates: All 4 Sides
Spot head adjust: Tilttable
Lamp: Cob
Wattage: 3x20W / 3x30W
Color Temperature: 3000K / 4000K / 6500K
AC20V - 50/60Hz
Size: L:420mm x W:140mm x H:112mm
Cutout: L: 387mm x W:130mm

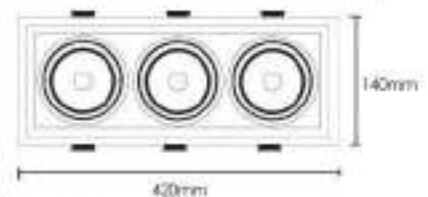

Available Colour:



Value



LED COB Downlights are a perfect replacement for halogen bulb. These recess mounted circular COB LED downlights equipped with die-cast aluminium housing in white powder coating finish, specially designed heat sink, anti glare diffuser and separate energy efficient electronic driver. Available in White and Black finish. Suitable for both suspended and concrete ceilings.



Available in two sizes

Widely used in hotels, stores, homes, museums and some other indoor places as the important spot lighting scenarios, retrofit work or new installation.





- EASY INSTALLATION
- SAVE YOUR MONEY
- SIMPLE & SAFE DIY
- EASY TO REPLACE



Anti-glare

Controlling glare at sight, so as to make eyes feels comfortable and create pure light.

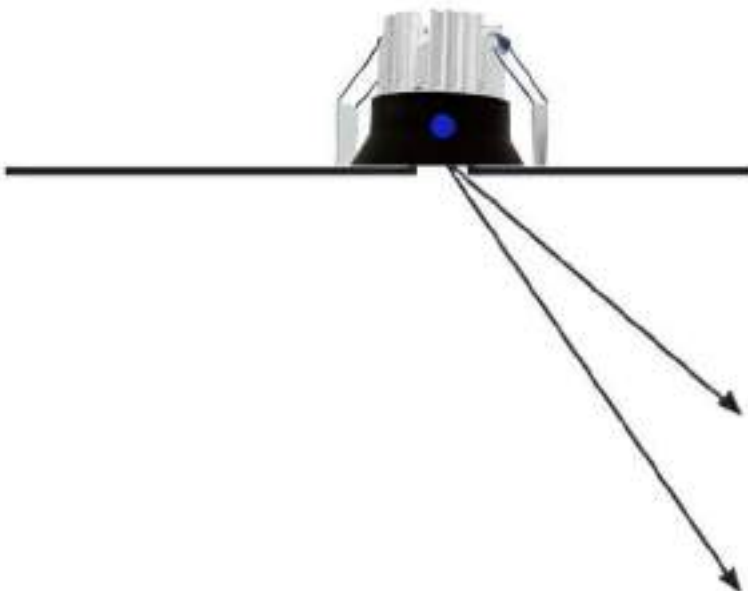



Ø92mm

Ø80mm

Fixed downlight with deeply recessed light source for excellent cut-off angle and glare control.



Available - Different Beam angles

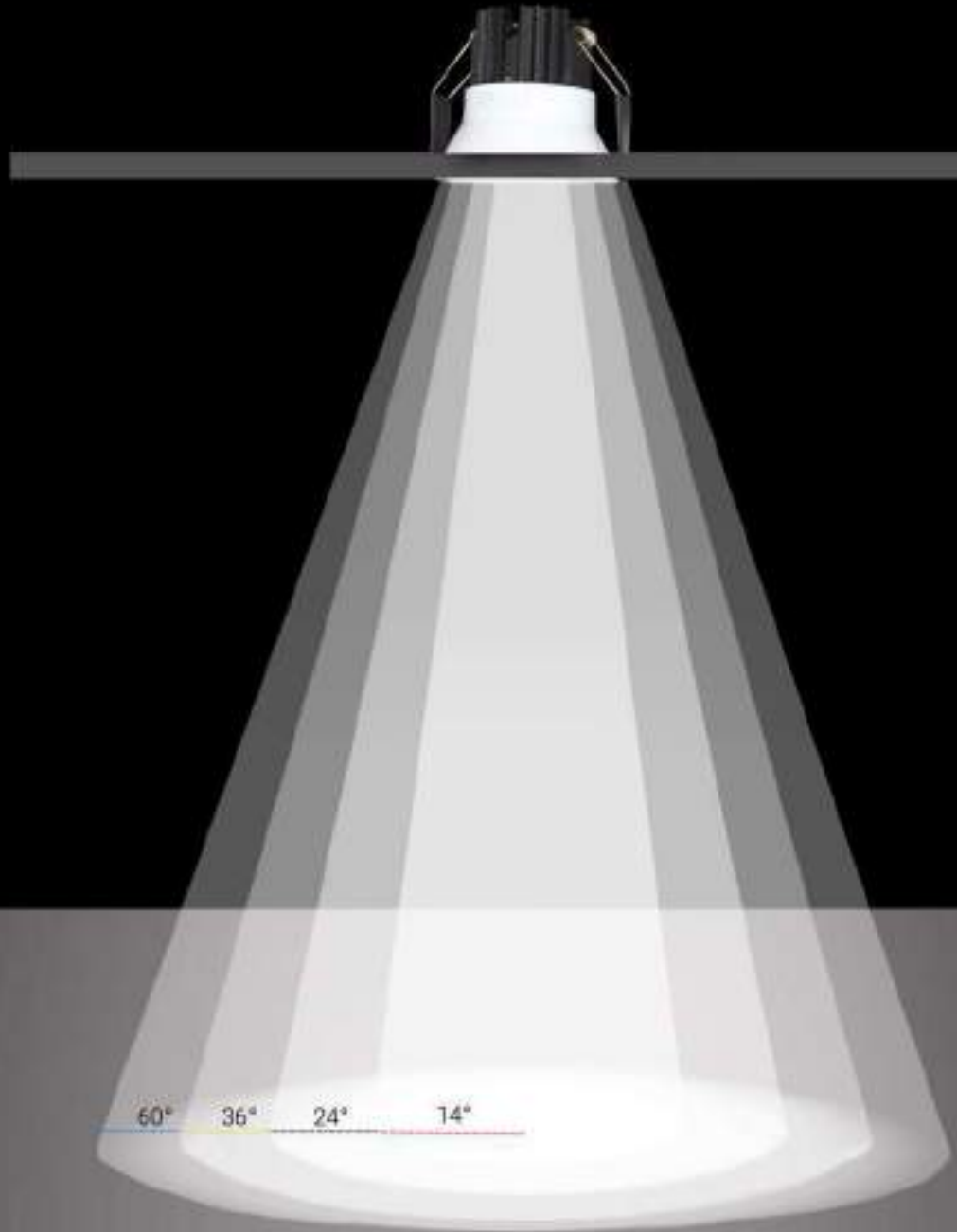



ANKUR VALUE - 92 XRL LED IP/ 9496 12W

Wattage: 12W
CCT: 3000K / 4000K / 6500K
Material: aluminium
Rotates: Fixed
Spot headadjust: Fixed

Lamp: 1x COB

Size: Ø: 92mm H: 90mm
Cutout: Ø 82mm

Available color:



WH



BK



SV



90mm

Ø92mm



ANKUR VALUE - 80 XRL LED IP/ 9495 6W

Wattage: 6W
CCT: 3000K / 4000K / 6500K
Material: aluminium
Rotates: Fixed
Spot headadjust: Fixed

Lamp: 1x COB

Size: Ø: 80mm H: 75mm
Cutout: Ø 75mm

Available color:



WH



BK



SV



75mm

Ø80mm

Zoom

FAMILY



This COB LED lets you adjust the direction of light anywhere you want. It has a perfect beam angle that is able to illuminate the wider area. The light is of warm white color and its quality and durability are unmatched.

ZOOM - Mini





ZOOM - Medio



Components



Applications

- Residential
- Hotels
- Restaurants
- Used as a Spot Light for a large display.



ZOOM - Grande





1 355° horizontal rotation with 70° vertical tilt

2 Industry best lumen output with efficacy more than 100 Lm/W

3 Controlled light beam without glare with reflector & lens option



ANKUR XRL - LED - 4331



Material: Aluminium die-cast
Rotates: 355°
Spot head adjust: 70°

Lamp: COB
Wattage: 6W/12W
CCT: 3000K / 4000K / 6500K
CRI > 90
Reflector angle: 14°/24°/36°/60°
AC220V - 50/60Hz
Size: Ø90 mm H:80mm CO: 83mm
Available Colour:



ANKUR XRL - LED - 4333B



Material: Aluminium die-cast
Rotates: 355°
Spot head adjust: 70°

Lamp: COB
Wattage: 25W
CCT: 3000K / 4000K / 6500K
CRI > 90
Reflector angle: 14°/24°/36°/60°
AC220V - 50/60Hz
Size: Ø 140mm H: 122mm CO:127mm
Available Colour:

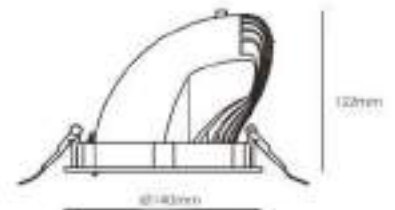

ANKUR XRL - LED - 4335



Material: Aluminium die-cast
Rotates: 355°
Spot head adjust: 70°

Lamp: COB
Wattage: 35W
CCT: 3000K / 4000K / 6500K
CRI > 90
Reflector angle: 14°/24°/36°/60°
AC220V - 50/60Hz
Size: Ø 163mm H: 120mm CO: 147mm
Available Colour:

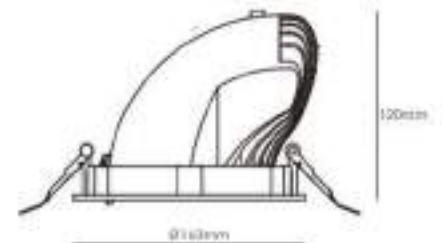

ANKUR LARK SERIES



High flexibility , Complete Serialization

A very complete and compact **LARK** lamp series with single lamp, double lamp and triple lamp series, effectively preventing glare with optimum lighting. The light has excellent color performance and dramatically improve lighting quality of the space.



High precision design, better fit into the decoration ,effectively prevent glare. The light has excellent color performance and can effectively improve lighting quality on the displayed products.





Rotates-360°



Low Depth- 85mm



Glare free

Ankur downlight series

Part of a family of multiple downlights. Fully adjustable and providing a range of outputs. The luminaire offers a choice of beam angles (including a narrow 10° beam angle for accenting), color rendering options, a thin trim version and choice of accessories. The luminaire has a lumen maintenance of 50,000 hours.

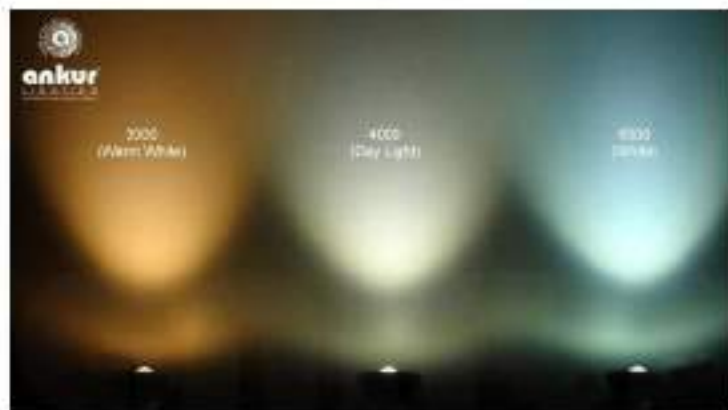
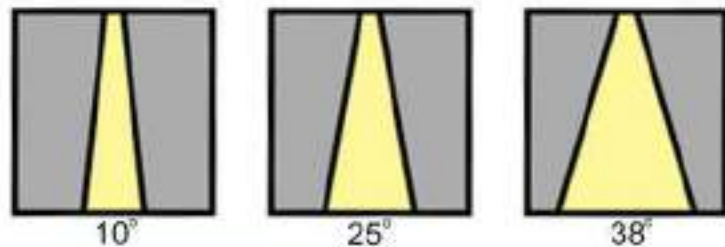
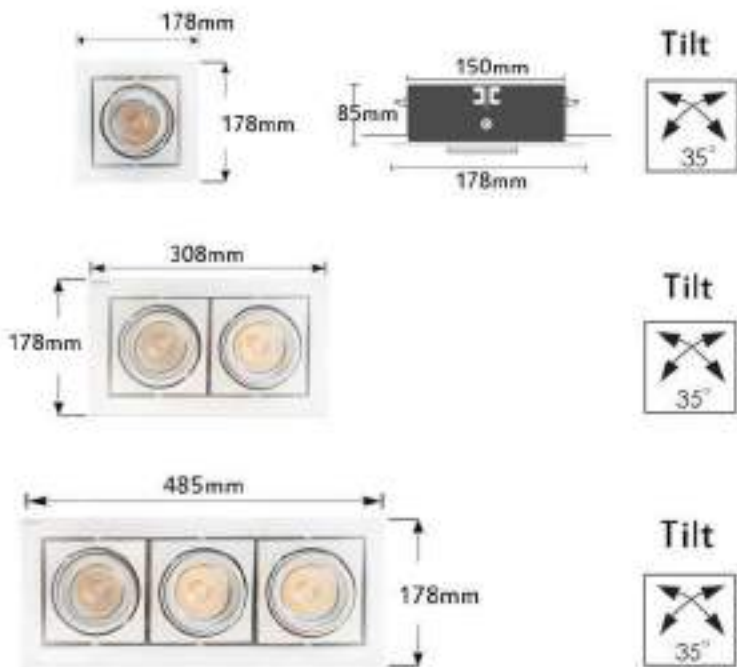

Accessories:



Honeycomb louver
Available for most luminaires in the range, these louvers enhance visual comfort by controlling unwanted light spill.



Softening lens
Designed to create a smoother, softer beam edge, these lenses are available for most luminaires in the range.



Snoot
Available for the multi series, a snoot can be used to reduce the field angle and control unwanted glare.

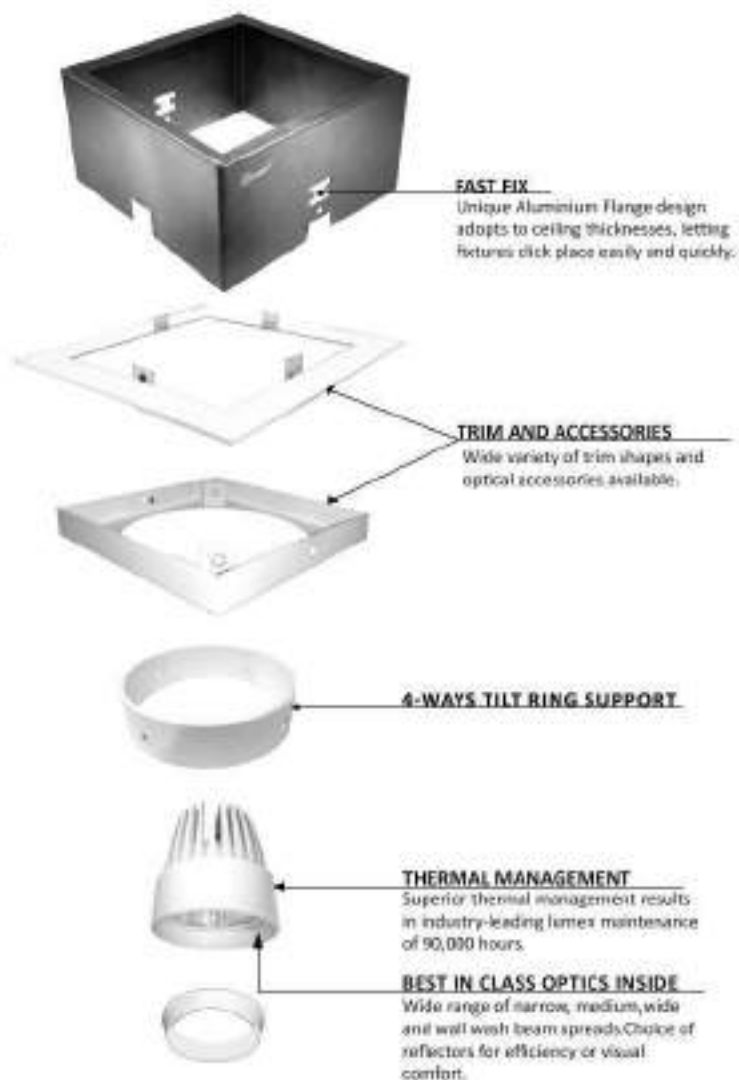

ANKUR XRL-LED IP/9325 1LP

Material: Pressure Die-cast aluminium+MS Box duty powder coated

Rotates: 4 side rotation

Built in anti-glare snoot.

Lamp: COB 1x20W/1X30W
3000K / 4000K /6000K
CRI 80/90

Reflector angle: 10° / 25° / 38°

AC220V~50/60Hz

Size: L:178mm W:178mm H:85mm

Cutout: L:150mm W:150mm

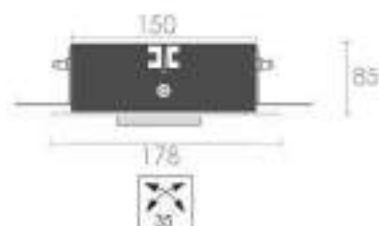

Available color:



ANKUR XRL-LED IP/9325 2LP

Material: Pressure Die-cast aluminium+MS Box duty powder coated

Rotates: 4 side rotation

Built in anti-glare snoot.

Lamp: COB 2x20W / 2x30W
3000K / 4000K /6000K
CRI 80/90

Reflector angle: 10° / 25° / 38°

AC220V~50/60Hz

Size: L:308mm W:178mm H:85mm

Cutout: L:280mm W:150mm



Available color:



ANKUR XRL-LED IP/9325 3LP

Material: Pressure Die-cast aluminium+MS Box duty powder coated

Rotates: 4 side rotation

Built in anti-glare snoot.

Lamp: COB 3x20W/3X30W
3000K / 4000K /6000K
CRI 80/90

Reflector angle: 10° / 25° / 38°

AC220V~50/60Hz

Size: L:485mm W:178mm H:85mm

Cutout: L:430mm W:150mm

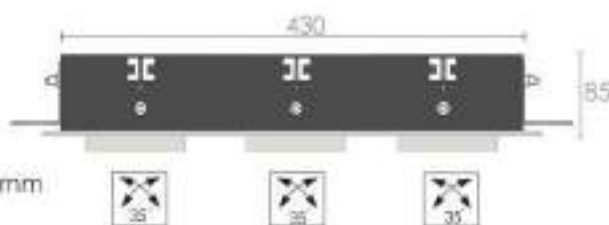

Available color:

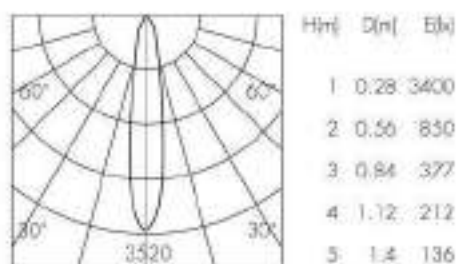

LED 3000K 10°

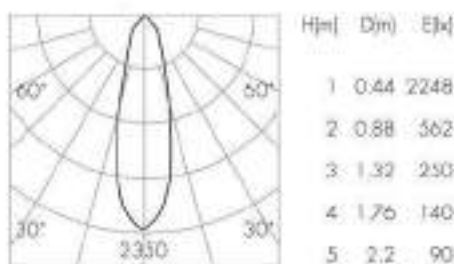

LED 3000K 25°

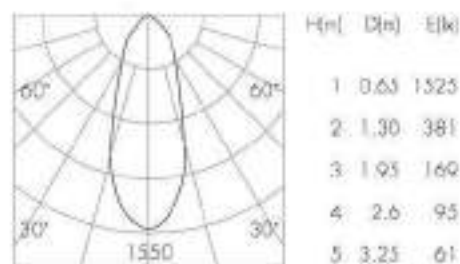

LED 3000K 38°

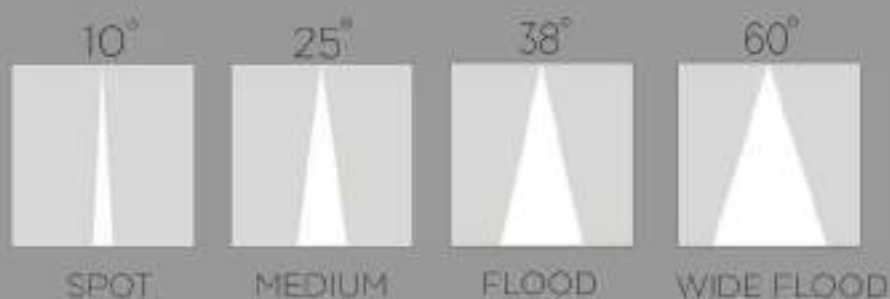
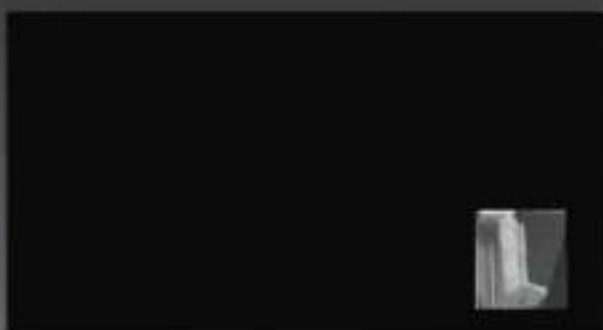

High flexibility , Complete Serialization

A very complete and compact **TRAZOR** lamp series with single lamp, double lamp and triple lamp series, effectively preventing glare with optimum lighting. The light has excellent color performance and dramatically improve lighting quality of the space.



Ankur downlight series

Part of a family of multiple downlights. Fully adjustable and providing a range of outputs. The luminaire offers a choice of beam angles (including a narrow 10° beam angle for accenting), color rendering options, a thin trim version and choice of accessories. The luminaire has a lumen maintenance of 50,000 hours.

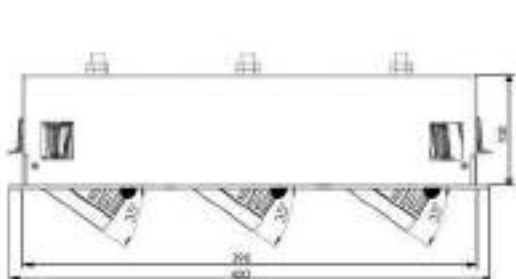
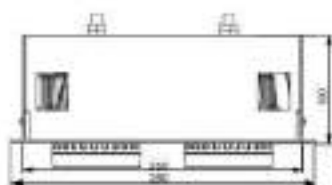
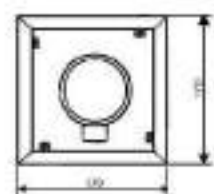

Tilt



10°

25°

38°

60°

Tilt



Tilt





ACCESSORIES:



Honeycomb louver

Available for most luminaires in the range, these louvers enhance visual comfort by controlling unwanted light spill.



Softening lens

Designed to create a smoother, softer beam edge, these lenses are available for most luminaires in the range.



Snoot

Available for the multi series, a snoot can be used to reduce the field angle and control unwanted glare.

CUTOUT SIZES:

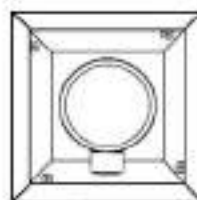

150 X 150

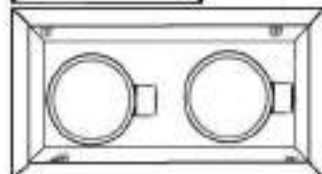

150 X 260

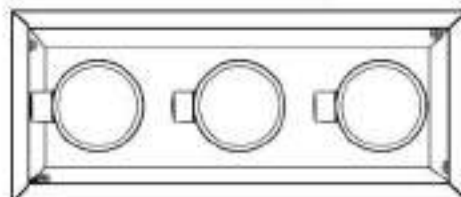

150 X 390

ANKUR XRL-LED-IP/9410 1LP

Material: Pressure Die-cast aluminium+MS Box duty powder coated
Built in anti - glare snoot
Rotates: 4 side rotation
Lamp: COB 1x20W/1X30W/1X40W
3000K / 4000K / 6000K
CRI 80/90
Reflector angle: 10° / 25° / 38° / 60°
Size: L:170mm W:170mm H:100mm
Cutout: L:150mm W:150mm



Available color:



ANKUR XRL-LED-IP/9411 2LP

Material: Pressure Die-cast aluminium+MS Box duty powder coated
Built in anti - glare snoot
Rotates: 4 side rotation
Lamp: COB 2x20W/2X30W/2X40W
3000K / 4000K / 6000K
CRI 80/90
Reflector angle: 10° / 25° / 38° / 60°
Size: L:260mm W:170mm H:100mm
Cutout: L:260mm W:150mm



Available color:



ANKUR XRL-LED-IP/9412 3LP

Material: Pressure Die-cast aluminium+MS Box duty powder coated
Built in anti - glare snoot
Rotates: 4 side rotation
Lamp: COB 3x20W/3X30W/3X40W
3000K / 4000K / 6000K
CRI 80/90
Reflector angle: 10° / 25° / 38° / 60°
Size: L:420mm W:170mm H:100mm
Cutout: L:390mm W:150mm

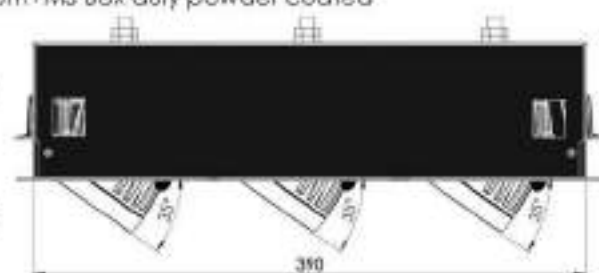

Available color:



Beam Angle 10°

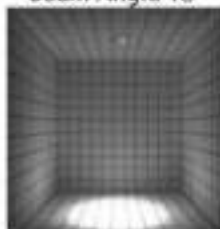

Beam Angle 25°



Beam Angle 38°



Beam Angle 60°

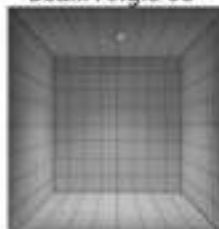

Desire



A beautiful contemporary style LED Wall Lamp, this a sleek and modern lighting solution for your home and office interiors.



The elegant and sophisticated design of the wall lights offers warm lighting, and will effortlessly enhance your home interiors. It is an eclectic lighting fixture for your living room, bedroom or dining room.





It is a nice **Backlit Wall Light** protect eyes from glare.







ANKUR DESIRE LED WALL LIGHT

Wattage: 6-9W

Material: Die Cast Aluminium Body

Optics: Poly-carbonate

CRI: 80/90

Colour Temperature: 3000K

Lumens Per watt: 100lm

Diameter: 165mm

Height : 85mm

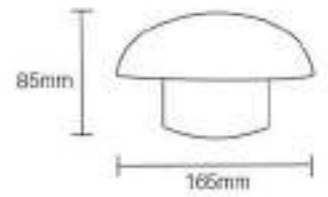

Available Colours:



WH



BK



SS



GD



RG



RING FOOT LIGHT

ankur[®]
L I G H T I N G
An ISO 9001-2008 Certified Company



ANKUR RING FOOT LIGHT



ANKUR Ring foot light Brighten up high foot-traffic areas like staircases and pathways with Stair Lighting and Step Lighting fixtures. Suitable for both indoor and outdoor stair lighting ideas, Low voltage LED stair and step lighting can add extra safety to your home and deck. Choose from complete stair lighting kits or unique step lighting designs to find the perfect addition to your space.

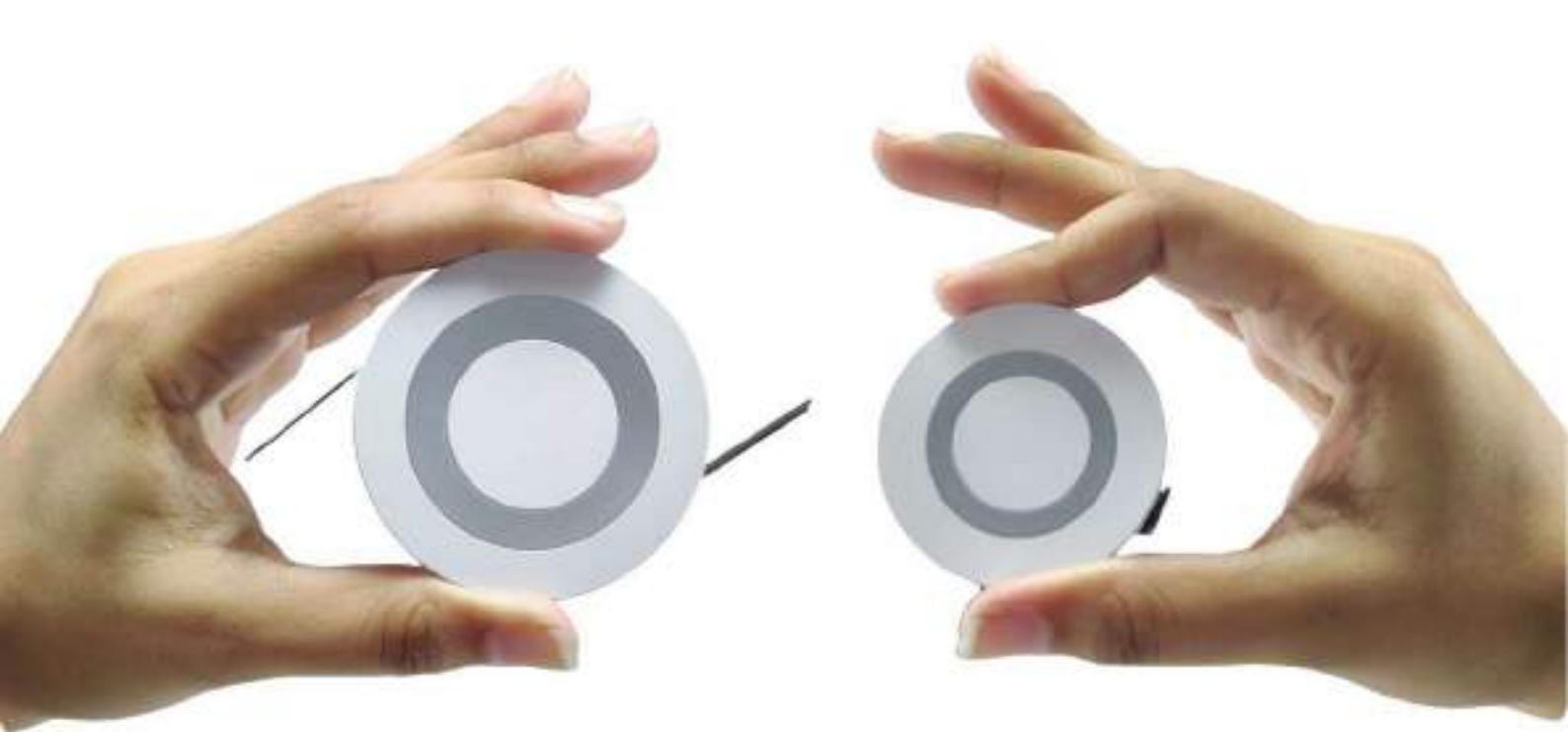

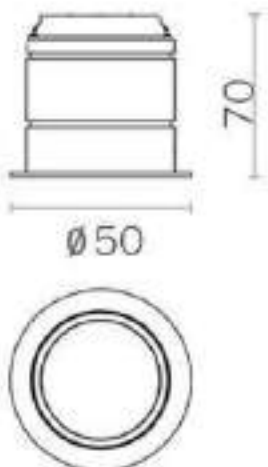
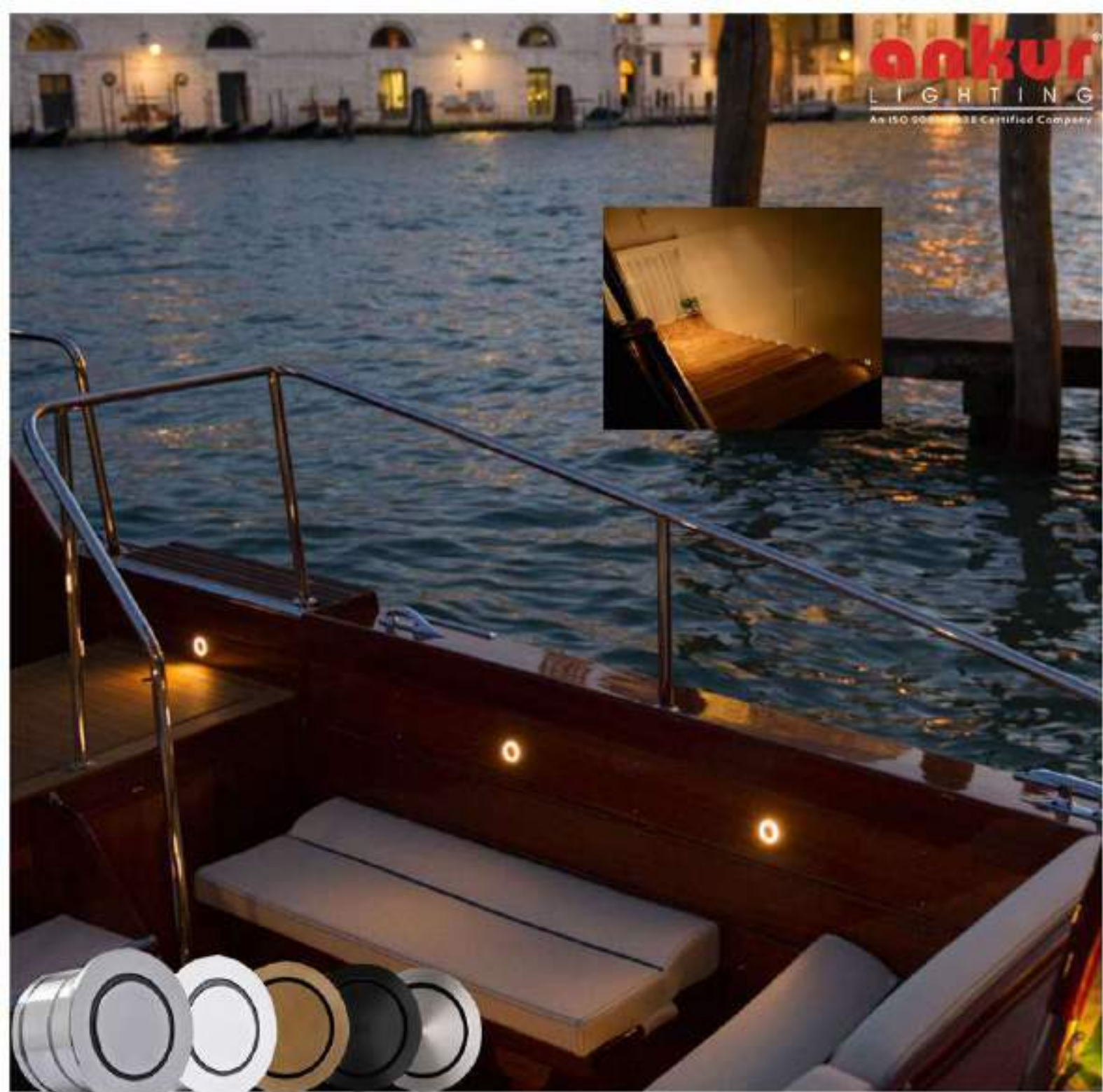

Ankur Ring Foot Light Series

Owing to a modernized infrastructure for trouble-free processing post-production & we are instrument in offering quality assured & Designer LED Foot Lights. Our offered product is manufactured under the guidance of vendor's skilled engineers with vast experience in this domain. The entire range is well designed from quality approved basic material and advanced logies. These lights are known for their highly durable low in maintenance and consumes less power



Applications:

1. Hardwood Flooring
2. Laminate
3. Carpet
4. Ceramic Tiles
5. Natural Stone
6. Quartz Flooring
7. Outdoor stair,plinth/floor light

Features:

1. IP65 protection against dust and moisture.
2. Energy saving (0.7W/pc)
3. Extreme long lifespan
4. Minimal heat development
5. UV resistant materials
6. Extremely low build-in depth (9mm)
7. Project specific colour solutions





Energy efficient 40,000 hour rated LED lamp light. Perfect for any area where low level lighting or safe way - finding is needed, such as hallways, stairways , lobbies, auditoriums and theater

Housing: Aluminium
Jacket: Plastic





ANKUR XOL-IP - 0084 3W

Wattage: 3W
Material: Housing Material Aluminium, Jacket Material Plastic
CRI: 80/90
Colour Temperature: 3000K/4000K/RGB
Lumens Output: 315lm /345lm
Power Factor (PF): >0.95
CRI: Ra > 80/ 90
Application Area: Indoor / Outdoor
IP: 65
Minimum Depth : 30mm
Outer Diameter: 50mm
Cutting Diameter: 38mm



Available Colours:



ANKUR XOL-IP - 0084 5W

Wattage: 5W
Material: Housing Material Aluminium, Jacket Material Plastic
CRI: 80/90
Colour Temperature: 3000K/4000K/RGB
Lumens Output: 315lm /345lm
Power Factor (PF): >0.95
CRI: Ra > 80/ 90
Application Area: Indoor / Outdoor
IP: 65
Minimum Depth: 20mm
Outer Diameter: 60mm
Cutting Diameter: 50mm



Available Colours:



NOTE:

- Plastic is originally 70mm but can be cut to minimum 46mm as per depth.
- For warm light or white LED depth is 46mm.
- For Blue/ Red/ Amber light depth is 70mm as we use external driver for such colour LED.



Magnetic Lights



THE QUALITY OF THE DETAILS

The magnetic absorption lamp can move and adjust freely after installation





MAGNETIC LAMP

Home improvement new choice, know you better

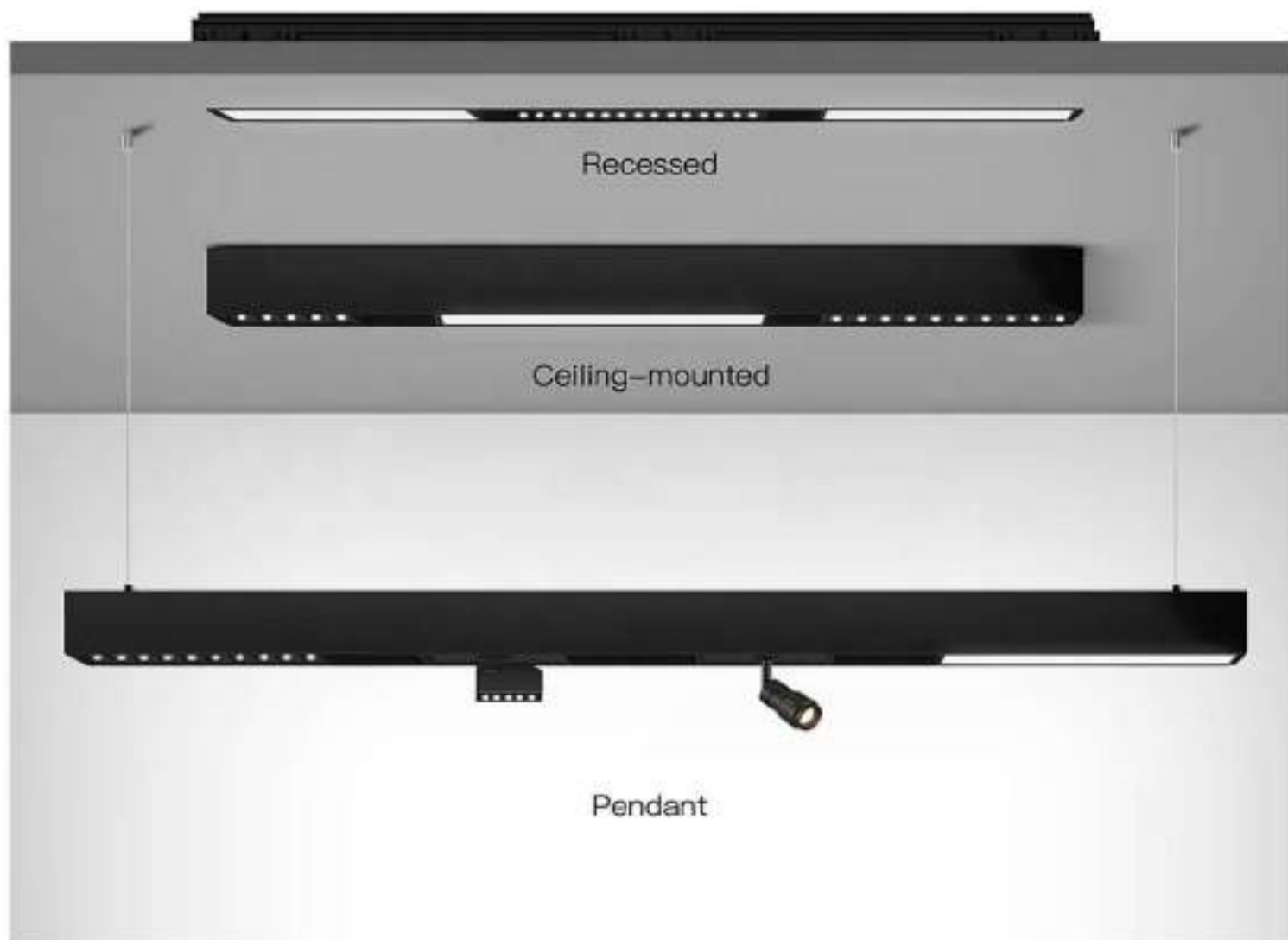

COMPONENTS OF MAGNET LAMPS

✘ All parts need to be purchased separately

Track + Drive + Lamp

Don't forget to buy Drive please !

Magnetic track

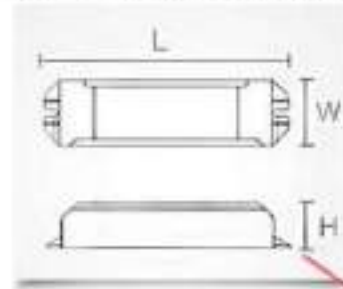

Drive

Can be connected without gap



1m/0.5m

Drive

Lamp



Lamp



You can choose the lamp by yourself



MAGNETIC FIXTURES - Overview





COB FOLDABLE LINEAR



XTR-M7104-10W



XTR-M7104-20W

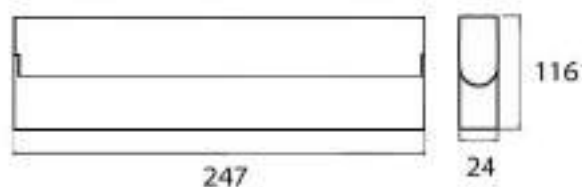
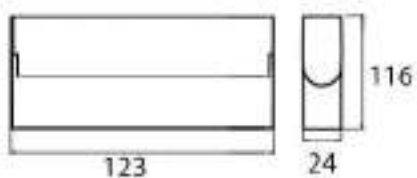

CREE OSRAM

Product Information	Input voltage	DC48V
	Power	10W / 20W
	Efficiency	70lm / W
	CRI	>80 >90
	Beam angle	15° / 30° / 45°
	CCT	3000K/4000K/5000K
	Available colour	black / white
	Certification	CE / ROHS



XTR-M8104-12W

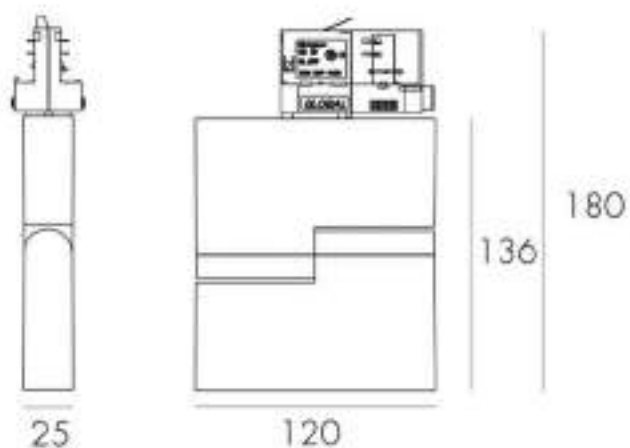

CREE OSRAM

Product Information	Input voltage	DC48V
	Power	12W
	Efficiency	60lm / W
	CRI	>80 >90
	Beam angle	15° / 30° / 45°
	CCT	3000K/4000K/5000K
	Available colour	black / white
	Certification	CE / ROHS



Track spot

XTR-M6102i-24W

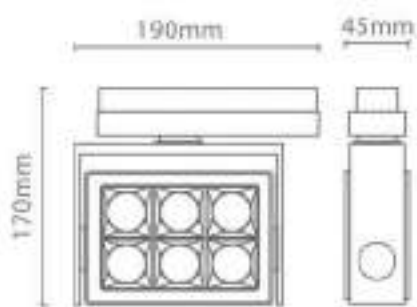

CREE OSRAM

Input voltage	DC48V
Power	24W
Efficiency	70lm / W
CRI	>80 >90
Beam angle	15° / 24° / 38°
CCT	3000K/4000K/5000K
Available colour	black / white
Certification	CE / ROHS



Track spots



XTR-M7108-7W

XTR-M7108-3W(3°)

CREE OSRAM

Product Information	Input voltage	DC48V
	Power	7W / 3W
	Efficiency	70lm / W
	CRI	>80 >90
	Beam angle	3° / 15° / 24° / 38°
	CCT	3000K/4000K/5000K
	Available colour	black
	Certification	CE / ROHS



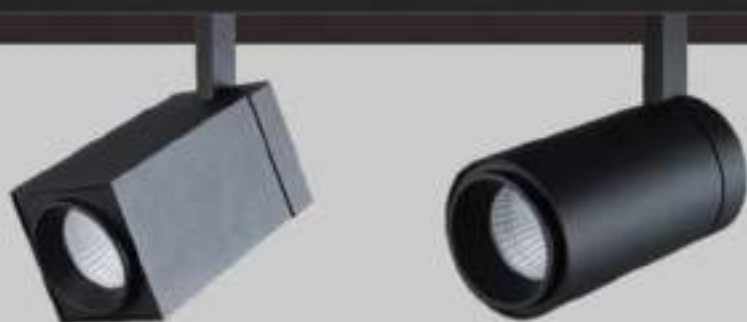

Track spots

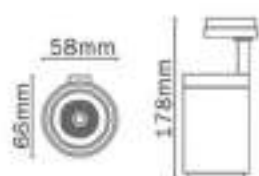

XTR-M6101R-10W

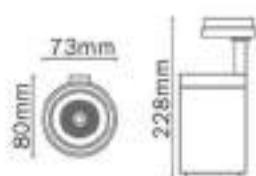

XTR-M6101R-20W

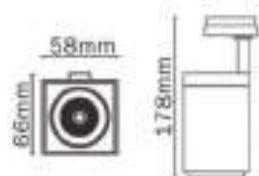

XTR-M6101S-10W

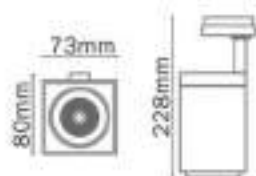

XTR-M6101S-20W



XTR-M6101R



XTR-M6101S



CREE OSRAM

Product Information	Input voltage	DC48V
	Power	10W / 20W
	Efficiency	80lm / W
	CRI	>80 >90
	Beam angle	15° / 24° / 38°
	CCT	3000K/4000K/5000K
	Available colour	black / white
	Certification	CE / ROHS



Track spots

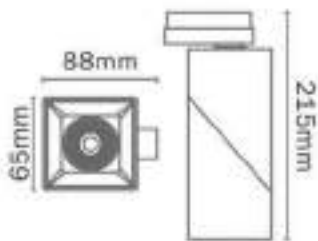

XTR-M30105-20W

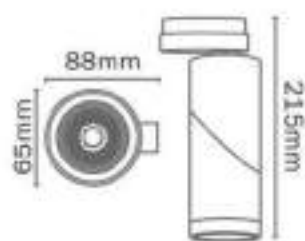

XTR-M3010RA-12W



XTR-M3010RA



XTR-M30105



CREE OSRAM

Product Information	Input voltage	DC48V
	Power	12W
	Efficiency	80lm / W
	CRI	>80 >90
	Beam angle	15° / 24° / 38°
	CCT	3000K/4000K/5000K
	Available colour	black / white
	Certification	CE / ROHS

Pendant light

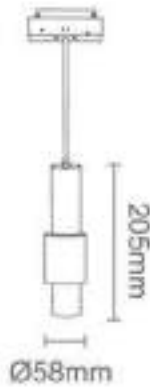

XTR-M7110-7W

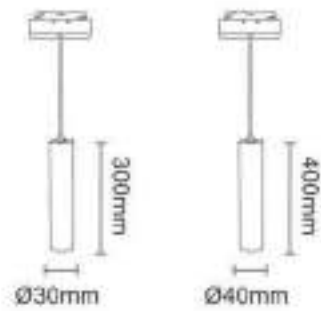

XTR-M7109-5W

XTR-M7109-9W

CREE OSRAM

Product Information	Input voltage	DC48V
	Power	7W
	Efficiency	80lm / W
	CRI	>80 >90
	Beam angle	15° / 24° / 38°
	CCT	3000K/4000K/5000K
	Available colour	black / white
	Certification	CE / ROHS

CREE OSRAM

Product Information	Input voltage	DC48V
	Power	5W / 9W
	Efficiency	80lm / W
	CRI	>80 >90
	Beam angle	15° / 24° / 38°
	CCT	3000K/4000K/5000K
	Available colour	black / white
	Certification	CE / ROHS



CREE OSRAM

Product Information	Input voltage	DC48V
	Power	10W / 20W / 30W
	Efficiency	70lm / W
	CRI	>80 >90
	Beam angle	15° / 30° / 45°
	CCT	3000K/4000K/5000K
	Available colour	black / white
	Certification	CE / ROHS

XTR-M7102-10W

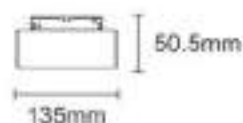

XTR-M7102-20W

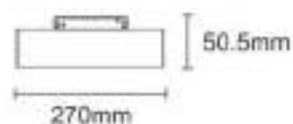

XTR-M7102-30W

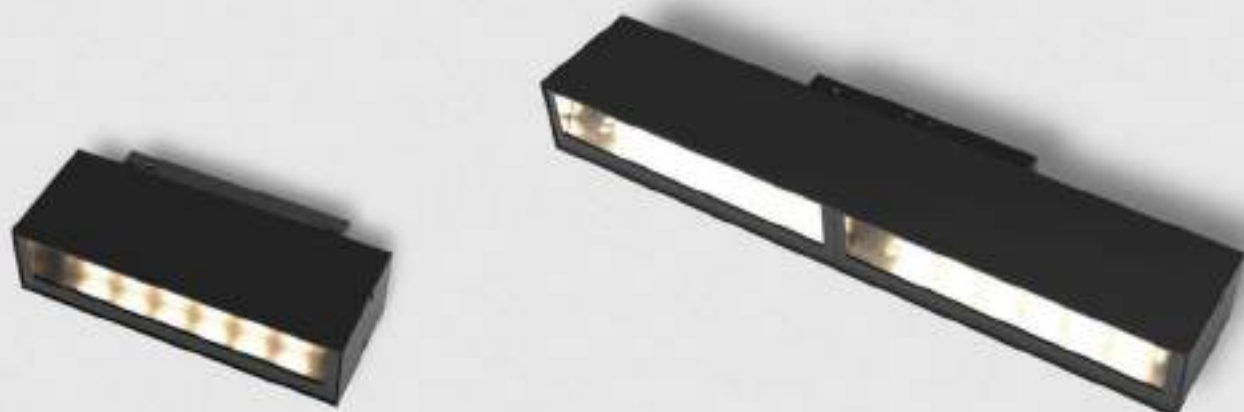

CREE OSRAM

Product Information	Input voltage	DC48V
	Power	10W / 20W / 30W
	Efficiency	70lm / W
	CRI	>80 >90
	Beam angle	WALL WASHER 90°
	CCT	3000K/4000K/5000K
	Available colour	black / white
	Certification	CE / ROHS

XTR-M7103-10W

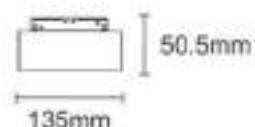

XTR-M7103-20W

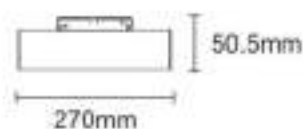

XTR-M7103-30W

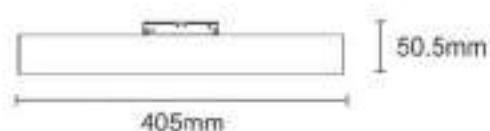

COB Linear



XTR-M8102-6W



XTR-M8102-12W



► For Small Track

CREE OSRAM

Input voltage	DC48V
Power	6W / 12W
Efficiency	80lm / W
CRI	>80 >90
Beam angle	15°/24°/36°
CCT	3000K/4000K/5000K
Available colour	black / white
Certification	CE / ROHS

Product Information

Diffuser Linear



CREE OSRAM

Input voltage	DC48V
Power	8W / 16W
Efficiency	80lm / W
CRI	>80 >90
Beam angle	120°
CCT	3000K/4000K/5000K
Available colour	black / white
Certification	CE / ROHS

Product Information

XTR-M8101-8W



XTR-M8101-16W



Diffuser 90°



CREE OSRAM

Product Information

Input voltage	DC48V
Power	24W
Efficiency	80lm / W
CRI	>80 >90
Lens	120°
CCT	3000K/4000K/5000K
Available colour	black / white
Certification	CE / ROHS

XTR-M7106-24W

24W
diffuser-90°

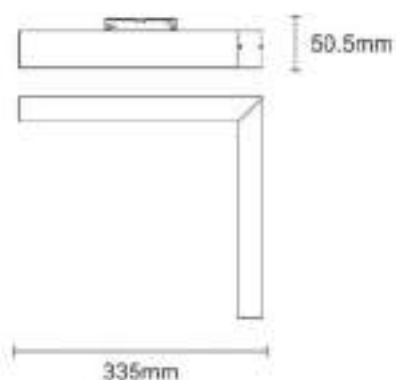

Diffuser

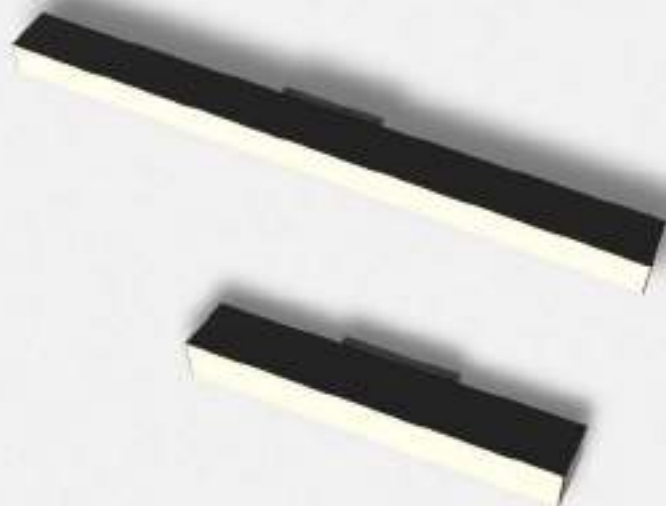

CREE OSRAM

Product Information

Input voltage	DC48V
Power	12W / 24W / 48W
Efficiency	80lm / W
CRI	>80 >90
Beam angle	120°
CCT	3000K/4000K/5000K
Available colour	black / white
Certification	CE / ROHS

XTR-M7101-12W

XTR-M7101-24W

XTR-M7101-48W

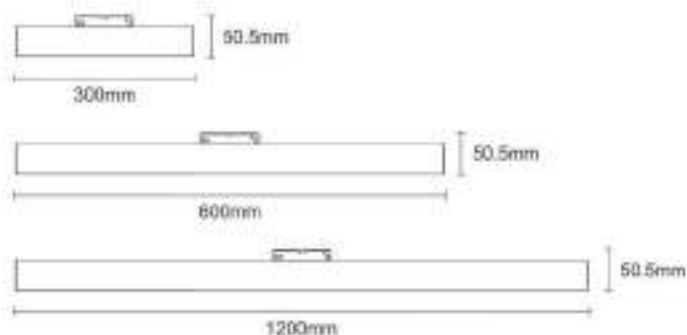



CREE OSRAM

Input voltage	DC48V
Power	10W
Efficiency	80lm / W
CRI	>80 >90
Beam angle	15° / 24° / 36°
CCT	3000K/4000K/5000K
Available colour	black / white
Certification	CE / ROHS

Product Information

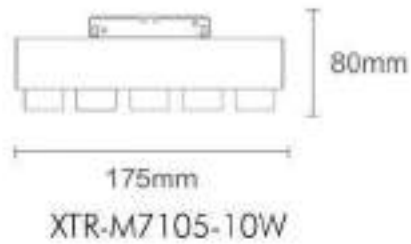

CREE OSRAM

Product Information

Input voltage	DC48V
Power	8W
Efficiency	80lm / W
CRI	>80 >90
Beam angle	10° / 20° / 30°
CCT	3000K/4000K/5000K
Available colour	black / white
Certification	CE / ROHS

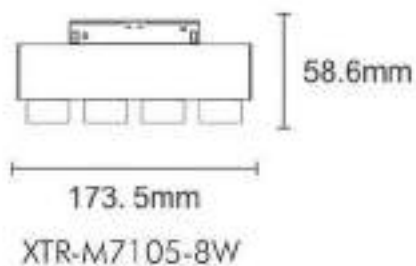

Trazor



The new range of ANKUR Lighting, energy efficient track spots provides a stylish, flexible and versatile LED lighting option for numerous applications in both domestic and commercial use. It is designed with high transmittance glass to enable maximum utilization of light output. The model has the ability to rotate 360 degrees horizontally and 180 degrees vertically, while the 10W rotates 350 degrees horizontally and 35 degrees vertically.



360°

180°

FULLY ADJUSTABLE

rotates 360° horizontally and 180° vertically





ankur
LIGHTING
As BD 8801-2888 Certified Company



CREE LEDS

provides excellent colour rendering
to increase the colour fidelity of the
illuminated object

illuminated object
to increase the colour fidelity of the
illuminated object







Die cast aluminum heat sink is good at heat dissipation, stay low surface temp.& long lifespan. This light is used for project light of shop, clothing spotlight, cabinet light, indoor ceiling, gallery, living room, showrooms, cupboard, museums, lobbies, shopping mall, exhibition, jewelry display, it makes what you are showing more nice-looking.





ANKUR XTR LED 3984 30W 3000K



Wattage: 30W
 CCT: 3000K / 4000K / 6500K
 Material: aluminum
 Rotates: 360°
 Spot headadjust: 180°

Lamp: 1x COB
 Reflector angle: 14°/24°/36°/60°
 Size: Ø: 83mm H: 86mm
 Driver Dimensions H: 130mm
 W: 60mm
 L: 43mm



Available color:



Trazor track spot LED 20W/30W/40W



LED 20W 3000K 14°

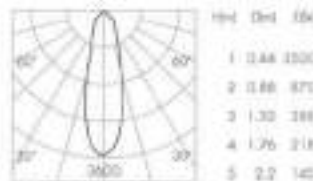

LED 20W 3000K 24°

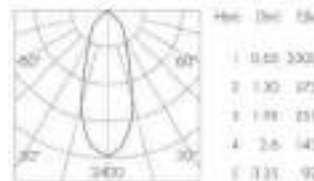

LED 20W 3000K 36°

Pencil Roxx



This small cool track light is extremely fashionable and highly adjustable. It is designed to fit your modern needs and complement any existing decor you have. The brilliant quality material gives the design maximum resilience towards any deterioration caused by heat, humidity, etc. The light checks all safety boxes and will give a cool stylish look for any occasion and style. The model is highly adaptable and looks great in any space.

Aluminum Lamp Body

Adjustable Angle

COB Chip





14°/24°/36°
Different beam angle for choice



Modern Aluminum
LED track light



High quality COB LED chip

Available in 2 sizes



Small
&
Magnificent





Available Collar Shades





ANKUR XTR - LED - IP/3971A 6W

Material: Aluminium
 Rotates: 355°
 Spot head adjust: 90°

Lamp: COB 6W
 3000K / 4000K / 6500K
 CRI 80/90
 Reflector angle: 14°/24°/36°/60°
 AC220V - 50 / 60Hz
 Size: Ø30mm H: 125mm
 Available colours:

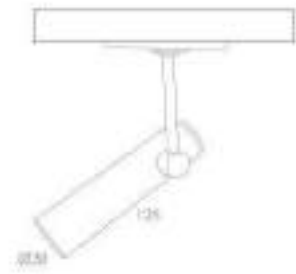

ANKUR XTR - LED - IP/3971B 6W

Material: Aluminium
 Rotates: 355°
 Spot head adjust: 90°

Lamp: COB 6W
 3000K / 4000K / 6500K
 CRI 80/90
 Reflector angle: 14°/24°/36°/60°
 AC220V - 50 / 60Hz
 Size: Ø40mm H: 125mm
 Available colours:

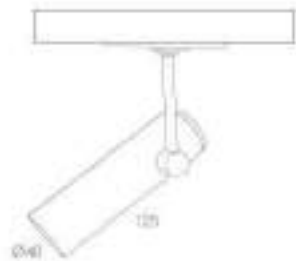

* **NOTE:** Track spots has 2 ways of installation one is track mounted and another is base mounted.

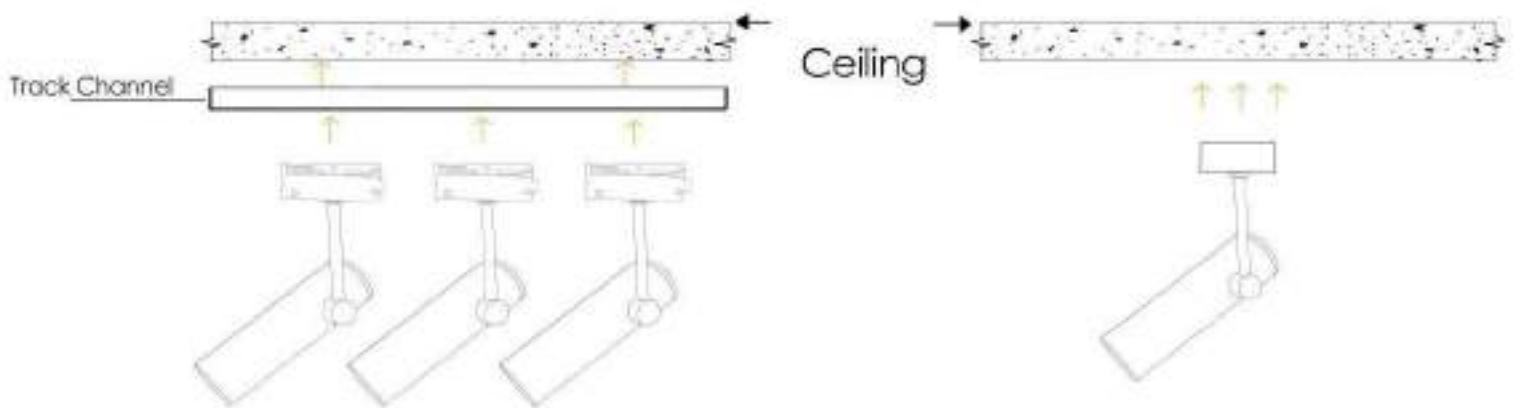

Track Mounted

Base Mounted

ROXX



CRI > 90



The Roxx track spotlight is made highly adjustable to provide you with efficiency in your lighting set-ups. The slender and simple design manages intense illumination making it perfect for any occasion. With its comfortable adaptable capacities, you will get a brilliant illumination for any spaces or subjects according to your needs. The light is easy to use and performs impressively when it comes to durability. This track spotlight will make sure you get the best results for any required project.



Available Body finishes





The specially designed heat sink and airflow system reduces the lamp and surface temperatures with no light spill.

Available Colour Temperature





Roxx With Different Body Finishes

Available in 3 sizes





Base Mounted Track Spots





ANKUR XSL - LED - 3929 6W-8W/ 12W-15W

Material: Aluminium
 Rotates: 355°
 Spot head adjust: 90°

Lamp: COB 1 X 6W-8W/ 12W-15W
 3000K/ 4000K/ 6500K
 CRI 80/90

Reflector angle: 14°/24°/36°/60°
 AC220V - 50/ 60Hz
 Size: Ø55mm H: 145mm
 Available colours:



ANKUR XTR - LED - 3929 18W-20W

Material: Aluminium
 Rotates: 355°
 Spot head adjust: 90°

Lamp: COB 1 X 18W-20W
 3000K/ 4000K/ 6500K
 CRI 80/90

Reflector angle: 14°/24°/36°/60°
 AC220V - 50/ 60Hz
 Size: Ø 75mm H: 160mm
 Available colours:

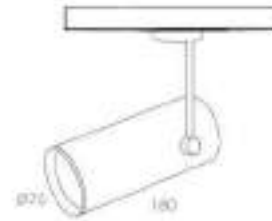

ANKUR XTR - LED - IP/3939 30W

Material: Aluminium
 Rotates: 355°
 Spot head adjust: 90°

Lamp: COB 1 X 30W
 3000K/ 4000K/ 6500K
 CRI 80/90

Reflector angle: 14°/24°/36°/60°
 AC220V - 50/ 60Hz
 Size: Ø75mm H: 220mm
 Available colours:

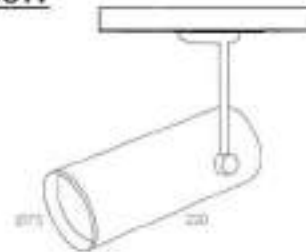

* **NOTE:** Track spots has 2 ways of installation one is track mounted and another is base mounted.

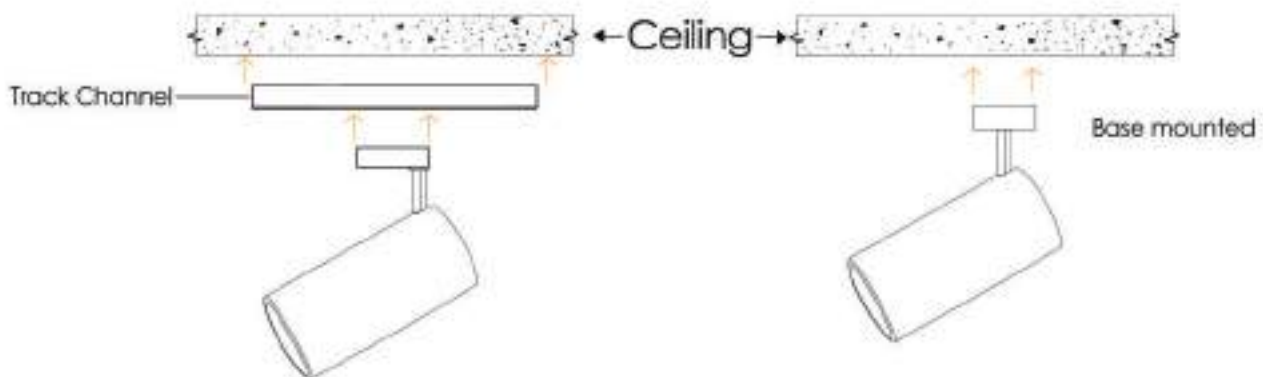

Lexx



The new line of modern-styled track lighting solutions delivers a controlled, powerful, and clean beam of light on high-end retail, gallery exhibits, from just about any mounting height without a visible heat sink or venting as part of its fire retardant modest high grade aluminium casing with energy efficient electronic driver with 2.5 Kva surge protection.



ankur
LIGHTING
AN ISO 9001:2008 CERTIFIED COMPANY



CRI > 90

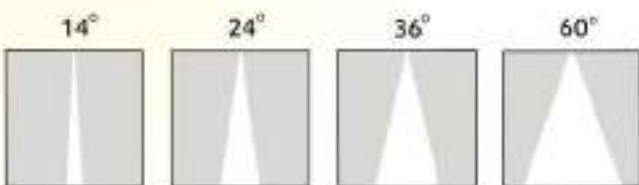



Lexx 60

DIA. - 55mm
Height - 145mm



Lexx 75

DIA. - 75mm
Height - 180mm



Available colour

Lexx 90

DIA. - 90mm
Height - 180mm



GOLDEN
FINISH



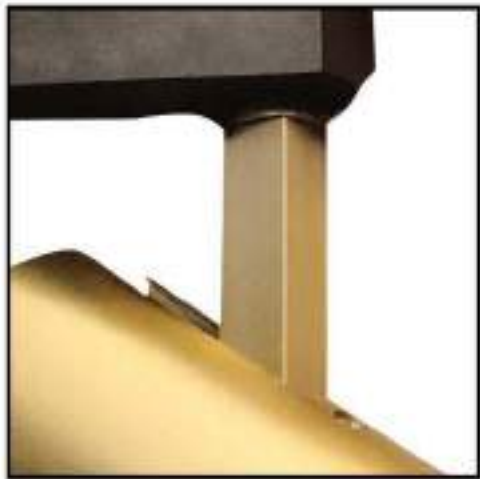



ROSE GOLD **FINISH**

Rose Gold Track lights are brilliant to add a dimension and with the right choice, they add a certain pop of colour which can make a space highly modern and extremely stylish.

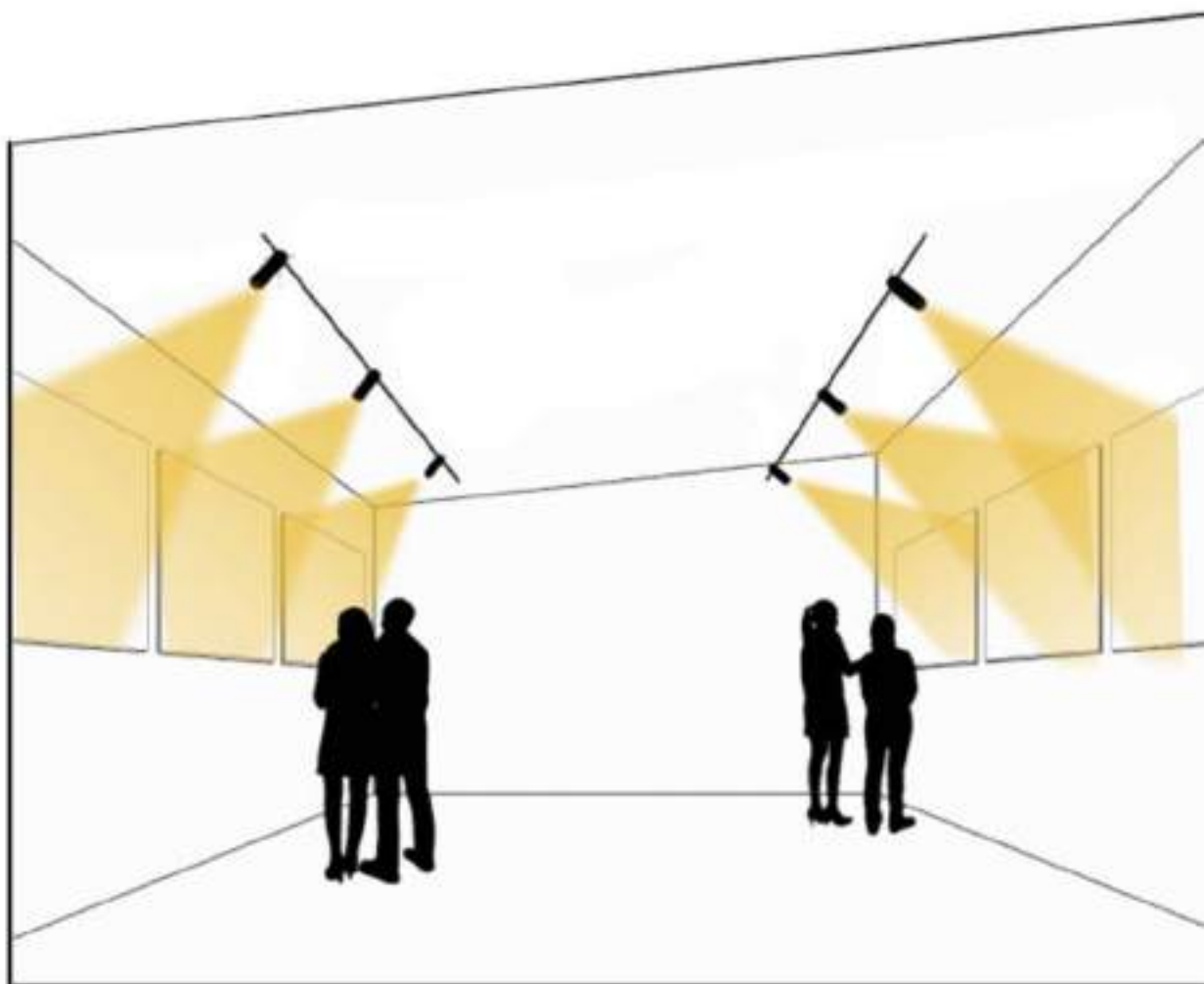



STAINLESS
STEEL
FINISH





355°



90°

Controlling glare at sight, so as to make eyes feels comfortable and create pure light.





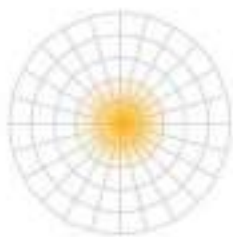

14°

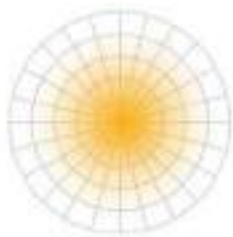

36°

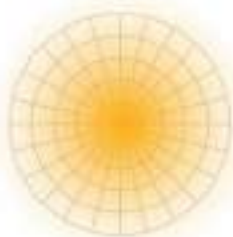

60°





ANKUR XTR-LED IP/9273 10W/15W

Material: Aluminium
 Rotates: 355°
 Spot head adjust: 90°

Lamp: COB 1 X 10W/15W
 3000K/ 4000K/ 6500K
 CRI 80/90
 Reflector angle: 14°/24°/36°/60°
 AC220V - 50/ 60Hz
 Size: Ø55mm H: 145mm

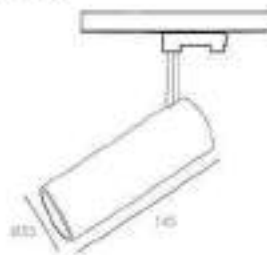

ANKUR XTR-LED 3954 20W/30W

Material: Aluminium
 Rotates: 355°
 Spot head adjust: 90°

Lamp: COB 1 X 20W/30W
 3000K/ 4000K/ 6500K
 CRI 80/90
 Reflector angle: 14°/24°/36°/60°
 AC220V - 50/ 60Hz
 Size: Ø 75mm H: 180mm

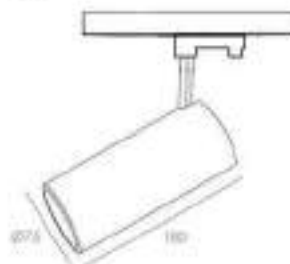

ANKUR XTR-LED 3955 30W/40W

Material: Aluminium
 Rotates: 355°
 Spot head adjust: 90°

Lamp: COB 1 X 30W/40W
 3000K/ 4000K/ 6500K
 CRI 80/90
 Reflector angle: 14°/24°/36°/60°
 AC220V - 50/ 60Hz
 Size: Ø90mm H: 180



* **NOTE:** Track spots has 2 ways of installation one is track mounted and another is base mounted.

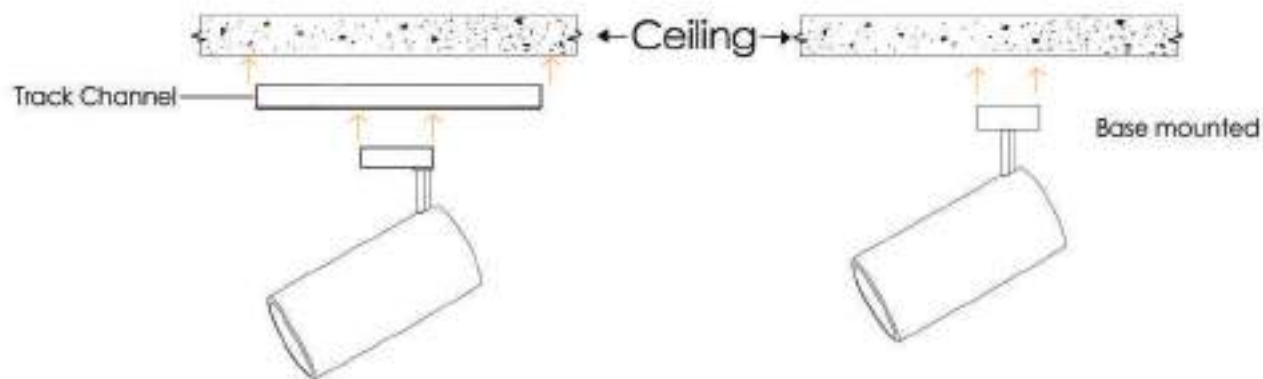

TRACK

S P O T

3987



The new line of modern-styled track lighting solutions delivers a controlled, powerful, and clean beam of light on high-end retail, gallery exhibits, from just about any mounting height without a visible heat sink or venting as part of its fire retardant modest high grade aluminium casing with energy efficient electronic driver with 2.5 Kva surge protection.



355°



90°



ANKUR XTR - LED - 3987

ANKUR XTR - LED - 3987 is a highly adjustable LED track spotlight. Made from aluminium and available in black or white finishes. Adjustable on both X and Y axis for optimal direction of light source. Ideal for commercial applications with bulk quantities available.

Track Spots

with 4 different sizes



Base Mounted Track Spots

with 4 different sizes





- Strong Output
- Forms Wider Beam Angles
- Honeycomb louvers can be use.

- Perfect UGR
- Small in size but gives optimum light
- Honeycomb louvers can be use.





ANKUR XTR - LED - 3987A

Wattage: 12W
Material: Aluminium
Optics: Clear Glass
CRI: 80/90
Colour Temperature: 2700K/3000K/ 4000K/ 6500K
Lumens Per Watt: 95lm/105lm/110lm/115lm
Reflector angle: 14°/ 24°/ 36°/ 60°
Diameter : 60mm
Height : 145mm



Available Colours:



ANKUR XTR - LED - 3987

Wattage: 30W
Material: Aluminium
Optics: Clear Glass
CRI: 80/90
Colour Temperature: 2700K/3000K/ 4000K/ 6500K
Lumens Per Watt: 95lm/105lm/110lm/115lm
Reflector angle: 14°/ 24°/ 36°/ 60°
Diameter : 75mm
Height : 145mm



Available Colours:



ANKUR XTR - LED - 3988W

Wattage: 40W
Material: Aluminium
Optics: Clear Glass
CRI: 80/90
Colour Temperature: 2700K/3000K/ 4000K/ 6500K
Lumens Per Watt: 95lm/105lm/110lm/115lm
Reflector angle: 14°/ 24°/ 36°/ 60°
Diameter : 90mm
Height : 145mm



Available Colours:



ANKUR XTR - LED - 3993W

Wattage: 40W
Material: Aluminium
Optics: Clear Glass
CRI: 80/90
Colour Temperature: 2700K/3000K/ 4000K/ 6500K
Lumens Per Watt: 95lm/105lm/110lm/115lm
Reflector angle: 14°/ 24°/ 36°/ 60°
Diameter : 100mm
Height : 145mm



Available Colours:



ACS



Track and Ceiling Mounted

Two different ways of installation, one is track mounted and other is ceiling mounted and have high brightness COB. Can rotate in all directions, and have 4 Accent to Ambient degree angles to select reflectors (14°, 24°, 36°, 60°).

Widely used in luxury shops, museums and all the spaces where products need to be highlighted.

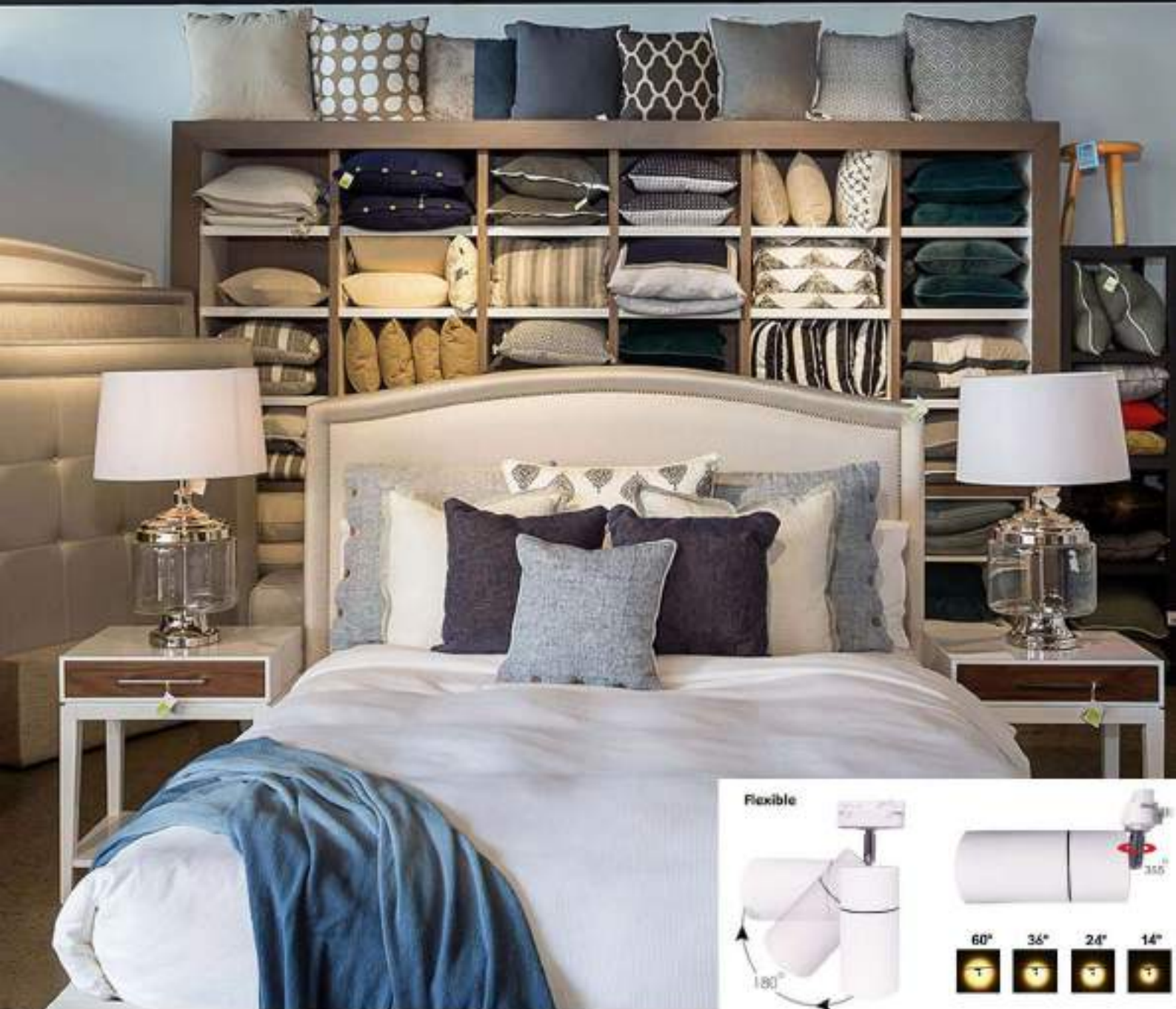

Flexible & adjustable lamp fixtures, have two different installation ways, either put on track or put on ceiling. High precision design, effectively prevents glare, better fit into the decoration. Widely used in Home, Hotels, shops etc.

Accessories:

Honeycomb louver

Available for most luminaires in the range, these louvers enhance visual comfort by controlling unwanted light spill.

Softening lens

Designed to create a smoother, softer beam edge, these lenses are available for most luminaires in the range.

Baffle

Available for the multi series, a baffle can be used to reduce the field angle and control unwanted glare.



An **ANTI-GLARE** luminaire design is proposed to reduce the effect of glare and multi shadow.



The micro-silver **REFLECTOR** providing high LOR UP TO 93%.



ANKUR XTR - LED - 3983 20W/25W/30W

Material: Pure aluminium alloy or Die - cast aluminium alloy shell.

Rotates: 360° rotation

Lamp: COB 1x20W / 1x25W / 1x30W
3000K / 4000K / 6000K

CRI 80/90

Reflector angle: 14°, 24°, 36°, 60°

AC:220V ~50/60Hz

Size: \varnothing :75mm
L:245mm



Available color:



ANKUR XTR - LED - 3983 10W/15W/20W

Material: Pure aluminium alloy or Die - cast aluminium alloy shell.

Rotates: 360° rotation

Lamp: COB 1x10W / 1x15W / 1x20W
3000K / 4000K / 6000K

CRI 80/90

Reflector angle: 14°, 24°, 36°, 60°

AC:220V ~50/60Hz

Size: \varnothing :75mm
L:230mm



Available color:

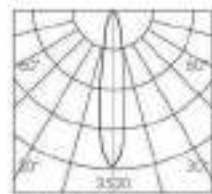

LED 3000K 14°

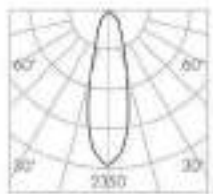

LED 3000K 24°

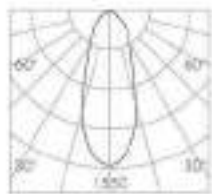

LED 3000K 36°

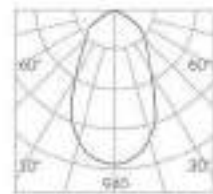

LED 3000K 60°

Beam Angle 14°

Beam Angle 24°

Beam Angle 36°

Beam Angle 60°

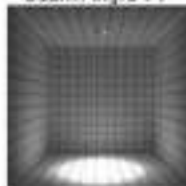

ANKUR XSL - LED - 3983 20W/25W/30W



Material: Pure aluminium alloy or Die - cast aluminium alloy shell,
Rotates: 360° rotation
Lamp: COB 1x20W / 1X25W / 1X30W
3000K / 4000K / 6000K
CRI 80/90
Reflector angle: 14°, 24°, 36°, 60°
AC220V -50/60Hz
Size: \varnothing :75mm
L:245mm



Available color:



ANKUR XSL - LED - 3983 10W/15W/20W



Material: Pure aluminium alloy or Die - cast aluminium alloy shell
Rotates: 360° rotation
Lamp: COB 1x10W / 1X15W / 1X20W
3000K / 4000K / 6000K
CRI 80/90
Reflector angle: 14°, 24°, 36°, 60°
AC220V -50/60Hz
Size: \varnothing :75mm
L:230mm

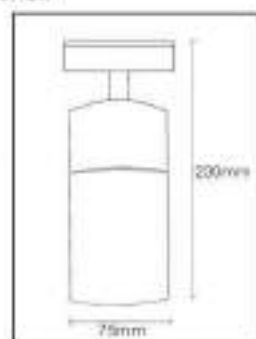

Available color:

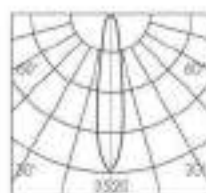

LED 3000K 14°

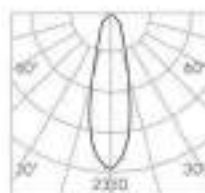

LED 3000K 24°

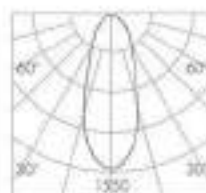

LED 3000K 36°

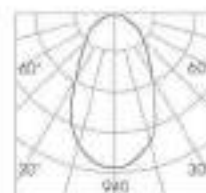

LED 3000K 60°

Beam Angle 14°

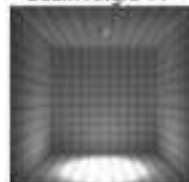

Beam Angle 24°



Beam Angle 36°



Beam Angle 60°

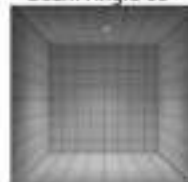



ADJUSTABLE BEAM
ANGLE TRACK LIGHTS

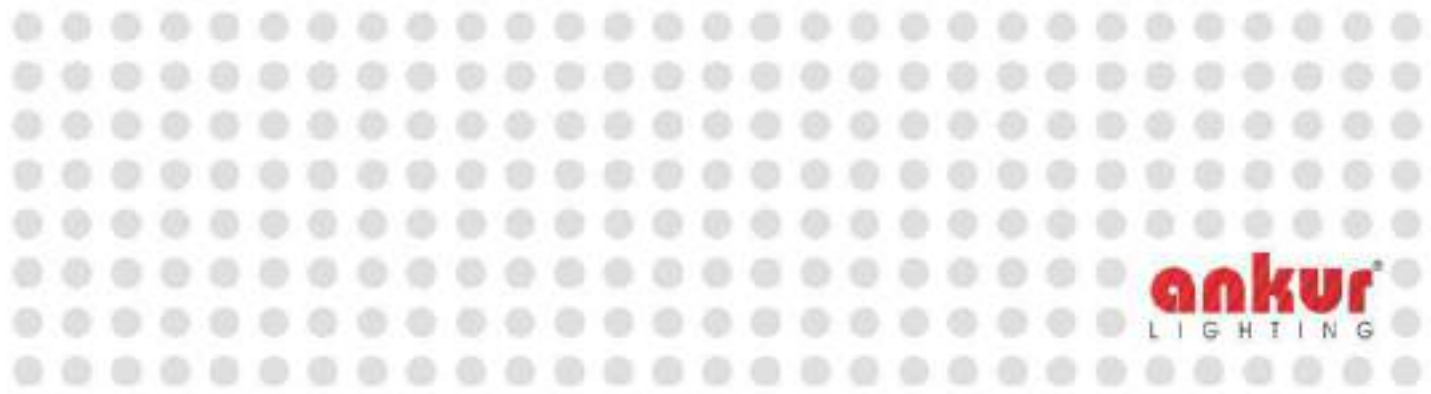



Accessories:

- Adjustable Power and brightness 3-30w
- Adjustable beam angle 10-60 degree
- Optional colortemp 2700-6500K
- Optional Dimmable

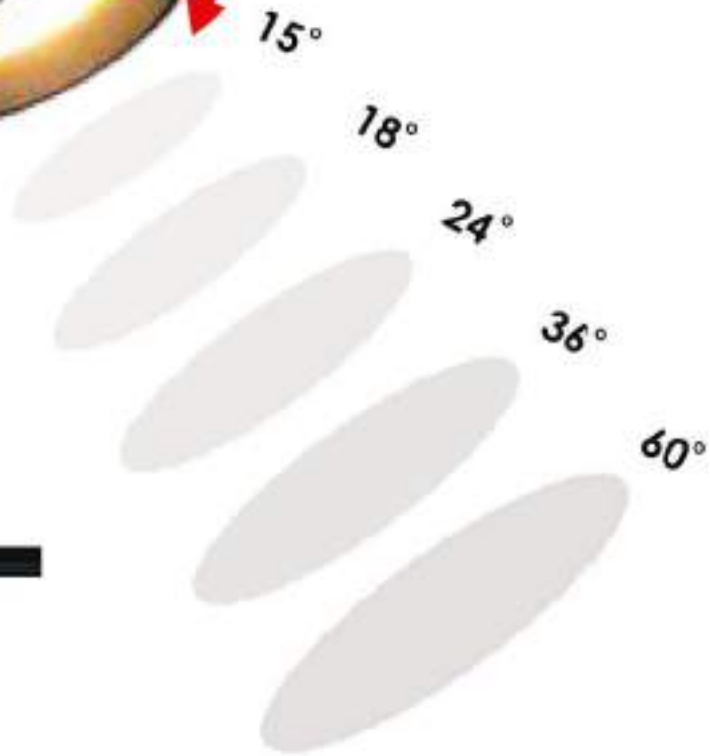

15°-60° Adjust by Hand





BEAM ANGLE



15°

24°

36°

60°





ANKUR XTR LED 339202 - 20w/25w/30w/35w

Power	CCT	CRI	Beam Angle	Lux
20W	3000K	80/90	15°	2100lm
	4000K		24°	2300lm
	6000K		36°	2500lm
25W	3000K	80/90	15°	2625lm
	4000K		24°	2875lm
	6000K		36°	3125lm
30W	3000K	80/90	15°	3150lm
	4000K		24°	3450lm
	6000K		36°	3750lm
35W	3000K	80/90	15°	3675lm
	4000K		24°	4025lm
	6000K		36°	4410lm

20W 3000k 36°

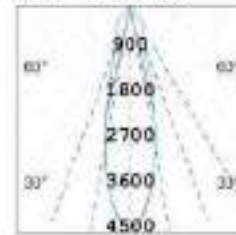

20W 3000k 60°

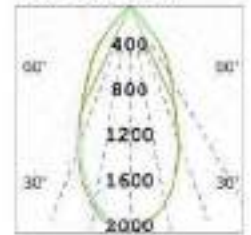

25W 3000k 36°

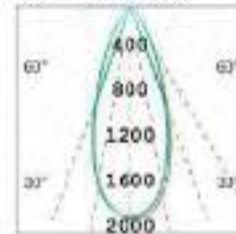

25W 3000k 60°

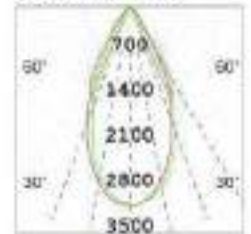

Determining Beam Radius

Using Beam Angle and Fixture Height

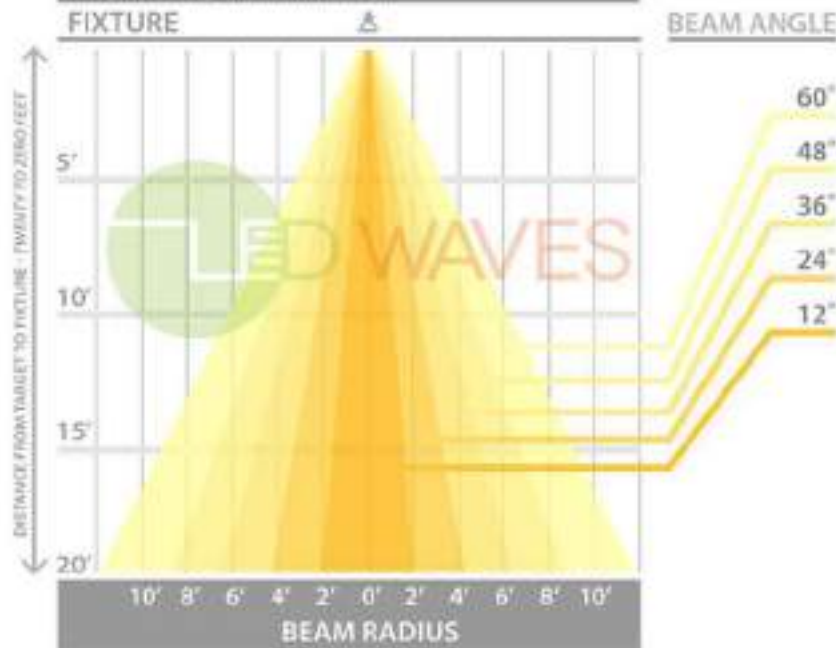

30W 3000k 36°

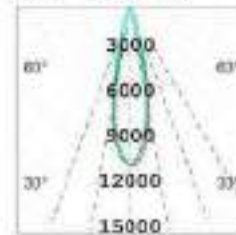

30W 3000k 60°

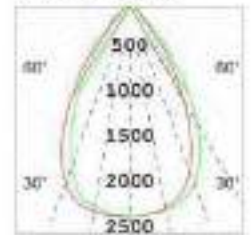

35W 3000k 36°

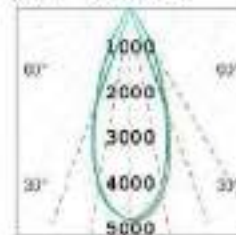

35W 3000k 60°

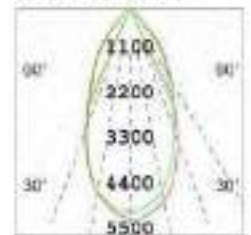



ANKUR XTR EMCA 3946 20W LED CYLINDER

Power	Max 20W
CCT	2700K / 3000K / 4000K / 6000K
CRI	>80 / >90
Input Voltage	AC 220-240V
Beam Angle	15° / 24° / 36°
Finishing Color	White/Black/Silver
Net Weight	0.738kg/pc

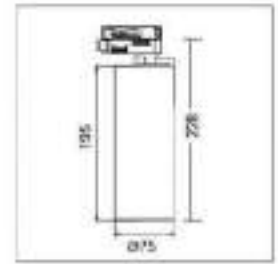

20W 15°				
Lux				
h(m)	d(m)	En	Emax	
1	0.23	7695	19995	
2	0.46	1901	2999	
3	0.66	945	1133	



20W 24°				
Lux				
h(m)	d(m)	En	Emax	
1	0.38	4655	7192	
2	0.76	1168	1798	
3	1.14	518.4	1093	



20W 36°				
Lux				
h(m)	d(m)	En	Emax	
1	0.7	1925	2944	
2	1.4	493.7	755.9	
3	2.1	288.4	327.3	



ANKUR XTR EMCA 3946 30W LED CYLINDER

Power	Max 30W
CCT	2700K / 3000K / 4000K / 6000K
CRI	>80 / >90
Input Voltage	AC 220-240V
Beam Angle	15° / 24° / 36°
Finishing Color	White / Black / Silver
Net Weight	1.016kg/pc

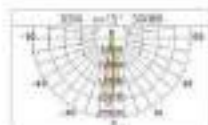
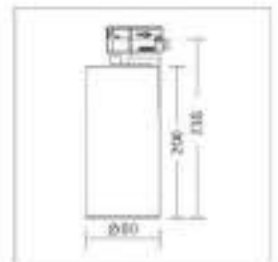

30W 15°				
Lux				
h(m)	d(m)	En	Emax	
1	0.29	9600	21381	
2	0.54	3501	5348	
3	0.68	1554	2375	



30W 24°				
Lux				
h(m)	d(m)	En	Emax	
1	0.39	7157	10236	
2	0.79	1789	2659	
3	1.14	764.2	1137	



30W 36°				
Lux				
h(m)	d(m)	En	Emax	
1	0.67	3375	4881	
2	1.34	853.8	1217	
3	2.01	375	539	



ANKUR XTR-LED 339202 20W

Power	Max 20W
CCT	2700K / 3000K / 4000K / 6000K
CRI	>80 / >90
Input Voltage	AC 220-240V
Beam Angle	15°~80°
Finishing Color	White,Black,Silver
Net Weight	0.811kg/pc

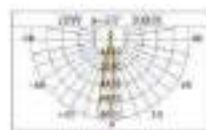
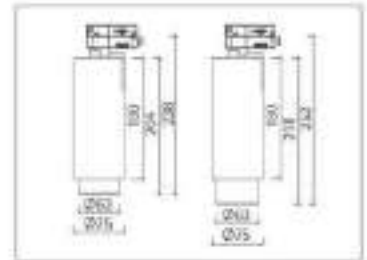

20W 20°				
Dist	Max	Min	Area	Beam
1	0.1	5006	7604	
2	0.2	1251	1901	
3	0.3	656.3	884.9	

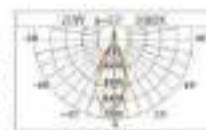

20W 30°				
Dist	Max	Min	Area	Beam
1	0.33	1730	2644	
2	1.04	432.4	660.9	
3	2.18	182.2	283.7	



ANKUR XTR-LED 339203 30W

Power	Max 30W
CCT	2700K / 3000K / 4000K / 6000K
CRI	>80 / >90
Input Voltage	AC 220-240V
Beam Angle	15°~80°
Finishing Color	White,Black,Silver
Net Weight	1.128kg/pc

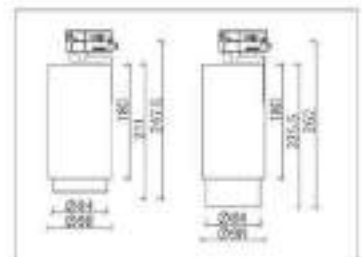

30W 20°				
Dist	Max	Min	Area	Beam
1	0.34	4512	855.3	
2	0.68	1128	419	
3	1.02	601.3	228.7	



30W 30°				
Dist	Max	Min	Area	Beam
1	1.04	1760	2839	
2	2.08	427.3	672.2	
3	3.12	185.9	298.7	

Advantage

Zoomable light distribution with Uniformlight,
improve the utilization rate of light





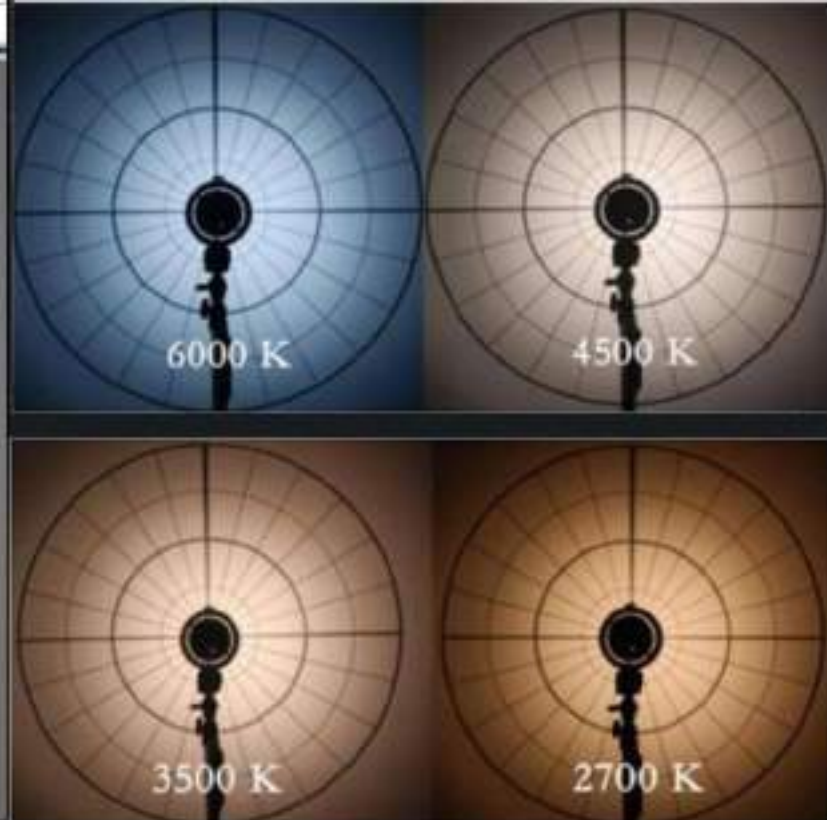

Adjustable Beam Angle
From 20° to 60°.

Beam Angles:

60°

45°

36°

24°



ANKUR XTR - LED - 3985, 25W/30W



Material: Pure aluminium alloy or die - cast aluminium alloy shell.

Rotates: 360° rotation

Lamp: COB 1X25W / 1X30W

3000K / 4000K / 6000K

CRI 80/90

Reflector angle: 20-60°

AC220V ~50/60Hz

Size: ø:100mm

L:130mm



ANKUR XTR LED- 3976, 25W / 30W



Material: Pure aluminium alloy or die - cast aluminium alloy shell.

Rotates: 360° rotation

Lamp: COB 1X25W / 1X30W

3000K / 4000K / 6000K

CRI 80/90

Reflector angle: 16°, 24°, 36°

AC220V ~50/60Hz

Size: ø:85mm

L:135mm

Available color:

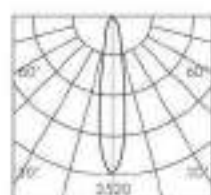
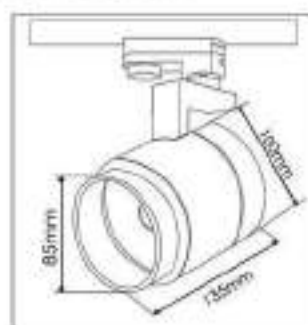

LED 3000K 16°

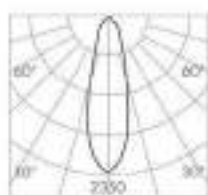

LED 3000K 24°

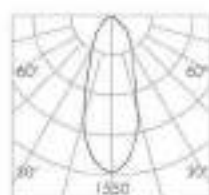

LED 3000K 36°

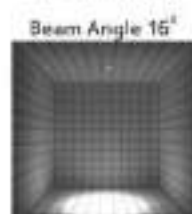

ANKUR XTR - LED - 3976

WITH FLAPS



ANKUR LED-3976 Light with manually adjust flaps to change the direction and area of Light. Suitable for stage, events where needs high brightness environment. Anti-glare flaps for directed light towards the object, minimal scattering losses, blades made from aluminium, frame made from galvanised sheet steel.

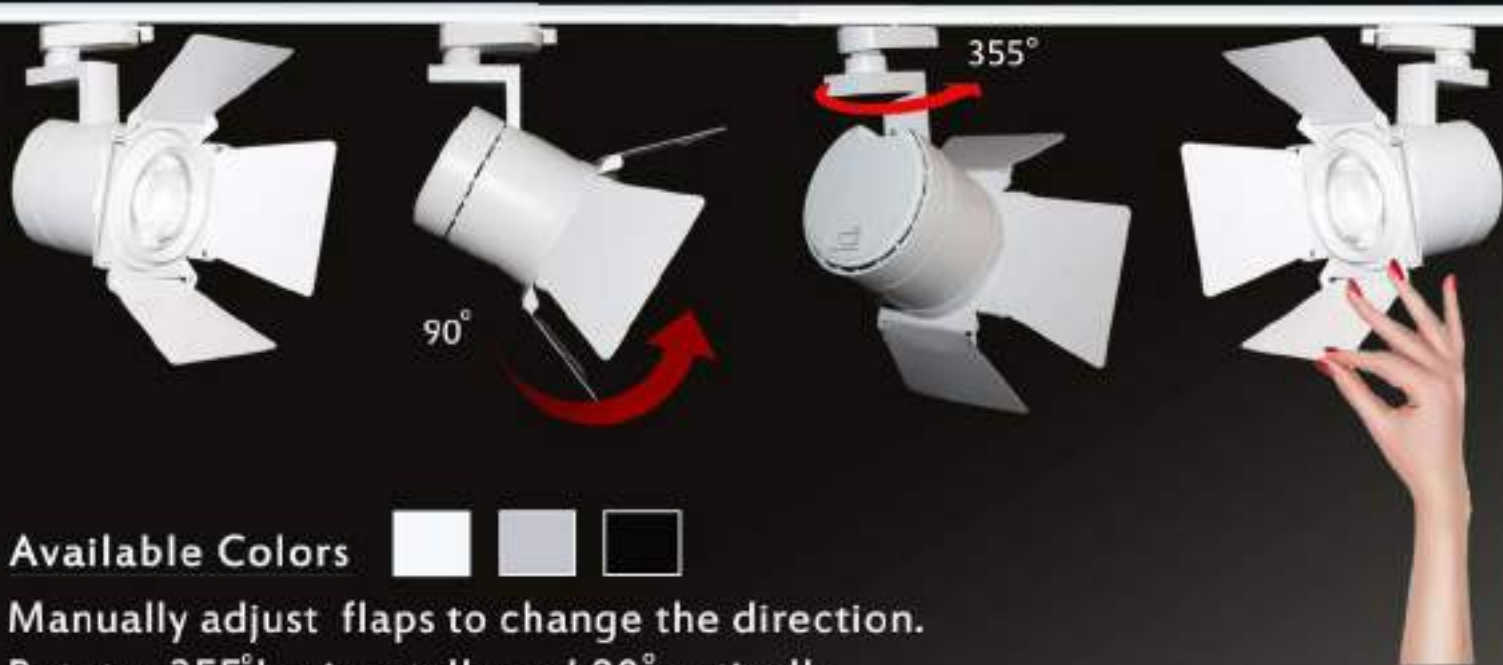

Available Colors

Manually adjust flaps to change the direction.

Rotates 355° horizontally and 90° vertically

L01

FOR ACCESSORY CONNECTION RING

For filter glasses, lens or
honeycomb louver

L03

WITH CROSS LOUVER CONNECTION TUBE

It is possible to
attach additional filter,
lens or honeycomb louver

L02

CONNECTION TUBE

For filter glasses,
lens or honeycomb louver

L04

VISOR

For glare protection and filter glasses,
lens or honeycomb louver

L05

ANTI GLARE FLAPS

It is possible to attach
additional color filter glasses





The LED track light with 4 adjustable leaves on the front. It can focus light depend on needed. It is a perfect lighting solution for like shops, showrooms, public buildings and galleries. An extremely powerful and versatile fixture with outstanding light output and consuming only 25W of power. The LED track light unique segmented reflector in sheet reflector plate, provides superior reflection abilities and up to 90% and can be applied for accent lighting or general lighting.



Honeycomb louver

Available for most luminaires in the range, these louvers enhance visual comfort by controlling unwanted light spill.



Softening lens

Designed to create a smoother, softer beam edge, these lenses are available for most luminaires in the range.



Linear spread lens

The linear spread lens modifies the beam into an oval shape, ideal for grazing or to form a narrow strip of light.



Snoot

Available for the multi series, a snoot can be used to reduce the field angle and control unwanted glare.



Anti-glare flaps

Manually adjust flaps to change the direction.

ANKUR XTR - LED - 3976 WITH FLAPS



Material : Aluminium Die- Cast
 Finish : Pearl White / Grey / Black
 Power Watt : 30W
 Input Voltage : 230V-240V-50Hz
 Light Source : 1x 30W LED
 Lumens Flux : 612 lm
 CCT : 3000K/4000k/6000k
 IP Rating : IP20
 CRI 80/90
 Size: W:95mm
 D:85mm
 H:100mm

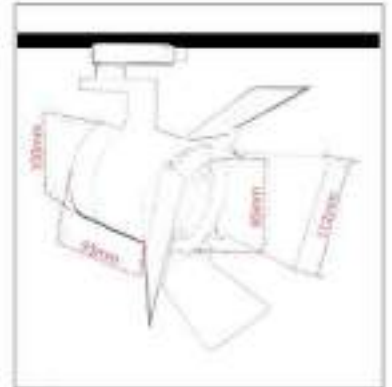

Flap Size:
 Max. width :112mm
 Min. width :72mm
 length :85mm

Available color:

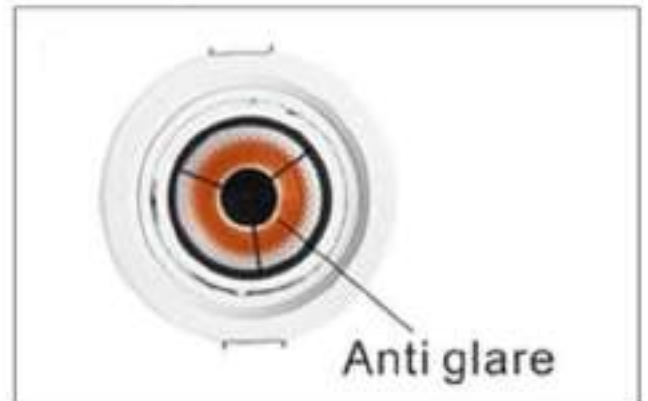

LINUS

TRACK SPOT



Two different ways of installation, one is track mounted and other is ceiling mounted and have high brightness COB. Can rotate in all directions, and have 4 Accent to Ambient degree angles to select reflectors (10°, 20°, 30°,). Widely used in luxury shops, museums and all the spaces where products need to be highlighted.





ankur
LIGHTING
An ISO 9001:2008 Certified Company



CRI > 90

10°



20°



30°



Track Spots

with 3 different sizes
and wattages



WATTAGE: 25W - 30W



WATTAGE: 12W - 18W



WATTAGE: 6W -9W

Track Spots

Base Mounted

with 3 different sizes
and wattages



WATTAGE: 25W - 30W



WATTAGE: 12W - 18W



WATTAGE: 6W - 9W



Multi-Purpose **Track spot**
with anti glare clear lens



Anti-glare

Deep recessed light source,
Reduced glare.

An **ANTI-GLARE** luminaire design is proposed
to reduce the effect of glare and multi shadow.





ANKUR XTR - LED - 3995

Wattage: 6-9W
Material: Die Cast Aluminium Body
Optics: Clear Glass Anti-Glare Lens
CRI: 80/90
Colour Temperature: 3000K/ 4000K/ 6500K
Lumens Per watt: 100lm/ 105lm/ 110lm
Reflector angle: 10°/ 20°/ 30°
Diameter: 60mm
Height : 80mm

Available Colours:



ANKUR XTR - LED - 3994

Wattage: 12-18W
Material: Die Cast Aluminium Body
Optics: Clear Glass Anti-Glare Lens
CRI: 80/90
Colour Temperature: 3000K/ 4000K/ 6500K
Lumens Per watt: 100lm/ 105lm/ 110lm
Reflector angle: 10°/ 20°/ 30°
Diameter: 60mm
Height : 100mm

Available Colours:



ANKUR XTR - LED - 3994

Wattage: 25-30W
Material: Die Cast Aluminium Body
Optics: Clear Glass Anti-Glare Lens
CRI: 80/90
Colour Temperature: 3000K/ 4000K/ 6500K
Lumens Per watt: 100lm/ 105lm/ 110lm
Reflector angle: 10°/ 20°/ 30°
Diameter: 75mm
Height : 135mm

Available Colours:



*SAME SIZES OF TRACK SPOTS ALSO AVAILABLE IN BASE MOUNTED.

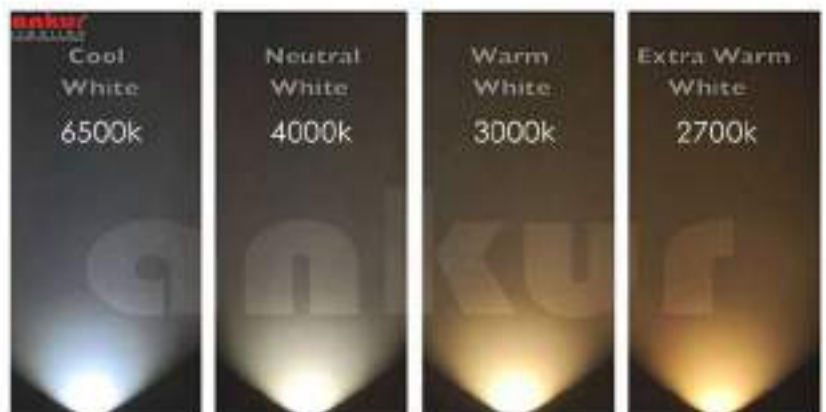





The simplicity of the product makes it can be use anywhere, especially widely used in shops, coffee bar, museum and some artistic tasted space.

The LED-fixtures can be inserted or moved. The led fixtures are simillar in style, each one of them has its own character and lighting quality.





ANKUR XRL/LED- IP/0918

Material: Pressure Die-cast aluminium
 Rotates: 360°
 Spot head adjust: 180°

Lamp: COB 1x25W
 3000K / 4000K / 6000K
 CRI 80/90
 Reflector angle: 120°
 AC220V ~50/60Hz
 Size: ø:120mm
 L:145mm

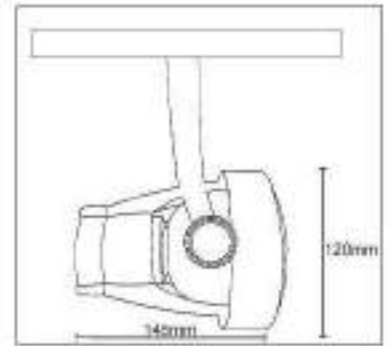

Available color:



ANKUR XRL/LED- IP/0918B

Material: Pressure Die-cast aluminium
 Rotates: 360°
 Spot head adjust: 180°

Lamp: COB 1x20W / 1x30W / 1x40W
 3000K / 4000K / 6000K
 CRI 80/90
 Reflector angle: 10°/24°/38°/60°
 AC220V ~50/60Hz
 Size: ø:120mm
 L:145mm



Available color:



Profile Lights



LED Linear Profile light offers a uniquely clean, simple lighting system, involves uniform lines of light across walls and ceilings. The minimal design offers a total light effect providing outstanding visual comfort with reductions in luminance levels. The numerous installation variants fulfill the needs of the most demanding lighting designers and thus make it the ideal solution for spaces of every shape.



Polycarbonate Diffuser —————

Aluminum Channel —————

LED Strip Light —————

PROFILE LIGHTS

Recessed, suspended or hanging profile lights are a fantastic way to achieve a contemporary and stylish look in any interior space. Use of linear geometry and clean designing adds a simple yet architectural design element to your interiors.



Surface Mounting



Pendant



Recessed



Corner



Floor



Stair

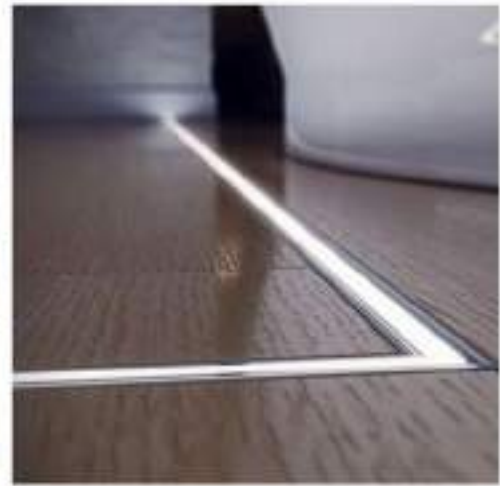

Easy Installation

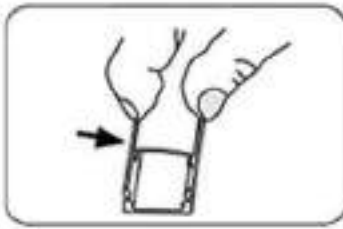

Insert one edge of the cover into one side of the all aluminium channel



Snap and press another edge of cover into the opposite of the channel

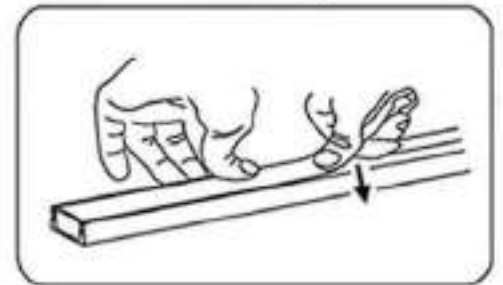

Press the cover along with the channel



All Accessories Included

1Meter/3.3ft

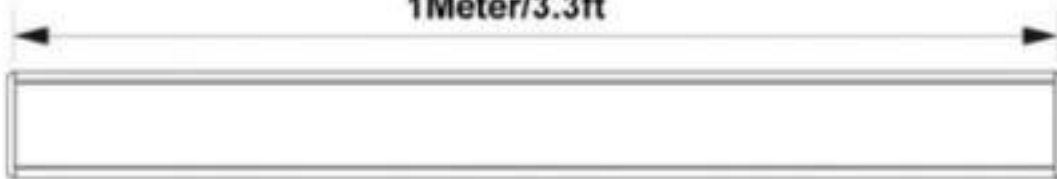

End Cap With Hole



End Cap Without Hole



Metal Mounting Clip



Screw for Hard Wall Or Ceiling



Screw For Woodiness

PROFILE

ANKUR LED - RL - GL - 1712

Width - 17.4mm

Height - 12.1mm

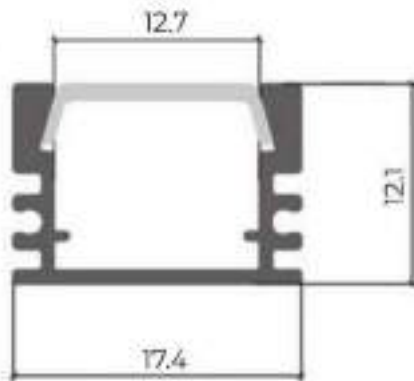

Features

1. More artistic--The frame can be painted into the same color with the wall, which looks more beautiful.
2. Won't see led dot when lighting up.
3. Small size won't take up too much space

Note:

Length can be customized to any.

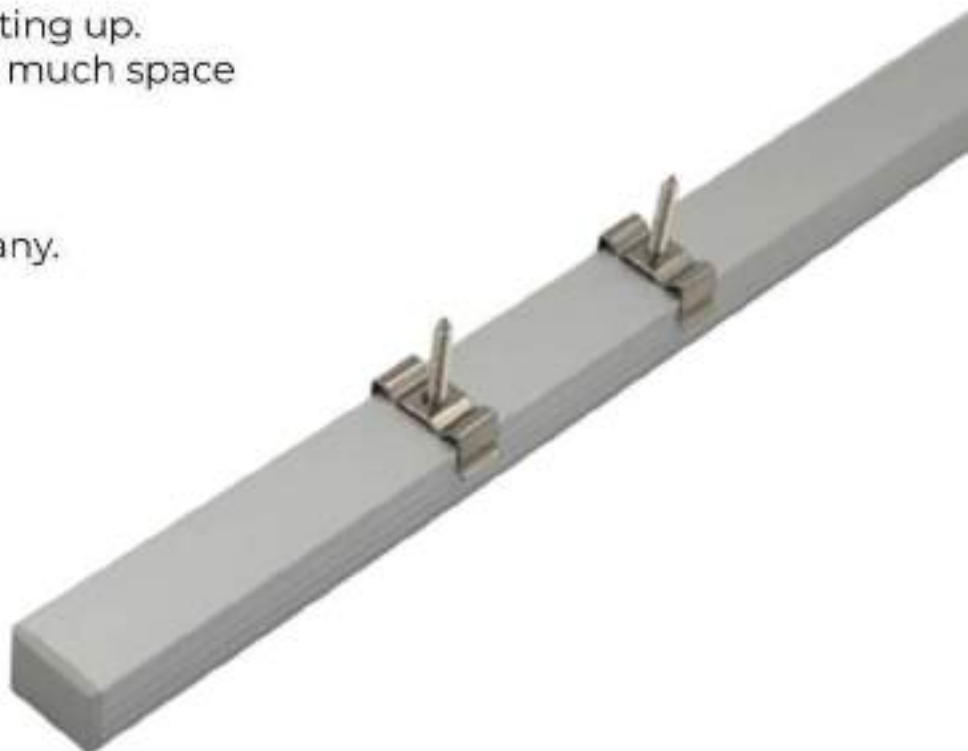



PROFILE

ANKUR LED - RL - GL - 2412

Width - 24.4mm

Height - 12.1mm

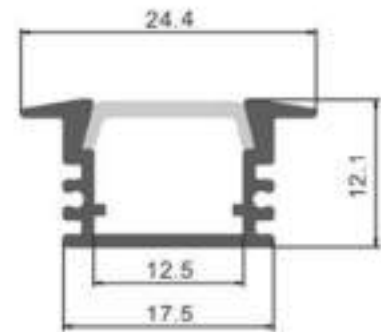

Ankur Lighting brings you the unique straight line style decorative lights known as LED PROFILE. These LED Profile are made of Aluminium and add premium looks to your home, office, banquets, etc. So be ready to transform your premises into a magnificent place with these LED profiles. LED profile needs to be fitted with LED Strips to illuminate and create the desired effect.



end cap x2



clip x2





PROFILE

ANKUR LED - RL - GL - 2320

Width - 23.6mm

Height - 20.4mm

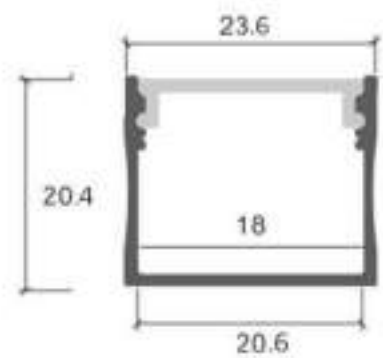



PROFILE

ANKUR LED - RL - GL - 3020

Width -30mm

Height -20.4mm

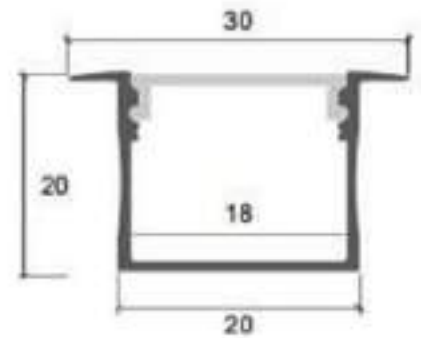

DESCRIPTION

Size:	L X 30 X 20mm
Material:	Aluminium
Surface:	Silver
Cover:	Pc
Apply:	LED Strip Light
Available Length:	0.5 - 2.5m

Installation



recessed



end cap x2







PROFILE

ANKUR LED - LINEAR - 8640

Width -86mm

Height -40mm

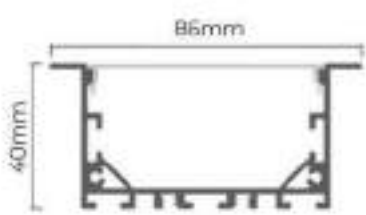

metal end cap



metal clip

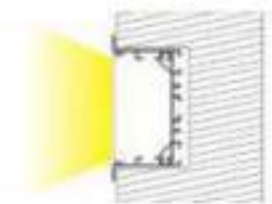

PROFILE

ANKUR LED - LINEAR - 8075

Width - 80mm

Height - 75mm

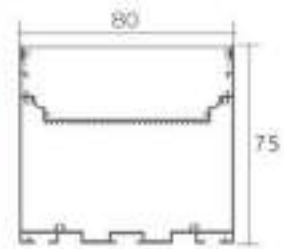

DESCRIPTION

Size:	L X 80 X 75mm
Material:	Aluminium
Surface:	Silver
Cover:	Pc
Apply:	LED Strip Light
Available Length:	0.5 - 2.5m

Installation

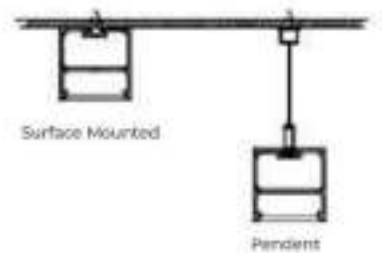

end cap x2



clip x2



wire





PROFILE

ANKUR LED - RL - GL - 9075

Width - 90mm

Height - 75mm

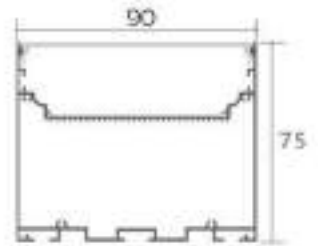

DESCRIPTION

Size:	L X 90 X 75mm
Material:	Aluminium
Surface:	Silver
Cover:	Pc
Apply:	LED Strip Light
Available Length:	0.5 - 2.5m

Installation

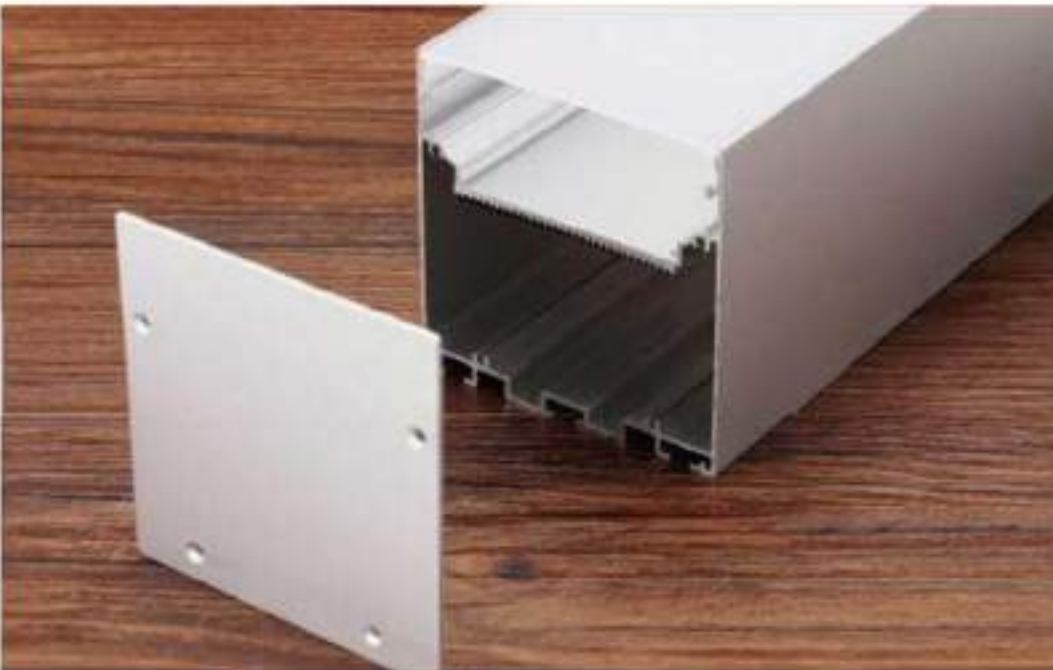
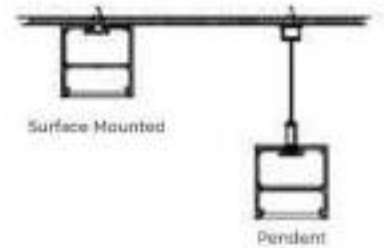

end cap x2



clip x2



wire





PROFILE

ANKUR LED - RL - GL - 1515

Width - 15.7mm

Height - 15.7mm

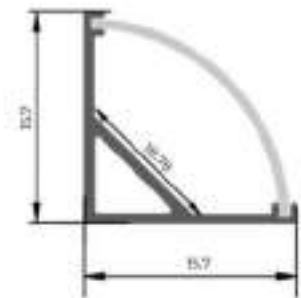

DESCRIPTION

Size:	L X 15.7 X 15.7mm
Material:	Aluminium
Surface:	Silver
Cover:	Pc
Apply:	LED Strip Light
Available Length:	0.5 - 2.5m

Corner Installation

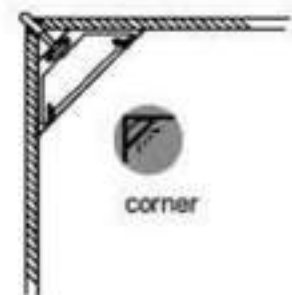

end cap x2



clip x2





PROFILE

ANKUR LED - RL - GL - 146

Width -14.3mm

Height -6.7mm





PROFILE

ANKUR LED - RL - GL - 4535

Width - 80mm

Height - 75mm

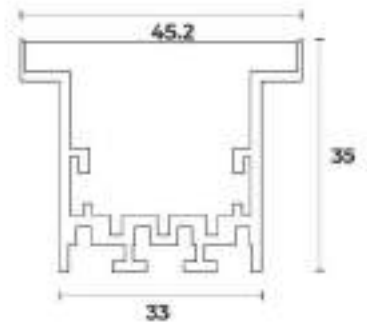





STEP PROFILE LIGHT

ANKUR LED - LSP - T1003

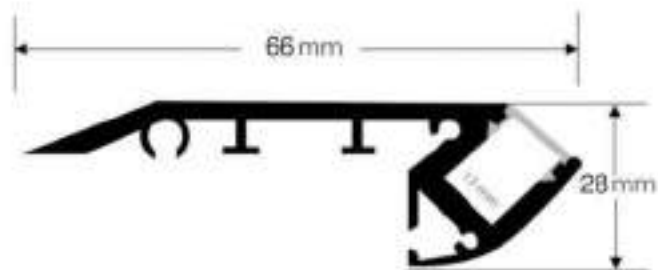

Profile light is the latest solution for lights, easy to install, the offered aluminum fabricates product has been specially designed for decorative lighting of residential and commercial building. Aluminum Profile.the offered product is also used as concealed lighting, cabinet light, Almira light, home theater light, staircase





The Staircase LED profile is designed in such a way that it fits perfectly on staircases. These LED profiles come in various wattage & ingress protection of IP20 available in lengths. Different types of profiles can be combined with LED strip lights to create infinite architectural and interior lighting solutions. It is always good to light up stairs properly as they not only give a modern look to the interiors/ exteriors but also provides safety.



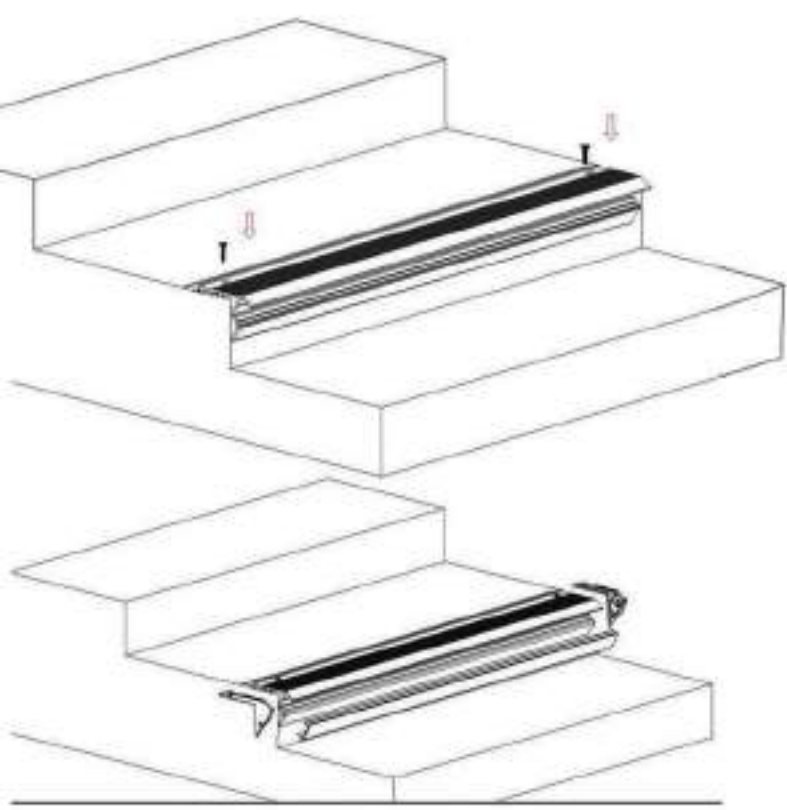

ANKUR LED profile is an aluminium non-slip profile for stairs equipped with a knurled surface and an integrated LED lighting system to be applied after the installation of the covering. Its particular design makes it a much sought after and elegant profile also for modern stairs.



ankur
LIGHTING
An ISO 9001:2005 Certified Company



All New Recessed

Linear Series

For a futuristic look that will complete all your modern interior requirements, our linear light design is a perfect model. The minimalist and chic look will give a modern and elegant vibe that will reflect the best of your personal taste. This chic design is available in three colours which are white, black and grey. You can choose the one that suits your interior design in the best way possible. The magnificent quality makes the product highly durable and makes it very easy to install.



Recessed Schematic diagram



Step1: Installation of main profile + power supply + end cap

Step2: Embedded installation

Step3: Install light source + cover

Step4: Paint

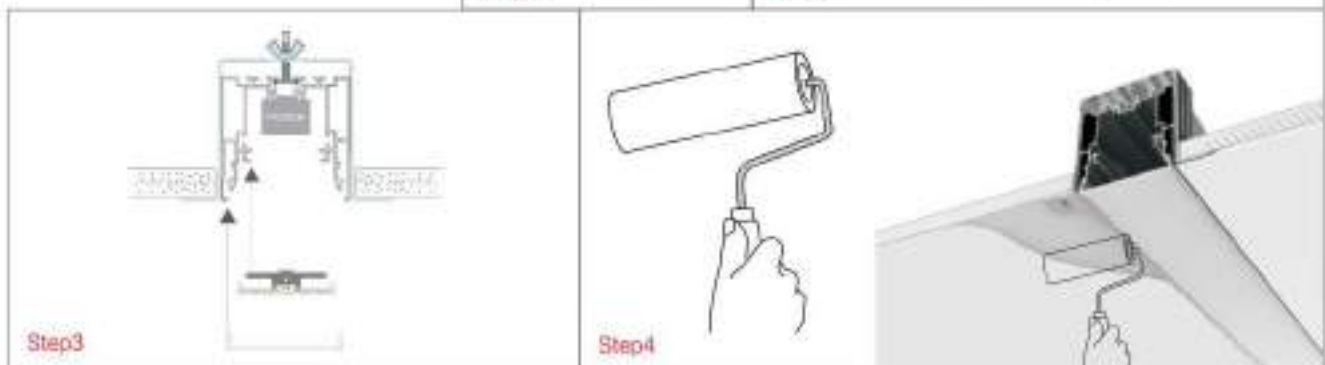
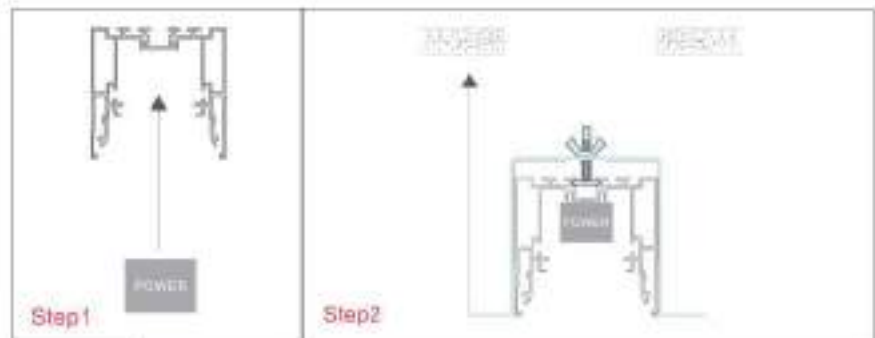



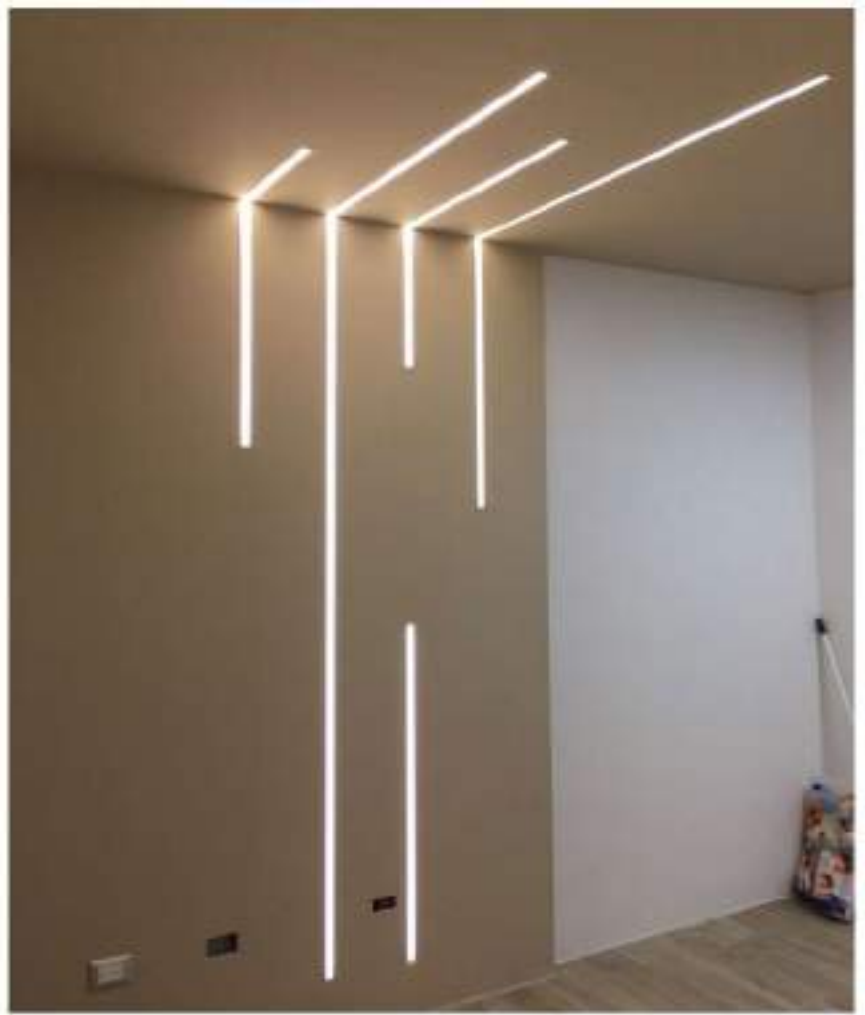







UNIFORMLY DISTRIBUTION OF LIGHT

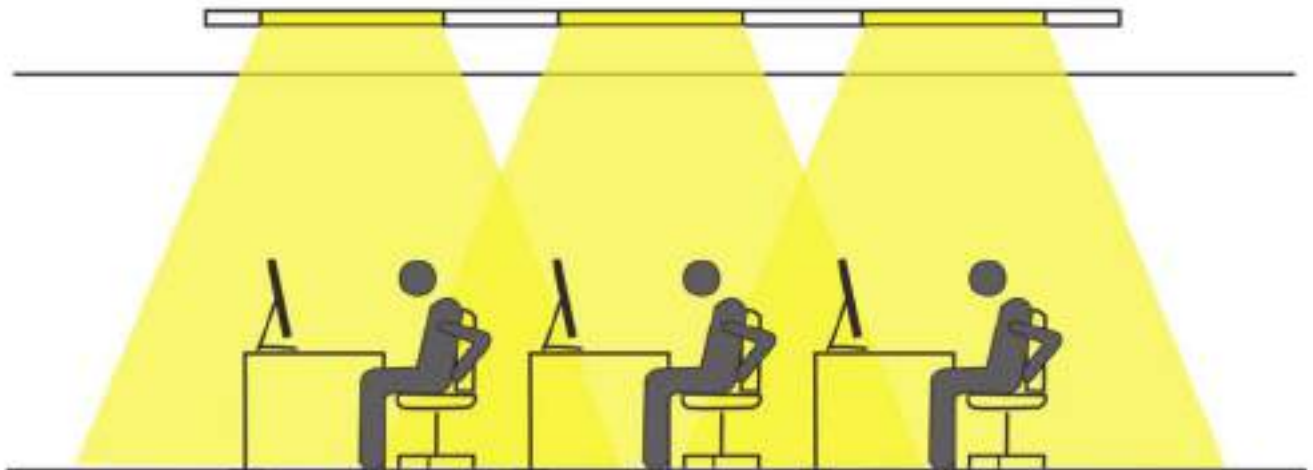

ANKUR LED - RL - GL - 5633 25mm

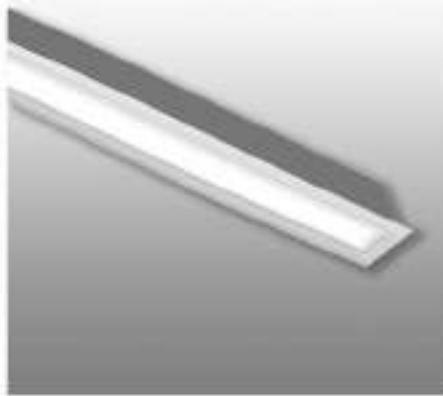

Material : Pure aluminium extrusion and aluminium alloy shell
Strip Material : Steel
Light Source : SMD Strip
Wattage : 10W / 20W / 30W / 40W per meter
CCT: 3000K / 4000K / 6000K
CR : 80 / 90
Electronic Driver : Philips / Fulham / Osram
Beam Angle : 120°
AC240V ~ 50 / 60Hz
Length : 1000mm, Customize Size On Request
W : 25mm
H : 25mm
Available Color:



ANKUR LED - RL - GL - 5641 45mm



Material : Pure aluminium extrusion and aluminium alloy shell
Strip Material : Steel
Light Source : SMD Strip
Wattage : 10W / 20W / 30W / 40W per meter
CCT: 3000K / 4000K / 6000K
CR : 80 / 90
Electronic Driver : Philips / Fulham / Osram
Beam Angle : 120°
AC240V ~ 50 / 60Hz
Length : 1000mm, Customize Size On Request
W : 45mm
H : 35mm
Available Color:



ANKUR LED - RL - GL - 5658 90mm



Material : Pure aluminium extrusion and aluminium alloy shell
Strip Material : Steel
Light Source : SMD Strip
Wattage : 10W / 20W / 30W / 40W per meter
CCT: 3000K / 4000K / 6000K
CR : 80 / 90
Electronic Driver : Philips / Fulham / Osram
Beam Angle : 120°
AC240V ~ 50 / 60Hz
Length : 1000mm, Customize Size On Request
W : 90mm
H : 38mm
Available Color:



High Bay 5913



Ankur SVT LED Highbay Light

Perfect for large areas such as backyards, stadiums, big grounds and more with its powerful and efficient illumination, Ankur's Highbay Light proves to be the pick of the bunch when it comes to lighting up in industrial spaces. This outstanding luminaire has a variable colour temperature ranging from warm (3000K) to cool (6000K) and incorporates premium LED technology to provide the best performance.

Application Area

Widely used areas are, factories, workshops, warehouses, logistics centres, exhibition hall, stadiums, shipyards, mines, highbay toll stations, gas stations, supermarkets, farmers markets and so on.



- IP66
- High brightness
- Energy-saving & maximize output





Features:

- Enjoy the ideal brightness and good heat dissipation with die-cast aluminum and the design in a full shape.
- This 50W-200W watt LED lamp is perfect for warehouses, supermarkets, gyms, retail spaces, manufacturing facilities, etc. It can be used outdoors and indoors.
- The combination of die-cast aluminum housing with high-tech heat sink ensures excellent heat dissipation, protects the LED controller and extends usage time





Stronge Connectivity

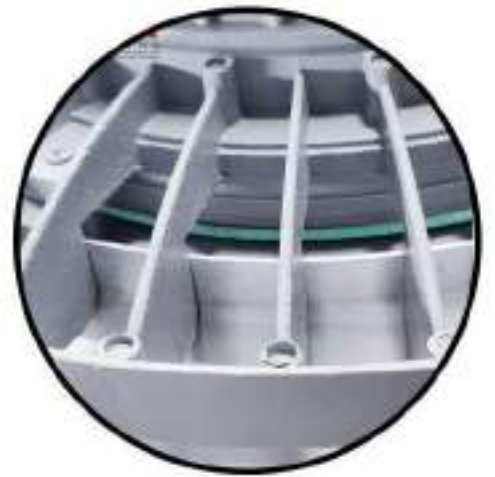

Better Heat Dissipation



High Quality LED Chips



Aluminium body

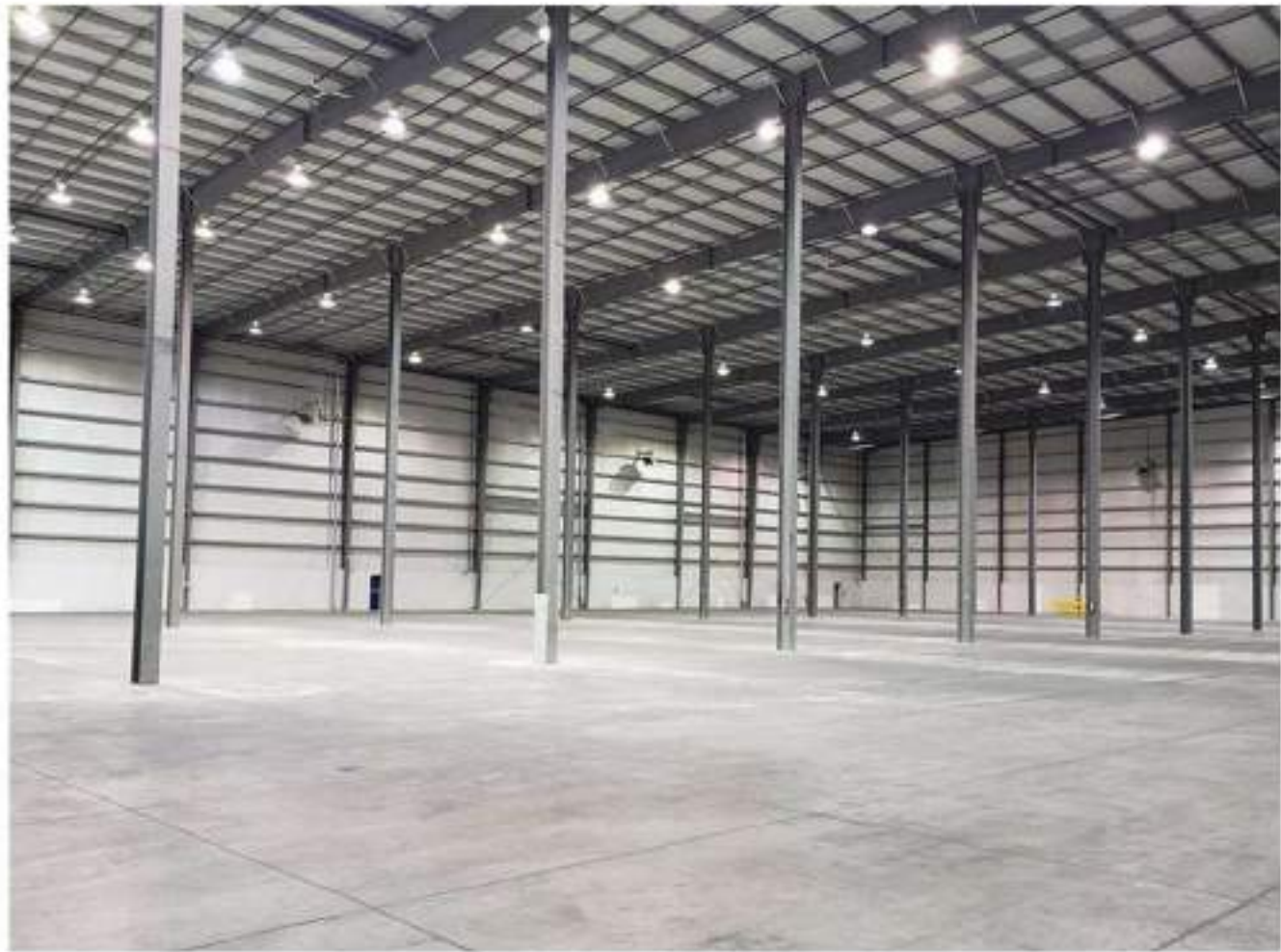

ANKUR XHL 5913



Material	:Aluminium
Brand	:Ankur
Type	:Hanging
Optics	:Clear Glass
Location	:Indoor
Application Area	:Automobiles, Restaurants, Fashion stores etc
Dimension	:(D x H): 470mm x 350mm
Wattage	:50W
Voltage	:140-300V AC
Optics	:Clear
CRI	:0.8
IP	:IP66
LED Type	:SMD
Electronis Driver	:0.95
Operating Temperature	:0°C to 55°C
Colour Temperature:	:3000K / 4000K / 6500K
Lumens Count Per Watt	:105lm / 115lm / 125lm





*One way, Two way
and four way Ground
Burial Lights.....*

Great for driveways, yards, fields, sheds, steps,
porches, overbridge, hall, bathroom and anywhere
you need additional light, or for decoration

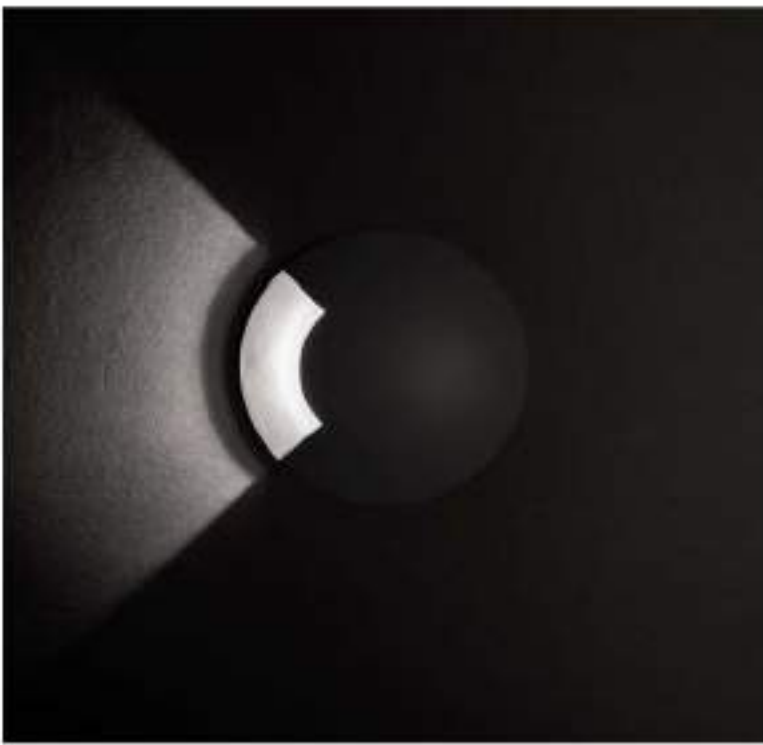

One way

Two way

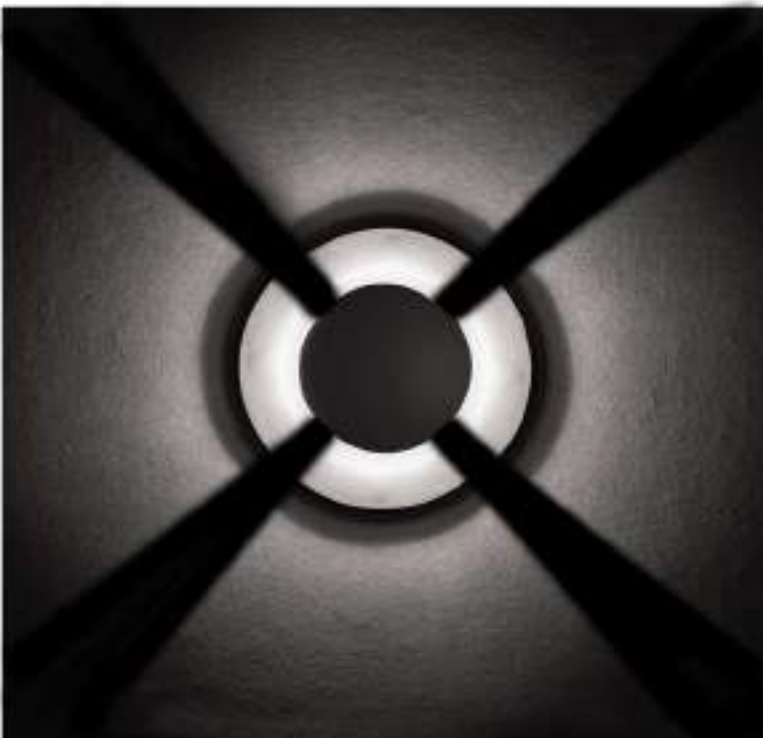

Four way



IP67

One - Way



This outdoor burial light is the best way to add some subtle lighting to outdoor spaces. It guarantees a consistent light distribution on your beautiful outdoor landscapes like gardens and pathways. Ankur products are known for their superior performance, solid built, easy maintenance and long lifespan. This one-way miniature outdoor burial light is one of the best purchases you can be sure of in terms of efficiency and energy-saving as well





Two - Way



This outdoor light is the perfect addition of some discreet ambient lighting to give your outdoor spaces a sense of privacy and seclusion. These are also great for outdoor restaurants. These lights have a superior performance, extremely durable construction, easy installation and longer service life. This two-way miniature outdoor burial light is a purchase you won't regret adding to your beautiful space, be it a house or a commercial space, it works perfectly for both.

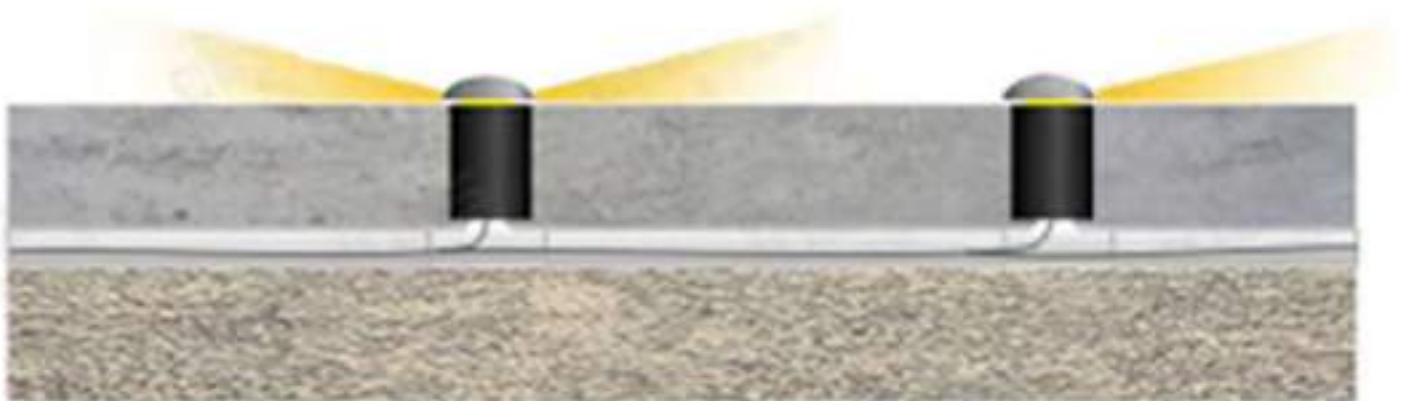



← Fixture

← Jacket

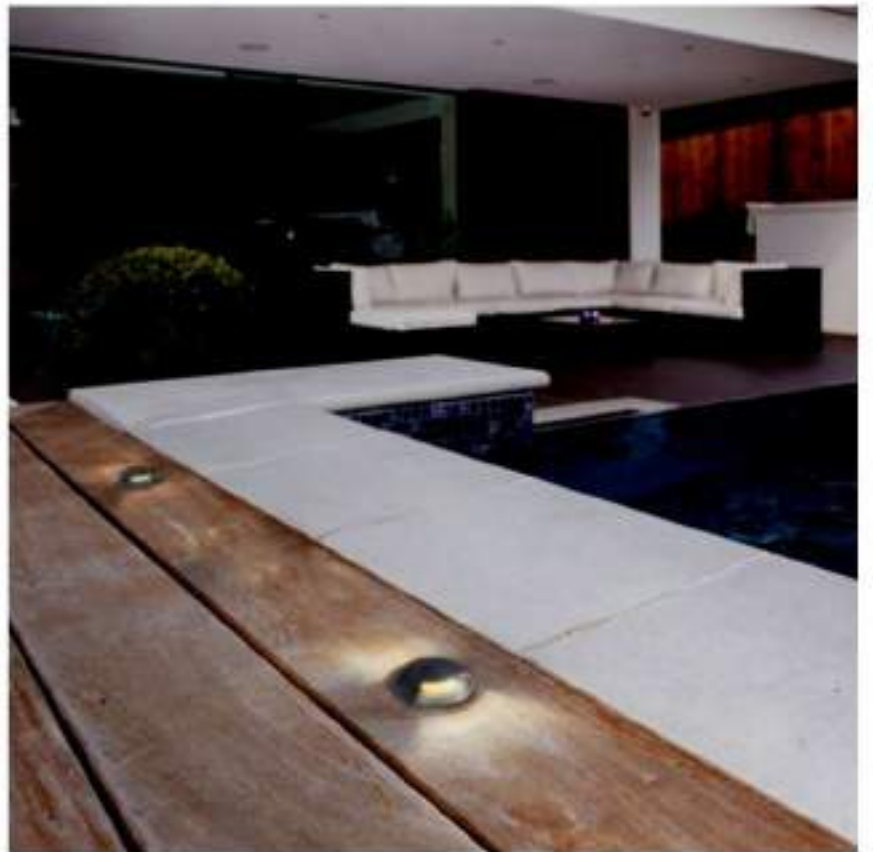



Four - Way



Burial lights have their own way of proving to be resistant to the change of weather conditions by providing consistent performance. These burial lights are commonly used for the purpose of lighting and illuminating pathways of gardens and parks. This 4-way mini burial light is remarkable for voluminous light with bright illumination as per your requirement. These burial lights are elegantly designed to pass every weather test and provide you with a well-lit path for a long time.



ANKUR XOL IP/584 OUTDOOR 6W 3000K 1-WAY LED STEP LIGHT



Material: Pure aluminium alloy or dia cast aluminium alloy shell.
Rotates: fixed
Lamp: COB 1 x 6W
3000K
CRI 80/90
Reflector angle: 90°
AC220V ~50/60Hz
Size: Ø63mm
Cutout: Ø50mm
L:108mm



Available color:



BK



ANKUR XOL IP/584 OUTDOOR 6W 3000K 2-WAY LED STEP LIGHT

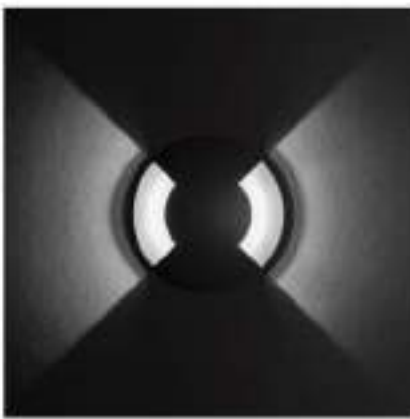

Material: Pure aluminium alloy or dia cast aluminium alloy shell.
Rotates: fixed
Lamp: COB 1 x 6W
3000K
CRI 80/90
Reflector angle: 90°
AC220V ~50/60Hz
Size: Ø63mm
Cutout: Ø50mm
L:108mm

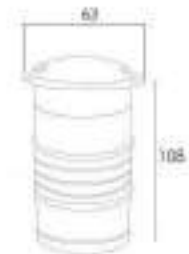

Available color:



BK



ANKUR XOL IP/584 OUTDOOR 6W 3000K 4-WAY LED STEP LIGHT



Material: Pure aluminium alloy or dia cast aluminium alloy shell.
Rotates: fixed
Lamp: COB 1 x 6W
3000K
CRI 80/90
Reflector angle: 90°
AC220V ~50/60Hz
Size: Ø63mm
Cutout: Ø50mm
L:108mm

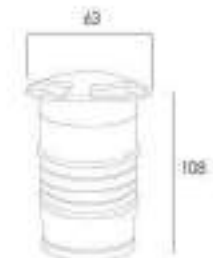

Available color:



BK



Accessories



Jacket

Dimensions: Ø 60mm
H: 118mm

Flood Light



ANKUR FLOOD LIGHT

These outdoor LED flood lights have a high lumen output and CRI. Therefore, they can highlight the true colour of any object. They consume a lesser amount of power as compared to incandescent bulbs and are therefore highly valued by owners of residential & commercial properties. They are suitable for highlighting high street retail stores, and are ideal for usage in gardens, museums, parks, tunnel areas etc. LED flood lights available as a part of this category are waterproof and are therefore suitable for usage throughout the year.

Exploded view



Housing Material:
Aluminium



LED Chips



Waterproof: IP66



ANKUR XOL-LED - IP/0483 30W



Housing Material: Aluminium Die-cast
Cover: Polycarbonate
Wattages: 30W
NO. of leds: 40
Total Luminous: 3300
Type of LED: 2835(9V)
Color temperature: 3000K/ 4000K/ 6500K
Ambient temperature: 0 to 55 Deg C
PF 0.90
IP66
CRI : 0.8
Output Voltage: 30-40 V DC
Output current: 700 mA
Input Voltage: 140-300 V AC
Sizes: 221(L)x40(W)X220(H) mm

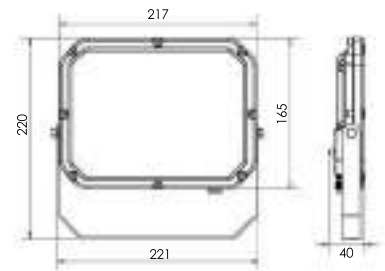

ANKUR XOL - LED - IP/0484 50W



Housing Material: Aluminium Die-cast
Cover: Polycarbonate
Wattages: 50W
NO. of leds: 72
Total Luminous: 5500
Type of LED: 2835(9V)
Color temperature: 3000K/ 4000K/ 6500K
Ambient temperature: 0 to 55 Deg C
PF 0.95
IP66
CRI : 0.8
Output Voltage: 30-40 V DC
Output current: 850 mA
Input Voltage: 140-300 V AC
Sizes: 256(L)x45(W)X251(H) mm

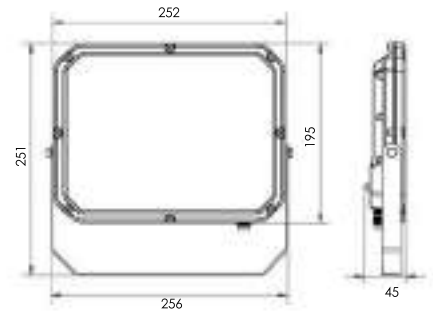

ANKUR XOL - LED - IP/0485 100W



Housing Material: Aluminium Die-cast
Cover: Polycarbonate
Wattages: 100W
NO. of leds: 144
Total Luminous: 11000
Type of LED: 2835(9V)
Color temperature: 3000K/ 4000K/ 6500K
Ambient temperature: 0 to 55 Deg C
PF 0.95
IP66
CRI : 0.8
Output Voltage: 30-40 V DC
Output current: 850 mA
Input Voltage: 140-300 V AC
Sizes: 338(L)x56(W)X307(H) mm

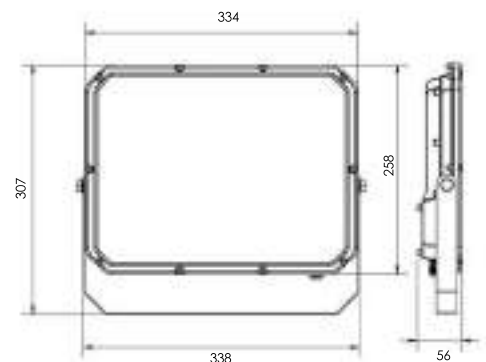

Grazer



ankur
LIGHTING
ANKUR LIGHTING PVT. LTD.
43/302 DLF Phase 2 Gurgaon Haryana India

Wall Grazer

Exterior wall grazing illuminates walls or large surfaces to dramatically accentuate the texture of a wall. Unlike wall washing, wall grazing is intended to reveal the texture of brick, stone or sculptured surfaces. Our outdoor led wall grazers are typically mounted very close to the plane of the wall or fence and direct the light beam obliquely across the subject's surface. Effective wall grazing fixtures deliver high - intensity light in a relatively narrow beam angle.



Grazer

One Meter



Grazer

Half Meter



Grazer

Mini (8")

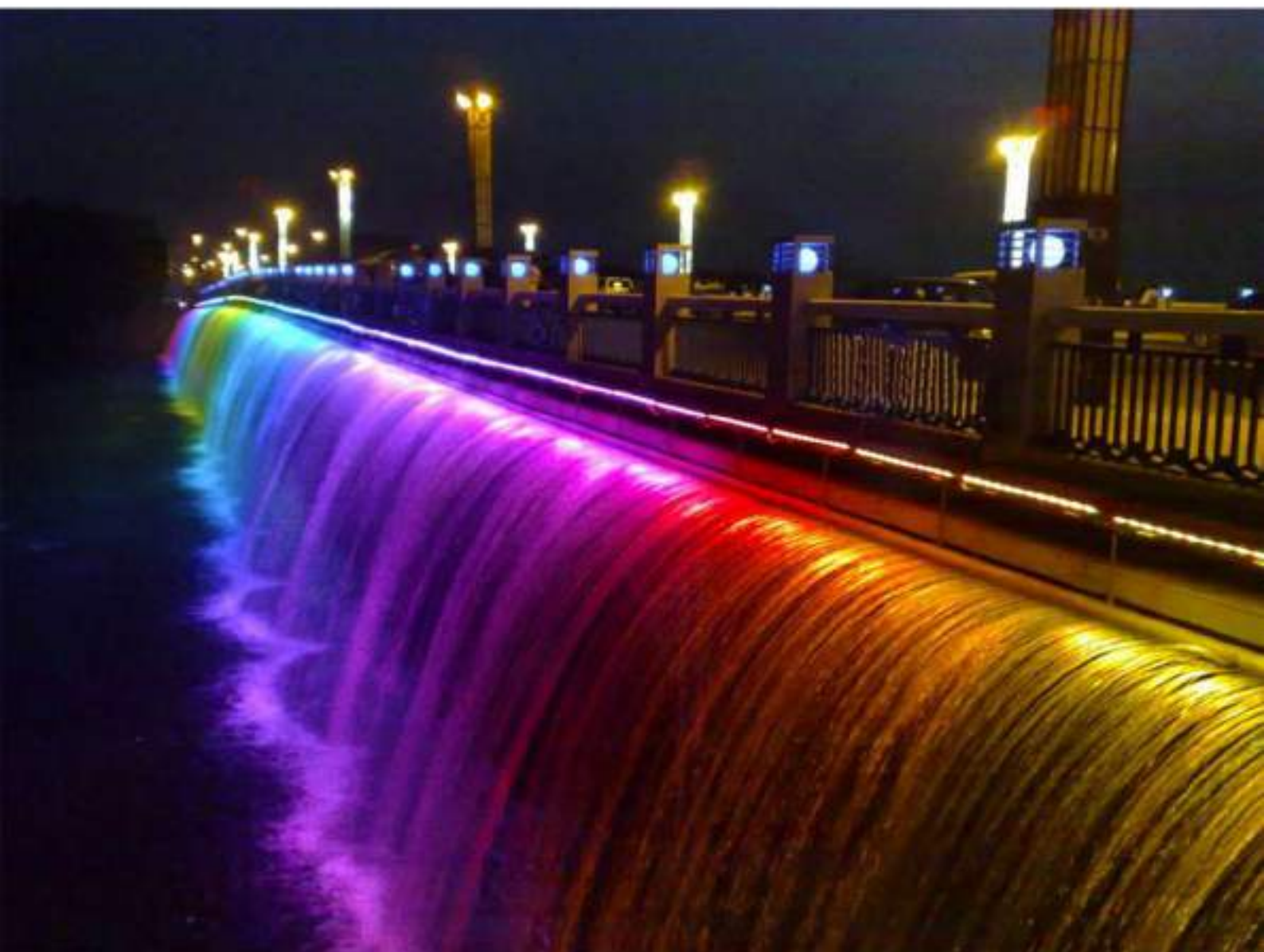
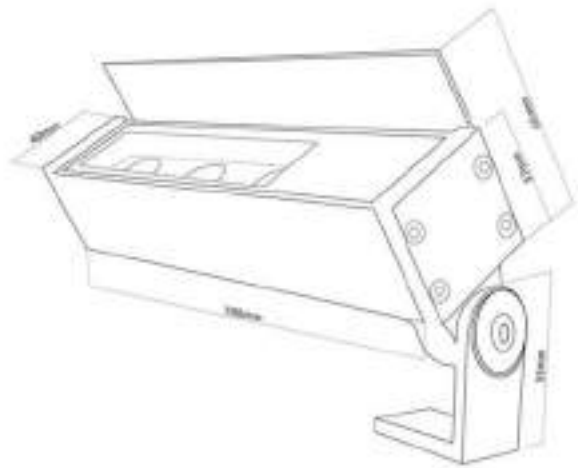

Waterproof

IP66



The lamp body is equipped with multiple waterproof layers to protect the lamp layer by layer against water.



Anti- Rust and Anti- Corrosion Technology

1. High - Temperature Die - casting Aluminum
2. High Corrosion Resistance and weather resistance



High Efficiency LED Lamp Beads

1. High Brightness
2. Low Energy
3. Long Service Life
4. Reliable



Application Areas



For Wall



For House



For Pathways



For Bridges



For Landscape

Features:

LED life:>50000H

Long service life, high luminous efficiency.

Energy-saving and environmentally friendly.

Suitable: Large-scale operational mines/Construction profile/Stadium/exchange/hotel, etc.



ANKUR XOL LED 02/020219 6W 3LP

Wattage: 6W
CCT: 3000K / 4000K / 6500K
Material: aluminium
Rotates: Fixed
Spot headadjust: Fixed

Lamp: SMD

Size: W: 40mm L: 190mm
H: 95mm



Available color:



ANKUR LINEAR WALL GRAZER 02/020218 20W LED HALF METER

Wattage: 20W
CCT: 3000K / 4000K / 6500K
Material: aluminium
Rotates: Fixed
Spot headadjust: Fixed

Lamp: SMD

Size: D: 45mm L: 500mm
H: 110mm



Available color:



ANKUR LINEAR WALL GRAZER 02/020218 40W LED ONE METER

Wattage: 40W
CCT: 3000K / 4000K / 6500K
Material: aluminium
Rotates: Fixed
Spot headadjust: Fixed

Lamp: SMD

Size: D: 45mm L: 1000mm
H: 110mm



Available color:



ANKUR XOL 541



360° / 3000k 

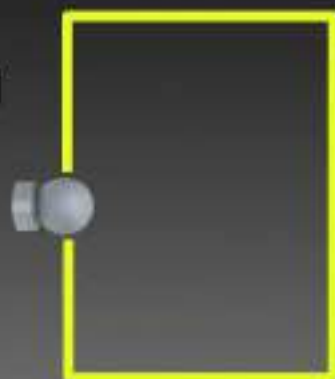

ANKUR XOL 541

Ideal lighting supply to help you achieve the latest graphic lighting. It is the new decorative lighting trend that will create a 3D light-blade like effect, the light will adopt to the frame shape of applied location perfectly, emphasizes each curve and angle, vector surfaces and highlight the texture to the application areas, no dead spot left.



360° / 3000K ■ ■ ■ ■



It is widely used in indoor / outdoor building, for Wall / Passage / stage / Gallery / Parking Lot / Campus decoration.



It is mainly used to highlight buildings on window sills and glass curtain walls, also can be used in tunnels, Culverts or door openings to highlight its outline.

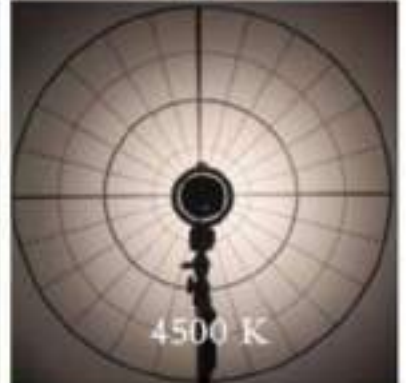
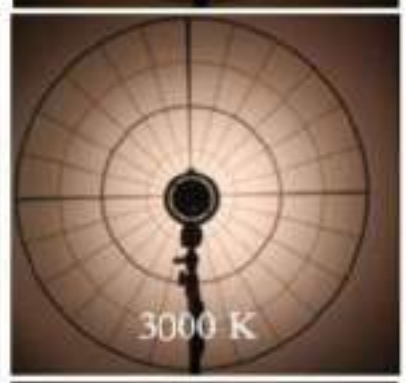



In addition, it can be used in interior corridors to highlight their new visual effects. Each light can be designed so that single colour can create different effects.





LED Trick light is a new type of optical design for decorative blade light effect lighting. it has various advantages like, High brightness, Waterproof , Easy to install, Environment friendly. Lighting effects makes the building more luxurious.

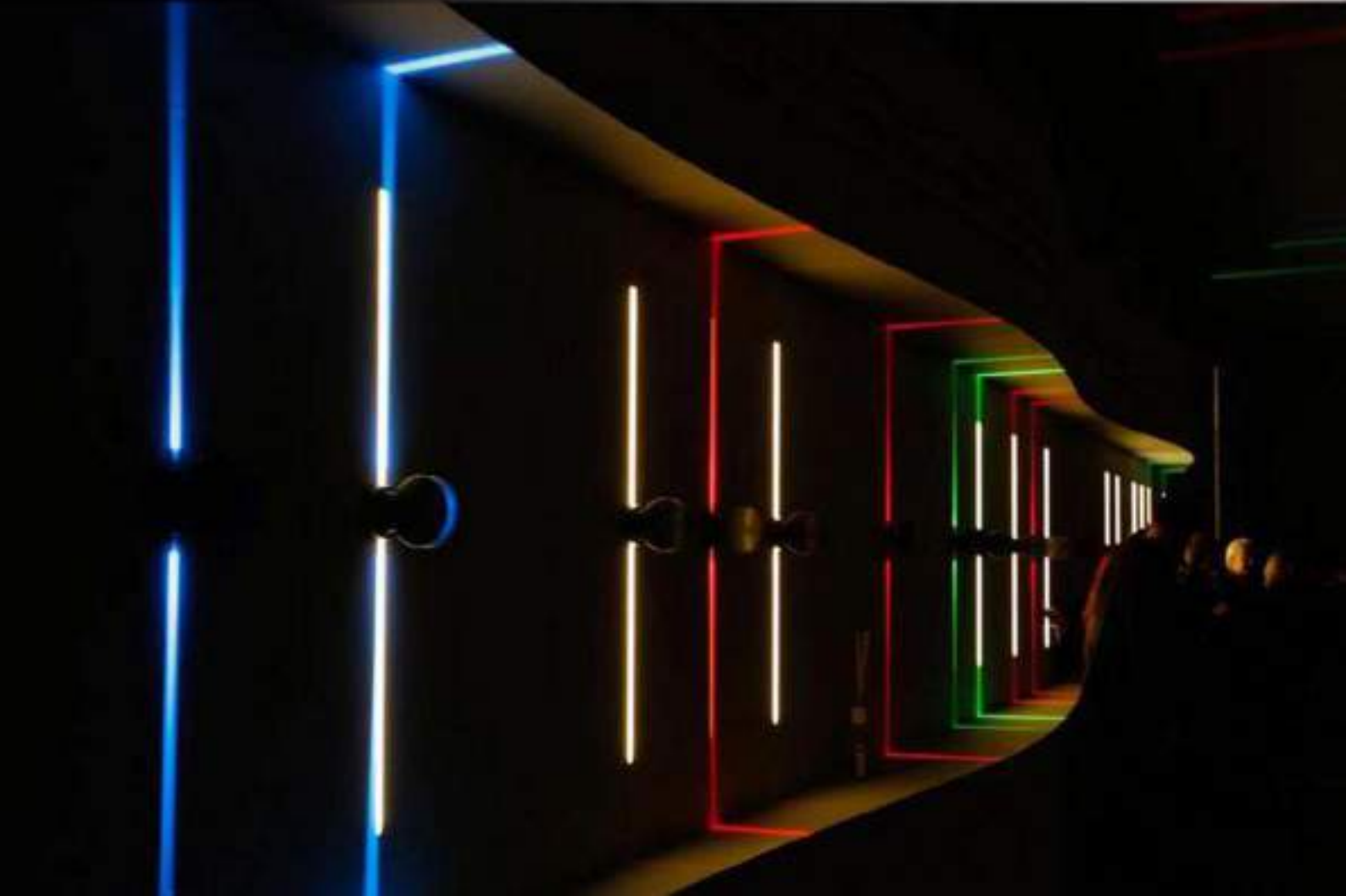

ANKUR XOL 541



Material : Aluminium Die- Cast
Finish : Pearl White / Grey / Black
Power Watt : 9W
Input Voltage : 230V-240V-50Hz
Light Source : 1x 9W LED
Lumens Flux : 612 lm
CCT : 3000K
IP Rating : IP65
CRI 80/90
Size: W:60mm
D:120mm
H:168mm

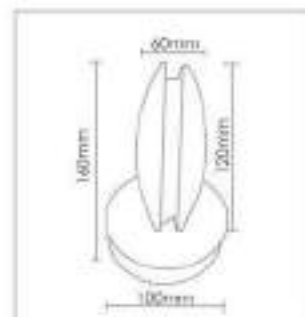

Available color:

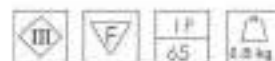

Balino

Outdoor series

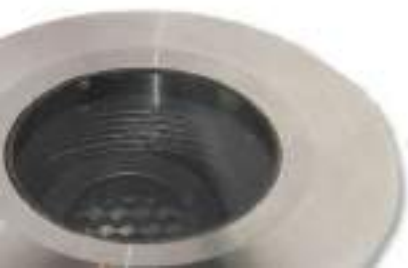

To set your restaurants or business a class apart, add our signature Ankur Balino Outdoor Burial Light. Our burial lights are made to give your porch, backyard or entrance a classic look. This lighting is the first thing that your guests look at, it acts as an attention grabber and a conversation starter.

The lights are built with the strongest and most long-lasting materials so that they stay durable and illuminate your wonderful space.

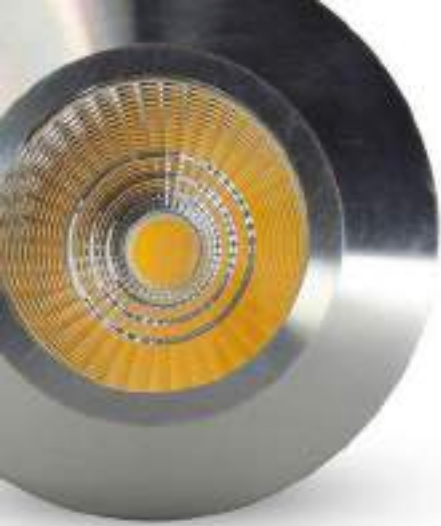

The whole series products using COB LED, which is suitable for outdoor lawn lighting and landscape lighting.
The light has pre Aluminium Alloy oxidation treatments, durable with sophisticated technology.





LED In-ground is designed for floor integration and offers various design possibilities in architectural illumination.



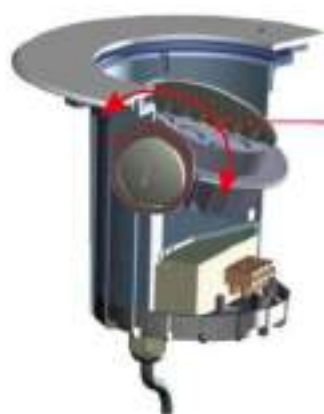

HONEY COMB LOUVER FOR
ANTI-GLARE AND SOFT LIGHT.





- A simplicity of wider angle Adjustment according to the environment require to adjust the angle of light .
- IP classification IP67 for outdoor use.

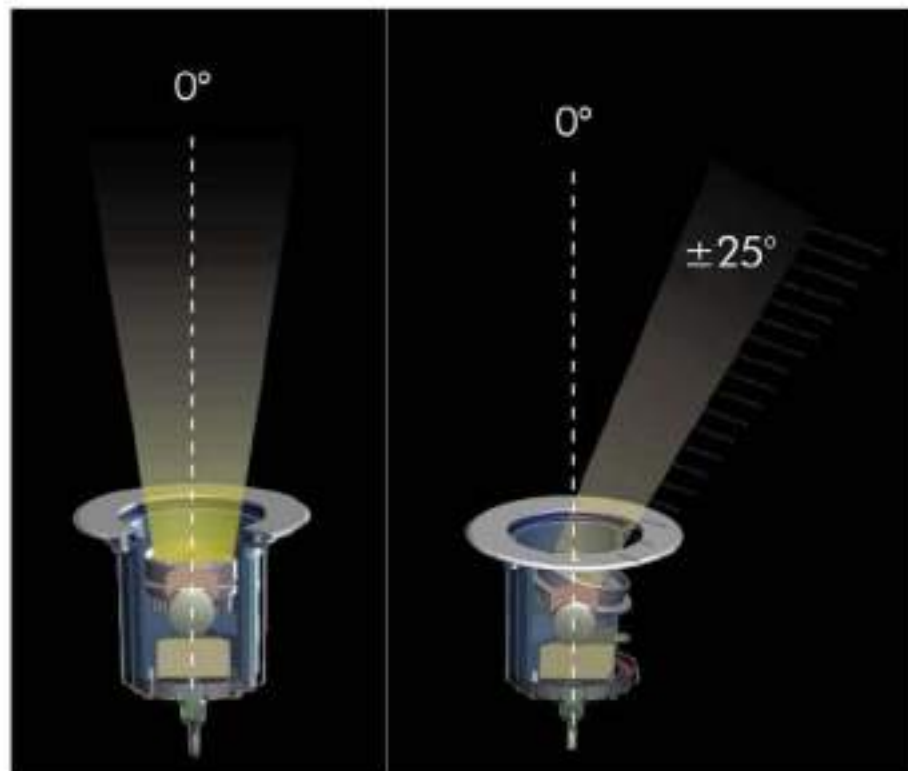



The light has dual performance as it can be fixed or can be tilted to focus the target object.





It plays a crucial role in brightening up and highlighting the exterior architecture of your home or office. Strategically done outdoor lighting can give a whole new look to your facade and make your porch, patio, landscape area more attractive. Not just for decorative purpose, outdoor lights are important for security purposes also to illuminate the dark areas of your home at night.

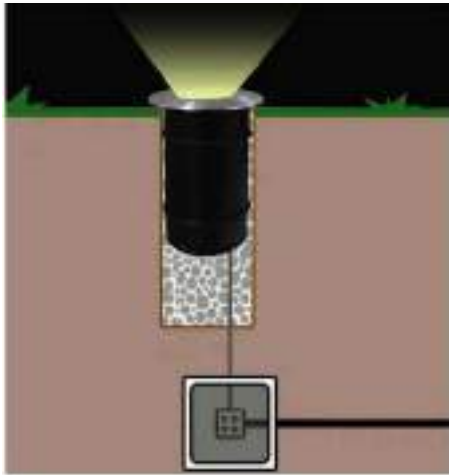

ANKUR XOL LED- IP/717 9W

Material: Pure aluminium alloy or dia cast aluminium alloy shell.

Rotates: fixed

Spot head adjust: fixed

Lamp: COB 1x9W
3000K / 4000K / 6000K
CRI 80/90

Reflector angle: 14°, 24°, 36°, 60°

AC220V ~50/60Hz

Size: ø:80mm

L:140mm

Cutout: ø:60mm



Available color:



WH



BK



SV

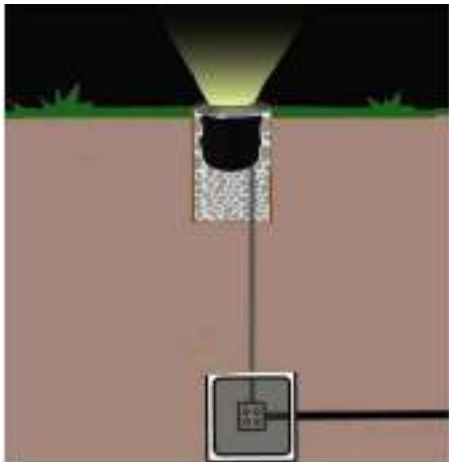

ANKUR XOL LED- IP/717 6W

Material: Pure aluminium alloy or dia cast aluminium alloy shell.

Rotates: fixed

Spot head adjust: fixed

Lamp: COB 1x6W
3000K / 4000K / 6000K
CRI 80/90

Reflector angle: 14°, 24°, 36°, 60°

AC220V ~50/60Hz

Size: ø:78mm

L:65mm

Cutout: ø:60mm



Available color:



WH



BK



SV

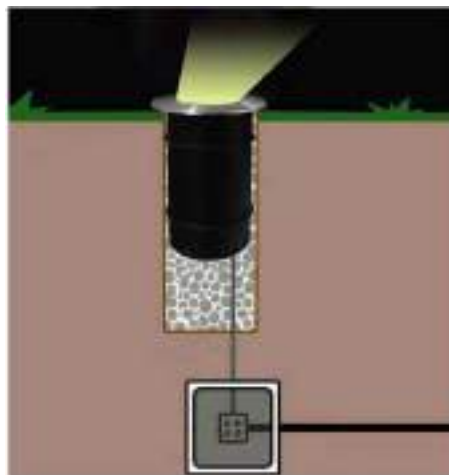

ANKUR XOL LED- IP/717 9W

Material: Pure aluminium alloy or dia cast aluminium alloy shell.

Rotates: fixed

Spot head adjust: fixed

Lamp: COB 1x9W
3000K / 4000K / 6000K
CRI 80/90

Reflector angle: 14°, 24°, 36°, 60°

AC220V ~50/60Hz

Size: ø:80mm

L:140mm

Cutout: ø:60mm

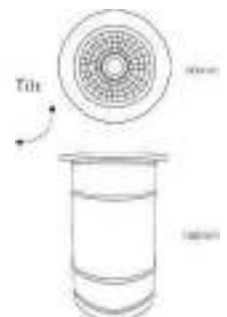

Available color:



WH



BK



SV



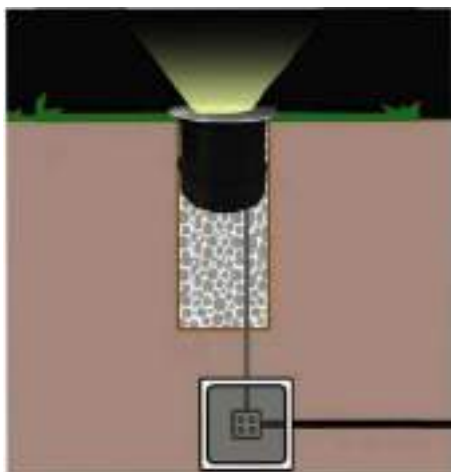

ANKUR XOL LED-IP/718 18W

Material: Pure aluminium alloy or dia cast aluminium alloy shell.

Rotates: fixed

Spot head adjust: fixed

Lamp: COB 1x18W
3000K / 4000K / 6000K
CRI 80/90

Reflector angle: 14°, 24°, 36°, 60°

AC220V ~50/60Hz

Size: ø:125mm

L:130mm

Cutout: ø:95mm



Available color:

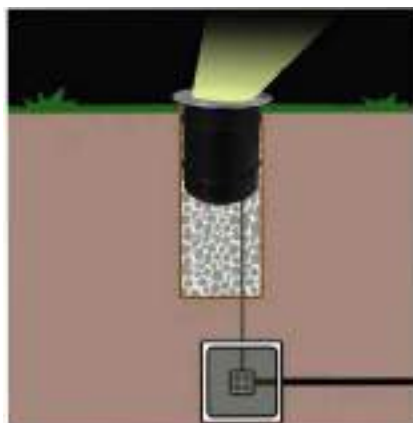

ANKUR XOL LED-IP/718 20W

Material: Pure aluminium alloy or dia cast aluminium alloy shell.

Rotates: fixed

Spot head adjust: fixed

Lamp: COB 1x20W
3000K / 4000K / 6000K
CRI 80/90

Reflector angle: 14°, 24°, 36°, 60°

AC220V ~50/60Hz

Size: ø:125mm

L:130mm

Cutout: ø:95mm

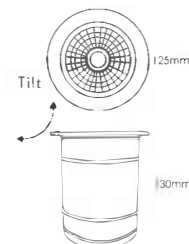

Available color:

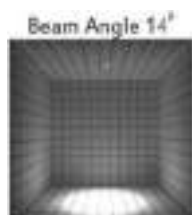

ANKUR GEL

KLICK



ANKUR GEL KLIKK

- Easy installation.
- Environmental-friendly and energy saving.
- Long lifespan and stable performance.
- Waterproof and dust proof.
- Perfect for outdoor lighting such as landscape, garden, swimming pool, etc.



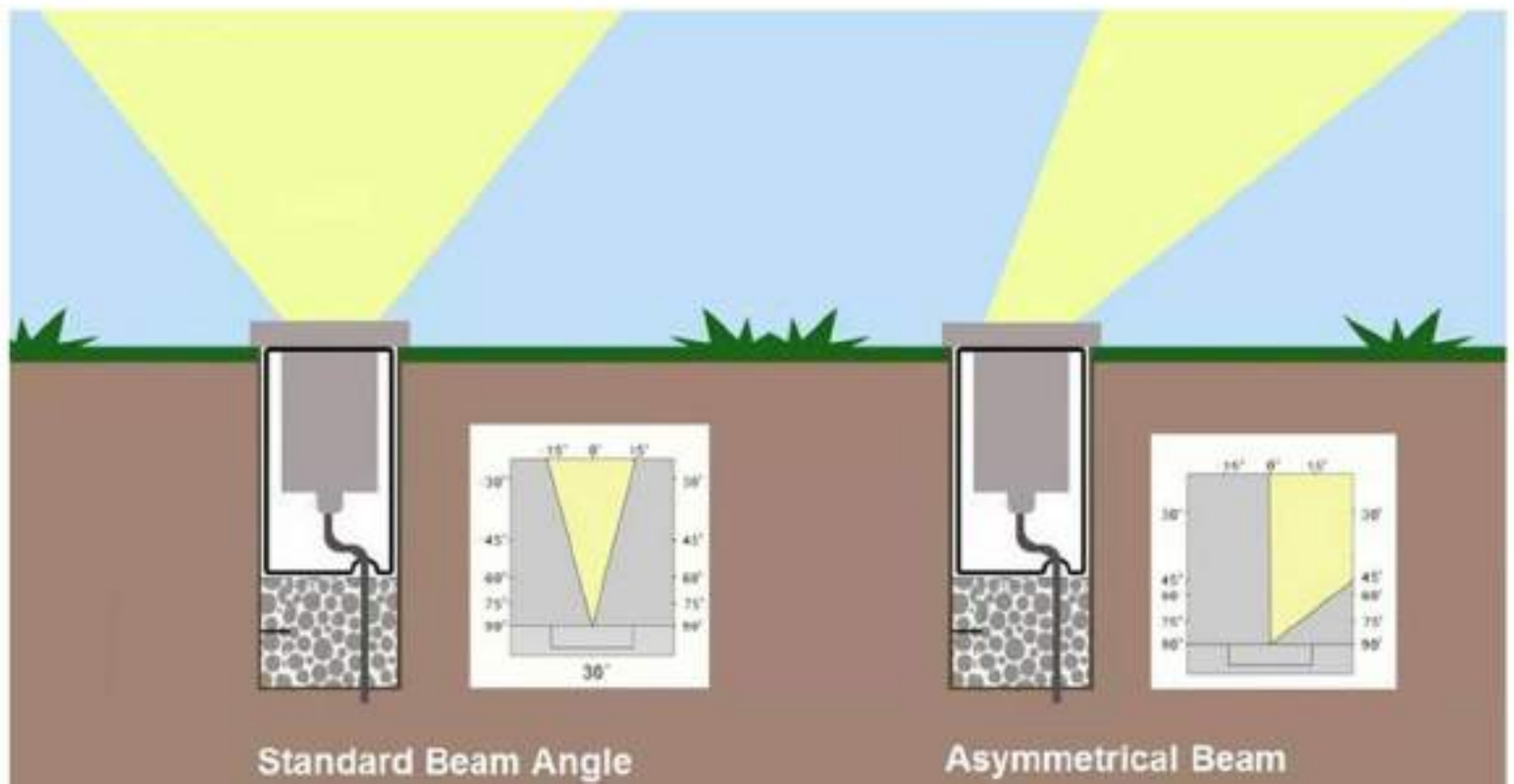
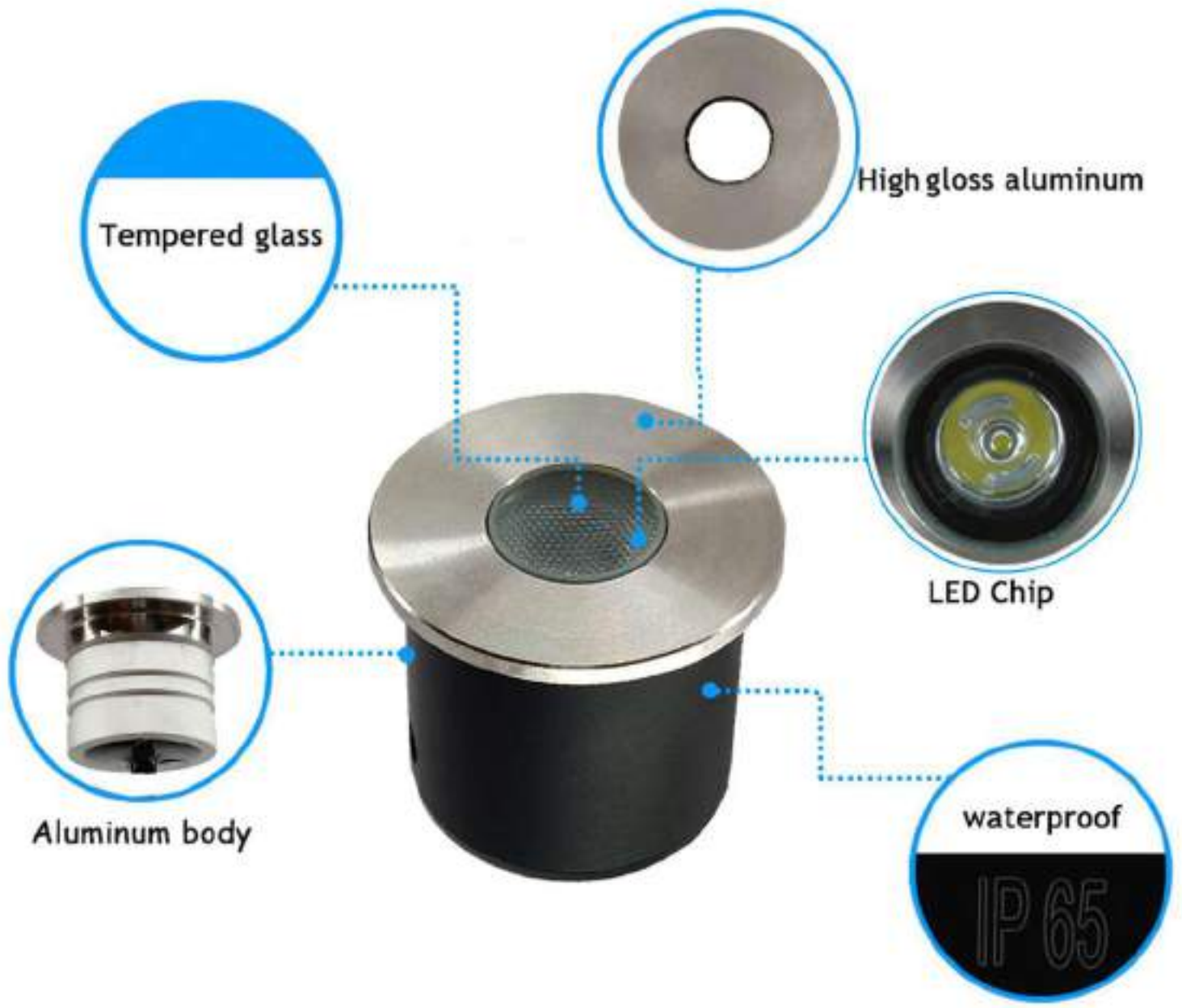

COMPACT &
STYLISH





Features:

- 1. The lamp body is small, flexible application.**
- 2. Optional light color is rich, there are warm white, cool white, blue, green, red.**
- 3. 3°, 24°, 60° beam angle options.**
- 4. IP65 degree of protection.**
- 5. Surface can withstand pressure upto 100kg.**
- 6. Protection class IP65, can be used 1 meter underwater.**
- 7. Light aluminium body with anti corrosion finish.**
- 8. Low voltage input, safe and reliable.**



APPLICATION AREAS:

Parking entrance, roads, squares, sidewalks, gardens, swimming pools, bridges and other outdoor venues.

ANKUR XOL - LED - IP/712



Wattage: 1W
Material: Aluminium Body
Optics: polycarbonate diffuser
CRI: 80/90
Lumens Per watt: 100lm/ 105lm/ 110lm
Color Emits: Red, Blue, Green, Yellow, white
Diameter: 30mm
Height : 55mm
Cutout: 28mm



ANKUR XTR - LED - IP/713



Wattage: 2.5W
Material: Aluminium Body
Optics: polycarbonate diffuser
CRI: 80/90
Lumens Per watt: 100lm/ 105lm/ 110lm
Color Emits: Red, Blue, Green, Yellow, white
Diameter: 45mm
Height : 37mm
Cutout: 36mm

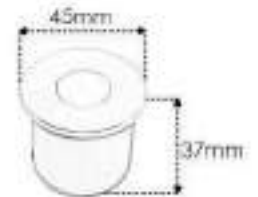

ANKUR XTR - LED - IP/713



Wattage: 2.5W
Material: Aluminium Body
Optics: Clear Glass
CRI: 80/90
Colour Temperature: 3000K/ 4000K/ 6500K
Lumens Per watt: 100lm/ 105lm/ 110lm
Reflector angle: 3°/ 24°
Diameter: 45mm
Height : 37mm
Cutout: 36mm

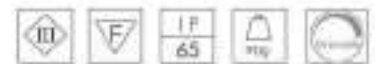

ANKUR XOL-LED-IP/714



Wattage: 2.5W
Material: Die Cast Aluminium Body
Optics: Clear Glass
CRI: 80/90
Colour Temperature: 3000K/ 4000K/ 6500K
Lumens Per watt: 100lm/ 105lm/ 110lm
Reflector angle: 10°/ 24°
Diameter: 45mm
Height : 60mm
Cutout: 36mm

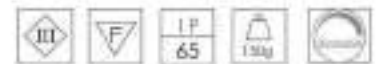

ANKUR LED LDL-0102



Wattage: 6W
Material: Aluminium Body
Optics: Clear Glass
CRI: 80/90
Colour Temperature: 3000K/ 4000K/ 6500K
Lumens Per watt: 100lm/ 105lm/ 110lm
Reflector angle:
Diameter: 60mm
Height : 78mm
Cutout: 52mm



Outdoor SERIES



B
A
S
E
M
O
U
N
T
E
D

S
P
I
K
E
L
I
G
H
T



This compact spotlight can be used either as a wall spotlight or as a practical garden light. A ground spike is included in the set and gives stability to the outdoor light, irrespective of the soil condition. Thanks to the extra high IP code IP65, this model is resistant not only to dust and dirt, but also to the ingress of jet water.

This ANKUR light is a sleek up & down wall light, the perfect feature to bring your outdoor space to life. It can be illuminated upward and in both upward and downwards directions creating columns of light for dramatic effect. It's simple lines also fit with many other styles of lighting, blending or creating an impact, this fitting does both!



U
P
·
D
O
W
N

WALL GRAZER



Grazer LED Light fixture is perfect for a large range of façade or surface illumination applications.



Ground spike light is primarily suitable for the targeted highlighting of garden decorations or other objects. It can also be used as a flexible element of the general lighting outdoors - for example, if the light is directed against a wall that has been plastered in a light colour and this is used as reflector. The garden spotlight with an understated design blends into a variety of garden concepts.



This light also to be mounted onto walls and solid floors.



— Steady Fixing Screw



— Painted Aluminum to prevent Rust



— First Class LED COB chip with high lumen



— Waterproof Rubber Ring







UP-DOWN LIGHT

SPECIFICATIONS

- Housing: Die-cast aluminum.
- Outdoor Wall Cylinders.
- Finish: black body finish.
- LED: COB technology.
- Input voltage: 120V.
- Wattage:
- Beam angle: 40° for each side.
- CRI: >80.
- IP65, providing a reliable weather-tight seal.





Two way

Super Bright IP65 LED Outdoor Wall Light .

1. Chosen High Quality Material
2. Outdoor Using Product
3. Better Application for many Environment
4. Easy Installation
5. Safety and Waterproof, Adapt in most Environment Easily
6. Simple and Elegant, Fashion and Classic
7. Long Life Span for Light Case Product Features:

Wall Lamp Light LED Light Warm white Light 85-265V

AC black silvery Aluminum, Glass

Die Casting, Paint



One way



- Easy to install, Long lasting brightness
- Widely used for exterior and interior decoration such as at home , hotel, clubs, shopping mall. Popular applied in display racks, photo frames, stairs, main gate, walls, entrance.

Mini- One way



Features:

- 6W LED wall lamp, excellent IP65 waterproof properties.
- High quality aluminum alloy material.
- Glow single side
- Low power consumption, extremely long life more than 50,000 hours. Easy to install, convenient to use.
- Modern minimalist design, great for Deck backyards' outdoor for restaurant, bar, cafe, hotel, landscape, etc.
- Widely use in outdoor lighting and decoration.







Wall Grazer

Features:

High quality lamp beads, with aluminium housing.
Standard IP65 protections, tempered glass mask.
Evenly concentrated lights, long illumination distance,
high colour rendering.
Silicon infusion, waterproof PC, dustproof, and rainproof.

LED type - SMD



Thick aluminium base



Waterproof Design









ANKUR XOL - LED - IP/00102 3W-6W

Wattage: 3W - 6W
CCT: 3000K / 4000K / 6500K
Material: aluminium
Rotates: Fixed
Spot headadjust: Fixed

Lamp: 1x COB

Size Head: \varnothing : 38mm H: 135mm
Base: \varnothing 105mm H: 55mm

Available color:

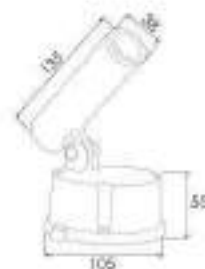

ANKUR XOL 102 3W-6W SPIKE LIGHT

Wattage: 3W-6W
CCT: 3000K / 4000K / 6500K
Material: aluminium
Rotates: Fixed
Spot headadjust: Fixed

Lamp: 1x COB

Size Head: \varnothing : 35mm H: 135mm
Height: 260mm

Available color:



ANKUR LINEAR WALL GRAZER 02/020218 20W LED

Wattage: 20W
CCT: 3000K / 4000K / 6500K
Material: aluminium
Rotates: Fixed
Spot headadjust: Fixed

Lamp: 1x SMD

Size: D: 45mm L: 500mm
H: 110mm

Available color:

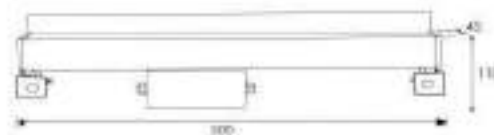

ANKUR XOL - LED - IP/0087 SINGLE SIDE 6W



Wattage: 6W
CCT: 3000K / 4000K / 6500K
Material: aluminium
Rotates: Fixed
Spot head adjust: Fixed
Optics: TIR
Beam Angel: 40°
Size : Ø: 42mm H: 65mm L: 90mm
Colour temperature: 3000k
Lumens per watt: 111
Available color:

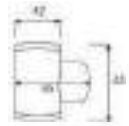

ANKUR XOL - LED - IP/0083 SLIM DOUBLE SIDE 2 X 6W



Wattage: 2 X 6W
CCT: 3000K / 4000K / 6500K
Material: aluminium
Rotates: Fixed
Spot headadjust: Fixed

Lamp: 1x COB

Size Head: Ø: 60mm H: 158mm W: 123mm

Available color:

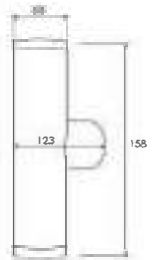

ANKUR XOL - LED - IP/0083 SLIM SINGLE SIDE 6W



Wattage: 6W
CCT: 3000K / 4000K / 6500K
Material: aluminium
Rotates: Fixed
Spot headadjust: Fixed

Lamp: 1x COB

Size: D: 60mm L: 164mm W: 123mm

Available color:

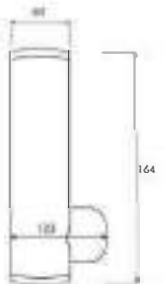

ANKUR XOL - LED - IP/0083 SLIM DOUBLE SIDE 2 X 12W



Wattage: 2 X 12W
CCT: 3000K / 4000K / 6500K
Material: aluminium
Rotates: Fixed
Spot headadjust: Fixed

Lamp: 1x COB

Size: D: 38mm H: 225mm W: 75mm

Available color:

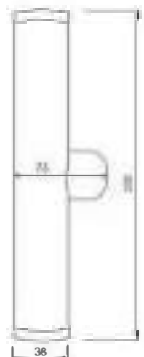

SPIKE LIGHT WITH COWL NECK



Ankur Lighting Outdoor spotlight in a modern black finish will add Style to any outside setting. With a hardwearing die-cast aluminium casing and an IP67 rating, it is weatherproof and robust. It is not However recommended for coastal locations. Thanks to its 90 degree adjustable tapered head, the light direction can be fully controlled.



Features

- The spotlights can be inserted into the ground or screwed on a level surface
- Die-cast aluminium garden spotlight in a metallic black finish
- Built-In HIGH Quality LED driver
- IP67 rated- Water & Dirt Resistant
- Head can be adjusted to a max 90°
- High Performance COB LED Chip



High Quality COB Chip



Spot Head Adjustable



Honeycomb Lens



Mounting Base



Aluminium Body



Spike



IP67





Insert Into the ground

Insert it into the ground with the supplied ground spike



Multiple installation methods

Fix on the wall

Install it on the wall using the supplied wall bracket



ANKUR XOL 111 15W OUTDOOR SPIKE LIGHT WITH COWL NECK

Wattage: 15W
CCT: 3000K
Material: Aluminium
Rotates: Fixed
Spot head adjust: Tiltable

Lamp: 1x COB

Size Head: Ø: 75mm L: 145mm
Height: 290mm

Available color:

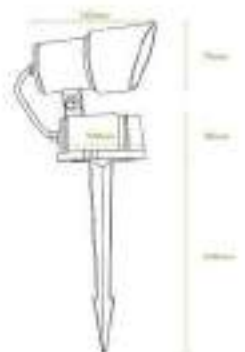



ankur
LIGHTING
An ISO 9001:2008 Certified Company

SILICON SQUARE NEON LIGHT



Product features:

- Self-made LED chips with high brightness
- Easy installing for many ways
- Any cut
- Adjustable for all kinds of LED decorations
- Safety input 24VDC
- Certified by CE, RoHS, 2 years warranty



Specifications

ITEM	VOLTAGE	LM/M	POWER	LUMEN
2835-120L-24V SILICON	DC 24V	600LM	7 W	85LM/W
SIZE	PCB WIDTH	WATERPROOF	CUT UNIT	PACKING
1000x10x10MM	8MM	IP67	any cut	20M/ROLL

Aluminum Profile Installation

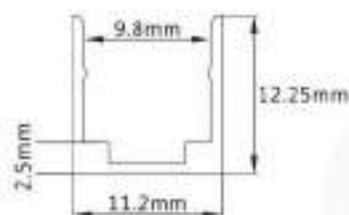

Aluminum Profile Dimension



① Drill two holes on aluminum profile and install on wall with screws



② Put neon light into aluminum profile

Power Connect Instruction

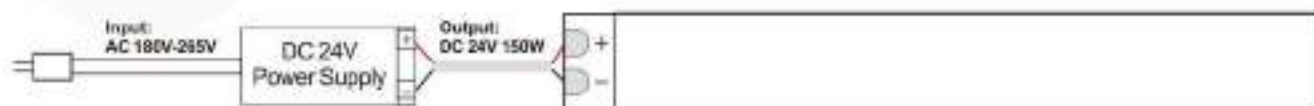

⚠ Attention



24V

2835-120L

540 Lm/M

8W/M

80

IP 65

DC 24V

3000K / 4000K / 6000K



PRODUCT DATA SHEET

ANKUR BEDSIDE PULL-OUT LED WALL LIGHT

DESCRIPTION

Wall lights are a great way to spice up any home and achieve a splendid interior design that looks well-thought-out. This chic and slender piece brings to you a modern and contemporary touch that fits just right in spaces that do not receive enough natural light. The light was manufactured with brilliant quality material and is made to last a great deal of time with the same performance quality as day one. Add this stylish design to your room for a sweet and cosy look



DETAILS & SPECIFICATIONS

Material	: Aluminium
Brand	: Ankur
Finish	: Black / Brushed Copper / Silver / White
Mount Type	: Wall Mount
Application Area	: Hotel, Restaurant, Office, Bed Room, etc

Dimension (WxH)	: 68mm x 170mm
Wattage	: 3W
Voltage	: 700ma
Optics	: Clear Glass Lens
CRI	: >80
IP	: IP54
LED Type	: COB
Electronics Driver	: Philips / Fulham / Osram / Ankur
Operating Temperature	: -20°C to +55°C
Colour Temperature:	: 3000K
Lumens Count Per Watt	: 105lm

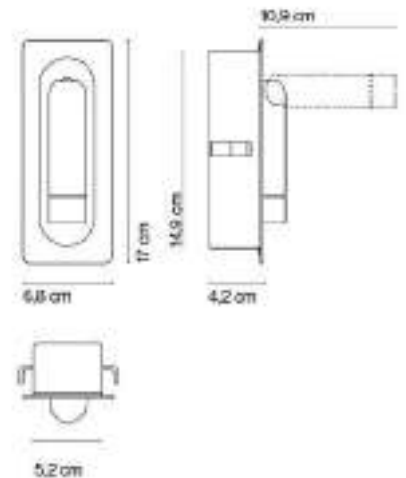

PRODUCT DATA SHEET

ANKUR TRAZOR HANIGING LIGHT

ANKUR XHL LED IP/2523

DESCRIPTION

This minimalist design brings to you a fashionable yet simple look that will enhance the overall beauty of your home. For a modern and stylish look that also balances the homely feeling, this design will create elegance and an inviting environment in any part of your home. To suit your designing dreams the best, this vintage hanging is available in three gorgeous colours which are red, black and white; so you can decide the one that suits your vibrant personality the best.



DETAILS & SPECIFICATIONS

Material	: Aluminium
Brand	: Ankur
Type	: Hanging
Optics	: Clear Glass
Location	: Indoor
Application Area	: Offices, Hotels, Restaurants, Hospitals, Home etc.

Dimension	: Diameter: 255mm, Height: 235mm
Wattage	: 20W / 30W
Voltage	: AC100-240V
Optics	: Clear Glass
CRI	: >90
IP	: IP20
LED Type	: COB
Electronis Driver	: Philips / Fulham / Osram / Ankur
Operating Temperature	: -20°C to +55°C
Colour Temperature:	: 3000K / 4000K / 65000K
Lumens Count Per Watt	: 105lm / 115lm / 125lm

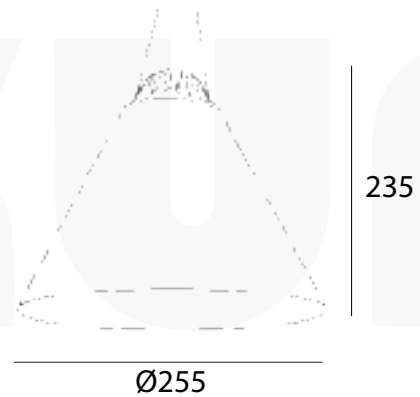



for more information please visit
www.ankurlighting.com

