

MPIII Temperature Data Logger

DataTrace® MPIII

Micropack III Temperature Data Logger

From chilling, freezing and room temperature to pasteurization, EtO sterilization and depyrogenation, MPIII Temp, HiTemp and HiTemp EXT Loggers provide accurate data over a wide range with remarkable ease. Their small size increases versatility and precision by allowing you to position Loggers very near or inside monitored items.

- 17 Point Temp NIST Traceable Calibration
- FDA 21 CFR Part 11 Compliant Software
- Intrinsically Safe

DataTrace makes it easy to monitor processes across a spectrum of temperatures in industries and situations **such as:**

- Pharmaceuticals
- Food and beverages
- Medical
- Sterilizer validation
- Thermal processing for electronic, chemical, aerospace and other industries
- Process equipment and sterilization
- Product handling and storage
- Textile manufacturing



MPIII Temp Datalogger

DT Pro Software

DataTrace's highly secure, FDA 21 CFR Part 11 compliant DT Pro software offers reports in any format you require. Password protected access, electronic signatures and automatic documentation for audit trails streamline your work. You can even synchronize multiple loggers (in any combination of logger types) to the same clock; something disparate systems can't do.

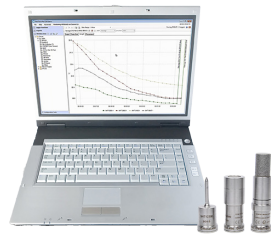

- Customize reports
- Password protected access
- Electronic signatures
- Automatic documentation

Features / Options	Temp Logger, Dual Temp Logger
<i>Probe Type</i>	Rigid, Bendable or Flex
<i>Rigid Probe Lengths</i>	1 - 5", custom
<i>Flexible Probe Types</i>	Silicone, Stainless Steel
<i>Flexible Probe Tips</i>	Needle, Taper (Silicone Only)
<i>Flexible Probe Lengths</i>	8", 14", 25", custom
<i>Bendable Probe Lengths</i>	10", 14", 25", custom
<i>Bendable Probe Tips</i>	Round
<i>Sensor Element</i>	Thermistor or RTD

*HiTemp & HiTemp EXT Loggers require a Thermal Pack for use above +140°C.

**Size and weight are shown for Logger body only.

All specifications subject to change without notice. DataTrace is a registered trademark and Micropack III is a trademark of Mesa Laboratories, Inc. All other trademarks and registered trademarks are the sole property of their respective owners.

© Copyright 2017 Mesa Laboratories, Inc.



21 CFR Part 11 Compliant

MPIII Temperature Data Logger

Product Specifications

Size: Width: 0.7 in. (18mm) Length: 0.9 in. (23mm)**

Weight: 0.5 oz. (15 grams)**

Material: 316 stainless steel; Sapphire IR windows

Memory: 16,000 time/temperature observations

Sample rates: Operator programmable 1 sec. to 1 hr. intervals

Operating Temperatures:

MPIII Temp and MPIII Dual Temp: -20°C (-4°F) to +140°C (+284°F)

MPIII HiTemp*: +100°C (+212°F) to +360°C (+680°F) w/Thermal Pack

MPIII HiTemp EXT*: -20°C (-4°F) to +400°C (+752°F) w/Thermal Pack

Resolution: 0.001°C

Temperature Accuracy:

MPIII Temp/Dual: $\pm 0.1^\circ\text{C}$ ($\pm 0.2^\circ\text{F}$)

MPIII HiTemp*: $\pm 0.5^\circ\text{C}$ ($\pm 0.9^\circ\text{F}$)

MPIII HiTemp EXT*: $\pm 0.25^\circ\text{C}$ ($\pm 0.45^\circ\text{F}$); $<200^\circ\text{C}$ (392°F) $\pm 0.5^\circ\text{C}$ ($\pm 0.9^\circ\text{F}$); $\geq 200^\circ\text{C}$ (392°F)

Operating Pressure: For all 3 models: Up to 10 Bar

Calibration: Factory calibrated (NIST traceable)

Field calibration (MPIII Temp/Dual only)

Battery Type: Lithium (field-replaceable)

Clock accuracy: 26 seconds per 24 hours

Certifications: ATEX (for intrinsic safety)

MPIII Rigid with Taper Tip and Optional Bullet Tips

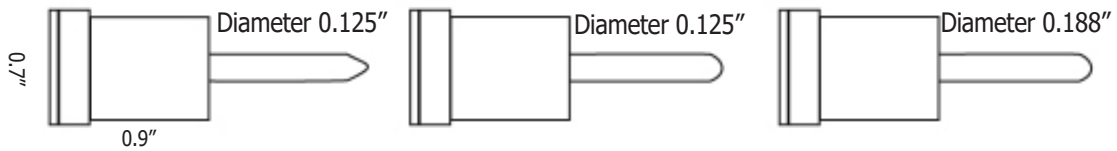

MPIII Silicone Flex with Taper Tip

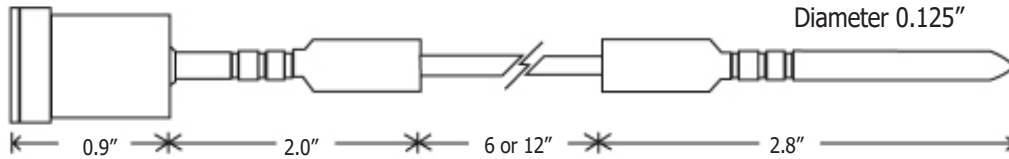

MPIII Silicone Flex with Needle Tip

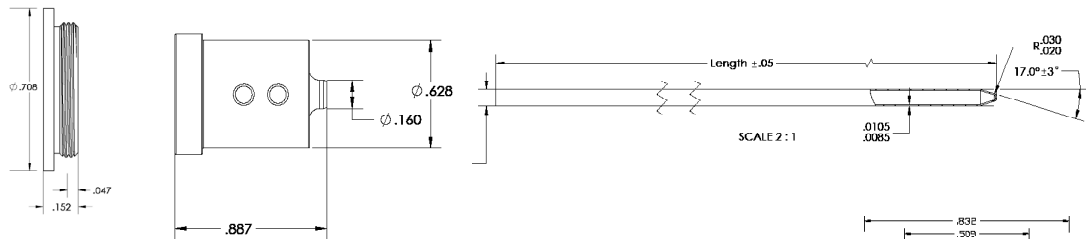
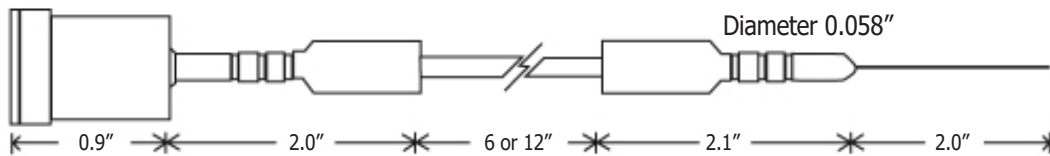

MPIII Dual Bendable TEMP

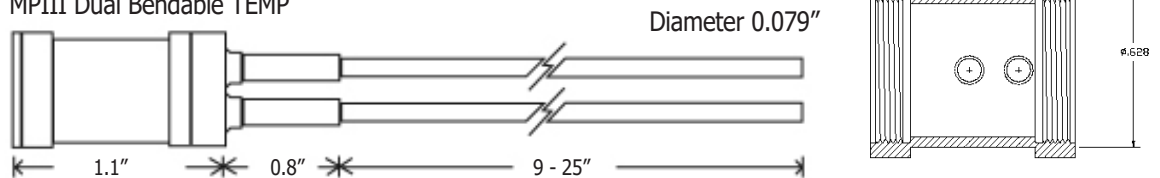

MPIII Humidity Data Logger

DataTrace® MPIII Micropack III Humidity Data Logger

For processes that are sensitive to humidity, even small RH changes can dramatically affect product production, storage and shipping. The highly accurate MPIII Humidity Logger monitors RH across the full range, from 0% to 100% at temperatures from 0°C (32°F) to 85°C (185°F).

- Accurate Across Full RH Range
- 18 Point Humidity NIST Traceable Calibration
- 10 Point Temp NIST Traceable Calibration
- FDA 21 CFR Part 11 Compliant Software



MPIII Humidity Data Logger

Collect and log accurate RH data in varied industries and situations, including:

- Pharmaceutical, Production Monitoring
- EtO Sterilization
- Sterilizer Validation
- Food Production/Drying
- Incubator Validation
- Critical Product Shipments

DT Pro Software

DataTrace's highly secure, FDA 21 CFR Part 11 compliant DT Pro software offers reports in any format you require. Password protected access, electronic signatures and automatic documentation for audit trails streamline your work. You can even synchronize multiple loggers (in any combination of logger types) to the same clock; something disparate systems can't do.



- Customize reports
- Password protected access
- Electronic signatures
- Automatic documentation

Product Specifications

Range

Operating Temperatures: +0°C to +85°C (+32°F to +185°F)
Temperature Accuracy: ± 0.1°C (±.2°F)
Operating Humidity: 0% to 100% RH (non-condensing)
Humidity Accuracy: ±2% RH, 0% to 100% non-condensing at +25°C and +55°C (±5% RH in EtO)
Resolution: 0.01% RH

Physical

Size:
 Width: 0.7 in (18mm)
 Length: 2.6 in (66mm)
Weight: 1.7 oz (48 grams)
Material: 316 stainless steel; Sapphire IR windows

Sensor Elements

Temperature: Thermistor
Humidity: Capacitive polymer

Mechanical

Calibration: Factory calibrated (NIST traceable) or RH field calibration ±3% RH accuracy
Battery Type: Lithium (field-replaceable)
Clock accuracy: 26 seconds per 24 hours
Certifications: ATEX (for intrinsic safety)

Monitoring Parameters

Memory: 8,000 time/temperature observations and 8,000 time/humidity observations
Sample rates: Operator programmable 1 sec. to 1 hr. intervals

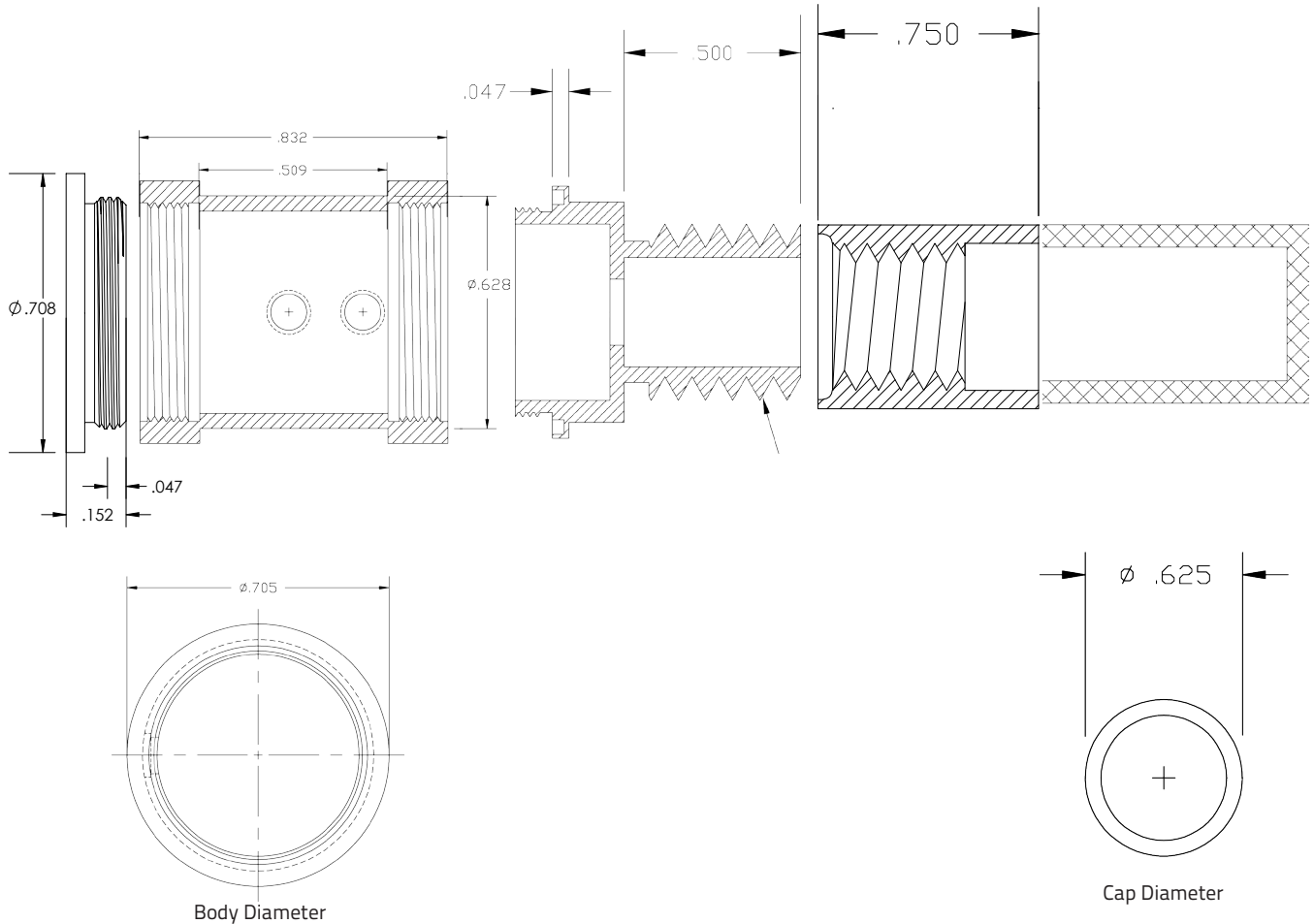

All specifications subject to change without notice. DataTrace is a registered trademark and Micropack III is a trademark of Mesa Laboratories, Inc. All other trademarks and registered trademarks are the sole property of their respective owners.

© Copyright 2015 Mesa Laboratories, Inc.

CE  21 CFR Part 11 Compliant

MPIII Pressure Data Logger

DataTrace[®] MPIII Micropack III Pressure Data Logger

Part of DataTrace's comprehensive solution, the wireless MPIII Pressure Data Logger requires minimal training to use. Features like IR communication and batch programming in just seconds make setup fast and simple. And it can collect up to 16,000 data points – 8,000 each for pressure and temperature readings - allowing for exceptional detail.

- 10 Point Pressure NIST Traceable Calibration
- 14 Point Temp NIST Traceable Calibration
- Compact Size (1.9" x 0.7")
- FDA 21 CFR Part 11 Compliant Software



MPIII Pressure Data
Logger

Exceptional performance under pressure

With a body measuring just 1.9 inches long, MPIII Pressure Data Loggers fit inside containers to get pressure readings from 0 PSIA (0 BAR) to 72.5 PSIA (5 BAR) with exceptional accuracy of ± 0.45 PSIA (± 0.03 BAR) at temperatures ranging from 25°C (77°F) to 140°C (284°F). With their wide range and high precision, MPIII Pressure Data Loggers are not only well suited to canning and pouch processes, but an array of applications where pressure affects products and quality.

- Foods, canning and newer cooking pouches
- Beverages, including wine and soda production
- Pharmaceuticals, including autoclaves and EtO sterilization
- Monitoring and testing compressed gas systems
- Pressurized process reactors and streams

DT Pro Software

DataTrace's highly secure, FDA 21 CFR Part 11 compliant DT Pro software offers reports in any format you require. Password protected access, electronic signatures and automatic documentation for audit trails streamline your work. You can even synchronize multiple loggers (in any combination of logger types) to the same clock; something disparate systems can't do.

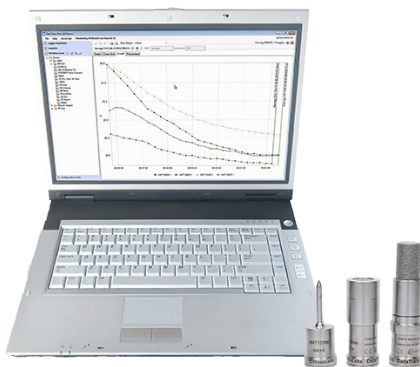

- Customize reports
- Password protected access
- Electronic signatures
- Automatic documentation

Product Specifications

Range

Operating Temperature: +25°C to +140°C (+77°F to +284°F)
Temperature Accuracy: ± 0.25°C (± 0.45°F)
Resolution: 0.001 PSI
Operating Pressure: 0 PSIA (0 BAR) to 72.5 PSIA (5 BAR)
Pressure Accuracy: ± 0.45 PSIA (± 0.03 BAR)

Physical

Size:
 Width: 0.7 in (18mm)
 Length: 1.9 in (48mm)
Weight: 1.9 oz (55 grams)
Material: 316 stainless steel; Sapphire IR windows

Sensor Elements

Temperature: Thermistor
Pressure: Strain gauge bridge

Mechanical

Media: Compatible with air and fluids, including many corrosive liquids
Calibration: Factory calibrated (NIST traceable)
Battery Type: Lithium (field-replaceable)
Clock accuracy: 26 seconds per 24 hours
Certifications: ATEX (for intrinsic safety) - under review - to be certified soon

Monitoring Parameters

Memory: 8,000 time/temperature observations and 8,000 time/pressure observations
Sample rates: Operator programmable 1 sec. to 1 hr. intervals

MPIII Pressure Logger

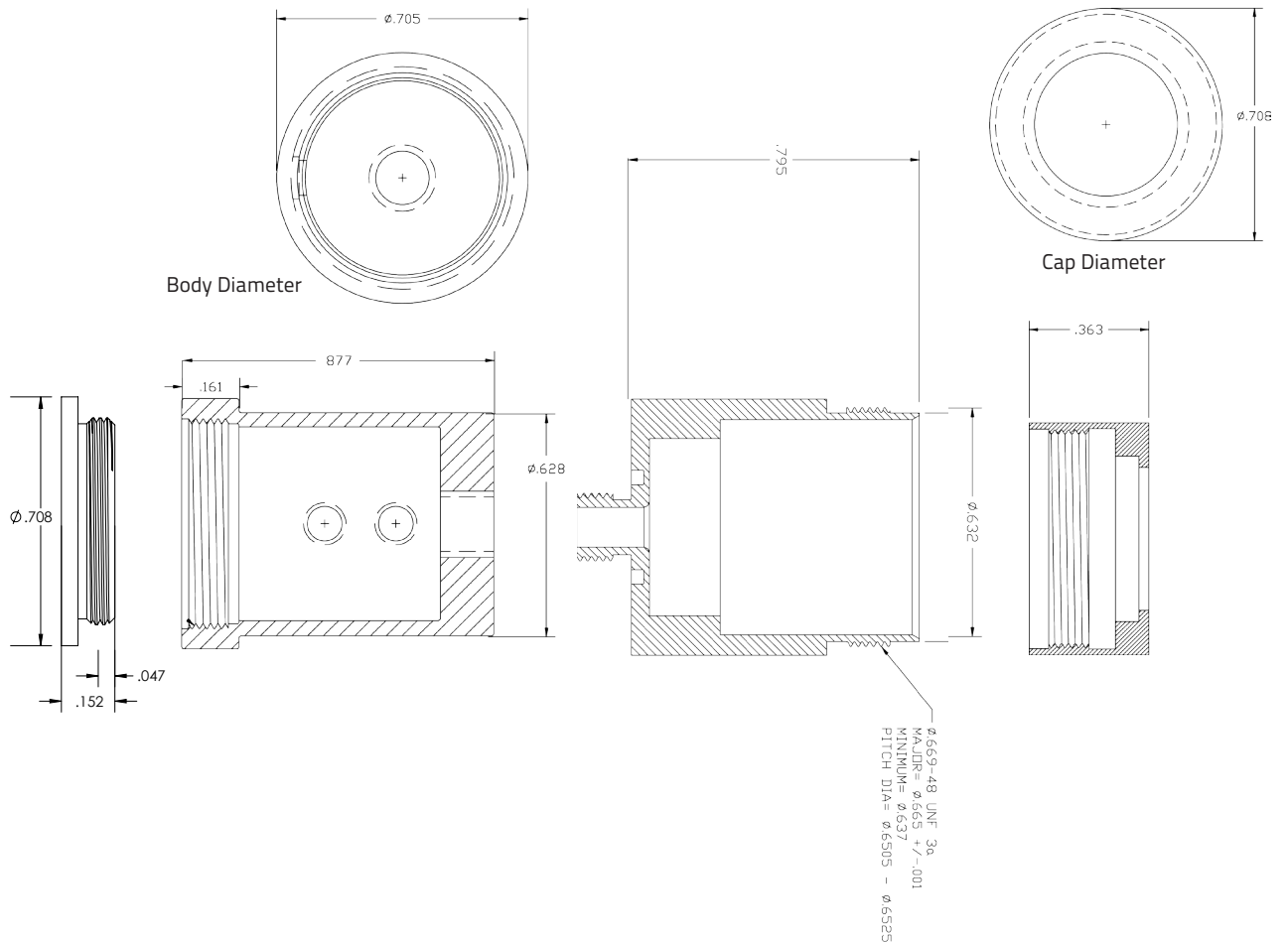

All specifications subject to change without notice. DataTrace is a registered trademark and Micropack III is a trademark of Mesa Laboratories, Inc. All other trademarks and registered trademarks are the sole property of their respective owners.

© Copyright 2015 Mesa Laboratories, Inc.



21 CFR Part 11 Compliant

MPRF Temperature Data Logger

DataTrace[®] RF

Micropack Radio Frequency Temperature Data Logger

Adaptable to almost any situation, the MPRF Temperature data logger's small size increases versatility and precision by allowing you to position the data logger very near or inside your target products.

- Wireless Temperature Data Loggers
- 10 Point Temp NIST Traceable Calibration
- Real-Time Data
- FDA 21 CFR Part 11 compliant software



Ensure precise monitoring across broad temperature changes within various industries and applications such as:

- Smokehouses
- Pasteurizers
- Lyophilizers
- Sterilizers
- Freezers
- Incubators
- Autoclaves
- Cooking and drying tunnels



MPRF Temperature Data Logger



DT Pro Software

DataTrace RF's highly secure, FDA 21 CFR Part 11 compliant DT Pro software offers reports in any format you require. Password protected access, electronic signatures and automatic documentation for audit trails streamline your work. You can even synchronize multiple MPRF Loggers (in any combination of logger types) to the same clock; something disparate systems can't do.

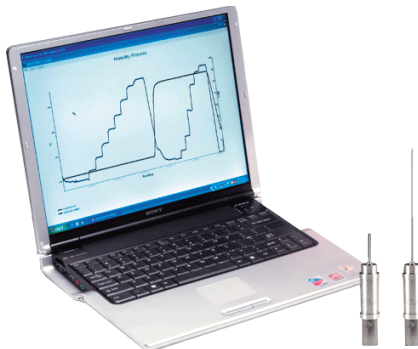

- View real-time data collection
- Customize reports
- Automatically download data and create graphs
- Password protected access
- Electronic signatures
- Automatic documentation

Product Specifications

Operating Temperature:

-80°C to +140°C (-112°F to +284°F)*

HiTemp***: +100°C (+212°F) to +360°C (+680°F) w/Thermal Pack

HiTemp EXT***: -40°C (-40°F) to +400°C (+752°F) w/Thermal Pack

Temperature Accuracy:

-80°C to -40°C (-112°F to -40°F): ±0.3°C (±0.5°F)

-40°C to +140°C (-40°F to +284°F): ±0.1°C (±0.2°F)

Resolution: 0.001°C

Operating Pressure: Up to 10 BAR

Wireless Range: 100 feet (30 meters) Line of Sight

Radio Frequency: 2.4 GHz ISM Band

Physical

Size:

Width: 0.91 in (23.2mm)

Length: 3.7 in (94mm)**

Weight: 2.3 oz (66 grams)**

Material: 316 stainless steel and ULTEM

Probe Diameter:

Rigid probe diameter: 0.125"/3.2mm or .188" (4.76mm) available

Bendable probe diameter: 0.079"/2mm

Sensor Elements

Temperature: PT1000 Class A RTD

Mechanical

Calibration: Factory calibrated (NIST traceable) or Field Calibration

Battery Type: AA Lithium (field-replaceable)

Battery Life: 6 months to 1 year (depending on usage)

Battery Weight:

Standard Temperature Battery: 0.6 oz (17 grams)

Low Temperature Battery: 0.67 oz (19 grams)

Clock accuracy: 10 seconds per 24 hours (25°C)

Certifications:

ATEX (for intrinsic safety)

FCC Class B digital device (part 15 compliant)

Monitoring Parameters

Memory:

8,192 time/temperature observations or 16,384 observations in compressed data mode.

Sample rates:

Operator programmable

- 5 sec. to 1 hr interval with radio
- 1 sec. to 1 hr interval without radio

*Operation below -40°C requires a special calibration and battery.

**Body only.

***Thermal Packs required above +140°C

All specifications subject to change without notice. DataTrace is a registered trademark and Micropack RF is a trademark of Mesa Laboratories, Inc. All other trademarks and registered trademarks are the sole property of their respective owners.

© Copyright 2015 Mesa Laboratories, Inc.



21 CFR Part 11 Compliant

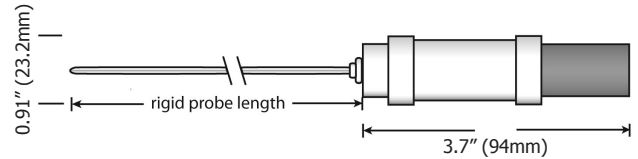

Probes available in the following lengths:

Rigid: 2" (51 mm), 3" (76 mm), 4" (102 mm), 5" (127 mm), 6" (152 mm)

Rigid probe diameter: 0.125"/3.2mm or .188" (4.76mm) available

Bendable: 10" (254 mm), 14" (355.6 mm), 25" (635 mm)

Bendable probe diameter: 0.079"/2mm

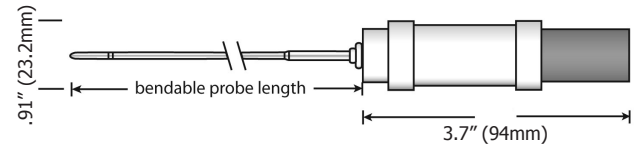

Complete Monitoring System

All MPRF Loggers require an Interface/Host System, which includes robust DT Pro software, an interface/host module and cable.

DT Pro software operates with any combination and number (up to 250) of DataTrace Temperature, Humidity and Pressure Loggers. So instead of dealing with the expense and confusion of disparate monitoring systems, users can validate, monitor, log and analyze data for multiple process parameters using a single integrated, powerful and complete solution.

MPRF Humidity Data Logger

DataTrace® RF Micropack Radio Frequency Humidity Data Logger

For processes that are sensitive to humidity, even small changes can dramatically affect product production, storage and shipping. To achieve optimal conditions, you need precise humidity data. With the MPRF Humidity Data Logger, you get it.

- Real-Time Data
- 18 Point Humidity NIST Traceable Calibration
- 10 Point Temp NIST Traceable Calibration
- FDA 21 CFR Part 11 Compliant Software
- Intrinsically Safe



MPRF Humidity Data Logger

The MPRF Humidity Data Logger provides accurate data to help you optimize food, pharmaceutical and other manufacturing processes. The closer the sensor is to the product, and the sooner you can view the collected data, the more valuable the data is. Depending on the application, the sensors can be mounted internally or externally. Our wireless data logger easily fits inside a variety of packages to maximize accuracy and process validation. And since it is wireless and operates at low voltage, it is intrinsically safe for hazardous environments.

Smaller is better, and more accurate

Rather than mounting externally like most loggers, our wireless data logger easily fits inside a variety of packages, like an ethylene oxide ER pack during sterilization, to maximize accuracy. Memory for up to 8,000 data points – 4,000 each for humidity and temperature readings – provides exceptional detail even for longer processes. And since it is wireless and operates at low voltage, it is intrinsically safe in hazardous environments.

DT Pro Software

Part of a total solution, the MPRF Humidity Logger works with DataTrace RF's, highly secure, FDA 21 CFR Part 11 compliant DT Pro software. No system gives you more flexibility. For example, you can synchronize multiple loggers (in any combination of types) to one clock.

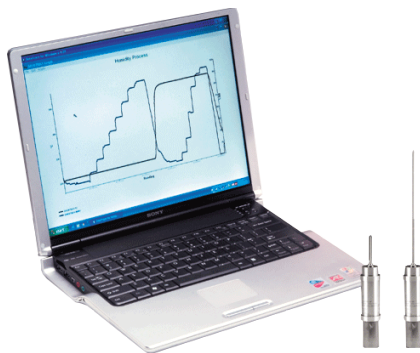

- View real-time data collection
- Customize reports
- Automatically download data and create graphs
- Password protected access
- Electronic signatures
- Automatic documentation

Product Specifications

Operating Temperature:

0°C to +85°C (32°F to +185°F)

Temperature Accuracy:

± 0.1°C (±.2°F)

Operating Humidity:

0% to 100% RH (non-condensing)

Humidity Accuracy:

±2% RH non-condensing

(±5% RH in EtO)

Resolution:

0.01% RH

Wireless Range:

100 feet (30 meters) Line of Sight

Radio Frequency:

2.4 GHz ISM Band

Physical

Size:

Width: 0.91 in (23.2mm)

Length: 5.7 in (142.5mm)

Weight:

4.0 oz (114 grams)

Material:

316 stainless steel and ULTEM

Sensor Elements

Temperature:

Thermistor

RH:

Capacitive Polymer

Mechanical

Calibration:

Factory calibrated (NIST traceable) or Field Calibration

Battery Type:

1/2 AA or Full AA Lithium (field-replaceable)

Battery Life:

6 months to 1 year (depending on usage)

Battery Weight:

0.6 oz (17 grams)

Clock accuracy:

10 seconds per 24 hours (25°C)

Certifications:

ATEX (for intrinsic safety)

FCC Class B digital device (part 15 compliant)

Monitoring Parameters

Memory:

4,096 time/temperature/humidity observations and 8,192 in compressed data mode

Sample rates:

Operator programmable

- 5 sec. to 1 hr interval with radio
- 1 sec. to 1 hr interval without radio

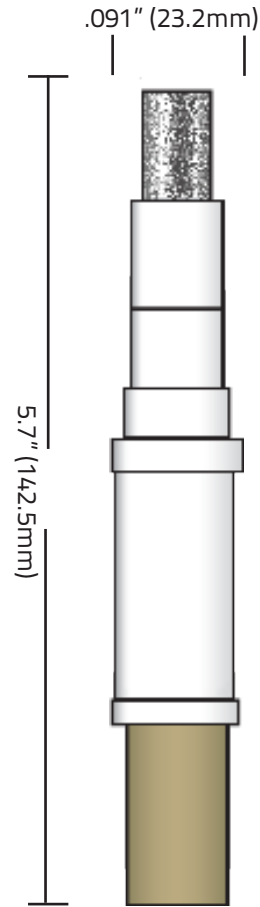

Complete Monitoring System

All MPRF Loggers require an Interface/Host System, which includes robust DT Pro software, an interface/host module and cable.

DT Pro software operates with any combination and number (up to 250) of DataTrace Temperature, Humidity and Pressure Loggers. So instead of dealing with the expense and confusion of disparate monitoring systems, users can validate, monitor, log and analyze data for multiple process parameters using a single integrated, powerful and complete solution.

All specifications subject to change without notice. DataTrace is a registered trademark and Micropack RF is a trademark of Mesa Laboratories, Inc. All other trademarks and registered trademarks are the sole property of their respective owners.

© Copyright 2015 Mesa Laboratories, Inc.



21 CFR Part 11 Compliant

MPRF Pressure Data Logger

DataTrace® RF

Micropack Radio Frequency Pressure Data Logger

The MPRF Pressure Data Logger requires minimal training and features batch programming for fast and simple set up. It captures precise detail by collecting 8,000 data points - 4,000 each for pressure and temperature readings - and can be synchronized to the same clock with multiple MPRF loggers in any combination of logger type.

- Real-Time Data
- 10 Point Pressure NIST Traceable Calibration
- 9 Point Temp NIST Traceable Calibration
- Compact Size (4.6" x 0.9")
- Intrinsically Safe



MPRF Pressure Data Logger

Ensure precise monitoring across pressure changes within various industries and applications such as:

- Foods, canning and newer cooking pouches
- Beverages, including wine and soda production
- Pharmaceuticals, including autoclaves and EtO sterilization
- Monitoring and testing compressed gas systems
- Pressurized process reactors and streams

Precision under pressure

Each MPRF Pressure Data Logger can collect 8,000 data points for exceptional detail for longer processes. Collected data is visible from one of several real-time displays or logged into DataTrace RF's highly secure, FDA 21 CFR Part 11 compliant DT Pro software and reported in any format you require. Password protected access, electronic signatures and automatic documentation for audit trails streamline your work.

DT Pro Software

Part of a total solution, the MPRF Humidity Logger works with DataTrace RF's, highly secure, FDA 21 CFR Part 11 compliant DT Pro software. No system gives you more flexibility. For example, you can synchronize multiple loggers (in any combination of types) to one clock.

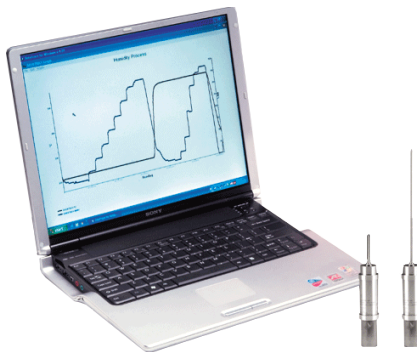

- View real-time data collection
- Customize reports
- Automatically download data and create graphs
- Password protected access
- Electronic signatures
- Automatic documentation

Product Specifications

Operating Temperature:
+25°C to +140°C (+77°F to +284°F)

Temperature Accuracy:
± 0.25°C (± 0.45°F)

Resolution:
0.001 PSI

Operating Pressure:
0 PSIA (0 BAR) to 72.5 PSIA (5 BAR)

Pressure Accuracy:
± 0.3 PSIA (± 0.02 BAR)

Wireless Range:
100 feet (30 meters) Line of Sight

Radio Frequency:
2.4 GHz ISM Band

Physical

Size:
Width: 0.91 in (23.2mm)
Length: 4.62 in (116mm)

Weight:
3.6 oz (103 grams)

Material:
316 stainless steel and ULTEM

Sensor Elements

Temperature: RTD
Pressure: Strain gauge bridge

Mechanical

Calibration:
Factory calibrated (NIST traceable)

Battery Type:
Lithium (field-replaceable)

Battery Life:
6 months to 1 year depending on usage

Battery Weight:
0.6 oz (17 grams)

Clock accuracy:
26 seconds per 24 hours

Certifications:
ATEX (for intrinsic safety)
FCC Class B digital device (part 15 compliant)

Monitoring Parameters

Memory:
4,096 time/temperature/pressure observations and 8,192 in compressed data mode

Sample rates:
Operator programmable

- 5 sec. to 1 hr interval with radio
- 1 sec. to 1 hr interval without radio

All specifications subject to change without notice. DataTrace is a registered trademark and Micropack RF is a trademark of Mesa Laboratories, Inc. All other trademarks and registered trademarks are the sole property of their respective owners.

© Copyright 2015 Mesa Laboratories, Inc.



21 CFR Part 11 Compliant

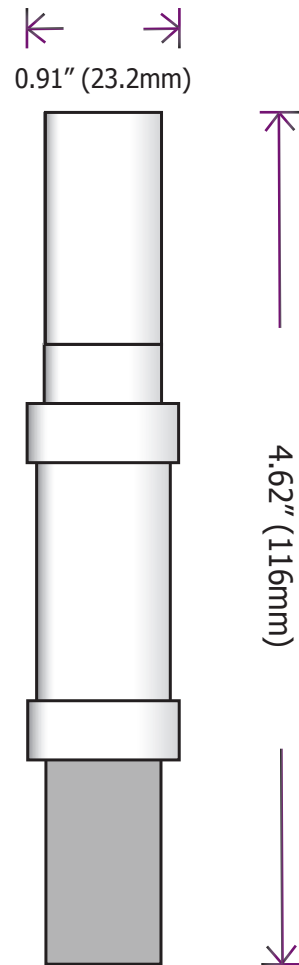

Complete Monitoring System

All MPRF Loggers require an Interface/Host System, which includes robust DT Pro software, an interface/host module and cable.

DT Pro software operates with any combination and number (up to 250) of DataTrace Temperature, Humidity and Pressure Loggers. So instead of dealing with the expense and confusion of disparate monitoring systems, users can validate, monitor, log and analyze data for multiple process parameters using a single integrated, powerful and complete solution.

PC Interface

DataTrace MPIII/MPRF PC Interface

The DataTrace PC Interface is an integral part of the DataTrace data logger system. Mesa's USB compatible PC interface rapidly communicates with your data loggers using wireless infrared (IR) technology. Communication takes only seconds, and using wireless 2.4GHz technology, the MPRF interface is also capable of communicating with large groups of MPRF data loggers in real-time, connecting DataTrace data loggers with Mesa's powerful DT Pro software.



MPIII

Specifications:

Height:	1.44"
Length:	4.30"
Width:	2.75"

Specifications:

Height:	1.44"
Length:	4.30"
Antenna Length: (MPRF)	4.42"
Width:	2.75"



MPRF