

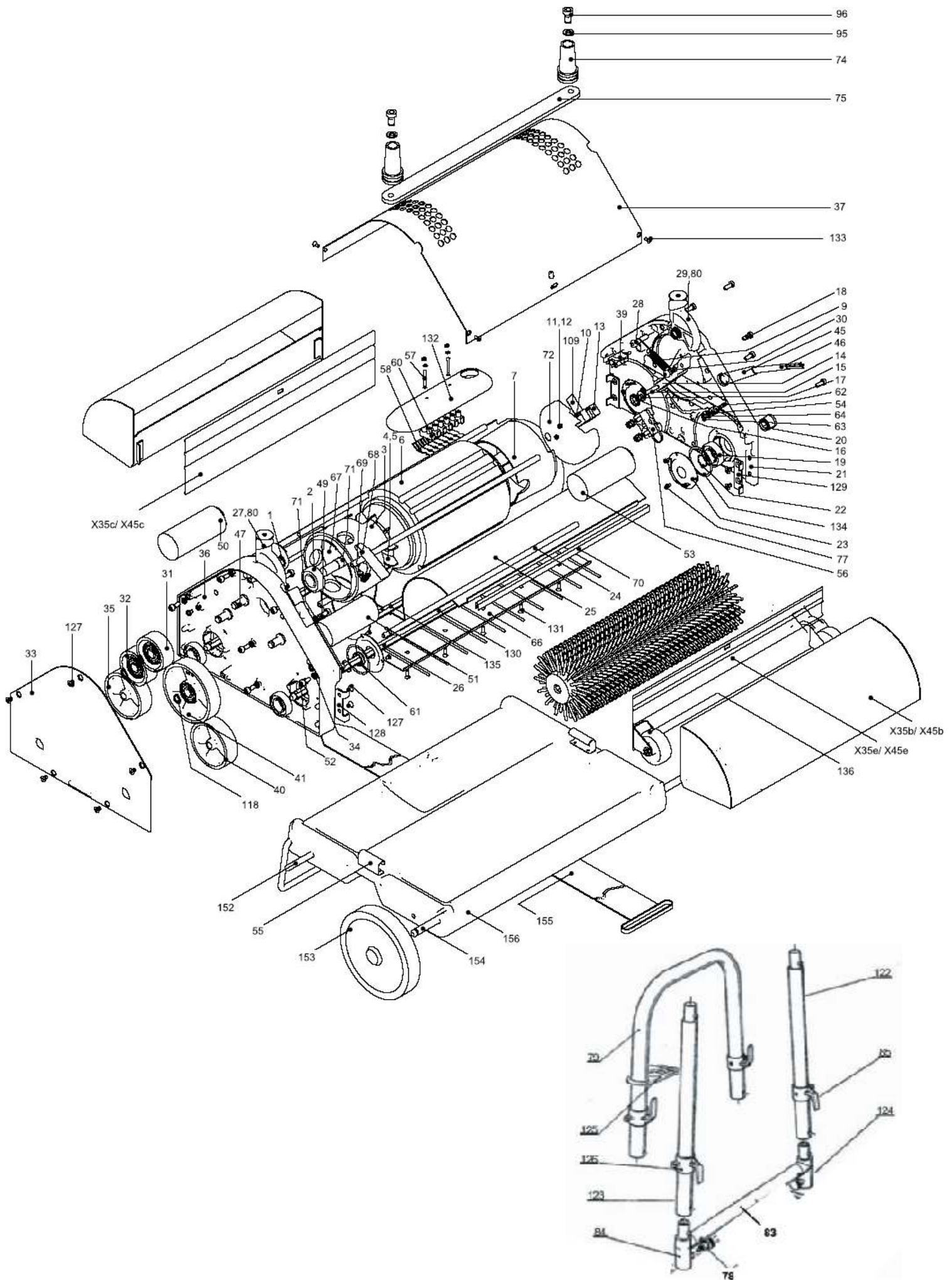







Ersatzteile / spare parts - PRO 35 / PRO 45

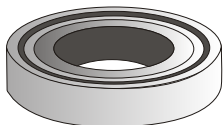
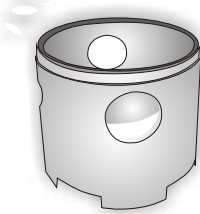
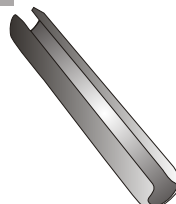
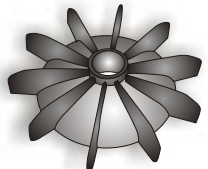
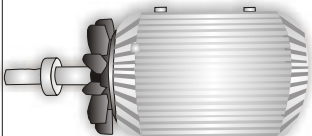
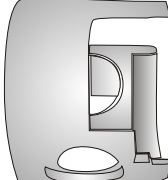

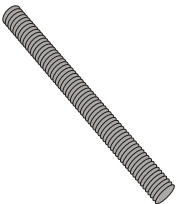

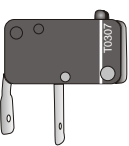
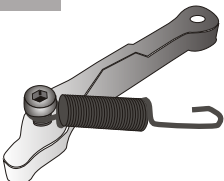
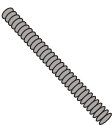

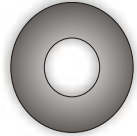
Ersatzteile - spare parts PRO 35 / 45

<p>1</p> 	<p>2</p> 	<p>3</p> 	<p>4</p> 
<p>Sicherungsring A 12 Snapring A 12</p>	<p>Rillenkugellager Ballbearing</p>	<p>Zwischenstück G Distancepiece G</p>	<p>Spannstift 3 x 20 A2 Split pin 3 x 20 A2</p>
<p>5</p> 	<p>6</p> 	<p>7</p> 	<p>9</p> 
<p>Lüfterrad Ventilator</p>	<p>Motor RBF 0,18/2-PR Motor RBF 0,18/2-PR</p>	<p>Zwischenstück E Distancepiece E</p>	<p>Zugfeder 10x 1,2 x 64 Extension spring 10x 1,2 x 64</p>
<p>10</p> 	<p>11</p> 	<p>12</p> 	<p>13</p> 
<p>Gewindestift M3 x 40 Grub screw M3 x 40</p>	<p>Mutter M3 Ms Nut M3 Ms</p>	<p>Federring M3 Spring Ring M3</p>	<p>Microschalter Microswitch</p>
<p>14</p> 	<p>15</p> 	<p>16</p> 	<p>17</p> 
<p>Schaltteil kpl. Switchpart cpl.</p>	<p>Gewindestift M5x 25 Grub screw M5 x 25</p>	<p>Sechskantmutter M5 Nut M5</p>	<p>Scheibe M5 Disc M5</p>

Ersatzteile - spare parts PRO 35 / 45

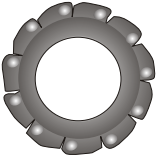
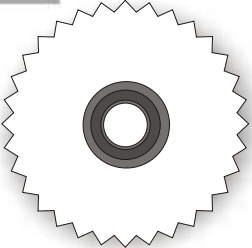
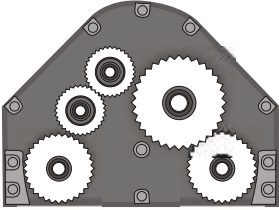
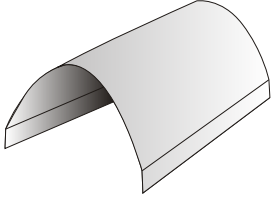
<p>18</p> 	<p>19</p> 	<p>20</p> 	<p>21</p> 
<p>Zylinderschraube M5 x 12 Cylinder head screw M5 x 12</p>	<p>Rillenkugellager Ballbearing</p>	<p>Flansch Flange</p>	<p>Gehäuseblock E komplett Housing unit E complet</p>
<p>22</p> 	<p>23</p> 	<p>24</p> 	<p>25</p> 
<p>Sicherungsring 16 x 1 Snapring 16 x 1</p>	<p>Fadenschutz Protective plat</p>	<p>Zugstange Motorstud</p>	<p>Bürstabdeckung Brushcover</p>
<p>26</p> 	<p>27</p> 	<p>28</p> 	<p>29</p> 
<p>Steckachse Brush axle</p>	<p>Stielansatz Unterteil G Handle connector lower part G</p>	<p>Zylinderschraube M6 x 16 Cylinder head screw M6 x 16</p>	<p>Stielansatz Unterteil E Handle connector lower part E</p>
<p>30</p> 	<p>31</p> 	<p>32</p> 	<p>33</p> 
<p>Zylinderschraube M6 x 16 Cylinder head screw M6 x 16</p>	<p>Zahnrad 48 rechts Gear 48 right</p>	<p>Zahnrad 48 links Gear 48 left</p>	<p>Getriebedeckel Gearcover</p>

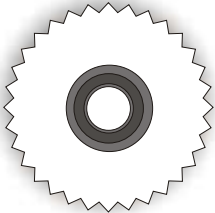
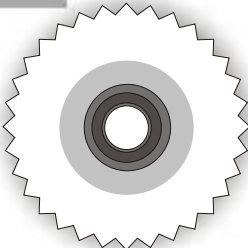
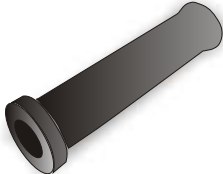
Ersatzteile - spare parts PRO 35 / 45

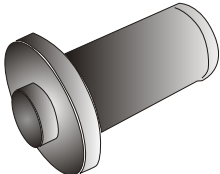
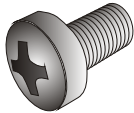
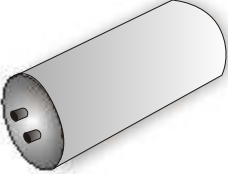
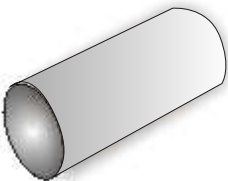
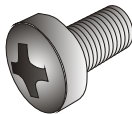
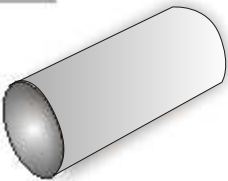
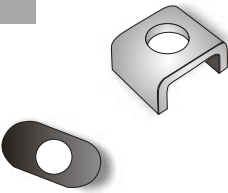
<p>34</p> 	<p>35</p> 	<p>36</p> 	<p>37</p> 
<p>Zahnscheibe M5 Lock washer M5</p>	<p>Zahnrad 66 rechts Gear 66 right</p>	<p>Gehäuseblock G komplett Housing unit G cpl.</p>	<p>Motorhaube motor cover</p>
<p>39</p> 	<p>40</p> 	<p>41</p> 	<p>45</p> 
<p>Motorschutzschalter Thermorelay</p>	<p>Zahnrad 66 links Gear 66 left</p>	<p>Zahnrad 73 rechts Gear 73 right</p>	<p>Tülle Grommet</p>
<p>46</p> 	<p>47</p> 	<p>49</p> 	<p>50</p> 
<p>Kabel Cable</p>	<p>Lagerbolzen Bearingpin</p>	<p>Zylinderschraube M4 x 8 Cylinder head screw M4 x 8</p>	<p>Betriebskondensator Run capacitor</p>
<p>51</p> 	<p>52</p> 	<p>53</p> 	<p>54</p> 
<p>Anlaufkondensatorkondensator Starting capacitor</p>	<p>Zylinderschraube M5 x 12 Cylinder head screw M5 x 12</p>	<p>Anlaufsteuerung Starting control</p>	<p>Klemmbügel-/Schiene Clamp strip</p>

Ersatzteile - spare parts PRO 35 / 45

55

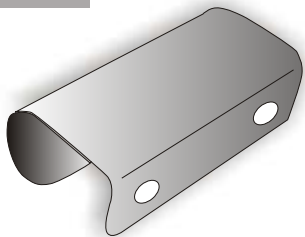

Haltefeder
Fixing spring

56

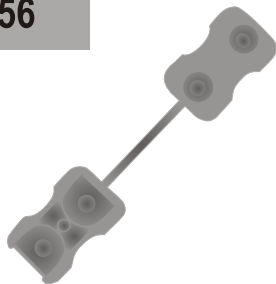

Klemmbacke
Cable clamp

57

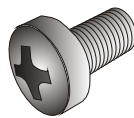

Zylinderschraube M3 x 25
Cylinder head screw M3 x 25

58

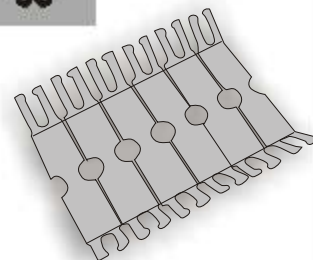

Drahthalteplatte
wire fixing plate

60

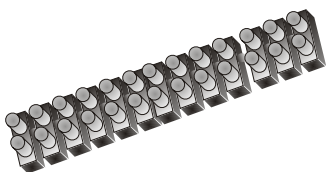

Klemmleiste
terminal

61

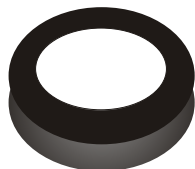

V-Ring
V-ring

62

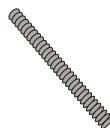

Gewindestift
Wormscrew

63



Mutter M4
Nut M4

64

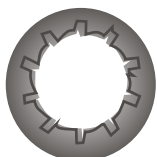

Zahnscheibe M4 A2
Lock washer M4 A2

66

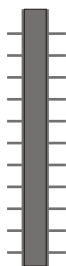

Kabelfang
Cableprotector

67

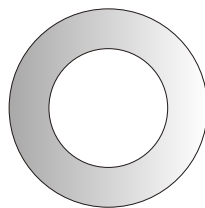

Blende
Blind

68

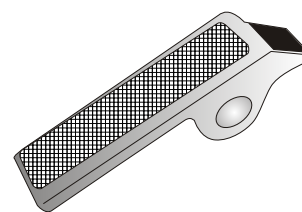

Stielsperre Alu
Handle stop

69



Feder für Stielsperre
Handle stop - spring

70



Schaumstoffdichtung
Seal (Cover)

71



Sicherungsring A 15
Snapping A 15

72

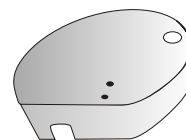

Schalterabdeckung
Switchcover

Ersatzteile - spare parts PRO 35 / 45

74

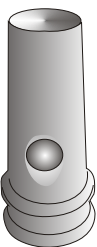

Stielansatzoberteil
Handle connector upper part

75

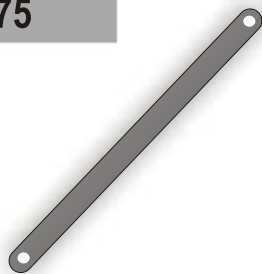

Flachstange
Flatbar

77

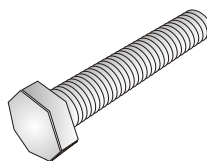

Schraube M3 x 5
Screw M3 x 5

78

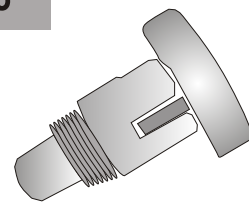

Zugschnäpper
Snap - in

79



Stiel Oberteil
Handle, upper part

83



Querrohr
Cross bar

84

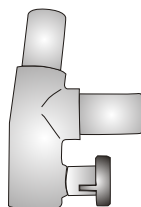

Stielknoten links
T-piece left

85

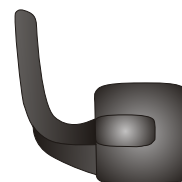

Kabelhaken links
Cable holder left

88



Stiel komplett
Handle complete

95



Federring M6
Spring Ring M6

96

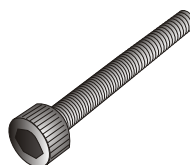

Schraube M6 x 30
Screw M6 x 30

106

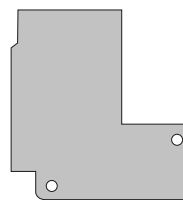

Isolierplättchen
Isolating plate

118



Sicherungsring A 12
Snarpring A 12

122

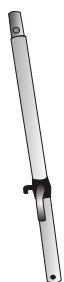

Stielunterteil links
Handle, lower part left

123



Stielunterteil rechts
Handle, lower part right

124

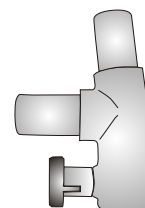

Stielknoten rechts
T-piece right

Ersatzteile - spare parts PRO 35 / 45

126

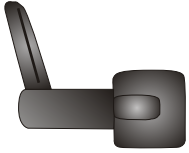

Kabelhaken rechts
Cable holder right

127



Senkkopfschraube M5 x 6
Countersunk-head screw M5 x 6

128



Halter links
Holder left

129

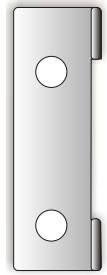

Halter rechts
Holder right

130



Einwurfbeschleuniger
Throw-in accelerator

131



Senkkopfschraube M4 x 12
Countersunk-head screw M4 x 12

132



Spritzschutz
Protective cove

133



Senkkopfschraube M4 x 8
Countersunk-head screw M4 x 8

134

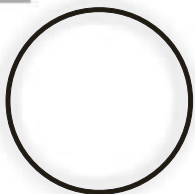

O-Ring
O-ring

135

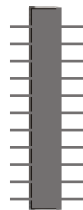

Kabelfang
Cable protector

136



Rad Schutzenblech kpl.
Wheel cover plate cpl.

152



Standbügel
Holder

153



Rad Transportwagen
Wheel Trolley

154

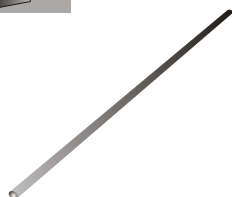

Radachse
Axel

155

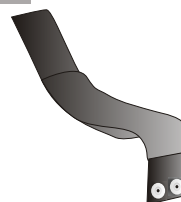

Gurt
Belt

156

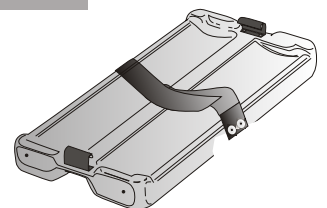

Transporttasche inkl. Haltefeder und Gurt
Tray incl. clips and belt

Ersatzteile - spare parts PRO 35 / 45

157

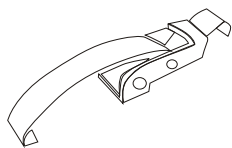

Verschluss für
Renovator und Staubschutz