

DALI Touchpanel



Datasheet
Control Module

Multifunctional DALI control module
with flexible layout

Art. Nr. 24035465

DALI Touchpanel Control Module

Overview

- Control device for DALI-systems
- 4 standard layouts for colour and colour temperature control and Switching/Dimming
- Individual layout configuration (up from firmware 4.8)
- Configuration with DALI-Cockpit software tool and DALI-USB interface
- Multimaster capable - multiple touch panels can be installed on the same DALI-line.
- Frame material in plastic
- Customized frame colours and directly printed surface for OEM
- The DALI touch panel can be mounted on a conduit box.
- The module is supplied directly via the DALI signal line

Specification, Characteristics

type	DALI Touchpanel
article number	24035465
electrical data	
supply	via DALI-line
typ. current consumption	4 mA
output	DALI
function	configurable
technical data:	
storing and transportation temperature	-20°C ...+75°C
operational ambient temperature	-20°C ...+75°C
protection class	IP20
maximum connection wire crosssection	2.5 mm ²
geometry	111mm x 83mm x 9mm
material of housing	ABS
frame colour	white, RAL 9010

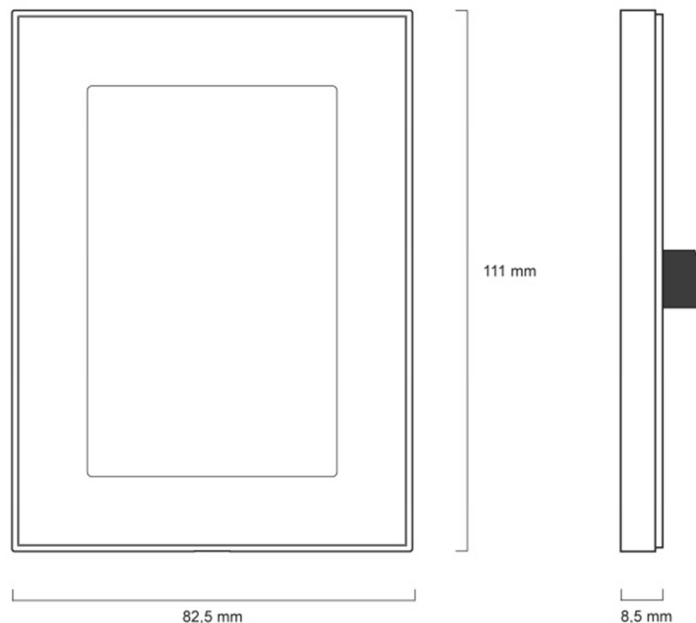

geometry

standard-layouts (designs included in delivery – customized design can be used as well):

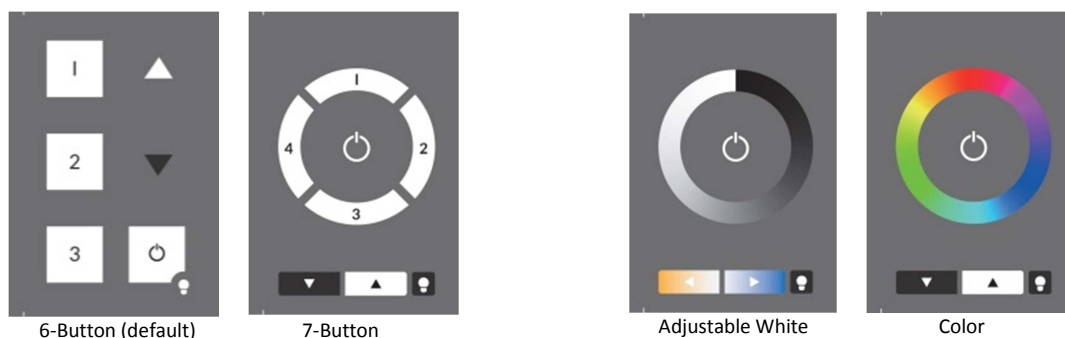

Installation

The DALI Touch is connected directly to the DALI-line. The current consumption is about 4mA. The connection to the DALI-line is polarity free.

The DALI Touch can be mounted on a installation box.

required for installation and can be removed afterwards.

During the installation process a user action is required for device identification. Please doubleclick the touchscreen on request.

Addressing and Configuration

With the help of a DALI-USB interface the DALI Touch can be configured with the DALI-Cockpit software tool. The interface is only

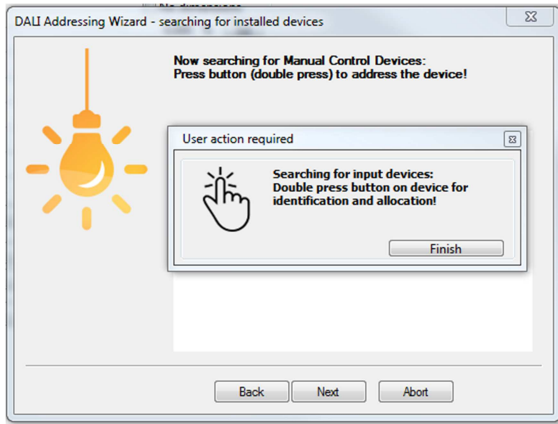

The DALI Touch will be recognized and an address will be assigned. Afterwards the device can be configured.

Configuration Site (Firmware <4.8):

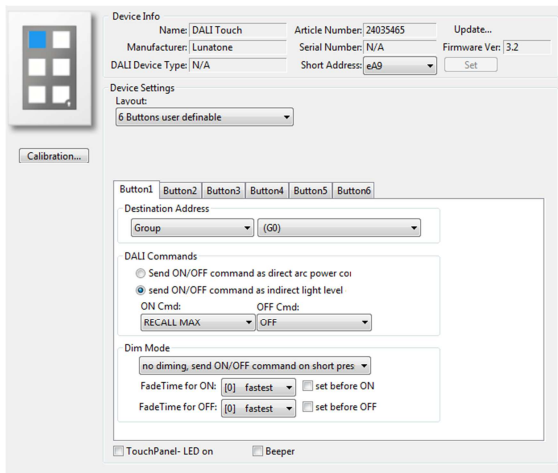

The layout can be selected in the dropdown menu. The corresponding layout card can be inserted in the panel.

Configuration Site (Firmware >=4.8):

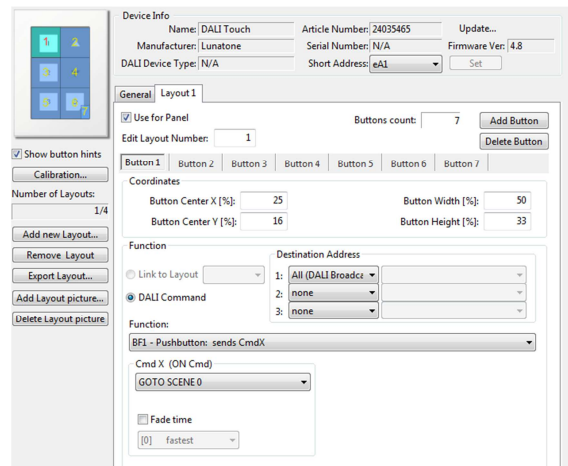

The standard layouts are still available as preset. Alternatively layouts can be generated individually by the customer, i.e, buttons can be arranged and functions can be assigned to each button. An appropriated layout card can be inserted like the standard cards..

Standard and new layouts can be selected with the „Add New Layout“ menu. Up to 4 layouts can be stored in the touchpanel. The used layout has to be activated by checking „Use For Panel“. For details please check the manual.

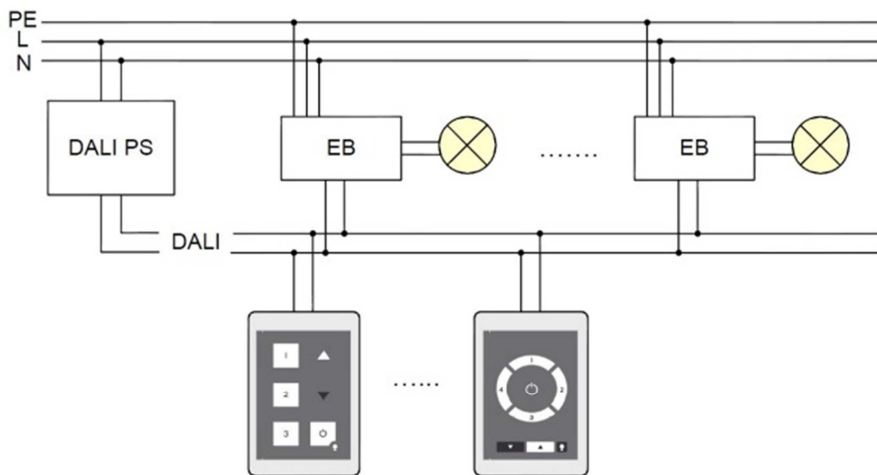

typical structure for the control of scenes and groups

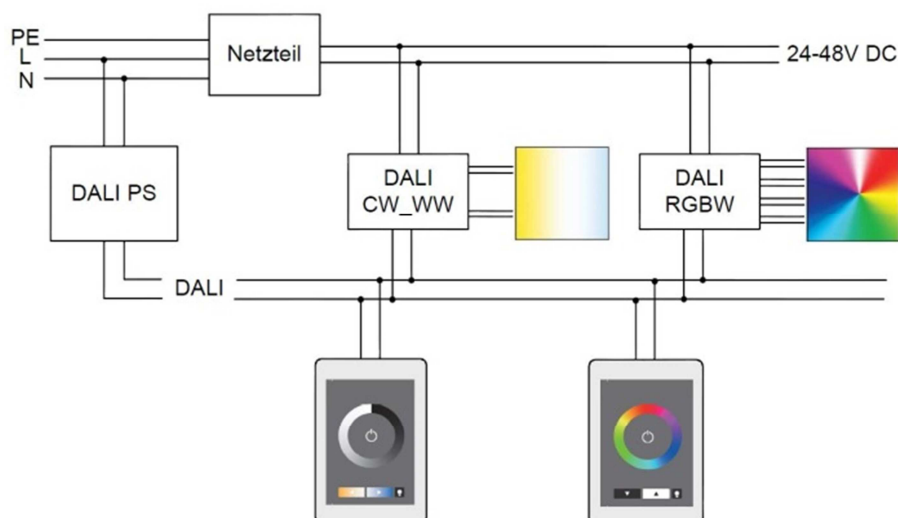

structure for the control of colour/colourtemperature

Purchase Order Information

ArtNr. 24035465: DALI Touch, input device,
ABS-frame

Additional Information and Equipment

DALI-Cockpit – free configuration tool from
Lunatone for DALI systems
<http://lunatone.at/en/downloads/Lunatone-DALI-Cockpit.zip>

Lunatone DALI products
<http://www.lunatone.at/en/>

Lunatone datasheets and manuals
<http://lunatone.at/en/downloads/>

Contact

Technical Support: support@lunatone.com

Requests: sales@lunatone.com

www.lunatone.com



Disclaimer

Subject to change. Information provided without guarantee.
The datasheet refers to the current delivery.

The function in installations with other devices must be tested
for compatibility in advance.