

1200 Lb. Magnetic Gate Lock Kit

Installation

It is essential that the surfaces of the armature and the magnetic lock seat perfectly to one another when the gate is in the closed position. This allows the lock to achieve its maximum holding strength. It is critical the armature is securely fastened to the gate frame, but able to move with the 1/8 to 1/4 inch rubber spacer(s) to correctly align with the magnetic lock.

Important: Weld the brackets to fence post and gate frame **BEFORE** assembling the armature and maglock.

Welded Mounting Brackets

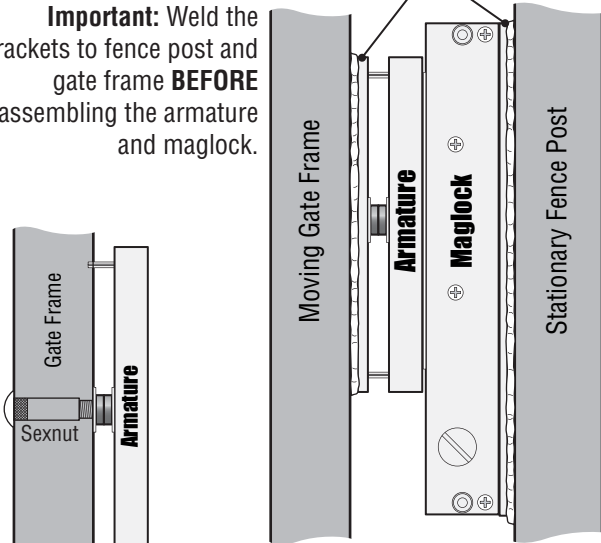

Typical Front Mount Welded

Note: Additional hardware is supplied for a side mount option and different armature spacing configurations.

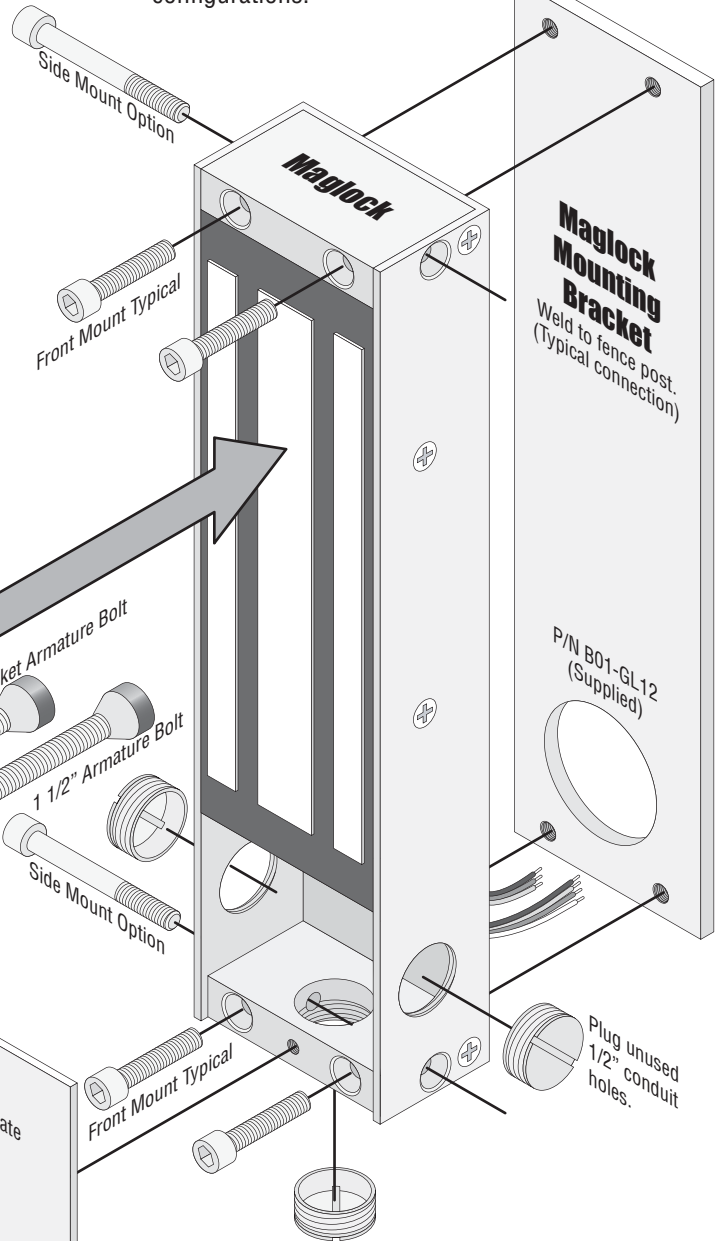

Sexnut Note: Using the sexnut, the armature can be mounted directly to the gate frame without using the supplied armature mounting bracket. Secure sexnut through the gate frame and into armature bolt.

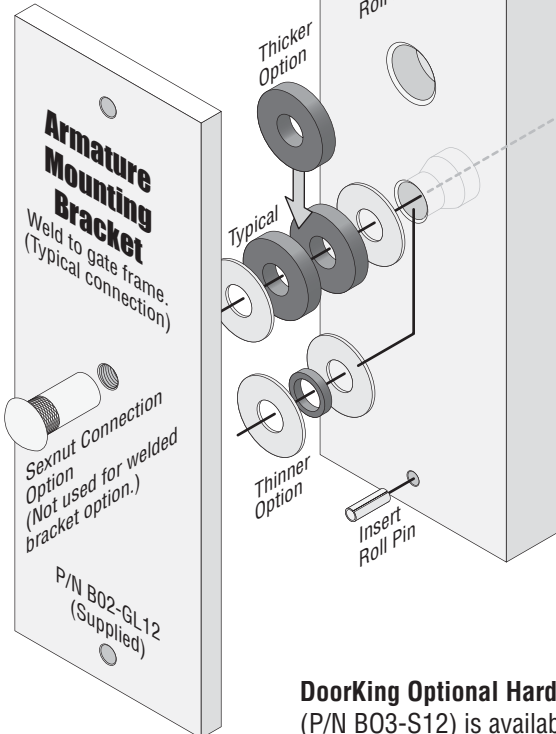

DoorKing Optional Hardware Note: "L" and "Z" bracket kit (P/N B03-S12) is available for different installation configurations.

Wire for 24 VDC or 12 VDC ONLY

DoorKing Part Numbers
1216-080
1216-081

MOV Note: Install the supplied MOV across the power supply terminals to protect the magnetic lock from transient voltage spikes.

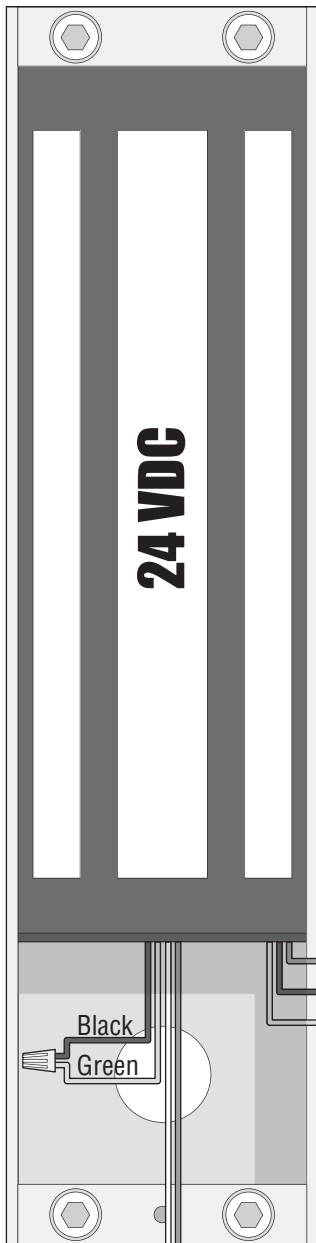

LED Lock Status Sensor Relay Contacts

Rated 1 amp @ 30 Volt max.
 (Model 1216-081 Only)

- Red - Normally Closed
- Black - Common
- Green - Normally Open

24 VDC Transformer

(Model 1812-035)

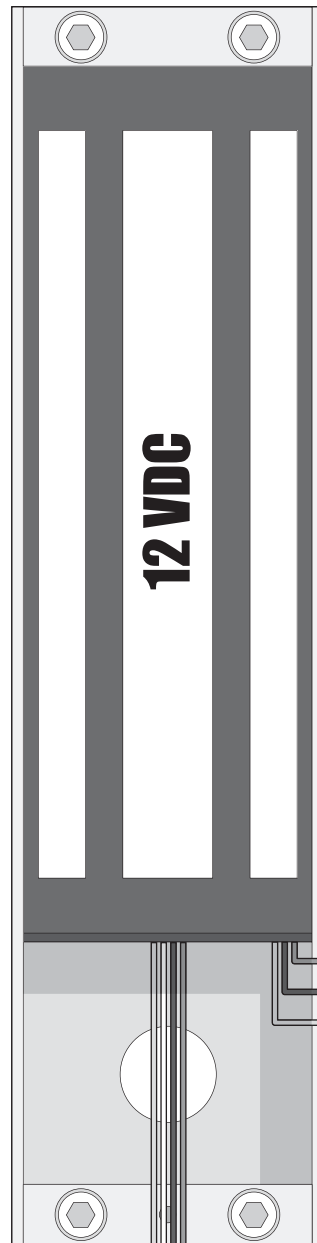
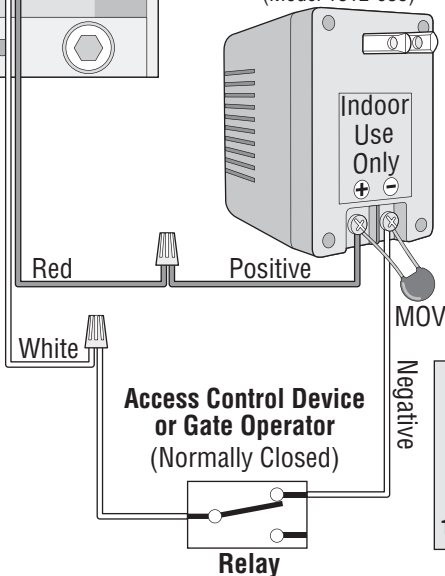

LED Lock Status Sensor Relay Contacts

Rated 1 amp @ 30 Volt max.
 (Model 1216-081 Only)

- Red - Normally Closed
- Black - Common
- Green - Normally Open

12 VDC Transformer

(Model 1812-037)

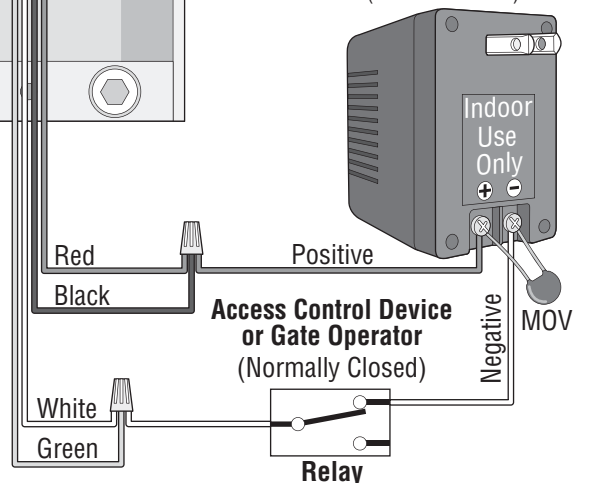

⚠ Polarity Matters!
 16 AWG - 200 Ft
 18 AWG - 100 Ft
12 or 24 VDC Wire Run

DKS™
DOOR KING®, INC.
 120 Glasgow Avenue
 Inglewood, California 90301 U.S.A.