

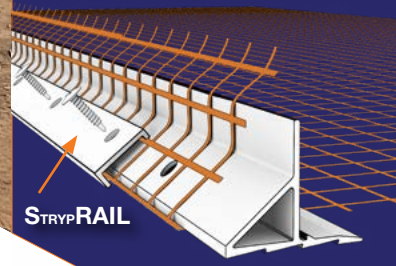

Engineered Edge Restraints

Engineered for
**PERMEABLE
& OPEN-GRADED
BASE DESIGNS**

**HEAVY
PAVER
THIN**



ENGINEERED EDGE RESTRAINTS



Fortress Edging is made of strong, durable, and environmentally responsible PVC with a controlled amount of recycled PVC material, designed and proudly manufactured in the USA.

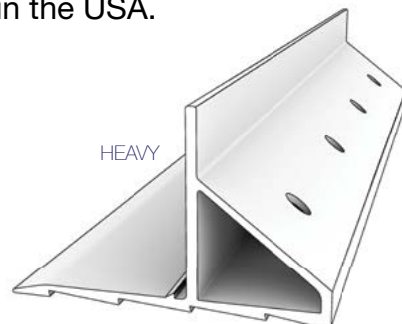

952.226.7227

FORTRESSEDGING.COM

REVOLUTIONARY FORTRESS EDGING AND STRYPRAIL

ORIGINS

The origin of FORTRESS Engineered Edge Restraints comes from Steve Jones, who in 1987, was the inventor of the original Pave Edge; the first strip plastic paver edge restraint. Pave Edge revolutionized the concept of edging/curbing for segmental paving. Pave Edge set the standard for performance with its ground breaking frost heave/sand retention lip.



STRAIGHT



- PROVEN DESIGN
- STRONGEST
- UPS SHIPPABLE
- VERSATILE
- CONTRACTOR & ARCHITECT FRIENDLY
- "GRYPPER" TECHNOLOGY
- BULLET-PROOF STRYPRAIL SYSTEM



VERSA

The properties of Fortress Versa edging help make geometrically pleasing smooth curves, for both gradual and extreme designs.



GRYPPER



DIRECTIONAL RESISTANCE

Unique to all Fortress profiles, the new patent-pending directional GRYPPEERS add additional holding power once installed, to help prevent edging from shifting over time.

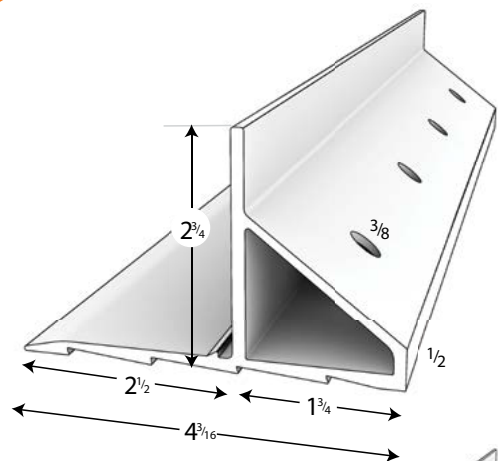

HEAVY

Commercial segmental pavers (including permeable), large natural stone sets, and projects using open-graded aggregates

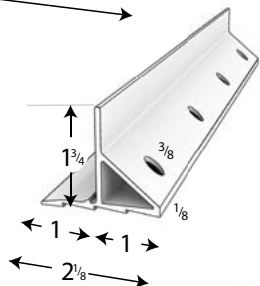

PAVER

For standard hardscape paving, including 5-7 cm concrete, clay and stone

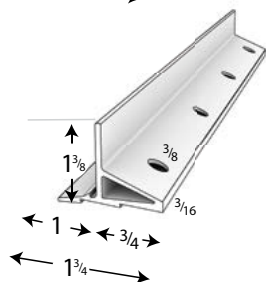

THIN

For porcelain, natural stone tiles, wet cast slabs and pavement overlays

If you're going to insure quality and longevity in your workmanship, you absolutely should be using Fortress Edging.

Joel Hedrick, Meadowood Inc. 40 years hardscape experience

STRYPRAIL®

Geo-Tension Edge Restraint Anchor

Geo-Tension Edge Restraint Anchor

STANDARD
for PAVER and THIN profiles

HEAVY
for HEAVY profiles

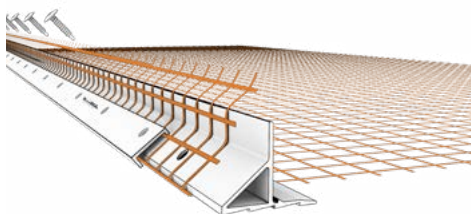

STRYPRAIL (Geo-Tension Edge Restraint Anchor) was designed to deal with the difficulty of providing a proper edge restraint when using OGA (Open-Graded Aggregate) base and to increase the holding ability and longevity for all paver pavements including standard compacted DGA (Dense Graded Aggregate) installations.

The goal was to develop a superior hold for Fortress paver edge restraints with any base application, as well as extend the life and performance of the edge restraint and pavement.

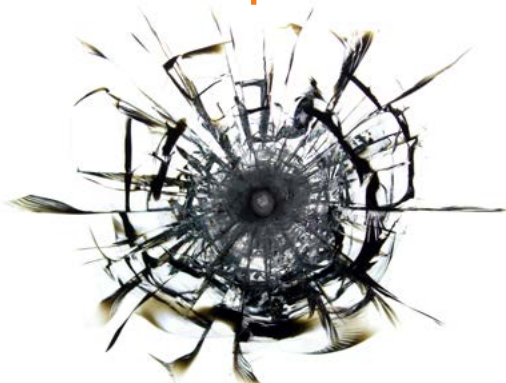

Make your installation **BULLET-PROOF** with StrypRail and Fortress Edge





The Leader in Hardscape Pavement Edge Restraints



Specs

SKU	Description	Dimensions	Weight
481408	THIN Straight 7ft 1pc	1.75" W x 1.375" H x 84" L	1.85 lb
481409	THIN Straight 1 Bundle 84ft 12pc	4.75" W x 3.25" H x 84" L	22 lb
481412	THIN Versa 7ft 1pc	1.75" W x 1.375" H x 84" L	1.6 lb
481413	THIN Versa 1 Bundle 84ft 12pc	4.75" W x 3.25" H x 84" L	19 lb
481400	PAVER Straight 7ft 1pc	2.00" W x 1.75" H x 84" L	2 lb
481401	PAVER Straight Bundle 84ft 12pc	6.50" W x 3.875" H x 84" L	24 lb
481404	PAVER Versa 7ft 1pc	2.00" W x 1.75" H x 84" L	1.85 lb
481405	PAVER Versa Bundle 84ft 12pc	6.50" W x 3.875" H x 84" L	22 lb
481421	HEAVY Straight 7ft 1pc	4.25" W x 2.625" H x 84" L	4.7 lb
481422	HEAVY Straight 1 Bundle 84ft 12pc	9.50" W x 7" H x 84" L	56 lb
481425	HEAVY Versa 7ft 1pc	4.25" W x 2.625" H x 84" L	3.5 lb
481426	HEAVY Versa 1 Bundle 84ft 12pc	9.50" W x 7.00" H x 84" L	42 lb

(952) 226-7226

info@fortressedging.com

FORTRESSEDGING.COM

© All rights reserved. Oct 2021 Shensi LLC