

4K WiFi WATERPROOF ACTION CAMERA

INSTRUCTION MANUAL



Introduction

Welcome to a whole new adventure!

With its waterproof casing, multiple mounting accessories, 6-axis stabilization unit and wide 170° field of view, the National Geographic 4K WiFi Waterproof Action Camera has everything you need to capture the extremes of all of your outdoor adventures in ultra-high definition.

Whether you are trail riding, kayaking, snorkeling or climbing, this versatile camera can document your experiences in a range of resolution options including 4K video up to 60 fps and 20MP photo resolution. Use the included app, for iOS and Android, for live preview, camera controls, playback and download your photos and videos directly to your phone or table. It also can be operated using a remote-control device that attaches to the user's wrist.

To ensure it is ready to go wherever the action takes you, the camera's body is IPX8 waterproof for up to 19.5 feet (6 meters) and up to 131 feet (40 meters) when inside the waterproof case. It comes with a variety of accessories to accommodate multiple mounting needs and a 6-axis gyro unit that provides excellent stabilization during fast-paced activities.

To discover more about the features of the National Geographic 4K WiFi Waterproof Action Camera and how to use them, please read this manual thoroughly.

Table of Contents

P. 04	: About this Manual and General Warnings
P. 08	: What's Included
P. 10	: Meet the 4K Camera / Parts Diagrams
P. 12	: Camera Functions
P. 14	: Camera Setup
P. 17	: Remote Control
P. 18	: Overview of Modes
P. 20	: Using the Camera - Video Mode
P. 24	: Using the Camera - Photo Mode
P. 28	: Using the WiFi App
P. 30	: Media Playback
P. 32	: System Settings
P. 35	: Charging the Battery
P. 37	: Waterproof
P. 38	: Underwater Usage
P. 39	: Mounting the Camera
P. 40	: Video Specifications
P. 41	: Photo Specifications
P. 42	: Camera Specifications

About this Instruction Manual



Please read the safety instructions and the operating instructions carefully before use. Keep these instructions for renewed use at a later date. When the device is sold or given to someone else, the instruction manual must be provided to the new owner/user of the product.

Read these safety instructions before using your device and store them for possible future reference. This product is intended only for private use. It was developed as an electronic medium for the use of multimedia services.

Important Safety Instructions

- 1) Read these instructions.
- 2) Keep these instructions.
- 3) Heed all warnings.
- 4) Follow all instructions.
- 5) Store the device in cool, dry and dust-proof places.
- 6) The camera's body is designed to be waterproof to 15 feet. However, all doors must be secured to avoid any damages. Do not use this camera in water deeper than 15 feet (4.5 meters) unless it is securely enclosed in the waterproof housing.
- 7) Clean only with dry cloth.
- 8) Never touch the lens surface with your fingers.
- 9) Do not block any ventilation openings. Install in accordance with the manufacturer's instructions.
- 10) Never point the camera lens directly at the Sun. Doing so may damage the image sensor.
- 11) Do not place or store the device near any heat sources such as radiators, heat registers, stoves, or other apparatuses (including amplifiers) that produce heat.
- 12) Do not defeat the safety purpose of the polarized or grounding-type plug. A polarized plug has two blades with one wider than the other. A grounding type plug has two blades and a third grounding prong. The wide blade or the third prong are provided for your safety. If the provided plug does not fit into your outlet, consult an electrician for replacement of the obsolete outlet.
- 13) The charging cord should always be readily accessible.
- 14) While it is charging, keep the product and the power cord out of the reach of children to prevent accidental suffocation or electric shock.
- 15) Protect the power cord from being walked on or pinched particularly at plugs, convenience receptacles, and the point where they exit from the apparatus.
- 16) In case of overheating, smoke, or unpleasant smell in the process of charging, unplug your device immediately to prevent a fire.
- 17) If the charging cord is damaged, have it repaired by the manufacturer, its service or a similarly qualified person in order to avoid any hazard.
- 18) Replacing the battery incorrectly or with a battery that is not the same type or its equivalent could result in an explosion.
- 19) The battery should not be exposed to excessive heat such as sunlight, fire or any heat sources such as radiators, heat registers, stoves, or other apparatuses (including amplifiers) that produce heat.
- 20) The battery must be installed according to the polarity.
- 21) The battery must be disposed of safely. Always use the collection bins provided (check with your dealer) to protect the environment.

- 22) Non-rechargeable batteries are not to be recharged.
- 23) Rechargeable batteries must be removed from the unit before being charged, and should only be charged under adult supervision.
- 24) Do not short-circuit the supply terminals.
- 25) Only use attachments/accessories specified by the manufacturer or sold with the apparatus. When a cart is used, use caution when moving the cart/apparatus combination to avoid injury from tip-over.
- 26) Unplug this apparatus during lightning storms or when unused for long periods of time.
- 27) Refer all servicing to qualified service personnel. Servicing is required when the apparatus has been damaged in any way, such as the power supply cord or plug is damaged, liquid has been spilled or objects have fallen into the apparatus, the waterproof seal has been compromised, it does not operate normally, or has been dropped.
- 28) Do not expose the unit to strong magnetic objects or strong radio waves. Strong magnetic fields may cause product malfunctions or damage to images and sounds.
- 29) If the unit has not been operated in a long time, check whether the camera operates normally or not before using the camera again.
- 30) Always backup or download any data from any memory card before reusing. It is recommended that you test any memory card to make sure it is properly storing the data before any imaging session.
- 31) Please choose branded Micro SD card. Neutral cards are not guaranteed to work normally.
- 32) Do not place memory card near strong magnetic objects to avoid data loss.
- 33) Do not bend the memory card and avoid dropping or stressing the card.
- 34) Keep the memory card clean and avoid touching any liquids. If the memory card gets wet, wipe it dry with a soft cloth.
- 35) When the memory card is not in use, place it in a card sleeve.
- 36) Please note it is normal that the memory card will become hot after prolonged use.
- 37) Do not use the memory card with other digital cameras. If you want to use a different memory card with your camera, format it first.

General Warnings

- **Risk of choking!** — Keep packaging material, like plastic bags and rubber bands, out of the reach of children, as these materials pose a choking hazard. This product contains small parts that could be swallowed by children.
- **Leaking battery acid can lead to chemical burns!** Avoid contact of battery acid with skin, eyes and mucous membranes. In the event of contact, rinse the affected region immediately with plenty of water and seek medical attention.
- **Risk of electric shock!** — Never bend, pinch or pull the power and connecting cables, extensions and adapters. Protect the cables from sharp edges and heat. Before operating, check the device, cables and connections for damage. Never use a damaged unit or a unit with damaged power cables. Damaged parts must be exchanged immediately by an authorized service center.
- **Risk of property damage!** — Do not disassemble the device. In the event of a defect, please contact your dealer. The dealer will contact the service center and can send the device in to be repaired, if necessary.

- **Do not expose the device to high temperatures!** Use only the supplied power adapter. Do not short-circuit the device or throw it into a fire. Excessive heat or improper handling could trigger a short circuit, a fire or an explosion.
- **Do not interrupt an ongoing data connection to a computer before all data has been transferred!** This could lead to data loss for which the manufacturer is not liable.

CAUTION

RISK OF EXPLOSION IF BATTERY IS REPLACED BY AN INCORRECT TYPE.

Disposal of a battery into fire or a hot oven, or mechanically crushing or cutting of a battery, can result in an explosion.

Leaving a battery in an extremely high temperature environment can result in an explosion or the leakage of flammable liquid or gas.

A battery subjected to extremely low air pressure may lead to an explosion or the leakage of flammable liquid or gas.

Notes on Cleaning

Turn off the camera. Clean the eyepieces and/or lenses only with a soft, lint-free cloth, (e.g. microfiber cloth). To avoid scratching the lenses, use only gentle pressure with the cleaning cloth. Only use a dry cloth to clean the exterior of the device. To avoid damaging the electronics, do not use any cleaning fluid. Clean the protective case after each use with clear, clean water and dry it thoroughly.

Disposal



Dispose of the packaging materials properly, according to their type, such as paper or cardboard. Contact your local waste-disposal service or environmental authority for information on the proper disposal.



The integrated battery must only be removed for disposal. Opening the device housing can damage the unit. Drain the battery completely before disposal. Remove all the screws in the housing and open the device housing. Remove the connections to the battery and remove it. Cover the open contacts with tape and package the battery in such a way that it cannot shift in the packaging.



CAUTION: Changes or modifications not expressly approved by the party responsible for compliance could void the user's authority to operate the equipment. Note: This equipment has been tested and found to comply with the limits for a Class B digital device, pursuant to part 15 of the FCC Rules. These limits are designed to provide reasonable protection against harmful interference in a used in accordance with the instructions, may cause harmful interference to radio communications. However, there is no guarantee that interference will not occur in a particular installation. If this equipment does cause harmful interference to radio or television reception, which can be determined by turning the equipment off and on, the user is encouraged to try to correct the interference by one or more of the following measures:

- Reorient or relocate the receiving antenna.
- Increase the separation between the equipment and receiver.
- Connect the equipment into an outlet on a circuit different from that to which the receiver is connected.
- Consult the dealer or an experienced radio/TV technician for help.

This device complies with Part 15 of the FCC Rules. Operation is subject to the following two conditions: (1) this device may not cause harmful interference, and (2) this device must accept any interference received, including interference that may cause undesired operation.

FCC SAR statement

This equipment complies with FCC radiation exposure limits set forth for an uncontrolled environment. End user must follow the specific operating instructions for satisfying RF exposure compliance. This transmitter must not be co-located or operating in conjunction with any other antenna or transmitter.

The portable device is designed to meet the requirements for exposure to radio waves established by the Federal Communications Commission (USA). These requirements set a SAR limit of 1.6 W/kg averaged over one gram of tissue. The highest SAR value reported under this standard during product certification for use when properly worn on the body.

What's Included

1

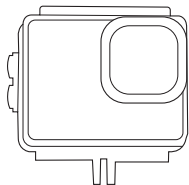

2



3



4

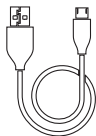

5



6



7

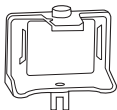

8

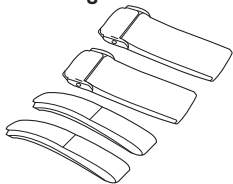

9



10



11



12



13



What's Included

1. Waterproof Case
2. 4K Wifi Waterproof Action Camera
3. Rechargeable Battery
4. USB Cable
5. Remote
6. Handlebar/Pole Mount
7. Frame Mount
8. Straps
9. Release Buckle Mount w/Thumb Screw
10. Short Pivot Mount w/Thumb Screw
11. Adapter
12. Flat Adhesive Mount
13. Extra Adhesive Pads

Meet the 4K Camera

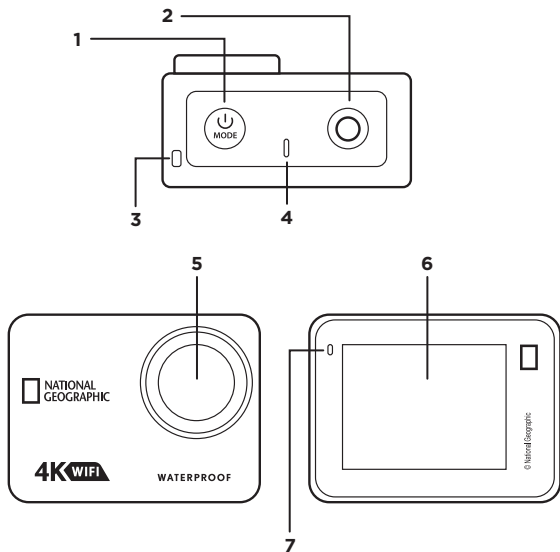

1. Power/Mode Button
2. Shutter/Select Button
3. Lanyard Hole
4. Power On/Functioning Indicator

5. Camera Lens
6. 2.0" Display Screen
7. Charging Indicator

Meet the 4K Camera

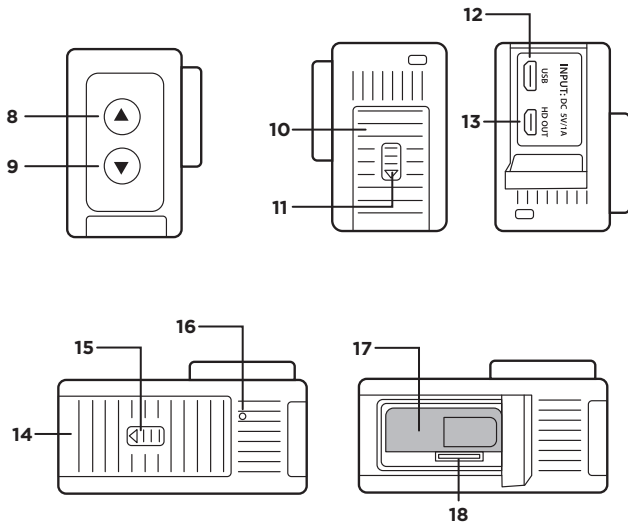

- 8. Up Button
- 9. Down Button
- 10. HD Out/USB Door
- 11. HD Out/USB Door Release Button

- 12. USB Port
- 13. HD Out Port
- 14. Battery Door
- 15. Battery Door Release Button
- 16. Microphone
- 17. Battery
- 18. MicroFlash Card Slot

Camera Functions

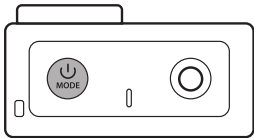

Power Button Functions

- Press and hold the Power button for 2 seconds to turn on and off the camera.
- Press the Power button to switch between Video, Photo modes and Settings.
- Acts as a back function on some menus.

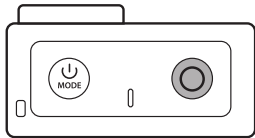

Shutter/Select Button Functions

- Shutter function for video and photo modes.
- Acts as select in Settings.

LED Indicators

- Top of camera LED will show red when the camera is powered on.
- Back of camera LED will show red during charging and will turn off once battery is fully charged.

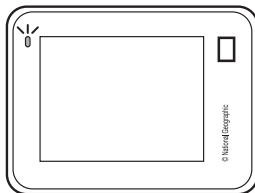
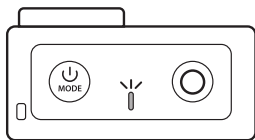

Camera Functions

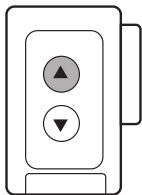

Up Button Functions

- In Video Mode, press and hold to turn On/Off Wifi.
- In Photo Mode, press and hold to zoom in.
- Moves through Settings.

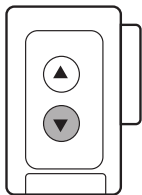

Down Button Functions

- In Video Mode, press and hold to turn On/Off Remote function.
- In Photo Mode, press and hold to zoom out.
- Moves through Settings.

Setting Up The Camera

Charging Camera

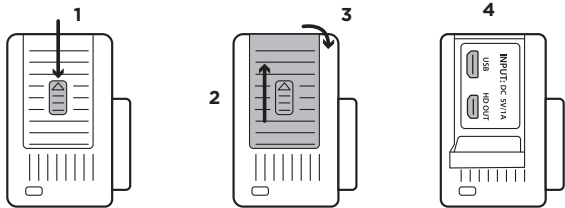

1. Press and hold button.
2. Slide door up.
3. Open door.
4. USB(top)/HD Out(bottom) Ports



WARNING: Your camera's body is designed to be waterproof. Make sure to correctly close the doors to avoid any damages.

To charge your camera, connect to a USB charger with the provided USB cable. If you are using a computer, you can plug the device into your computer and select Charging Mode on the screen.

It takes about 2 to 4 hours for the battery to fully charge. The camera status light will turn off when it is done.

Note: Camera will power on when connected with the USB cable. You can use the camera when charging or it can be powered off.

Setting Up The Camera

Replacing Rechargeable Battery

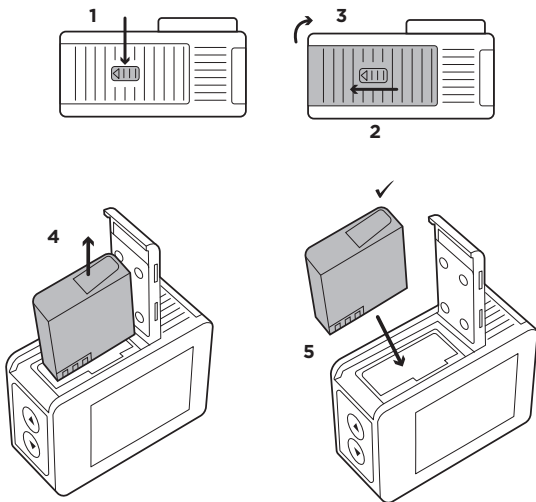

1. Press and hold button.
2. Slide battery door.
3. Open battery door.
4. Use the tab to pull out the battery.
5. Insert battery as shown with the (+/-) terminals facing the screen.



WARNING: Your camera's body is designed to be waterproof. Make sure to correctly close the doors to avoid any damages.

See page 35 for important battery information.

Setting Up The Camera

MicroFlash Card Setup

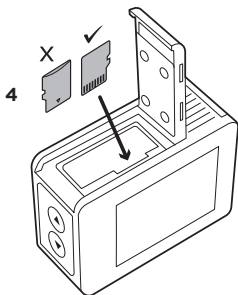
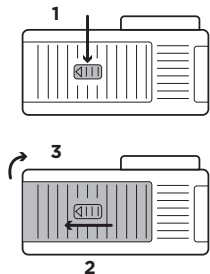

1. Press and hold button.
2. Slide battery door.
3. Open battery door.
4. Insert MicroFlash card correctly as shown. You can eject the card by lightly pressing it into the slot and then releasing. The card will pop out.



WARNING: Your camera's body is designed to be waterproof. Make sure to correctly close the doors to avoid any damages.

Your camera requires a MicroFlash Card (card not included) UHS-I Class 3 or higher. For best performance, use brand name memory cards that meet these requirements:

- **microSD, microSDHC, or microSDXC**
- **UHS-I Speed Class 3 minimum**
- **Capacity up to 128GB**

Please turn off the camera before inserting or removing the memory card. When the memory card is first used, please make sure that the memory card is formatted first and keep your card in good condition by reformatting it regularly after all media is saved first.

*See page 5 for important MicroFlash card information.
Check the card manufacturer's guidelines to see your card's acceptable temperature range and other important information.*

Using the Remote Control

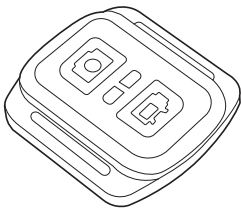

Your remote should already be paired to your camera. When using your remote you can choose between two functions.



Photo Mode

To take a picture you can simply press the red camera button on your remote. If you are in video mode, you can switch to photo mode simply by pressing the camera button and the system will switch automatically and take a photo.



Video Mode

To start recording you should press the grey video button on your remote. To stop recording simply press the button again. If you are in photo mode already if you press the video button it will automatically switch from photo mode to video mode and start recording.

Please note: The remote control operates off of a CR2025 3V battery.

Overview of Modes

There are 3 camera modes: Video Mode, Photo Mode, and Playback & Setting Mode. Press and hold the **POWER/MODE** button for 2 seconds. The camera beeps while the camera status light is on. When information appears on the LCD display your camera is on.

To cycle through modes, press the **MODE** button and the modes will appear in the following order.

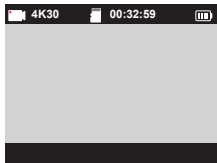

Video Mode



Photo Mode

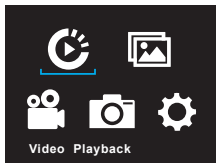

Settings

Overview of Modes

Cycle through the modes by pressing the **MODE** button until you see the settings screen. Use the **DOWN** button to select the desired settings or playback function and press the **SHUTTER/SELECT** button to confirm. The **MODE** button can be used to go back to the main settings screen.

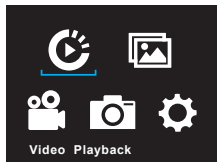

Video Playback

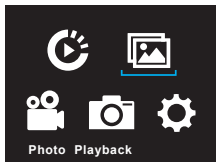
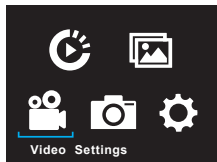

Photo Playback



Video Settings

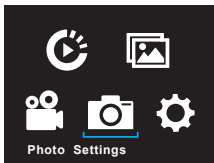
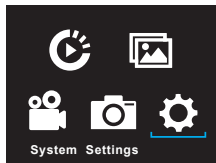

Photo Settings



System Settings

Using Your Camera - Video Mode

To record video, verify the camera is in desired Video Setting option and set the desired video resolution, if the Video icon in your camera's LCD is not showing, press the **MODE** Button repeatedly to the Video Setting menu and select the desired option, such as Loop Video/Time-lapse Video/Slow Motion/Fast Motion etc.

To Start Recording:

To press the Shutter Button. The camera's red Functioning Indicator LED will flash and a red dot will show on the screen while recording.

To Stop Recording:

To press the Shutter Button. The camera Functioning Indicator LED stop flashing and the red dot disappear on the screen to indicate recording has stopped

Note:

- FAT32 format Micro SD card stops recording when the storage of each file is over 4 GB and starts to record again on a new file
- This camera automatically stops recording when the battery is out of power. Your video will saved before the camera powers off. The video will not be saved, and even the video will be damaged, if the batter is took out or loss power during recording.
- Due to the battery's characteristics and environmental temperature requirements, such as high temperatures can cause the battery to expand. In high temperature environments, especially in the summer, when you use this camera as a dash camera, we strongly recommend that you remove the battery and use the car power directly, but when the car's engine is turned off, the camera will immediately turn off, the date&time set and last video recorded will not be saved
- This camera automatically stops recording when the SD card is full, if the looping record function is turn off.

Using Your Camera - Video Mode

Verify the camera is in Video Setting Mode, press the Shutter button to enter the Video Settings menu. Then press the **UP** or **DOWN** button repeatedly to cycle through the options, and press the Shutter button to select the desired option. To exit, press the **MODE** button again.

Video Resolution:

4K 60fps / 4K 30fps
2.7K 60fps / 2.7K 30fps
1080P 120fps / 1080P 60fps
720P 120fps / 720P 240fps

Default setting is 4K 30fps.

Note:

- When capturing video at high resolution or high frame rates such as 4K 60fps, the camera may become hot and consume more power, which is normal.
- If you capturing video at a high frame rates over 60fps, EIS will not be available automatically.
- If you capturing video at 4K 60fps, Loop Video will not be available automatically.
- FAT32 format Micro SD card stops recording when the storage of each file is over 4GB and starts to record again on a new file.

EV(Exposure Value): -3 ~ +3

By default, your camera uses the entire image to determine the appropriate exposure level. However, EV lets you select an area that you want the camera to prioritize when determining exposure. This setting is particularly useful in shots where an important region might otherwise be over- or underexposed. When you change this setting, the LCD display immediately shows you the effect on your image. If you change modes, the camera returns to using the entire scene to determine the correct level of exposure.

EIS (Electronic Image Stabilization) : On/Off

This camera is equipped EIS function with 6-axis gyroscope to detect motion changes. When the camera tilts, moves, shakes, the sensor use image cross-border compensation algorithm to compensate the change and produce stable

Using Your Camera - Video Mode

videos, especially in activities with relatively small angle (about 6 degrees) but fast motion including cycling, motorcycling, and hand-held uses.

Note:

- EIS does not support 1080P 60fps/720P 120fps video resolution.
- If you turn on EIS, Loop Video, Time Lapse Video, TL Duration and Slow Motion will not be available automatically.

Loop Video : Off / 1min / 3min/ 5min

When the micro SD card is full, the new files will cover the old one if loop recording is on.

Note:

- FAT32 format Micro SD card stops recording when the storage of each file is over 4GB and starts to record again on a new file.
- If you select Loop Video, Time-Lapse Video, TL Duration will not be available automatically.

Time-Lapse Video: Off / 1Sec / 3Secs / 5Secs / 10Secs / 30Secs / 1min

Default setting is off.

Time Lapse Video creates video from frames captured at specific intervals. This option lets you capture a time lapse event and immediately view or share it as a video. Select 3 seconds means recording 3 seconds to get one frame per second. For example: If you select 4K/30FPS and 3 secs, you need to record 90secs, then you can get 1 sec video for 4K/30FPS.

Note:

- Time Lapse Video is captured without audio.
- If you select Time-Lapse Video, Loop Video will not be available automatically.

TL Duration: Unlimited/5Min / 10Min /15Min / 20Min/ 30Min / 60Min

Continuously creates Time Lapse Video at specific duration.

Note: If you want to set Time Lapse Duration, please turn on Time Lapse Video first.

Using Your Camera - Video Mode

FOV(Filed of View): Wide/Medium/Narrow

Default setting is Wide.

FOV refers to how much of the scene (measured in degrees) can be captured through the camera lens.

Auto Low Light: On / Off

Default setting is Off.

Auto Low Light mode will automatically adjust the brightness in low light conditions to achieve the best low light performance.

Date Stamp: Off / Date / Date & Time

If you turn on Date Stamp, this camera adds date/time stamp to the videos you record. If you turn off Date Stamp, this camera will not add date/time stamp to the videos you record.

Using Your Camera - Photo Mode

Verify the camera is in Photo Setting Mode, press the Shutter button to enter the Photo Settings menu. Then press the **UP** or **DOWN** button repeatedly to cycle through the options, and press the Shutter button to select the desired option. To exit, press the **MODE** button again.

To capture photo, verify the camera is in desired Photo Setting option and set the desired photo resolution, if the photo icon in your camera's LCD is not showing, press the Mode Button repeatedly to the Photo Setting menu and select the desired option such as Time-lapse Photo/Burst Photo/Self Timer/Long Exposure etc.

To capture a photo:

In the Photo mode, Press the Shutter Button. The camera will emit the camera shutter sound.

To capture Time-Lapse Photo series

Verify the camera is selected desired Time Lapse Photo mode, Press the Shutter Button, The camera will trigger continuous shooting at the set interval and TL duration, the camera will emit shutter sound each time a photo is taken. To stop Time Lapse Photo, Press the Shutter Button again.

To capture a Burst Photo series:

Verify the camera is selected desired Burst Photo option, Press the Shutter Button, the camera will emit shutter sound each time a photo is taken.

To capture a Self Timer Photo:

Verify the camera is selected desired Self Timer option, Press the Shutter Button, the camera initiates countdown and emit shutter sound each time a photo is taken.

To capture a Long Exposure Photo:

Verify the camera is selected desired Long Exposure option, Press the Shutter Button, the camera initiates BEEP and emit a shutter sound as soon as the photo is taken.

Using Your Camera - Photo Mode

Note:

Time Lapse Photo, Burst Photo, Self Timer and Long Exposure can not be selected at the same time, if you select any one of them, the other three will automatically close.

Adjusting Camera Zoom:

The Zoom function lets you adjust how close or far away the subject appears in your photo. The default is no zoom. Zoom function is available in Photo Mode.

1. Turn on your camera.
2. Enter Photo Mode.
3. Press and hold **UP/DOWN** button to adjust the zoom level.

Photo Resolution: 20M/14M/10M/8M

Default setting is 14M

Long Exposure: Off / 1sec / 2sec / 5sec / 8sec / 30sec / 60sec

Default setting is off.

Long Exposure is an exposure method that selects a slow shutter speed. Long exposures can make dark scenes clearer and get fantastic effects. Especially in night vision scenes such as starry sky or city night traffic, the camera can also take fantastic photos at night.

Note:

- If you select Long Exposure function, Time Lapse Photo, TL Duration, Burst Photo and Self Timer will not be available automatically.

ISO: Auto / 100 / 200 / 400 / 800 / 1600 / 3200

Default setting is Auto.

ISO determines the camera's sensitivity to light, and creates a trade-off between brightness and resulting image noise. Image noise refers to the degree of graininess in the image. In low light, higher ISO values result in brighter images, but with greater image noise. Lower values result in lower image noise, but darker images. When you change this setting, the display immediately shows you the effect on your image.

Using Your Camera - Photo Mode

EV(Exposure Value): -3 ~ +3

By default, your camera uses the entire image to determine the appropriate exposure level. However, EV lets you select an area that you want the camera to prioritize when determining exposure. This setting is particularly useful in shots where an important region might otherwise be over- or underexposed. When you change this setting, the LCD display immediately shows you the effect on your image. If you change modes, the camera returns to using the entire scene to determine the correct level of exposure.

Time Lapse Photo: Off / 3Sec / 5Sec / 10Sec / 30Sec / 1min

Time Lapse Photo captures a series of photos at specified intervals. Use this mode to capture photos of any activity, then choose the best ones later.

Note: If you select Time Lapse Photo, Burst Photo, Self Timer and Long Exposure will not be available automatically.

TL Duration: Unlimited / 5Mins / 10Mins / 15Mins / 20Mins / 30Mins / 60Mins

Default setting is Unlimited.

Note: If you want to select TL Duration, please turn on Time Lapse Photo first.

Burst Photo: Off / 3 Photos / 7 Photos / 15 Photos / 30 Photos

Default setting is off.

Continuous shooting can take up to 30 photos in a certain amount of time, making it ideal for fast-moving events.

• If you select Burst Photo function, Time Lapse Photo, TL Duration and Long Exposure will not be available automatically.

Self Timer: 2sec / 10sec

A Self Timer gives a delay between pressing the shutter release and the shutter's firing. It is most commonly used to let photographers to take a photo of themselves (often with family).

Note:

• If use Self Timer function, Time Lapse Photo, TL Duration and Long Exposure will not be available automatically.

Using Your Camera - Photo Mode

Date Stamp: Off / Date / Date & Time

If you turn on Stamp, this camera adds stamp to the photos you take.

If you turn off Stamp, this camera will not add stamp to the photos you take.

Using the WiFi App

The WiFi App lets you control your camera remotely using a smart phone or tablet. Features include full camera control, live preview, playback and sharing of selected content and more.

Connect to the iSmart DV APP:

1. Download iSmart DV app to your mobile device from the Apple App Store or Google Play.
2. Turn on the camera, then hold the **UP** button for 2 seconds to turn on WiFi.

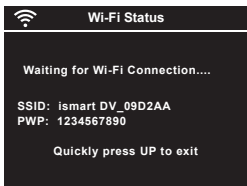

3. Turn on WiFi Setting of your mobile device, connect to the WiFi SSID **“iSmart DV”** followed by six random characters.
4. Enter the password: **“1234567890”**
5. Open the app **“iSmart DV”** on your smart phone or tablet.
6. Tap **“Add new camera”**
7. Tap **“WiFi Connect”**

Note: Press and hold the **UP** button for 2 seconds again if you want to turn off WiFi.

Downloading and Share Your Content:

1. Open the “iSmart DV” app.
2. Tap “Albums icon” at the left corner of the bottom screen.
3. Select files in “Photos” or “Videos” at the top of the screen.
4. Tap “Download icon” at the right corner of the bottom screen to download
5. Save or Share your content.

Using the WiFi App

The iSmart DV App is compatible with smart phone and tablet listed below:

For Apple iOS:

iPhone6(plus), 6s(plus), 7 (above iOS12) and iPhone Air & Mini (above iOS12)

For Android

Android 4x Quad-Core devices (above Android 7.0)

Note:

- The camera WiFi is a point to point signal source, which supports only one telephone connection at one time and does not support two or more phones. If two phones turn on WiFi at the same time, one phone is successfully connected to the camera's WiFi, and the other will no longer connect to the camera, or even interfere with the transmission of the signal.
- The camera WiFi bandwidth is relatively narrow, and its signal will be affected by distance, other signals, electromagnetic waves, obstacles and other factors. 2 to 5 seconds signal delay is normal. WiFi distance is about 5-10 meters.
- When the phone and camera connect through WiFi, the power of the camera will increase. The camera's temperature will rise rapidly, and the consumption of camera batteries will also increase. This is a normal phenomenon.
- Since many kinds of phones in the market, and the phone system is constantly updated, iSmart DV app needs time to synchronize timely updates.
- If you find your phone can not connect the camera's WIFI, please confirm that your connection is correct, if yes, and still can not connect. Please delete the WiFi SSID of the camera in your phone WiFi setting and reconnect. If necessary, you can also delete the iSmart DV app from your phone and re-download and re-install it.

Media Playback

Playing Back on Camera:

1. Enter Video or Photo playback mode. If the SD card contains a lot of content, it might take a minute for it to load.
2. Press the **UP/DOWN** Button to scroll through the video or photo files.
3. Press Shutter Button to open video or photo in full-screen view.
4. To return to the file list, press **MODE** Button.
5. To exit the Playback mode, press **MODE** Button again.

Playing Back on TV:

1. Turn on the TV
2. Connect the Mini HD Out end to the port on camera and HD Out end to HD Out port on the TV.
3. Select the right input source on the TV.
4. Turn on the camera after a while, you can preview the camera from TV.
5. Setting your camera into the video/photo playback mode.
6. Select the desired content to playback.

Note:

- If the camera is connected TV with HD Out cable, the camera do not support to take videos or photo, only for Playback.
- HD Out cable is not included in the standard package, you will need buy an extra HD Out cable.

Playing Back on Computer:

To play back your video and photos on a computer, you must first transfer these files to a computer. Transferring also frees up space on your micro SD card for new content. To offload files to a computer using a card reader (sold separately) and your computer's file explorer, connect the card reader to the computer, then insert the micro SD card. You can then transfer files to your computer or delete selected files on your card. Note that you must use a card reader to offload photos or audio files. With this method, playback resolution depends on the resolution of the device and its ability to play back that resolution.

Media Playback

Note:

- 4K requires a high data transmission stream. If you playback 4K video file through a card reader, you may not be able to obtain sound playback. In order to get better playback results, it is strongly recommended to copy the 4K video directly to the computer to playback.
- This camera might not be compatible with the files from different solution camera or other device.
- The quick time player is a good compatibility with MOV format video files. We strongly recommend using the Quick Time Player to play back video files on your computer.

Delete File on Camera:

1. Verify the camera is in Video or Photo Playback menu. If your micro SD card contains a lot of content, it might take a minute for it to load.
2. Press the **UP** or **DOWN** Button to locate the file you want to delete.
3. Press and hold the **UP** Button for seconds. The screen shows **“Delete File”**.
4. Press the **UP** or **DOWN** Button to locate the desired option: **“Single File”** or **“All Files”**, then Press Shutter Button to select the desired option.
5. Press the **UP** or **DOWN** Button to locate the desired option: **“Yes / No”**.
6. If you select **“Yes”**, then Press Shutter Button to deleted the file you want. If you select **“No”**, then Press Shutter Button to back the playback mode.

System Settings

Verify the camera is in System Setting Mode, press the Shutter button to enter the System Settings menu. Then press the **UP** or **DOWN** button repeatedly to cycle through the options, and press the Shutter button to select the desired option. To exit, press the **MODE** button again.

Frequency: 50Hz/60Hz

Default setting is 50 Hz.

Sound: Shutter / Boot-up / Beep / Volume

Shutter: On / Off

Sets the camera's shutter sound.

Boot-up: On / Off

Sets the your camera's power on sound.

Beep: On/Off

Sets the camera's operation sound.

Volume: 0 / 1 / 2 / 3

Sets the volume of your camera's record sound.

AE Meter: Center / Multi / Spot

Default setting is Center

In photography, the metering mode refers to the way in which a camera determines exposure. Cameras generally allow the user to select between center, average or spot metering modes. The different metering modes allow the user to select the most appropriate one for use in a variety of lighting conditions

AWB: Auto / Daylight / Cloudy / Incandescent / Fluorescent / Snorkeling / Snow Mode

AWB (Auto White Balance) lets you adjust the color temperature of videos and photos to optimize for cool or warm lighting conditions. When you change this setting, the LCD display immediately shows you the effect on your image.

Note:

- Snorkeling mode provides color correction while capturing footage in blue water or clear freshwater at depths of 5 to 33ft (1.5 to 10m)
- Snow mode can suppress overexposure in high-brightness environments such as snow field or beach.

System Settings

Effect: Standard / Black & White / Natural / Negative / Retro / Brightness Contrast

Default setting is Normal.

LDC (Lens Distortion Correction): On / Off

Default setting is off.

Turn on Distortion Correction, it can correct the image distortion.

Date & Time: YYYYMMDD 00:00:00

The date and time are automatically updated when you connect your camera to the iSmart DV app. However, you can manually change these settings, if needed.

Note:

- If the battery is removed from the camera for an extended period of time, the date and time will be reset automatically.

Screen Saver: Off / 1min / 3min / 5min

Turns off the LCD display after a period of inactivity to save battery life. To turn on the LCD display again, press any button on the camera.

Upside Down: On/Off

This setting determines the orientation of setting menu.

Power Off: Off / 1min / 3min / 5min

Powers off your camera after a period of inactivity to save battery life.

WiFi: On/Off

Default setting is off.

RF Remote: On/Off

Default setting is off.

Driving Mode: Off/On

1. If you turn on car mode and connect camera with car charger, the camera will turn on automatically and start recording if you start your car's engine and the

System Settings

camera will turn off and stop recording if you Turn off the car's engine.

2. When the micro SD card is full, the new files will cover the old one.

Note:

- Must use 5V 1A output car charger.
- Using as a dash cam, we suggest to turn on the Loop Video, Driving Mode and Screen Saver at same time.

Language: English/Simplified Chinese/Traditional Chinese/Japanese/Italian/Spanish/Portuguese/Deutsch/French/Polish/Russian/Korean

Sets the language that appears on the camera.

Format: Yes/No

To keep your micro SD card in good condition, reformat it on a regular basis. Reformatting erases all of your content, so be sure to offload your photos and videos first. To reformat your card, press the mode button to enter system setting, then press down button several times to enter Format > Format Card? > YES.

Reset: Yes/No

This option resets all settings to their default values.

Version: Model / Version / Number / Dated

You can check the model, software version and updated time of your camera.

Note:

- Software version is the main information of firmware upgrade, troubleshooting and after-sales. If necessary, please provide the software version information to our after-sales team so that we can serve you in time.

Memory Card: Capacity / Free Space

Card Info option let you check the capacity and free space of your micro SD card.

System Settings/Charging Battery

Recommended Micro SD:

The card in the list meets the required card speed for 4K video recording, it is highly recommended to use it first.

Note:

If the camera's battery is removed, all settings will be restored to the factory default settings.

Charging the Battery:

1. Connect the camera to USB power supply (5V 1A commended).
2. The charging status light remains ON while the battery is charging.
3. The charging status light will turn OFF when the battery is fully charged.

Notes:

- Charging time: 4-hours for 5V 1A power supply
- Please make sure the camera is shuttled down while charging.
- Remove the battery before using as a dash camera and use 5V/1A brand-name car charger.

Maximizing Battery Life:

If the battery reaches 0% while recording, the camera saves the file and powers off.

To maximize battery life, follow these guidelines when possible:

- Turn off Wireless Connections
- Capture video at lower frame rates and resolutions
- Use Screen Saver setting.

Battery Storage and Handling:

- Do not store in temperature above 140°F/60°C.
- Avoid exposing your camera to very cold or very hot temperatures. Low or high temperature conditions may temporarily shorten the battery life or cause the camera to temporarily stop working properly. Avoid dramatic changes in temperature or humidity when using the camera, as condensation may form on or within the camera.
- Do not dry the camera or battery with an external heat source such as a microwave oven or hair dryer.

System Settings/Charging Battery

- Damage to the camera or battery caused by contact with liquid inside the camera is not covered under the warranty.
- Do not store your battery with metal objects, such as coins, keys or necklaces. If the battery terminals come in contact with metal objects, this may cause a fire.
- Do not make any unauthorized alterations to the camera. Doing so may compromise safety, regulatory compliance, performance, and may void the warranty.
- Please do not throw the camera or its battery to the garbage, find a specific recycling point for it.

WARNING:

- Do not drop, disassemble, open, crush, bend, deform, puncture, shred, microwave, incinerate or paint the camera or battery.
- Do not insert foreign objects into the battery opening on the camera.
- Do not use the camera or the battery if it has been damaged - for example, if cracked, punctured or harmed by water. Disassembling or puncturing the battery can cause an explosion or fire.

Waterproof

To ensure it is ready to go rain or shine wherever the action takes you, the camera is waterproof up to 19.5 feet (6 meters) on its own and up to 131 feet (40 meters) when inside the waterproof case. **Please read Underwater Usage on page 38.**



Camera Only = 19.5 ft / 6 m waterproof

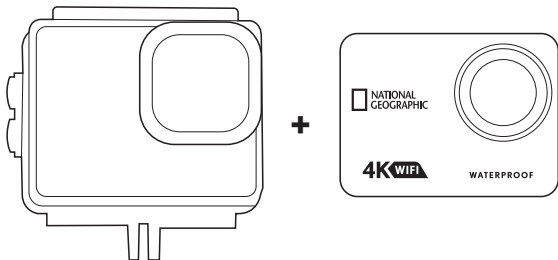

Case and Camera = 131 ft / 40 m waterproof



WARNING: Your camera's body is designed to be waterproof. Make sure to correctly close the doors to avoid any damages.

Underwater Usage

In order to ensure the waterproof performance of the camera, please carefully refer to the operation and maintenance precautions as following. The camera is not waterproof due to improper operation and improper maintenance, which is not covered by the warranty.

WARNING:

1. Make sure to check whether the silicone pads on the battery waterproof cover and USB waterproof cover are clean before using underwater. Otherwise it will affect the camera's waterproof ability, and a single hair or sand will cause leakage!
2. Make sure to check whether the silicone pad on the battery waterproof cover and USB waterproof cover are intact. Damage to the silicone pad will cause water leakage!
3. Make sure to check whether the screws on the battery waterproof cover and USB waterproof cover silicone pad are fixed in place. Otherwise it will cause leakage!
4. Make sure that the battery waterproof cover and USB waterproof cover are tightly closed before using underwater. If not, the camera will not be waterproof.
5. Avoid jumping into water at high speed with camera. Otherwise, the impact may result in water leakage.
6. DO NOT use the camera in a hot spring or expose the product directly to high temperatures over 45°C. High temperature may cause deformation of the waterproof seal on the camera body and lose its waterproof function.
7. Keep it safe from falling and dropping. Falling and drop will cause damage to the watertight seal and a hydrophobic coating on the camera body and the camera is not waterproof.
8. The microphone hole on the bottom of the camera has built in waterproof material. DO NOT remove the waterproof material or poke the holes. Otherwise, the camera will no longer be waterproof.
9. Clean the camera with clean water after using underwater. Allow it to dry naturally before using again.
10. This camera is not waterproof unless the battery cover and the USB cover are closed.

Mounting The Camera

Stick On Mounting

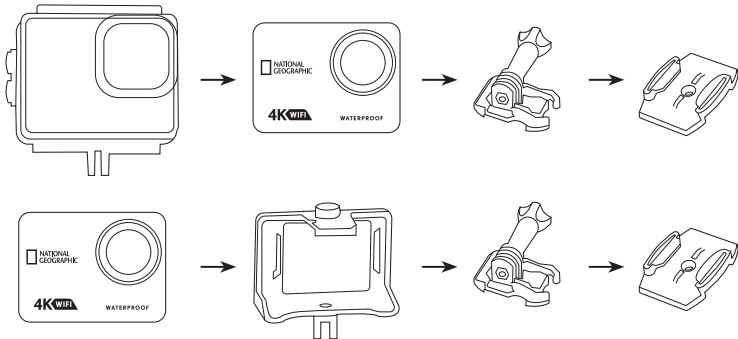

Pole/Bar Mounting

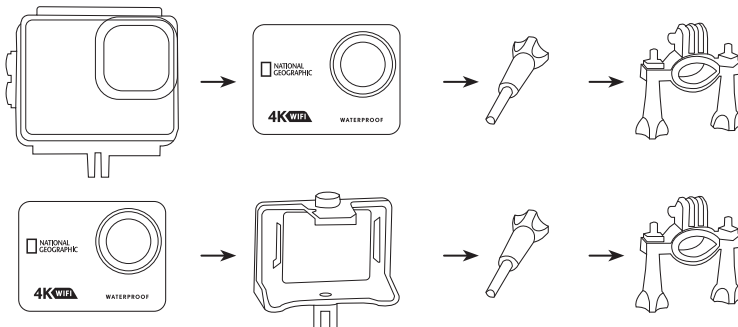

See page 8 for What's Included.

Video Specifications

See page 21 on *How to Change Settings*.

Video Mode

Rec Resolution	<ul style="list-style-type: none">• 4K 60FPS• 4K 30FPS• 2.7K 60FPS• 2.7K 30FPS• 1080P 120FPS• 1080P 60FPS• 720P 240FPS• 720P 120FPS
----------------	--

Exposure	-3 / -2 / -1 / 0 / +1 / +2 / +3
----------	---------------------------------

Electronic Image Stabilization (EIS)	On / Off
--------------------------------------	----------

Loop Video	Off / 1 min / 3 min / 5min
------------	----------------------------

Time Lapse Video	1 / 3 / 5 / 10 / 30 / 60 seconds
------------------	----------------------------------

Time Lapse Duration	Unlimited / 5 / 10 / 15 / 20 / 30 / 60 minutes
---------------------	--

Field of View (FOV)	Wide / Medium / Narrow
---------------------	------------------------

Auto Low Light	On / Off
----------------	----------

Date Stamp	Off / Date / Date & Time
------------	--------------------------

Photo Specifications

See page 24 on How to Change Settings.

Photo Mode

Rec Resolution

- 20MP
- 14MP
- 10MP
- 8MP

Long Exposure

Off / 1 / 3 / 5 / 8 / 30 / 60 seconds

ISO

Auto / 100 / 200 / 400 / 800 / 1600 / 3200

Exposure

-3 / -2 / -1 / 0 / +1 / +2 / +3

Time Lapse Photo

1 / 3 / 5 / 10 / 30 / 60 seconds

Time Lapse Duration

Unlimited / 5 / 10 / 15 / 20 / 30 / 60 minutes

Burst Photo

Off / 3 / 7 / 15 / 30 photos

Self Timer

Off / 2 / 10 seconds

Date Stamp

Off / Date / Date & Time

Camera Tech Specs

CPU	Sunplus V35AX
Sensor	Sony 386
Lens	170 degrees wide-angle
Screen	2.0-in LCD
App	iSmart DV; Andriod & iOS
Waterproof(w/o case)	up to 19.5ft (6m)
Waterproof(w/ case)	up to 131ft (40m)
Languages	English/Simplified Chinese/Traditional Chinese/ Japanese/Italian/Spanish/Portuguese/ Deutsch/French/Polish/Russian/Korean
Photo Format	JPEG
Video Format	MOV
Video Compression Format	H.264
Storage	Micro Flash up to 128 GB
Speaker & Mic	Built-in

Camera Tech Specs

Battery	Rechargeable Li-ion 3.7V  1050mAH
Recording Time	About 60 minutes (at 4K)
Charging Time	About 2 - 4 hours
WiFi	2.4G
USB Connection Port	Micro USB 2.0
HD Out Connection Port	Micro HD Out
Computer Support	Windows and Mac



©2021 National Geographic Partners LLC. All rights reserved.
NATIONAL GEOGRAPHIC and Yellow Border Design are trademarks of the
National Geographic Society, used under license.

©2021 Explore Scientific, LLC
1010 S. 48th Street, Springdale AR 72762.
All rights reserved. Made in China.
explorescientific.com | 866.252.3811

Contents, colors and specifications may vary.