



NG700AZ

70 MM TELESCOPE W/ SLOW-MOTION ALT-AZIMUTH MOUNT INSTRUCTION MANUAL

SPECIFICATIONS

OPTICAL DESIGN	ACHROMATIC REFRACTOR
MAGNIFICATION (WITH 2X BARLOW LENS)	27 - 72X (54 - 144X)
FRONT LENS (CLEAR APERTURE)	70 MM
FOCAL LENGTH	700 MM
STANDARD EYEPIECES	PLÖSSL WIDE FIELD 26 MM AND 9.7 MM
FINISH	BLACK
ACCEPTS EYEPIECE BARREL	31.7 MM (1.25")
VIEWFINDER	RED DOT
MOUNTING	SLOW-MOTION ALT-AZIMUTH MOUNT



 **WARNING:**
SUN HAZARD – Never look directly at the sun
with this device.

 **WARNING:**
CHOKING HAZARD – Small parts.
Not for children under 3 years.

 **WARNING:**
Contains button or coin cell battery.
Hazardous if swallowed – see instructions.



SUN WARNING

WARNING: NEVER ATTEMPT TO OBSERVE THE SUN WITH THIS DEVICE! OBSERVING THE SUN - EVEN FOR A MOMENT - WILL CAUSE INSTANT AND IRREVERSIBLE DAMAGE TO YOUR EYE OR EVEN BLINDNESS. EYE DAMAGE IS OFTEN PAINLESS, SO THERE IS NO WARNING TO THE OBSERVER THAT THE DAMAGE HAS OCCURRED UNTIL IT IS TOO LATE. DO NOT POINT THE DEVICE AT OR NEAR THE SUN. DO NOT LOOK THROUGH THE DEVICE AS IT IS MOVING. CHILDREN SHOULD ALWAYS HAVE ADULT SUPERVISION WHILE OBSERVING.

SAFETY WARNINGS

READ AND FOLLOW THE INSTRUCTIONS, SAFETY RULES, AND FIRST AID INFORMATION.

• **RESPECT PRIVACY:** WHEN USING THIS DEVICE, RESPECT THE PRIVACY OF OTHER PEOPLE. FOR EXAMPLE, DO NOT USE THEM TO LOOK INTO PEOPLE'S HOMES.

• **CHOKING HAZARD:** CHILDREN SHOULD ONLY USE DEVICE UNDER ADULT SUPERVISION. KEEP PACKAGING MATERIALS LIKE PLASTIC BAGS AND RUBBER BANDS OUT OF THE REACH OF CHILDREN AS THESE MATERIALS POSE A CHOKING HAZARD.

• **RISK OF BLINDNESS:** NEVER USE THIS DEVICE TO LOOK DIRECTLY AT THE SUN OR IN THE DIRECT

PROXIMITY OF THE SUN. DOING SO MAY RESULT IN A PERMANENT LOSS OF VISION.

• **RISK OF FIRE:** DO NOT PLACE DEVICE, PARTICULARLY THE LENSES, IN DIRECT SUNLIGHT. THE CONCENTRATION OF LIGHT RAYS COULD CAUSE A FIRE.

• **DO NOT DISASSEMBLE THIS DEVICE.** IN THE EVENT OF A DEFECT, PLEASE CONTACT YOUR DEALER. THE DEALER WILL CONTACT THE CUSTOMER SERVICE DEPARTMENT AND CAN SEND THE DEVICE IN TO BE REPAIRED IF NECESSARY.

• **DO NOT SUBJECT THE DEVICE TO TEMPERATURES EXCEEDING 60 °C (140 °F).**



• **DISPOSAL:** KEEP PACKAGING MATERIALS, LIKE PLASTIC BAGS AND RUBBER BANDS, AWAY FROM CHILDREN AS THEY A POSE A RISK OF SUFFOCATION. DISPOSE OF PACKAGING MATERIALS AS LEGALLY REQUIRED. CONSULT THE LOCAL AUTHORITY ON THE MATTER IF NECESSARY AND RECYCLE MATERIALS WHEN POSSIBLE.

BUTTON/COIN BATTERY WARNING



WARNING:

This product contains a Button or Coin Cell Battery. A swallowed Button or Coin Cell Battery can cause internal chemical burns in as little as two hours and lead to death. Dispose of used batteries immediately. Keep new and used batteries away from children. If you think batteries might have been swallowed or placed inside any part of the body, seek immediate medical attention.

Instruction Manual and Downloadable Planisphere Visit:

www.exploreone.com/pages/product-manuals





Parts Overview

1. 70mm Objective Lens
2. Slow-motion Alt-Azimuth Mount
3. Tripod with Accessory Tray
4. Optical Tube Assembly (OTA) with Dew Shield
5. Focus Wheel
6. 1.25" Diagonal
7. 1.25" Wide Field Plössl Eyepieces (9.7mm and 26mm)
8. 1.25" 2x Barlow Lens
9. Red Dot Viewfinder



Telescope Terms To Know:

Diagonal: A mirror that deflects the ray of light 90 degrees. With a horizontal telescope tube, this device deflects the light upwards so that you can comfortably observe by looking downwards into the eyepiece. The image in a diagonal mirror appears upright, but rotated around its vertical axis (mirror image).

Focal length: Everything that magnifies an object via an optic lens has a certain focal length. The focal length is the length of the path the light travels from the surface of the lens to its focal point. The focal point is also referred to as the focus. In focus, the image is clear. In the case of a telescope, the focal length of the telescope tube and the eyepieces are used to determine magnification.

Lens: The lens turns the light that falls on it around in such a way so that the light gives a clear image in the focal point after it has traveled a certain distance (focal length).

Eyepiece: An eyepiece is a system made for your eye and comprised of one or more lenses. In an eyepiece, the clear image that is generated in the focal point of a lens is captured and magnified still more.

Magnification: The magnification corresponds to the difference between observation with the naked eye and observation through a magnifying device like a telescope. If a telescope configuration has a magnification of 30x, then an object viewed through the telescope will appear 30 times larger than it would with the naked eye. To calculate the magnification of your telescope setup, divide the focal length of the telescope tube by the focal length of the eyepiece.

How To Set Up

Note: We recommend assembling your telescope for the first time in the daylight or in a lit room so that you can familiarize yourself with assembly steps and all components.

(Fig 1)

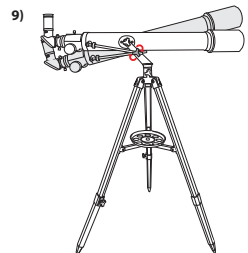
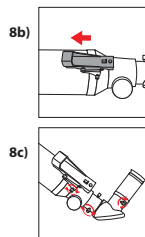
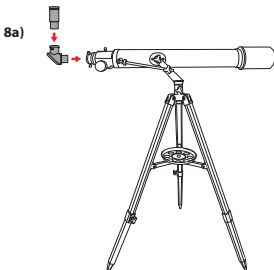
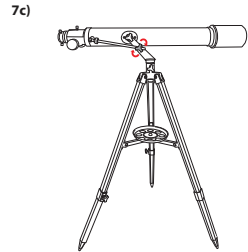
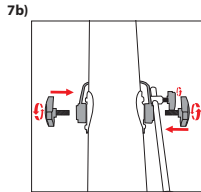
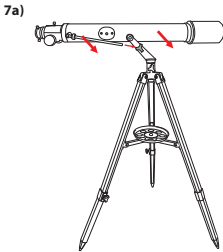
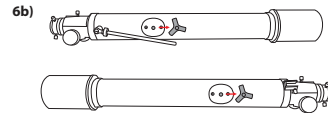
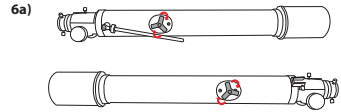
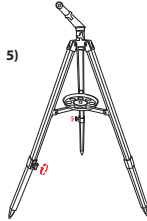
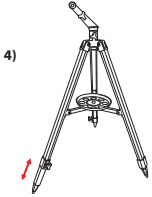
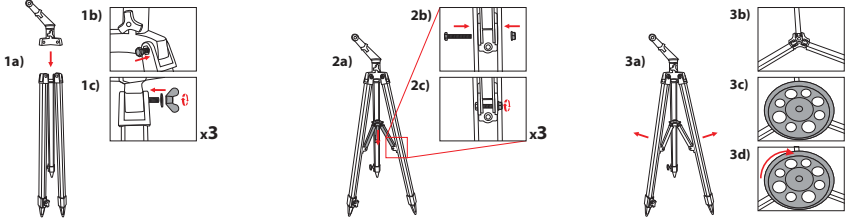

(Fig 2)

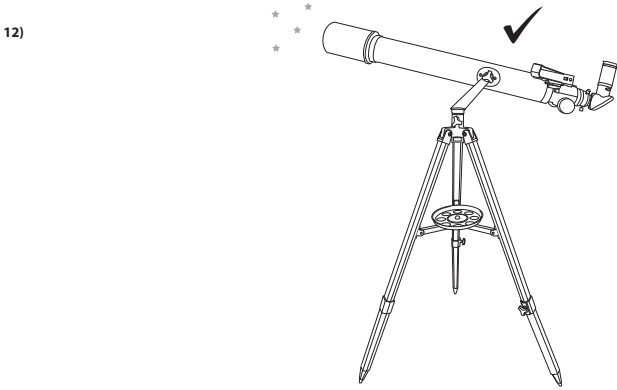
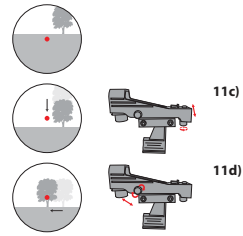
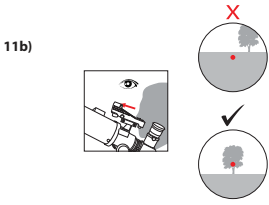
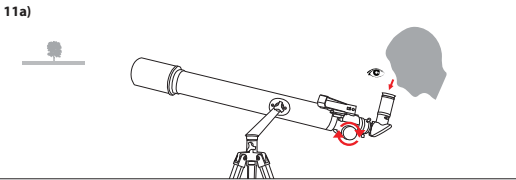
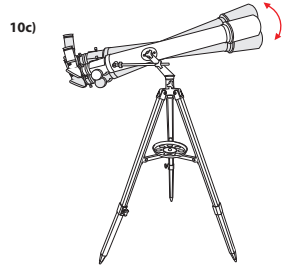
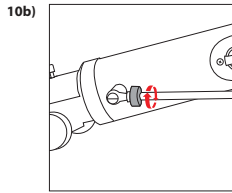
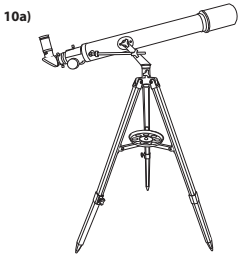

Using/Aligning the Red Dot Viewfinder:

The viewfinder is powered by a CR-2032 battery that is included. Before using the viewfinder for the first time, remember to remove the plastic insulator that is blocking the battery from connecting.

For The Viewfinder To Be Effective, It Must Be Aligned. To do this:

- Insert the 26 mm eyepiece into the diagonal and power on the viewfinder by sliding the switch on its right side to an "On" position.
- Point the eyepiece at an easy to identify target like a telephone pole that is approximately 200 yards away. Center the object in the eyepiece. Lock the telescope into place by tightening the locating screws on both the altitude fine adjustment and the altitude axis (Fig 1, #9 & Fig 2, #10).
- Without moving the telescope, position the red dot using the two adjustment screws so that it shares the same view as the one in your eyepiece. The front screw will move the viewfinder up and down, and the other will move it side to side. Your viewfinder is now aligned.

Note: To preserve battery life, don't forget to turn off the viewfinder after use.

Using your telescope:

After you have aligned your viewfinder, you are ready to start observing! Put the 26 mm eyepiece into the diagonal to get the widest field of view. This wider field of view will make it easier to locate and track objects. Loosen the locating screws for the altitude fine adjustment and the altitude axis to move the scope up, down and side to side until your target comes into view in the eyepiece. When you have the object well placed in the eyepiece, you can re-tighten the locating screws and fix the position of the telescope (Fig 1, #9 & Fig 2, #10).

It is important to remember that the rotation of the Earth means objects will move out of your eyepiece fairly quickly. Once you have found and focused on your desired target, you can track it as it journeys across the night sky using the panhandle.

For a closer look at an object, you can insert the 9.7 mm eyepiece. The magnification will increase from 27x to 72x. For a more closer look at an object, you can insert the 2x Barlow lens. The magnification will increase to 54x for the 26 mm eyepiece and 144x for the 9.7 mm eyepiece.

Cleaning:

Your telescope is a precision optical device and keeping the optics free of dust and dirt is crucial for optimal performance. To clean the lenses (objective and eyepiece) use only a photo-grade soft brush or a lint-free cloth, like a microfiber cloth. Do not press down too hard while cleaning, as this might scratch the lens. Ask your parents to help if your telescope is really dirty, if necessary, the cleaning cloth can be moistened with an optical glass cleaning fluid and the lens wiped clean using very little pressure. Do not use harsh detergents!

Make sure your telescope is always protected against dust and dirt. After use, leave it in a warm room to dry off before storing. 6

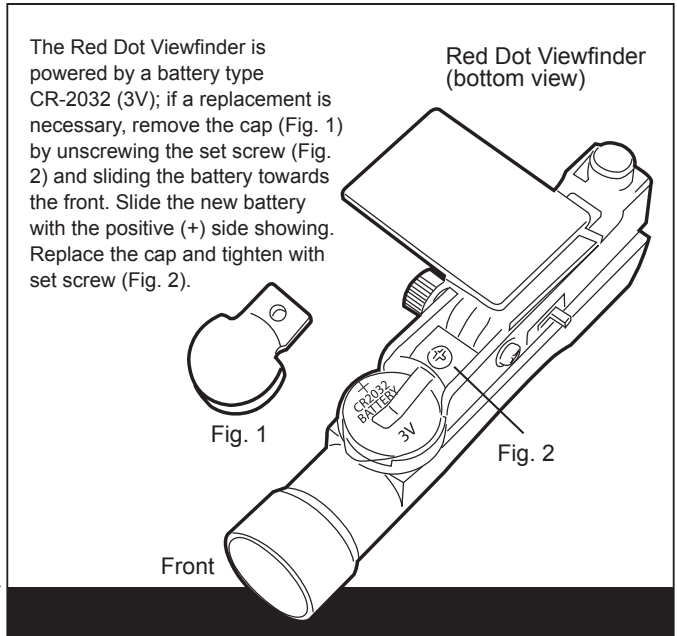

Possible Objects for Observation:

Terrestrial objects

Take note of the examples below, including Mount Rushmore and the golf course. Start with the 26 mm eyepiece and focus until the image is clear. After mastering the 26 mm eyepiece, switch to the 9.7 mm eyepiece and practice scanning and focusing until the image is clear. Choose several terrestrial objects to practice focusing on, but never point your telescope at or near the sun, or you risk blindness.

The Moon

Diameter: 3,476 km

Distance: Approximately 384,401 km

The Moon is the Earth's only natural satellite, and it is the second brightest object in the sky (after the Sun). Although it is our closest neighbor, a lot of people have never really taken a good long look at the Moon. With your telescope, you should be able to see several interesting lunar features. These include lunar maria, which appear as vast plains, and some of the larger craters. The best views will be found along the terminator, which is the edge where the visible and cloaked portions of the Moon meet.

Orion Nebula (M 42)

M 42 in the Orion constellation

Right ascension: 05:35 (Hours: Minutes)

Declination: -5:22 (Degrees: Minutes)

Distance from Earth: 1,500 light years

Located about 1,500 light years from Earth, the Orion Nebula (Messier 42, abbreviation: M 42) is the brightest diffuse nebula in the sky – visible with the naked eye, and a worthwhile object for telescopes of all types and sizes, from the smallest field glass to the largest earthbound observatories and the Hubble Space Telescope. When talking about Orion, we're actually referring to the main part of a much larger cloud of hydrogen gas and dust, which spreads out over half of the Orion constellation. The expanse of this enormous cloud stretches several hundred light years.

Ring Nebula (M 57)

M 57 in the Lyra constellation

Right ascension: 18:53 (Hours: Minutes)

Declination: -33:02 (Degrees: Minutes)

Distance from Earth: 2,400 light years

The famous Ring Nebula M 57 in the constellation of Lyra is often viewed as the prototype of a planetary nebula; it is one of the magnificent features of the Northern Hemisphere's summer sky. Recent studies have shown that it is probably comprised of a ring (torus) of brightly shining material that surrounds the central star (only visible with larger telescopes), and not of a gas structure in the form of a sphere or an ellipsoid. If you were to look at the Ring Nebula from the side, it would look like the Dumbbell Nebula (M27). When viewed from Earth, we are looking directly at the pole of the nebula.

Dumbbell Nebula (M 27)

M 27 in the Fox constellation

Right ascension: 19:59.6 (Hours: Minutes)

Declination: +22:43 (Degrees: Minutes)

Distance from Earth: 1,360 light years

The Dumbbell Nebula (M 27) in Fox was the first planetary nebula ever discovered. On July 12, 1764, Charles Messier discovered this new and fascinating class of objects. We see this nebula almost directly from its equatorial plane. If we could see the Dumbbell Nebula from one of its poles, we would see the shape of a ring, and we would see something very similar to what we know as the Ring Nebula (M 57). In reasonably good weather, we can see this object well even with low magnifications.

**Images are illustration purposes only and do not reflect actual views seen. Quality of your image may vary depending upon atmospheric conditions and location.*

Terrestrial Images

f=26 mm

f=9.7 mm



The Moon

f=26 mm

f=9.7 mm



Orion Nebula M 42

f=26 mm

f=9.7 mm



Ring Nebula in Lyra Constellation M 57

f=26 mm

f=9.7 mm



Dumbbell Nebula in Fox Constellation M 27

f=26 mm

f=9.7 mm



Troubleshooting Guide:

Problem	Solution
No picture	Remove dust protection cap and sun-shield from the objective opening.
Blurred picture	Adjust focus using focus ring.
No focus possible	Wait for temperature to balance out.
Bad quality	Never observe through a glass surface such as a window.
Viewing object visible in the finder, but not through the telescope	Align finder to telescope (see instructions)
Despite using star diagonal prism the picture is "crooked"	The star diagonal prism should be vertical in the eyepiece connection.



©2018 National Geographic Partners LLC. All rights reserved.
 NATIONAL GEOGRAPHIC and Yellow Border Design are trademarks of the
 National Geographic Society, used under license.

©2018 Explore Scientific, LLC.
 1010 S. 48th Street, Springdale AR 72762
 All rights reserved. explorescientificusa.com | exploreone.com | 866.252.3811
 Made in China

CONFORMS TO THE SAFETY REQUIREMENTS OF ASTM F963