



8+

88-90100



RUMBLIN' ROBOTS

INSTRUCTIONS



RUMBLIN' ROBOTS

Engineer a CHALLENGING GAME with your Family and Friends

Welcome to the amazing world of one of Explore Science! Explore Science is a D.I.Y (do-it-yourself) educational science kit that provides useful knowledge about simple physics, and is suitable for children of 8 years old and up.

In this series, we focus on building relationship, socializing with family and friends by various kinds of interactive and scientific games. Come challenge your friends and have fun at the same time. Besides, "You'll be amazed" to find what you can learn as the activity enables you to learn realistic concept of basic physical theory.

It is a great way to develop bonding between your friends and family via building up the educational kit together.

This kit also comes with an Eco-friendly reusable box that is multi-purpose. The box is not only a platform that allows the children to build the experiment, but it is also a safe place as a "storage box" to put and store all the parts. You can carry it anywhere and play anytime you desire.

Connect each game with friends and families with this educational game of science fun!

WARNING: Only for use by children aged 8 years and older.

GLOSSARY

Assembly: A group of machine parts or components that fit together to form a complete unit.

Battery: A consumable for providing electricity. It contains chemicals which will undergo chemical reaction that produces electricity

Motor: A device converts electricity to rotatory mechanical motion.

Power: The energy force or strength generated by a physical system or machine.

Wire: A component which is used in the electronic / electrical industry as a conductor that is used to carry electricity or signals.

WARNING: Adult supervision and assistance is required.

- This unit is only for use by children aged 8 years and older.

- Not suitable for children under age 3 years old due to small part(s) and component(s) - CHOKING HAZARD.

- Read and follow all instructions in the manual before use.

- This toy contains small parts and functional sharp points on components. Keep away from children under age 3 years.

- 2 x AA size batteries are required (not included)

- Please retain the information and this manual for future reference.

- Instructions for parents are included and have to be observed.



WARNING:

This product contains (a) small magnet(s). Swallowed magnets can stick together across intestines causing serious infections and death. Seek immediate medical attention if magnet(s) are swallowed or inhaled.

CAUTION!

Before setting up this unit, please double check and make sure all wiring connections you have made are correct before inserting batteries and switching on the unit as failure may result in damage to components or the unit.

When experiment is finished, make sure the batteries are disconnected and switch off the unit before you clear away the wires. Do not apply any components or parts to the unit other than those provided with this kit.

Do not lock the motor or other moving parts. Otherwise it may cause overheating.

The toy is not to be connected to more than recommended number of power supplies.

BATTERY INFORMATION

Use 2 x AA size batteries (not included)

For best performance, always use fresh batteries and remove batteries when not in use

Batteries must be inserted with the correct polarity

Non-rechargeable batteries are not to be recharged

Re-chargeable batteries are only to be charged under adult supervision

Re-chargeable batteries are to be removed from the toy before being charged

Different types of batteries or new and used batteries are not to be mixed.

Exhausted batteries are to be removed from the toy

The supply terminals are not to be short-circuited

Only batteries of the same or equivalent types are to be used

Do not dispose of the batteries in fire

Do not mix old and new batteries

Do not mix alkaline, carbon zinc and re-chargeable batteries

EXPLANATION

Boxing is a combat sport in which two people throw punches at each other, and achieve victory by either scoring more points or knocking out the opponent. Boxers have to wear gloves for protection, protecting both sides by “softening” the impact.

The stage of boxing matches is called a ring, though this stage is not circular but square. Here are some of the basic rules in modern boxing matches: only punches are allowed. No kick, headbut, throw, bite, or hitting with the elbow or backhand. Only hitting your opponent’s upper part of the body is allowed, excluding the back, the neck, or on the kidney. Hitting below the waist is foul. Boxers have to be standing on their feet. Crouching or ducking below the waist is not allowed.

Though inflicting damage to the opponent is not the goal in boxing matches, it is not uncommon that injuries are caused. Therefore boxing is banned in some countries. And in this kit, you will be free to box with your friends without the concern of getting hurt!

Components

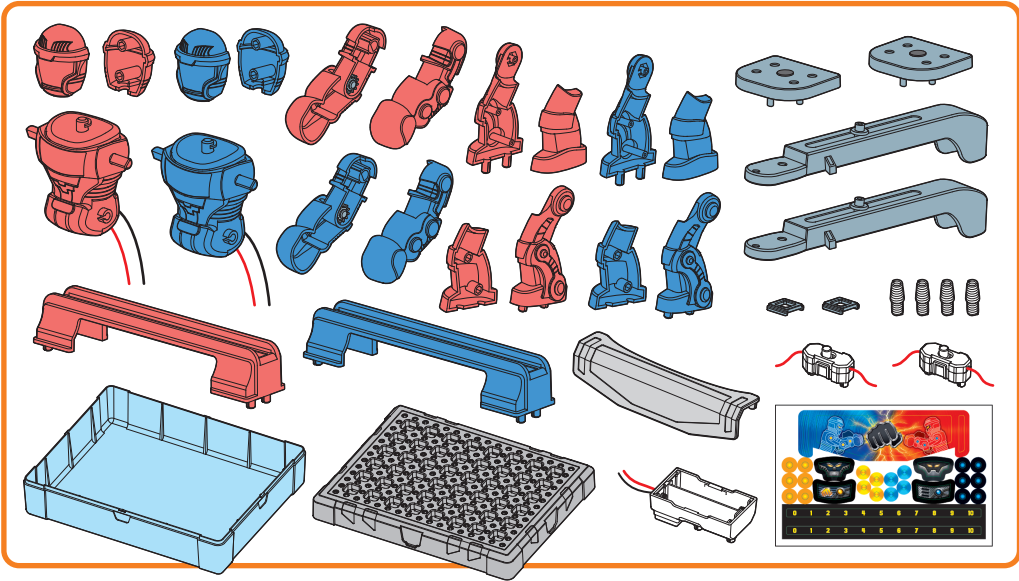

Assembling

01

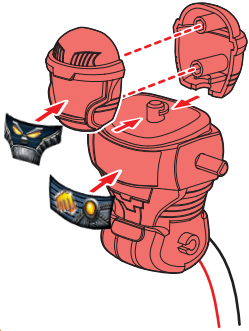

02

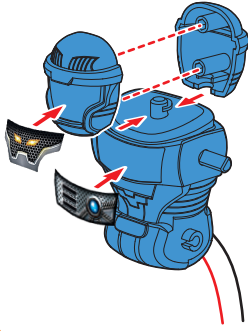

03

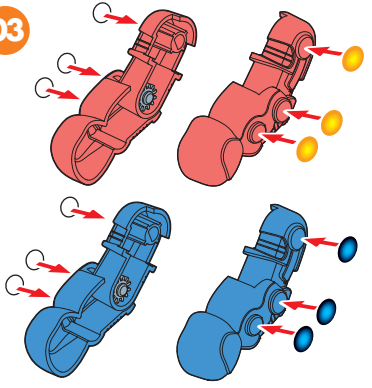

04

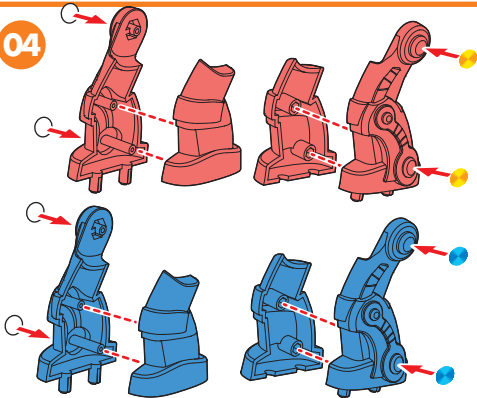

05

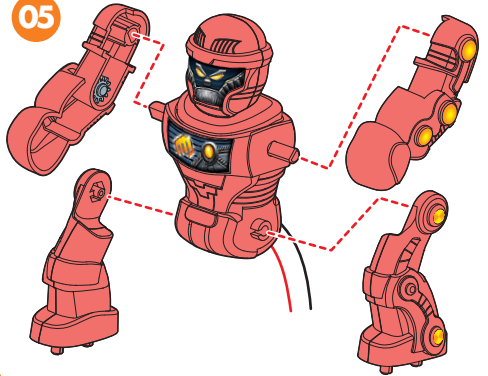

06

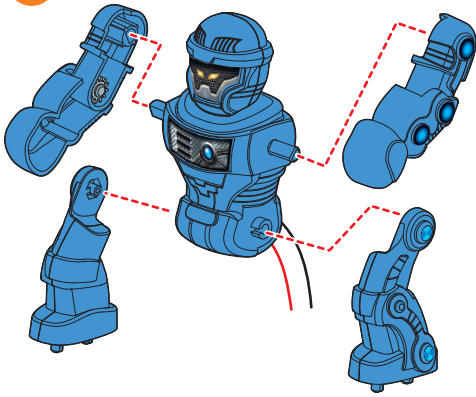

07

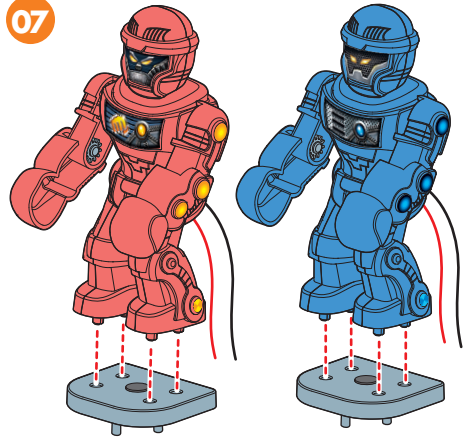

08

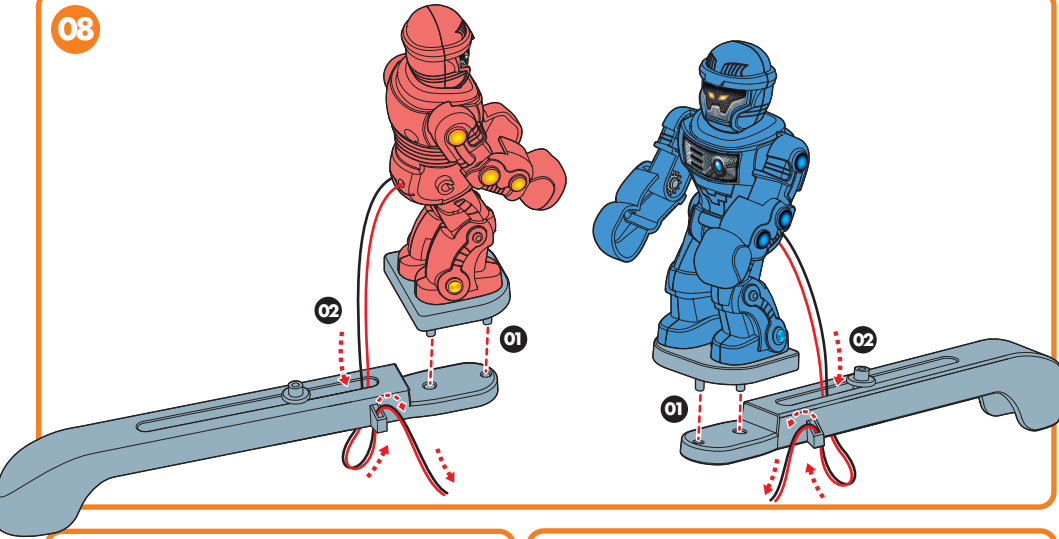

09

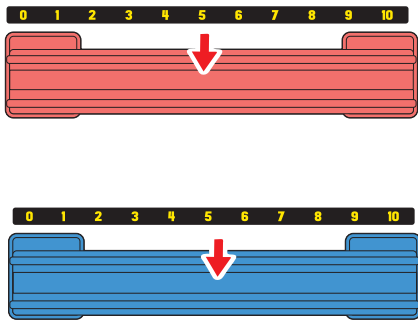

10

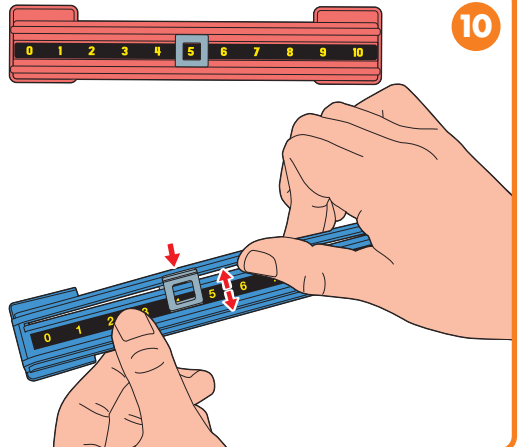

11

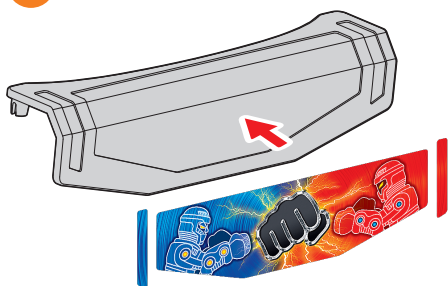

12

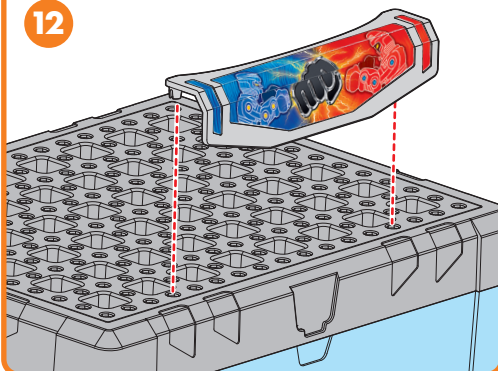

13

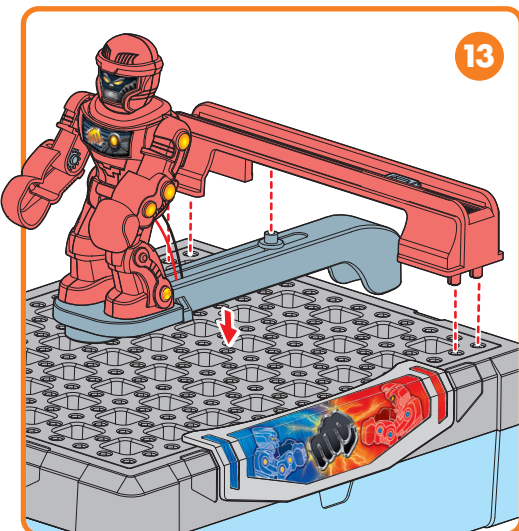

14

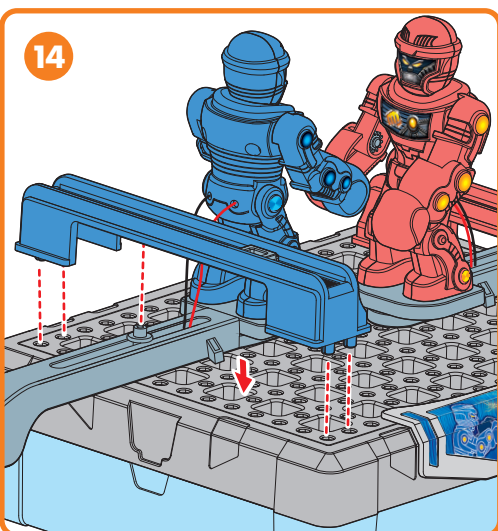

15

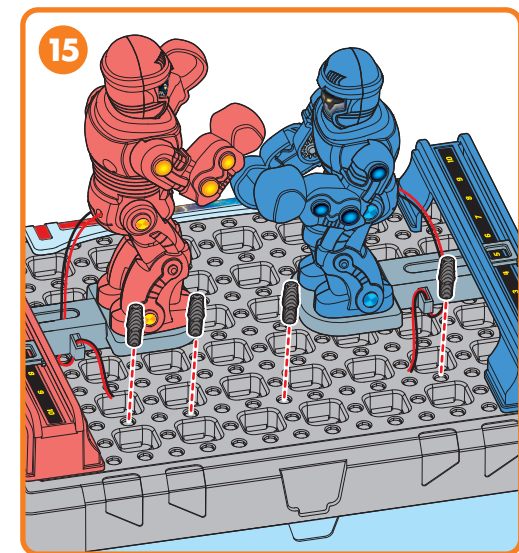

16

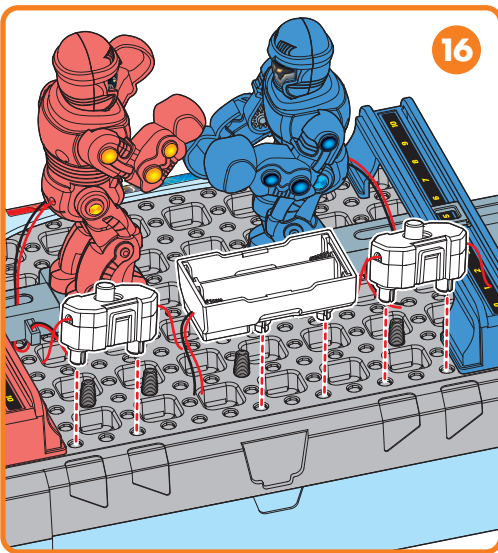

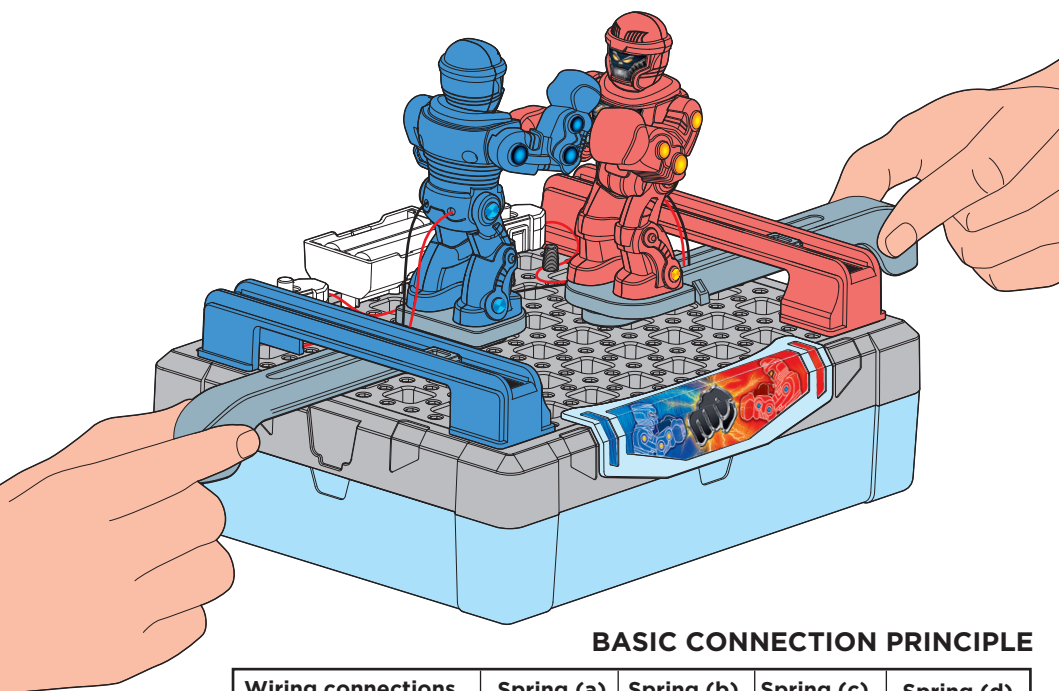
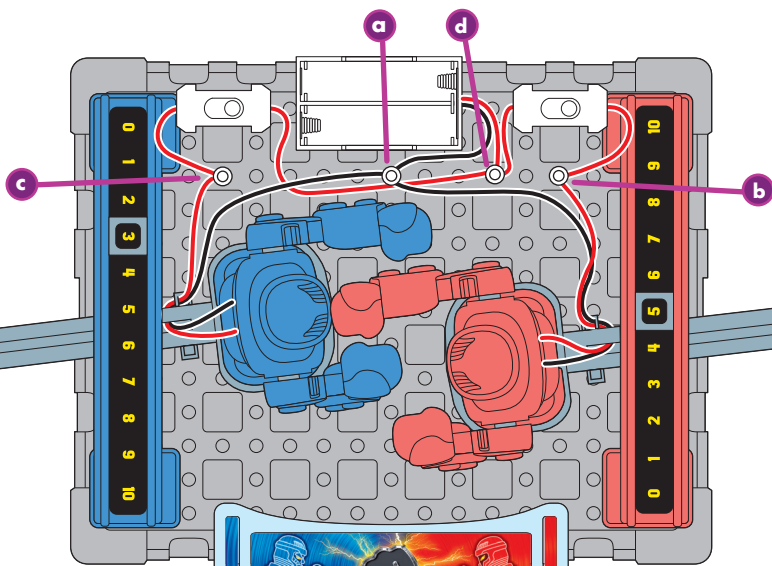

BASIC CONNECTION PRINCIPLE

Wiring connections	Spring (a)	Spring (b)	Spring (c)	Spring (d)
Battery compartment	black			red
ON/OFF Switch (1)		red		red
Red Robo	black	red		
ON/OFF Switch (2)			red	red
Blue Robo	black		red	

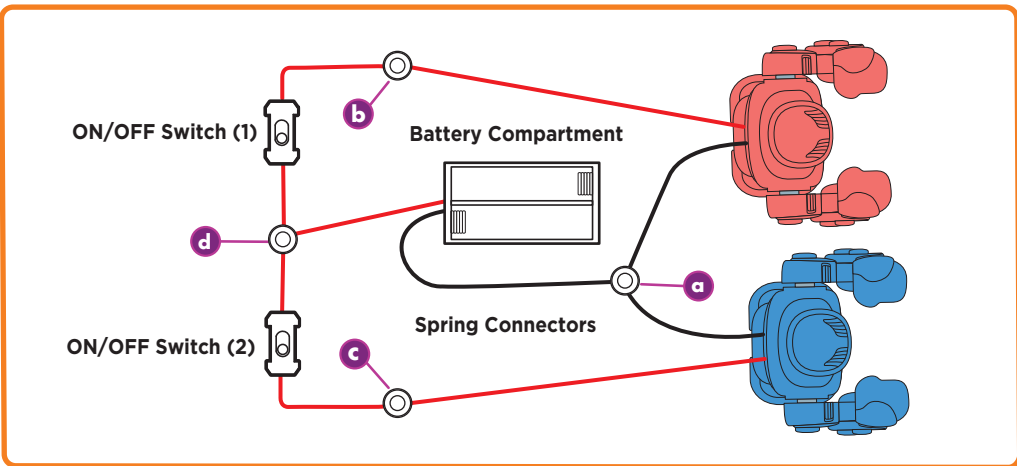

Ensure all wires are correctly connected to the battery terminals and spring connectors as stated wiring sequence and connection. Bend the spring terminal over and insert the exposed shiny conductor part of wire into spring terminal. Make sure the wire is securely connected to spring terminal. If the circuit does not work, you can check the wire and spring terminal connection whether they are not well connected or the insulated plastic part of the wire has been wrongly inserted to spring terminal.

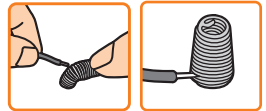

Warning! Do not short-circuit the battery terminals and spring connectors. Otherwise it may cause overheating.

How to play

Insert 2pcs AA size batteries to the battery compartment. Now it is ready to start the bout! Turn the switches ON, and the boxers will come to action! Move forward and backward to avoid the opponent's punches. Dodge left or right and counter! Though moving quickly is a good way to catch your opponent off-guard, you must remember to keep your boxer in a balanced manner to avoid falling down. If you knock down your opponent, you score 1 point! See who can get higher scores to become the champion!

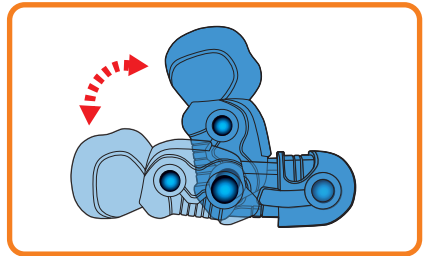

Scoreboard

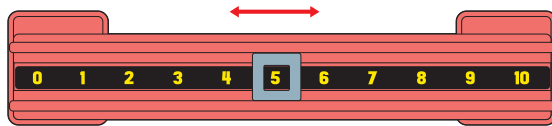

Scoreboard is provided to update and record players' score!

If at any time in the future you should need to dispose of this product please note that waste electrical products should not be disposed of with household waste. Please recycle where facilities exist. Check with your local authority or retailer for recycling advice. (Waste Electrical and Electronic Equipment Directive)

