

HAMP30

FRONT VIEW

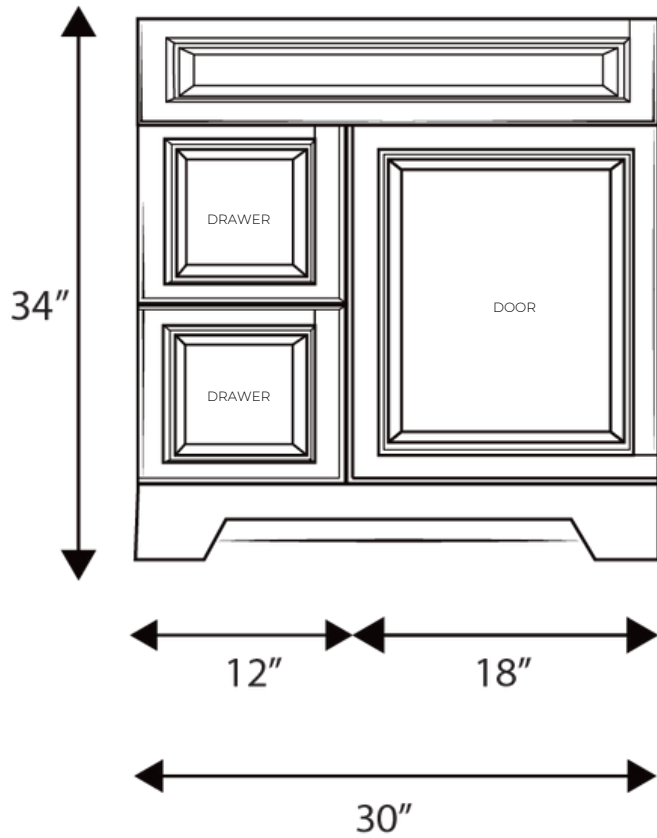

SIDE VIEW

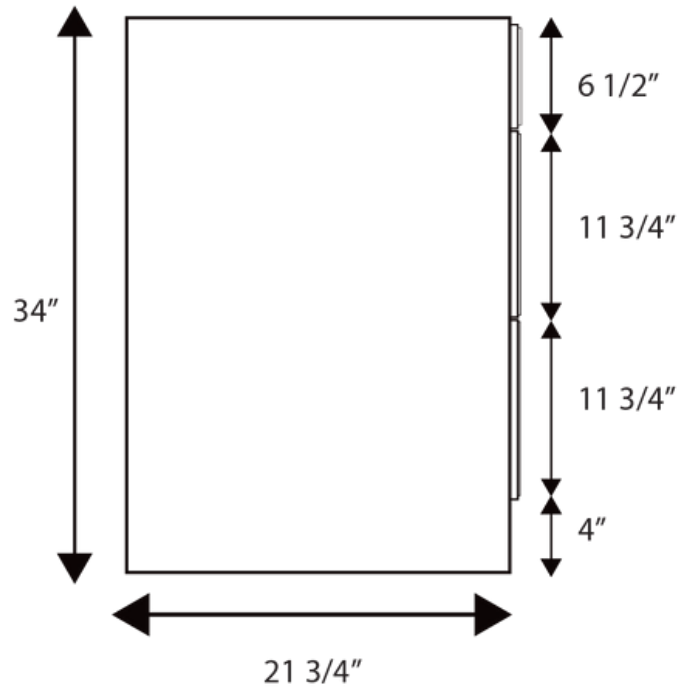

DIMENSIONS

CABINET

WIDTH	30"	762 mm
HEIGHT	34"	864 mm
DEPTH	21.75"	552 mm

COUNTERTOP (2CM THICK)

LENGTH	31"	787 mm
WIDTH	22.5"	571 mm

SINK (INNER)

LENGTH	12.4"	315 mm
WIDTH	18.75"	475 mm
DEPTH	7"	178 mm

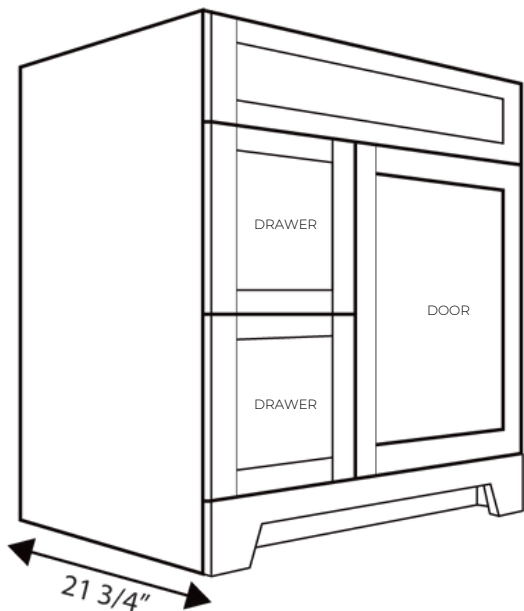

COUNTERTOP

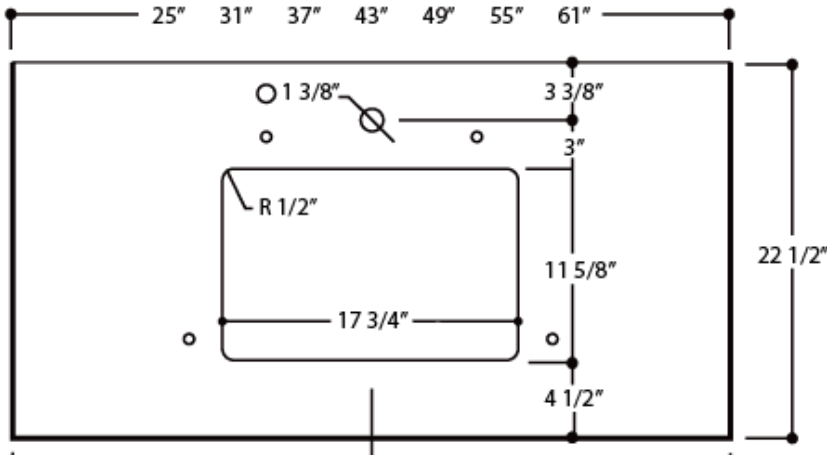

SINK

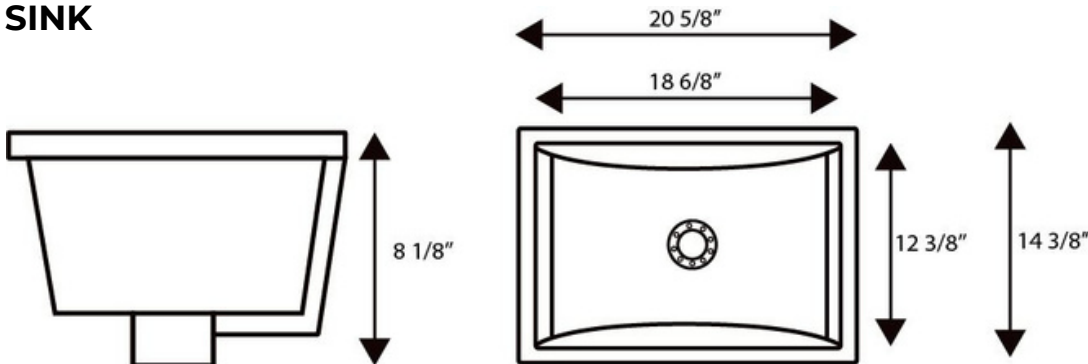

FEATURES

- High-density fiberboard (HDF) cabinet
- 2 operational drawers and 1 doors
- 2cm thick premium countertop
- CUPC approved ceramic sink
- Matching quartz backsplash included
- Universal side-splash included
- 1/2" cabinet filler strip included
- Soft-close full extension drawer slides
- Dovetail drawer construction
- Recessed toe-kick
- Requires minimal assembly